



US00D956462S

(12) **United States Design Patent**
Boychuk

(10) **Patent No.:** **US D956,462 S**
(45) **Date of Patent:** **** Jul. 5, 2022**

- (54) **CABINET PANEL**
- (71) Applicant: **Stephen Boychuk**, Toronto (CA)
- (72) Inventor: **Stephen Boychuk**, Toronto (CA)
- (**) Term: **15 Years**
- (21) Appl. No.: **29/715,290**
- (22) Filed: **Nov. 29, 2019**
- (51) **LOC (13) Cl.** **06-06**
- (52) **U.S. Cl.**
USPC **D6/703**
- (58) **Field of Classification Search**
USPC D6/657, 662, 663, 664, 664.1, 667, 671,
D6/671.1, 671.2, 671.3, 671.4, 703,
D6/703.2, 703.4, 559, 561; D23/286;
D20/42
CPC A47B 17/04; A47B 43/00; A47B 45/00;
A47B 46/00; A47B 47/00; A47B 47/02;
A47B 47/03; A47B 47/04; A47B 47/042;
A47B 47/05; A47B 57/00; A47B 47/045;
A47B 47/047; A47B 67/00; A47B 81/00;
A47B 67/005; A47B 67/02; E05B 65/025
See application file for complete search history.

(56) **References Cited**

U.S. PATENT DOCUMENTS

- 305,286 A * 9/1884 Campbell A47B 47/03
312/263
- D28,666 S * 5/1898 Tabor D6/662
- 840,347 A * 1/1907 Knapp A47B 67/005
312/224
- 873,440 A * 12/1907 Kerr A47B 81/00
312/290
- 955,312 A * 4/1910 Belfi A47B 67/005
312/227
- 2,373,217 A * 4/1945 Allen A47B 67/02
221/44
- 2,424,217 A * 7/1947 Bales A47B 47/03
312/257.1
- D158,930 S * 6/1950 Burgold D6/671.1
- 3,510,187 A * 5/1970 Schreyer A47B 47/03
312/304
- D224,995 S * 10/1972 Harrison D6/561
- 3,813,138 A * 5/1974 Doohan A47B 46/00
312/309
- D243,903 S * 4/1977 Carter D6/671.1

- D258,781 S * 4/1981 Andersson D6/561
- D266,295 S * 9/1982 Zola D6/671.1
- D271,168 S * 11/1983 Antonczyk D6/559
- 4,418,967 A * 12/1983 Winkelman, Jr. ... A47B 47/042
312/107
- D277,150 S * 1/1985 Tebbe D6/671.1
- D280,156 S * 8/1985 Allen D6/555
- D284,243 S * 6/1986 Barber D6/663
- D284,629 S * 7/1986 Hamami D6/561
- 4,635,418 A * 1/1987 Hobgood A47B 47/042
160/135
- D296,285 S * 6/1988 Palka D6/561
- D297,149 S * 8/1988 Johnston D20/42
- D300,487 S * 4/1989 Dyer D6/671.1
- D306,947 S * 4/1990 Sanfilippo D6/559
- D318,582 S * 7/1991 Hollington D6/671.1
- D353,068 S * 12/1994 Goldstein D6/559
- D363,618 S * 10/1995 Cramer D6/671.1
- 5,611,553 A * 3/1997 Schoeman A47B 46/00
280/47.35
- 5,630,512 A * 5/1997 Wells A47B 81/00
206/776
- D458,064 S * 6/2002 List, Jr. D6/703
- D458,483 S * 6/2002 List, Jr. D6/703
- D467,756 S * 12/2002 Mattick D6/671.1
- D479,659 S * 9/2003 Fleckenstein D6/661
- D551,717 S * 9/2007 Diller D20/42
- D590,890 S * 4/2009 King D20/39
- D686,015 S * 7/2013 Arko D6/703
- 8,567,879 B2 * 10/2013 Carter A47B 46/00
312/108
- D701,407 S * 3/2014 Bavuso D6/703
- D830,085 S * 10/2018 Curthelet D6/671
- D846,028 S * 4/2019 Svihilik D20/42
- D874,192 S * 2/2020 Velez D6/671.1
- D897,748 S * 10/2020 Choi D6/705
- D900,521 S * 11/2020 Kim D6/703
- D904,081 S * 12/2020 Hermann D6/671.1
- D920,432 S * 5/2021 Lee D20/42

FOREIGN PATENT DOCUMENTS

- CH 621933 A5 * 3/1981 A47B 67/005
- GB 776863 A * 6/1957 A47B 67/005

OTHER PUBLICATIONS

D506-001 Cream Chevron Doors Cabinet by Pulaski, from colemanfurniture.com, Retrieved Date: Sep. 2, 2021, p. 1, from <https://colemanfurniture.com/d506-001-cream-chevron-doors-cabinet.htm?%7Bkw%7D=keyword&cpn=9105787379> (Year: 2021).*

* cited by examiner

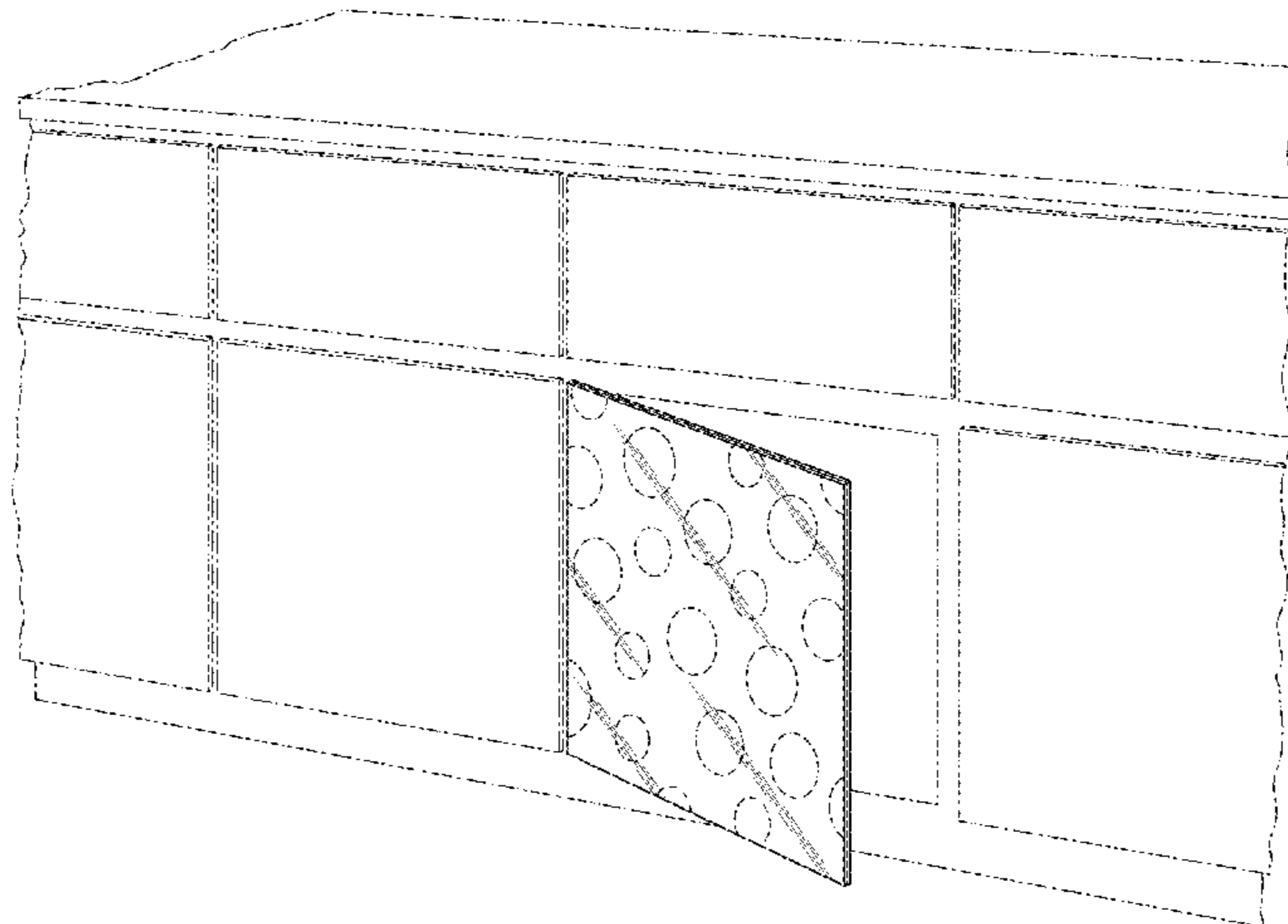

Primary Examiner — Mimosa De

(74) *Attorney, Agent, or Firm* — Dickinson Wright LLP;
Matthew D. Powell

(57) **CLAIM**

The ornamental design for a cabinet panel, as shown and described.

DESCRIPTION

FIG. 1 is a perspective view of the front of a first embodiment of the cabinet panel, in accordance with the design, shown in a cabinet environment;

FIG. 2 is an enlarged elevation view of the front of the cabinet panel of FIG. 1;

FIG. 3 is an enlarged perspective view of the front of the cabinet panel of FIG. 1;

FIG. 4 is an enlarged second perspective view of the front of the cabinet panel of FIG. 1;

FIG. 5 is an enlarged third perspective view of the front of the cabinet panel of FIG. 1;

FIG. 6 is an enlarged elevation view of the right side of the cabinet panel of FIG. 1, the left side of the cabinet panel being identical to the right side;

FIG. 7 is an enlarged plan view of the top side of the cabinet panel of FIG. 1, the bottom side of the cabinet panel being identical to the top side;

FIG. 8 is an enlarged partial view of a portion of the top side of the cabinet panel of FIG. 7, wherein corners are slightly rounded;

FIG. 9 is an enlarged partial view of a portion of the top side of the cabinet panel of FIG. 7, wherein corners are slightly chamfered;

FIG. 10 is an enlarged elevation view of the rear of the cabinet panel of FIG. 1;

FIG. 11 is an elevation view of the front of a second embodiment of the cabinet panel, in accordance with the design;

FIG. 12 is a perspective view of the front of the cabinet panel of FIG. 11;

FIG. 13 is a second perspective view of the front of the cabinet panel of FIG. 11;

FIG. 14 is a third perspective view of the front of the cabinet panel of FIG. 11;

FIG. 15 is an elevation view of the right side of the cabinet panel of FIG. 11, the left side of the cabinet panel being identical to the right side;

FIG. 16 is a plan view of the top side of the cabinet panel of FIG. 11, the bottom side of the cabinet panel being identical to the top side;

FIG. 17 is an enlarged partial view of a portion of the top side of the cabinet panel of FIG. 16, wherein corners are slightly rounded;

FIG. 18 is an enlarged partial view of a portion of the top side of the cabinet panel of FIG. 16, wherein corners are slightly chamfered;

FIG. 19 is an elevation view of the rear of the cabinet panel of FIG. 11;

FIG. 20 is a perspective view of the front of a third embodiment of the cabinet panel, in accordance with the design, shown in a cabinet environment;

FIG. 21 is an enlarged elevation view of the front of the cabinet panel of FIG. 20;

FIG. 22 is an enlarged perspective view of the front of the cabinet panel of FIG. 20;

FIG. 23 is an enlarged second perspective view of the front of the cabinet panel of FIG. 20;

FIG. 24 is an enlarged third perspective view of the front of the cabinet panel of FIG. 20;

FIG. 25 is an enlarged elevation view of the right side of the cabinet panel of FIG. 20, the left side of the cabinet panel being a mirror image of the right side;

FIG. 26 is an enlarged plan view of the top side of the cabinet panel of FIG. 20, the bottom side of the cabinet panel being a mirror image of the top side;

FIG. 27 is an enlarged partial view of a portion of the top side of the cabinet panel of FIG. 26, wherein corners are slightly rounded;

FIG. 28 is an enlarged partial view of a portion of the top side of the cabinet panel of FIG. 26, wherein corners are slightly chamfered;

FIG. 29 is an enlarged elevation view of the rear of the cabinet panel of FIG. 20;

FIG. 30 is an elevation view of the front of a fourth embodiment of the cabinet panel, in accordance with the design;

FIG. 31 is a perspective view of the front of the cabinet panel of FIG. 30;

FIG. 32 is a second perspective view of the front of the cabinet panel of FIG. 30;

FIG. 33 is a third perspective view of the front of the cabinet panel of FIG. 30;

FIG. 34 is an elevation view of the right side of the cabinet panel of FIG. 30, the left side of the cabinet panel being identical to the right side;

FIG. 35 is a plan view of the top side of the cabinet panel of FIG. 30, the bottom side of the cabinet panel being identical to the top side;

FIG. 36 is an enlarged partial view of a portion of the top side of the cabinet panel of FIG. 35, wherein corners are slightly rounded;

FIG. 37 is an enlarged partial view of a portion of the top side of the cabinet panel of FIG. 35, wherein corners are slightly chamfered; and,

FIG. 38 is an elevation view of the rear of the cabinet panel of FIG. 30.

The aspects shown using combination dashed and dotted lines in FIG. 1 and FIG. 20 are environment only and do not form part of the design.

The aspects shown using just dashed lines in the Figures do not form part of the design.

The broken away symbols in the drawings indicate the appearance of any portion of the article between the break lines forms no part of the claimed design.

The perspective views, FIGS. 3, 4, 5, 12, 13, 14, 22, 23, 24, 31, 32, and 33 are to be understood to be shown in various widths since these are viewed from different perspectives with different angles and elevations, resulting in respective width distortions.

Fig. 1

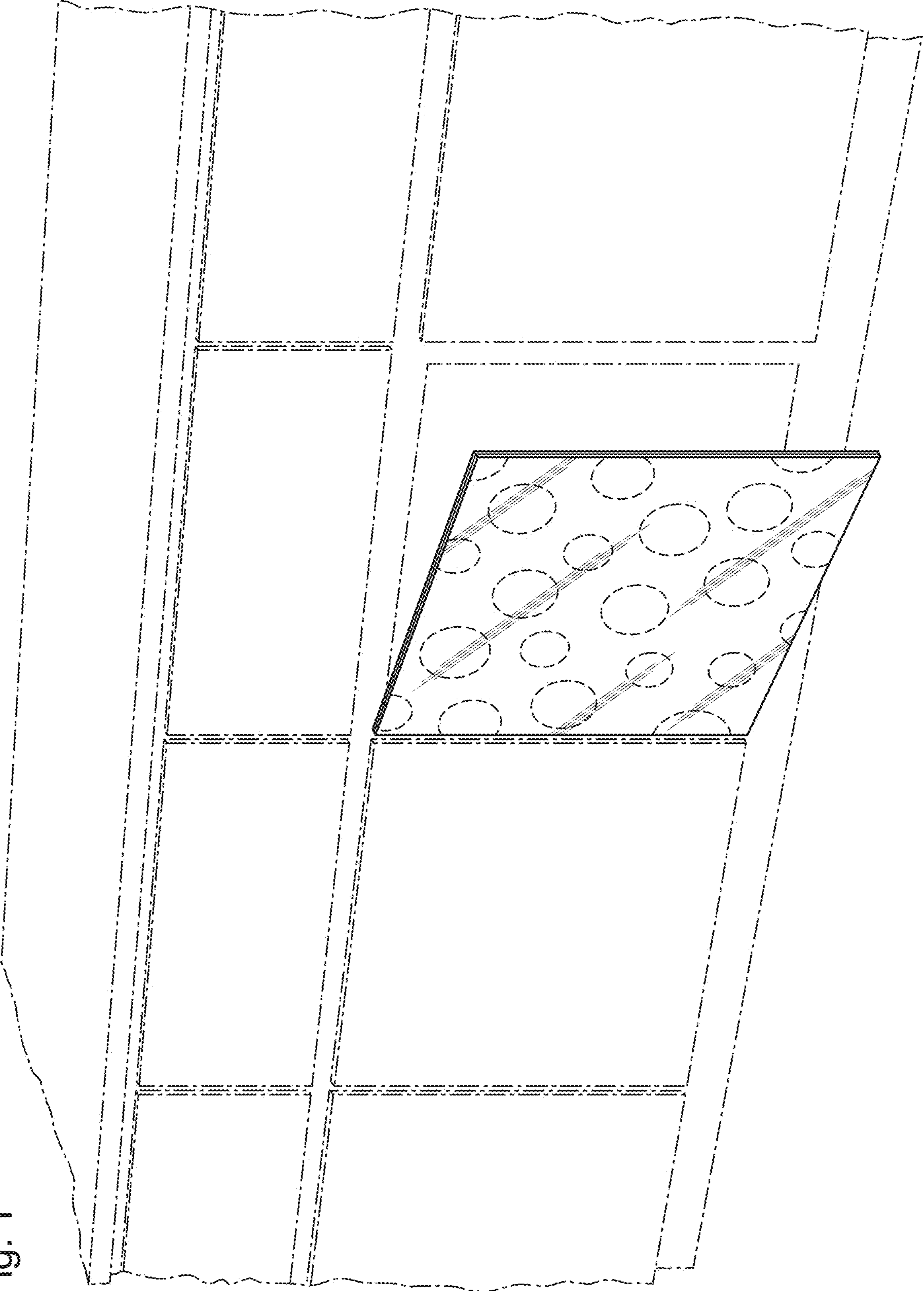

Fig. 2

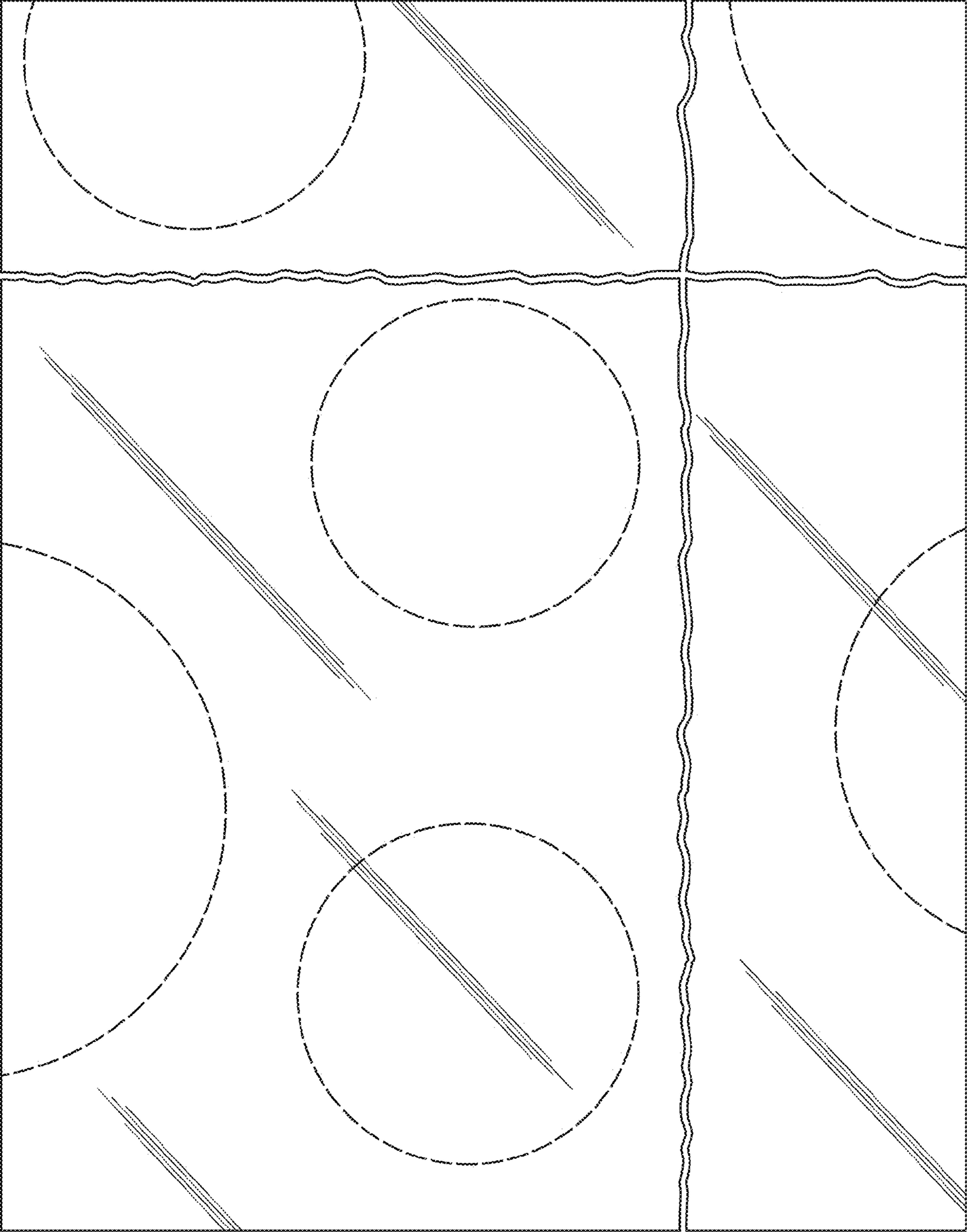

Fig. 3

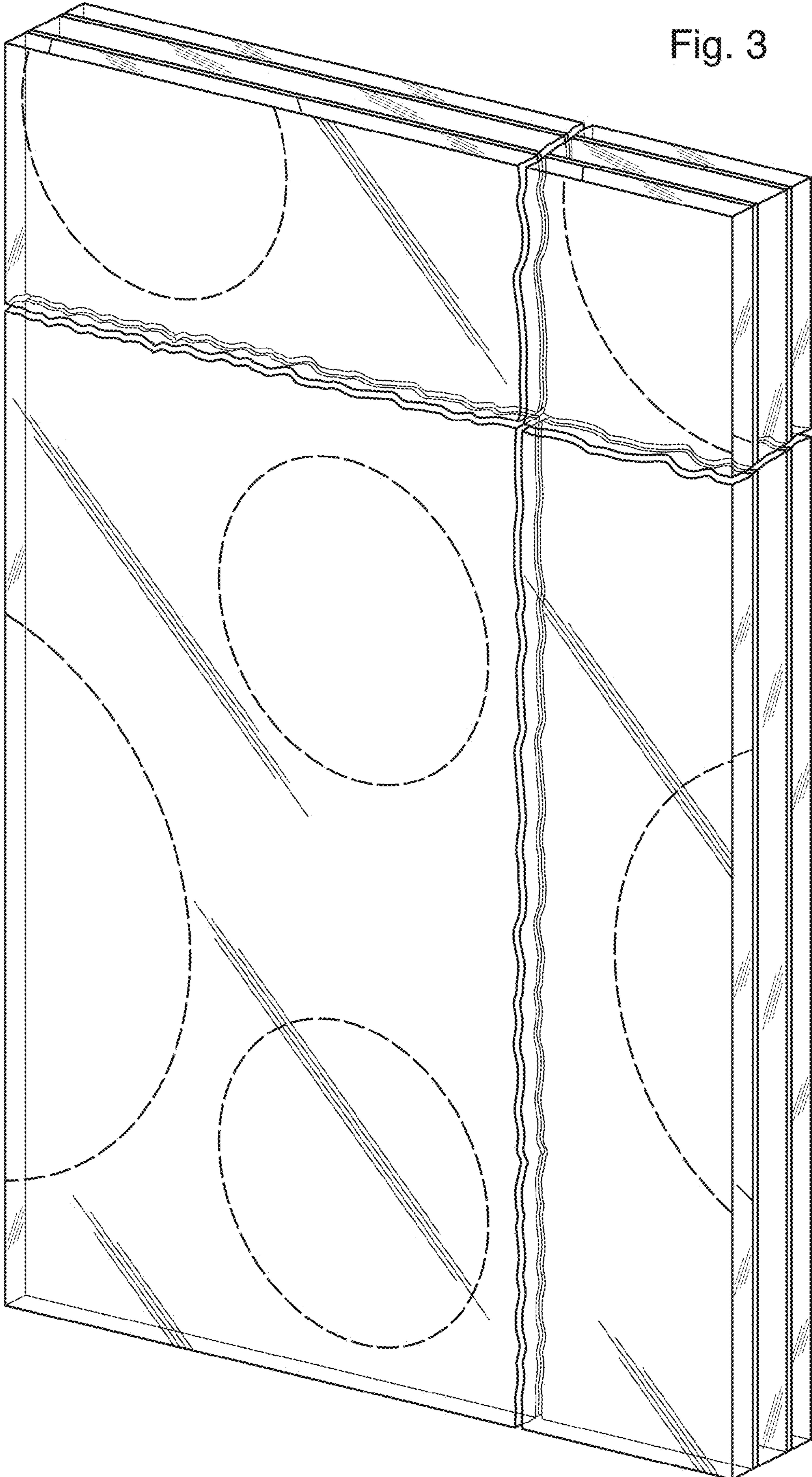

Fig. 4

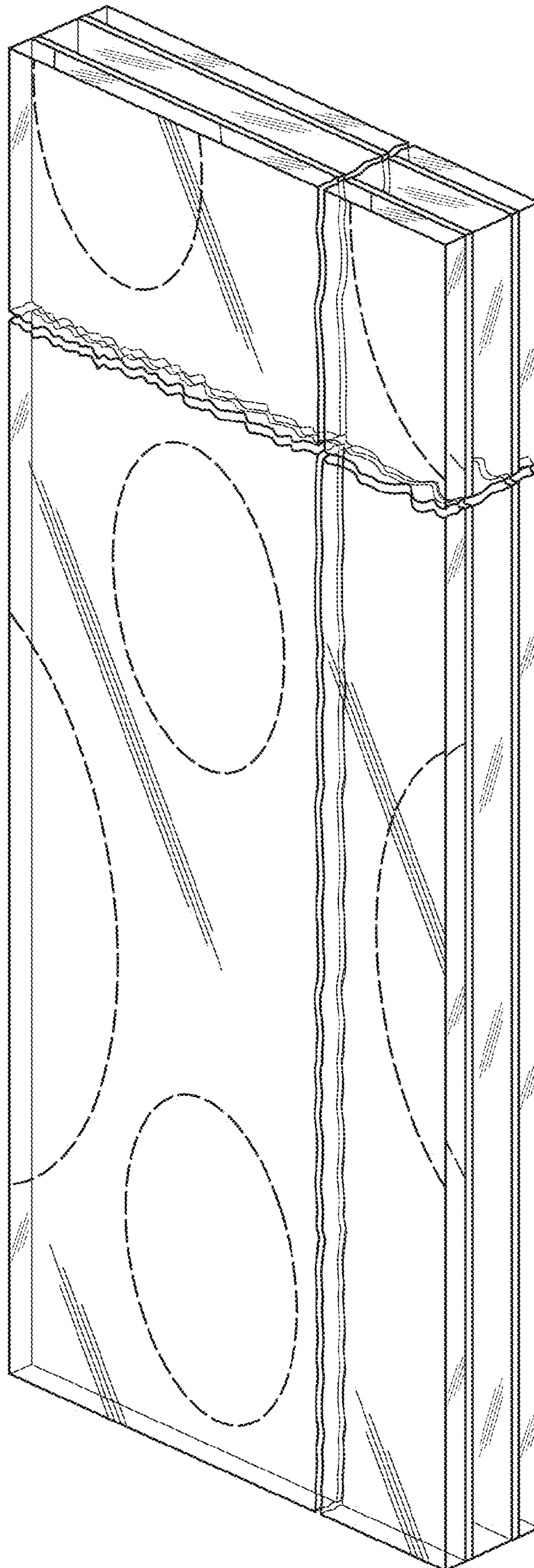

Fig. 5



Fig. 6

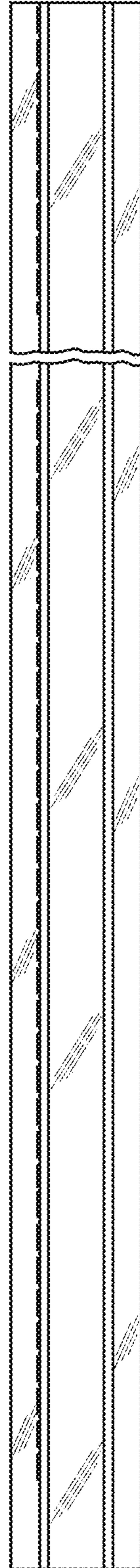

Fig. 8

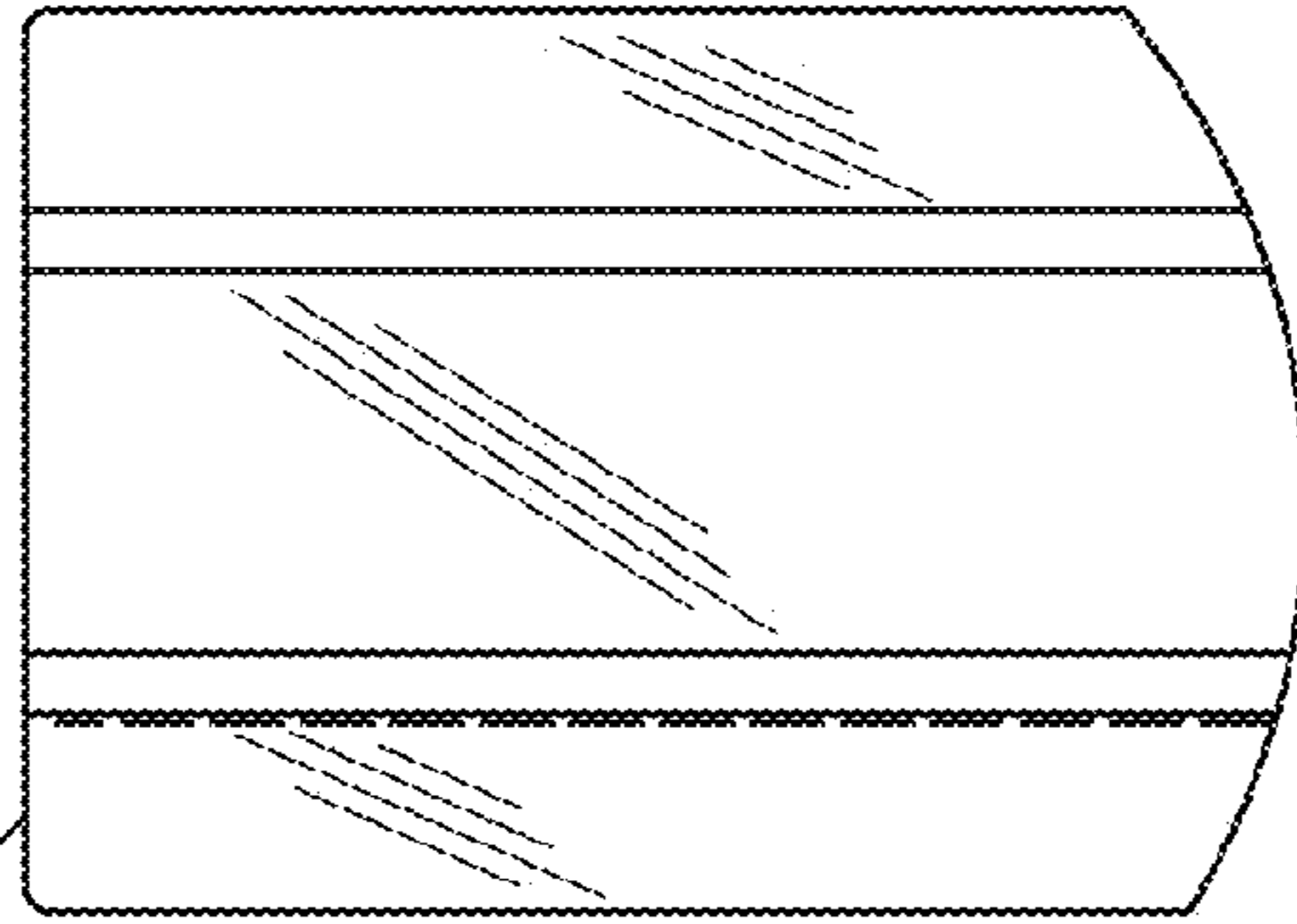

Fig. 7

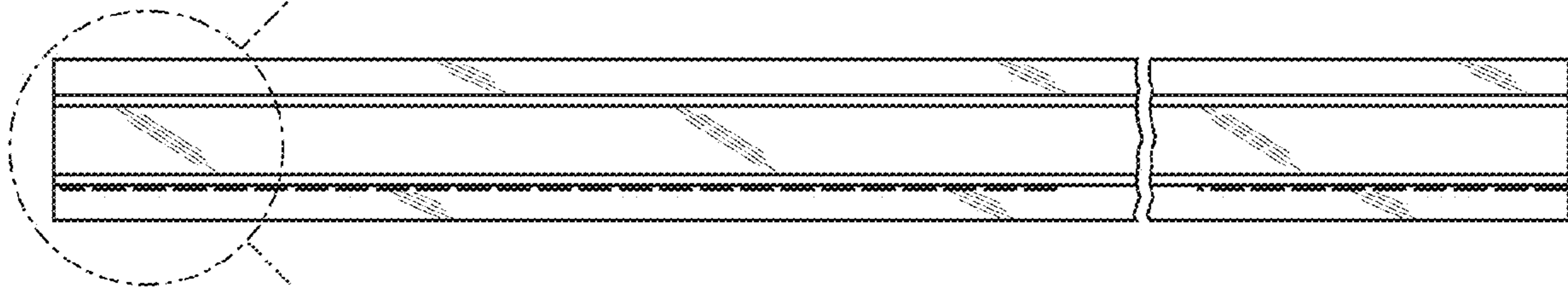

Fig. 9

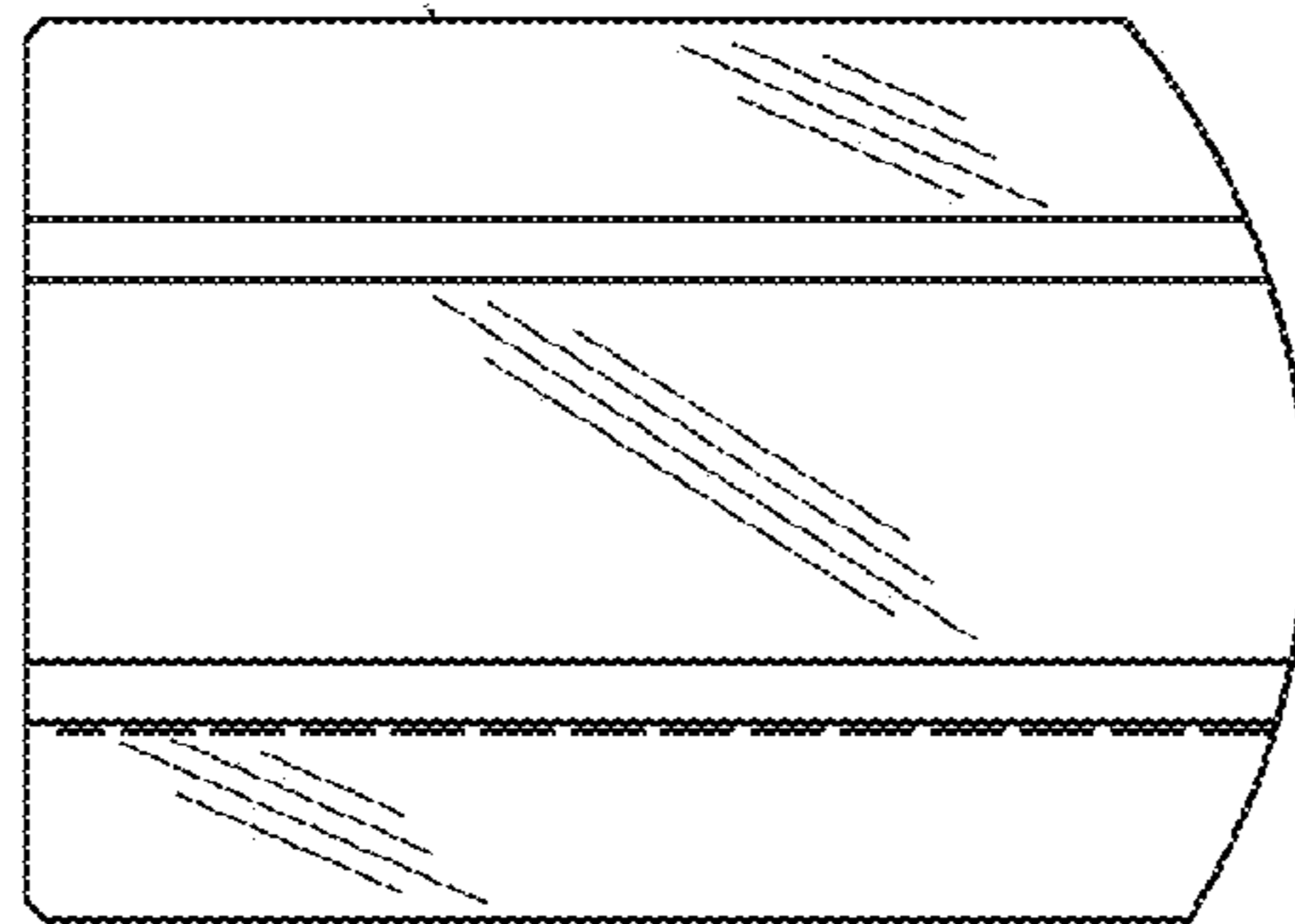

Fig. 10

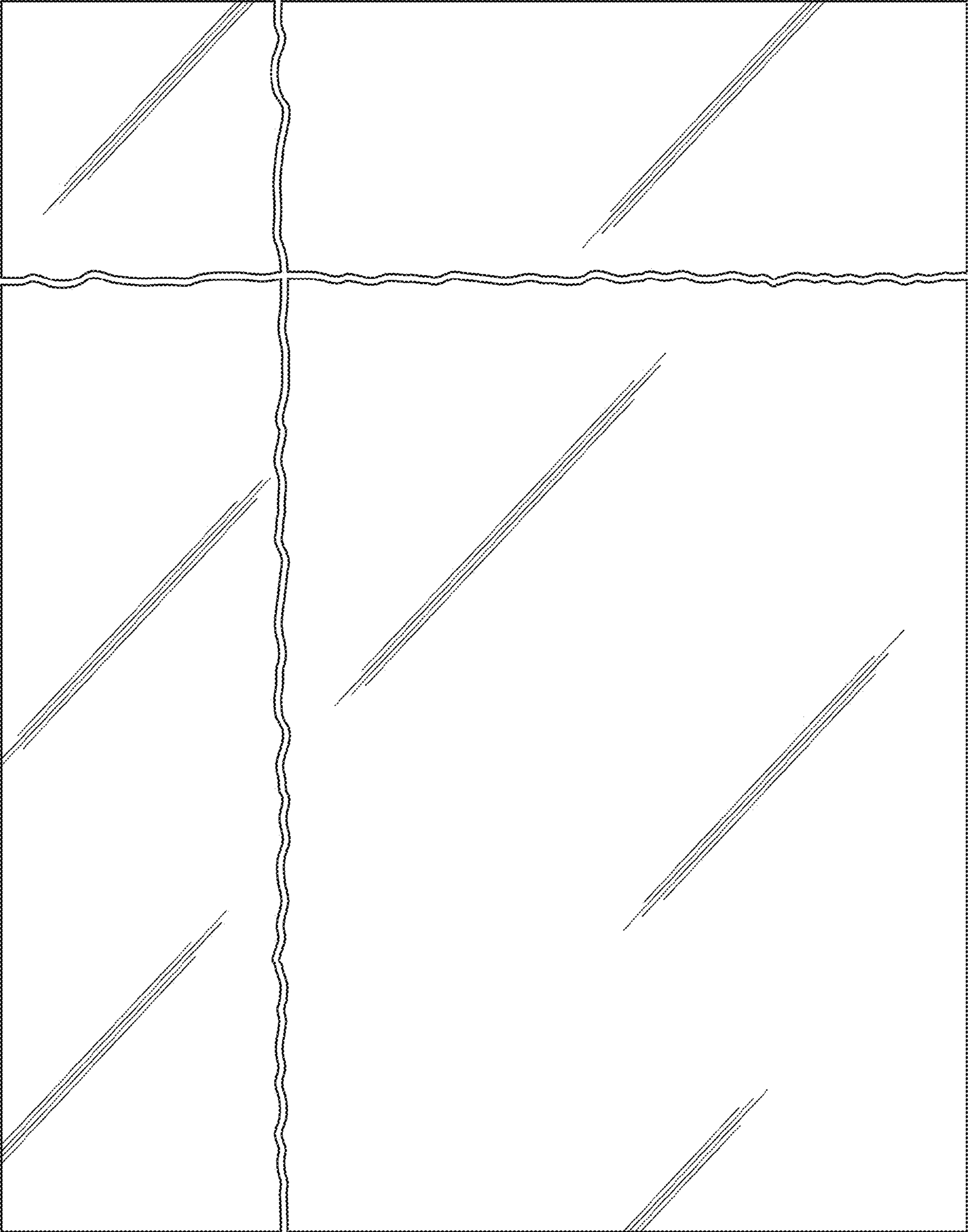

Fig. 11

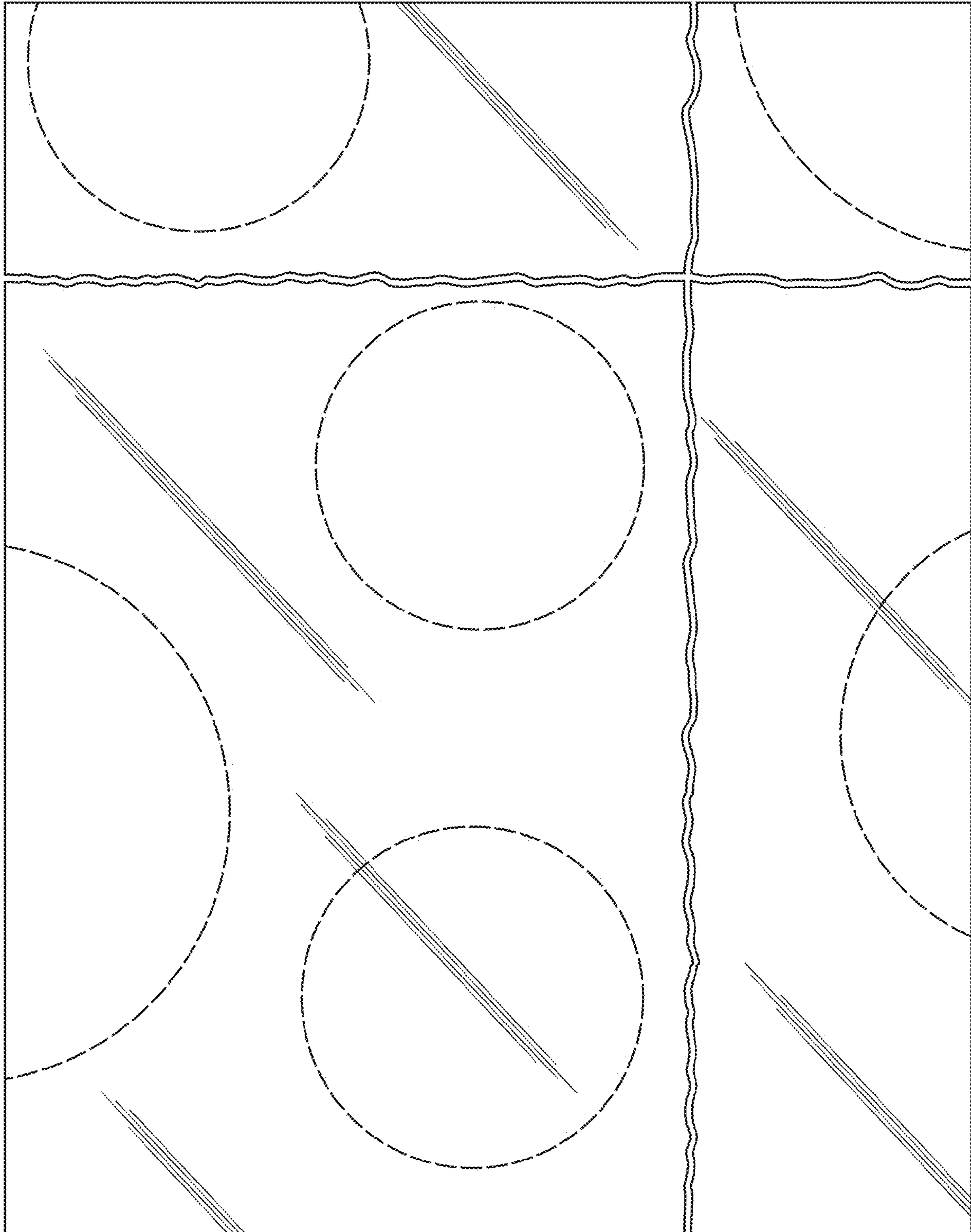
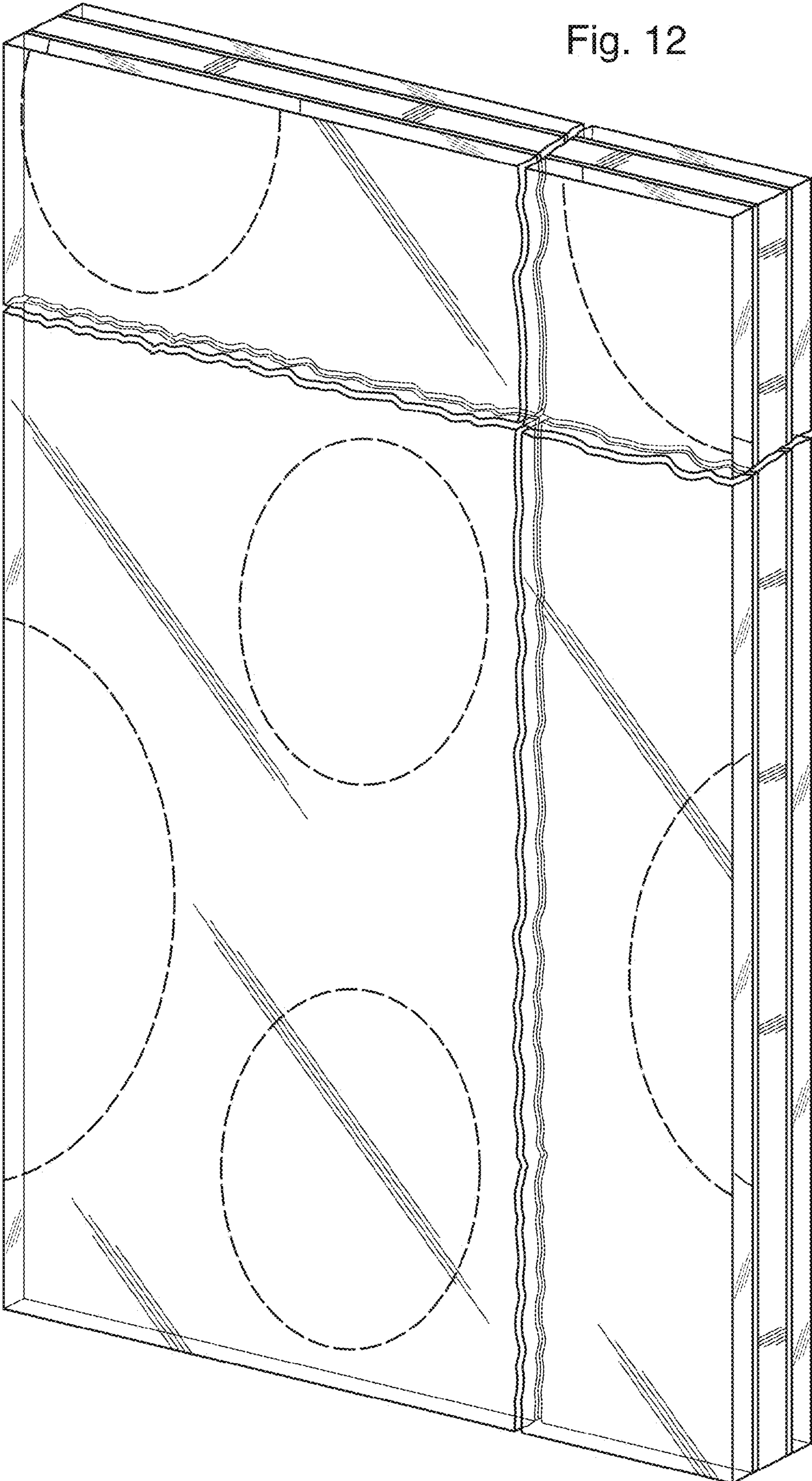

Fig. 12



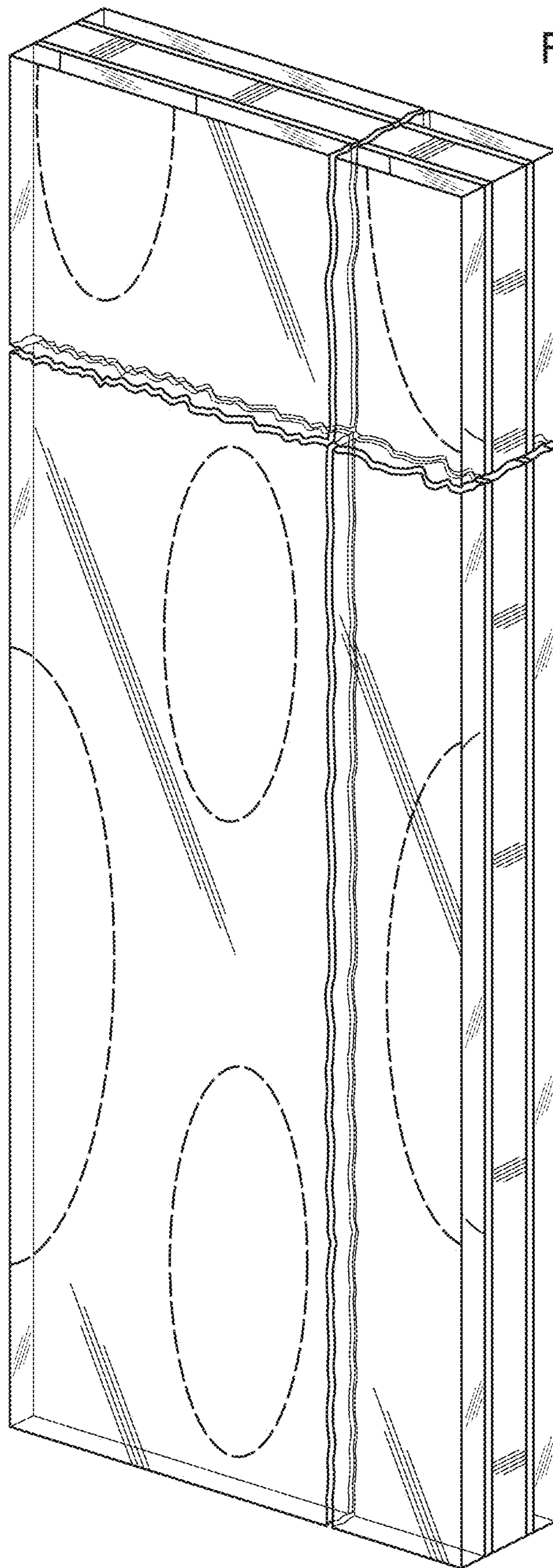

Fig. 13

Fig. 14

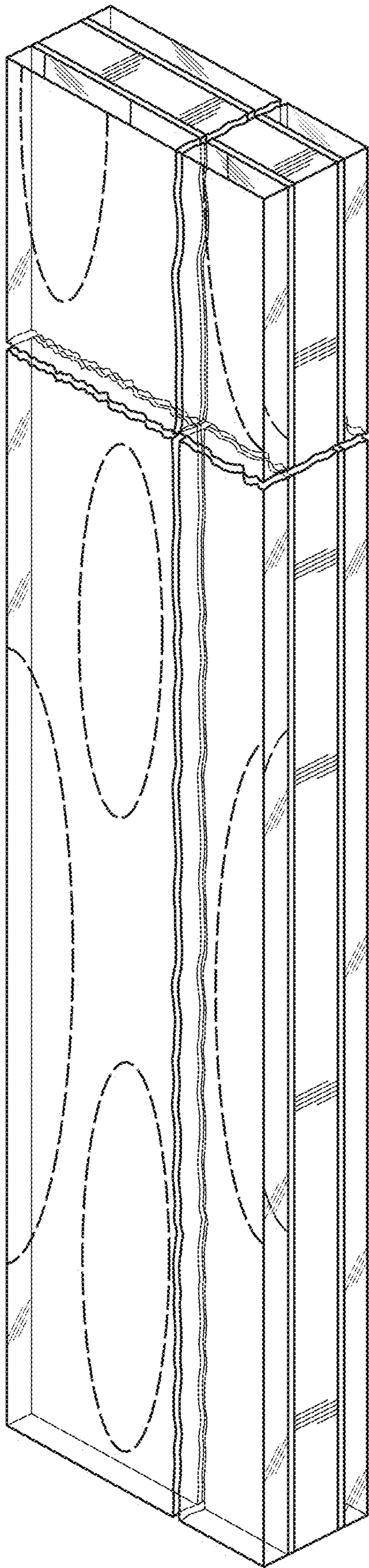

Fig. 15

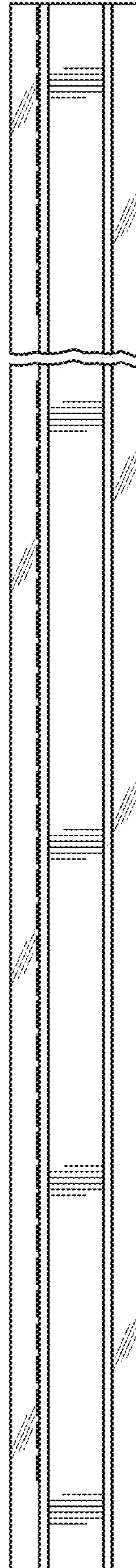

Fig. 17

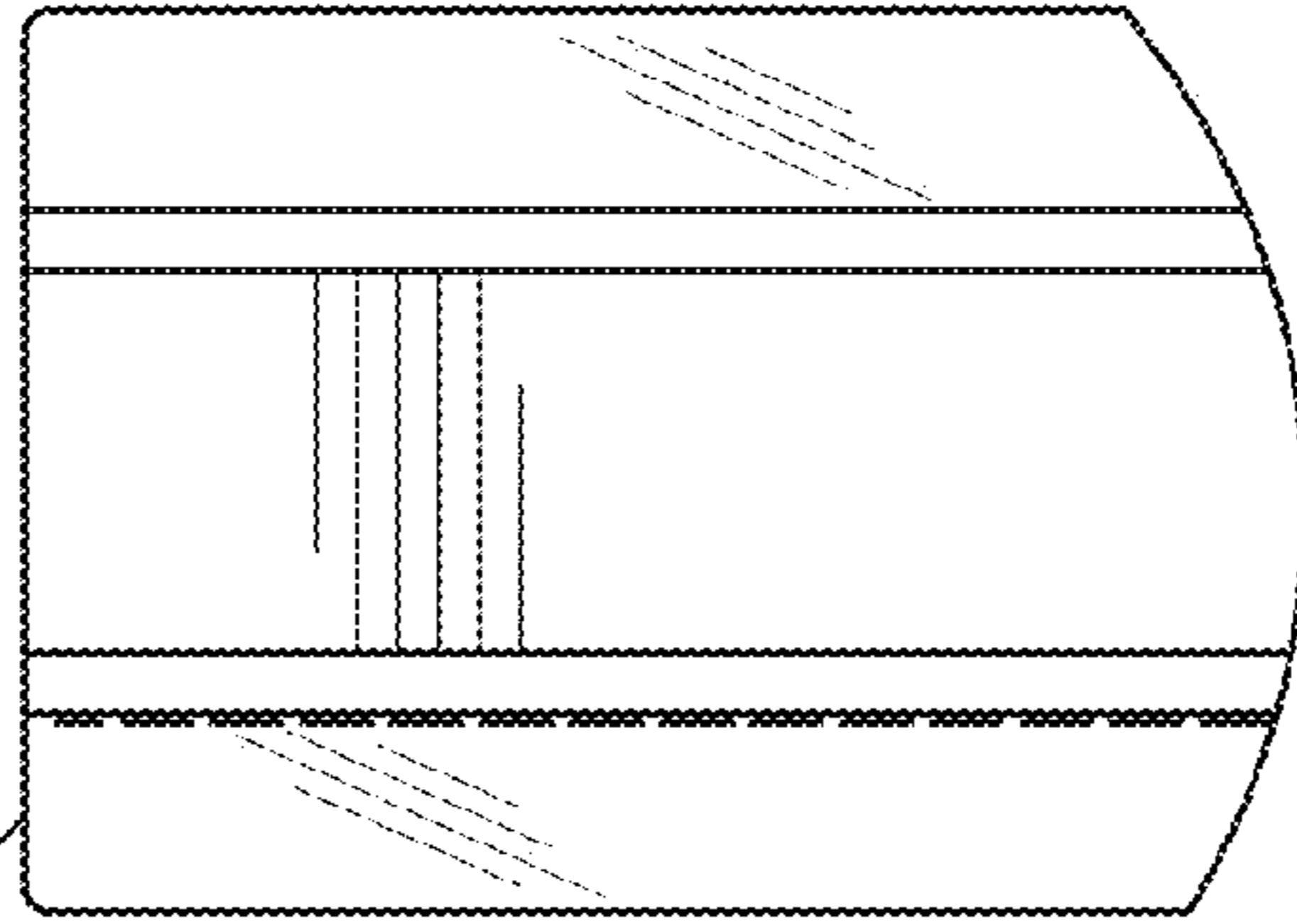

Fig. 16

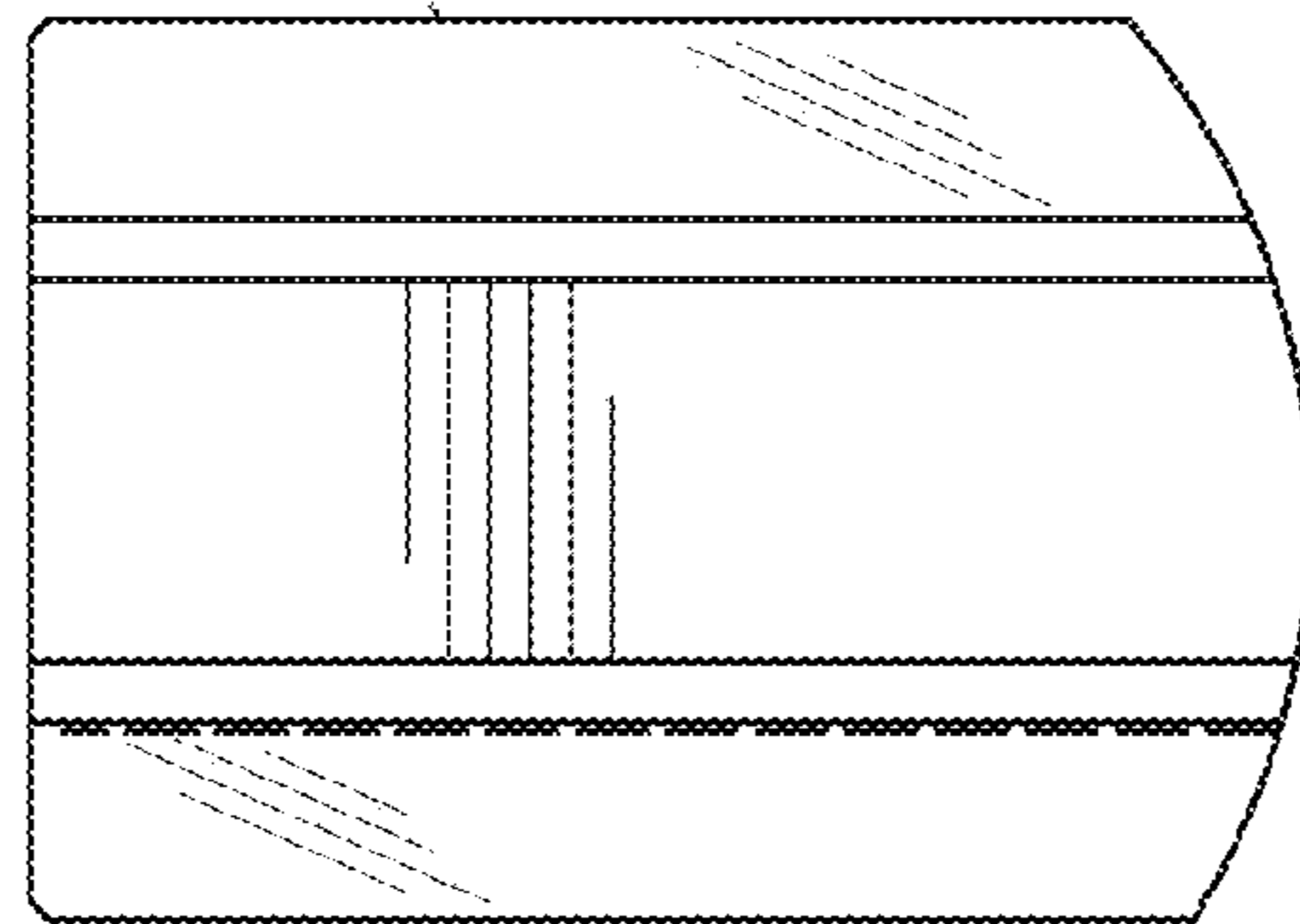
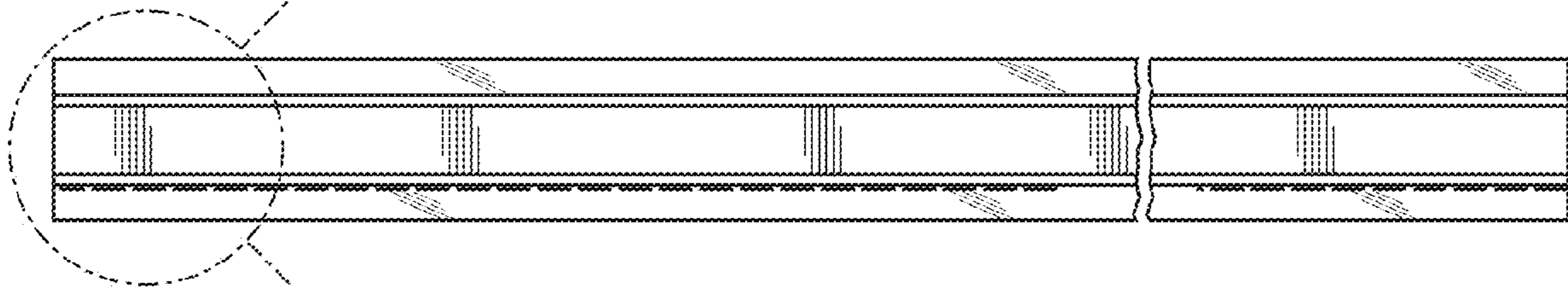

Fig. 18

Fig. 19

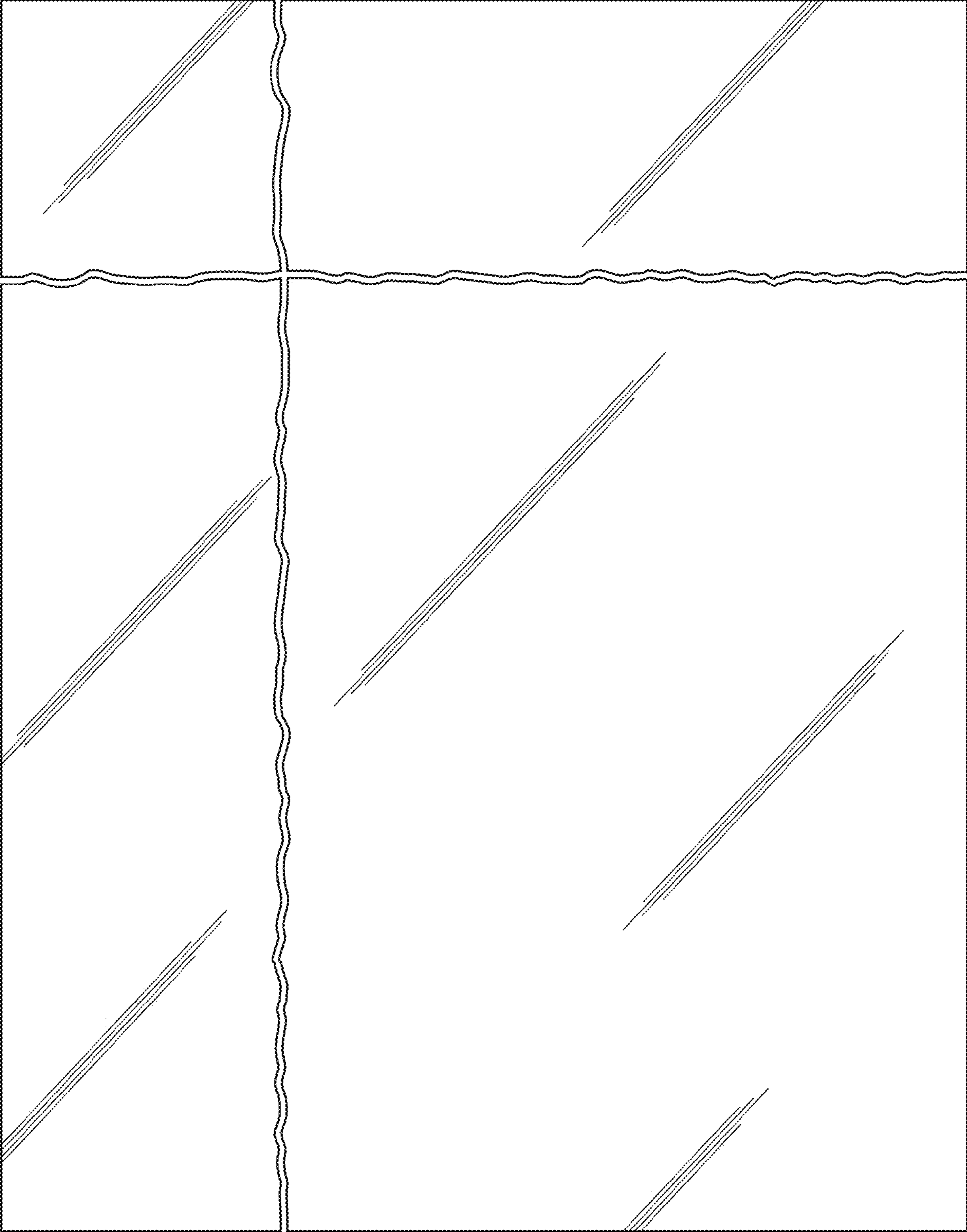

Fig. 20

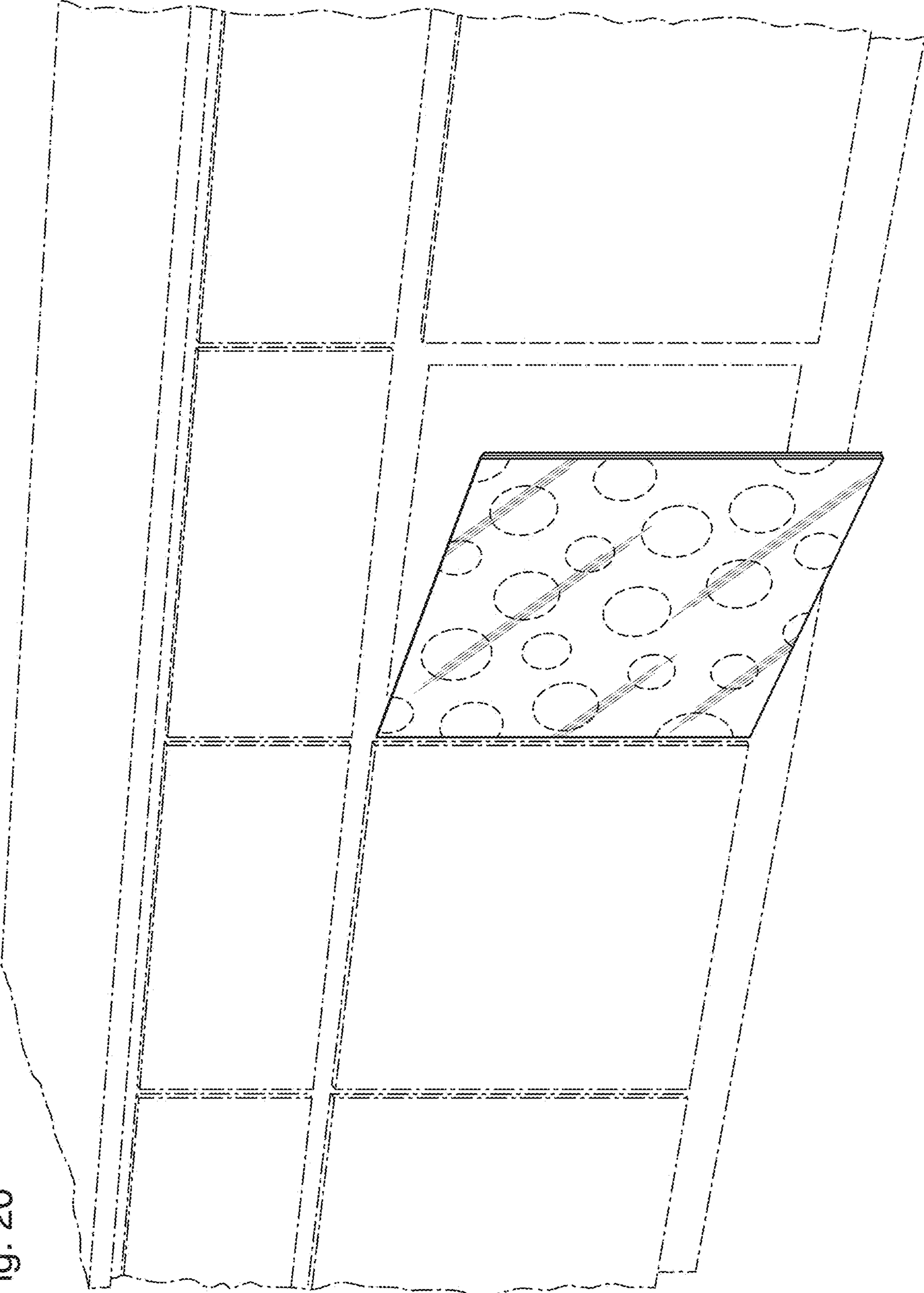

Fig. 21

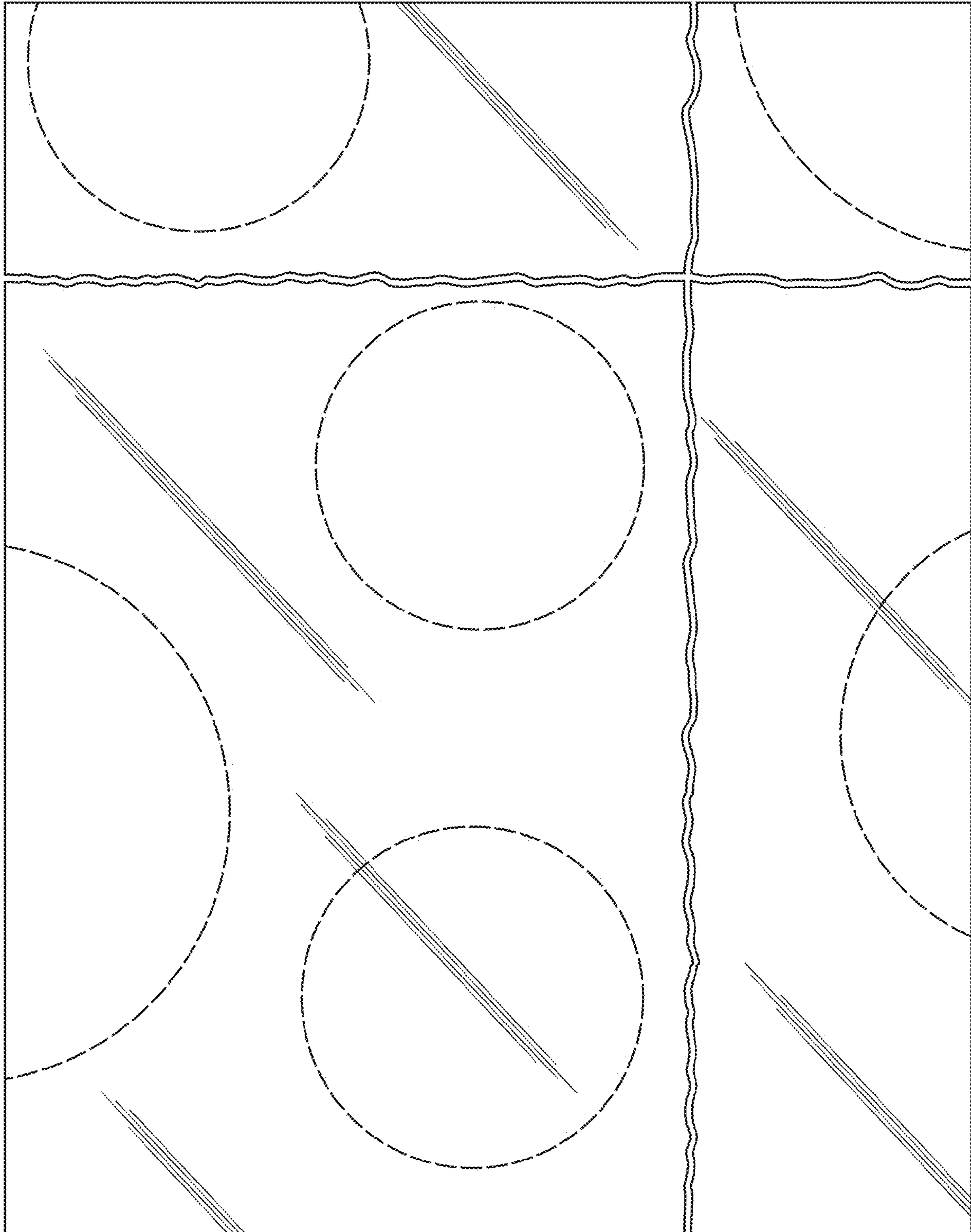

Fig. 22

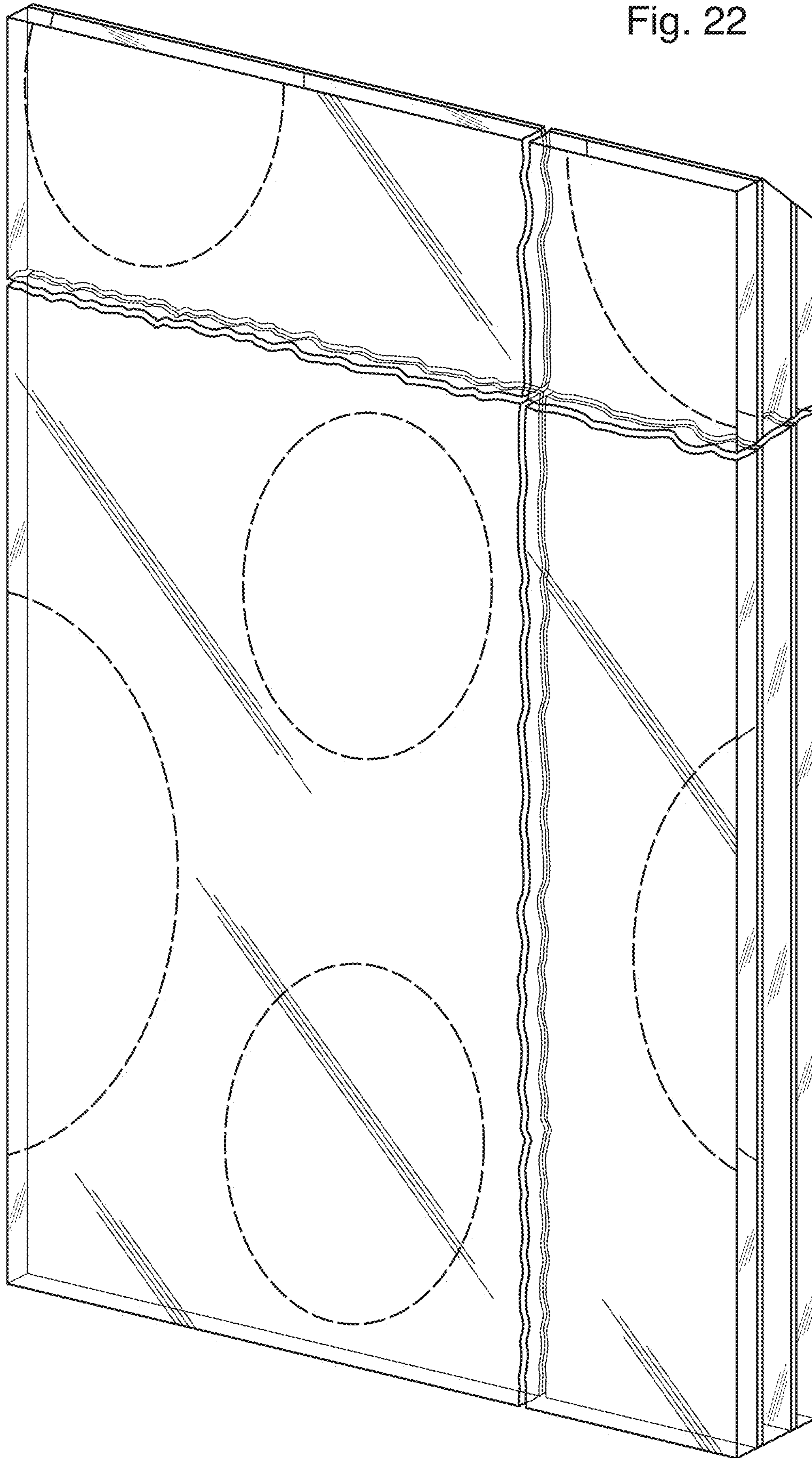

Fig. 23

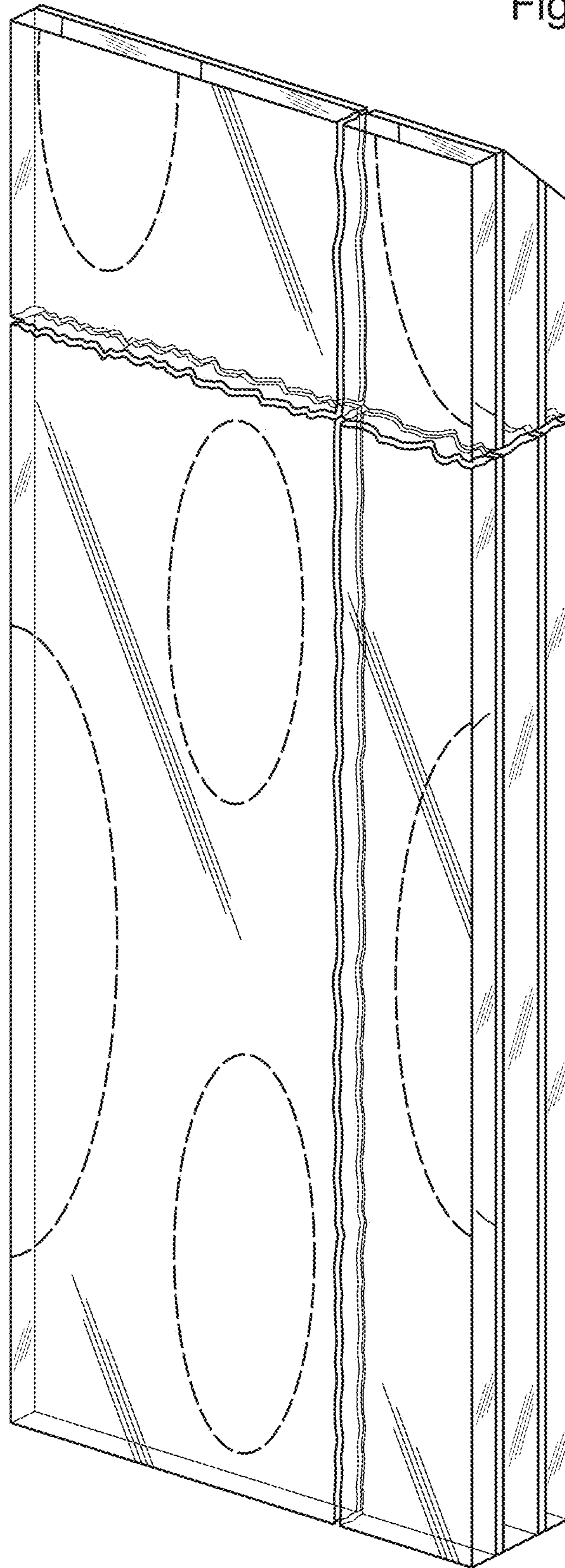

Fig. 24

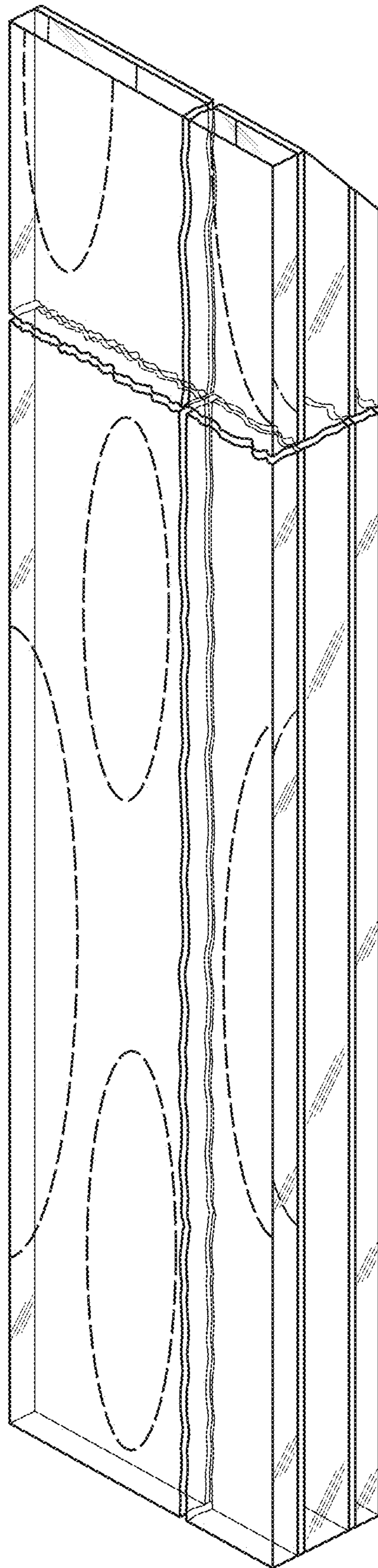

Fig. 25

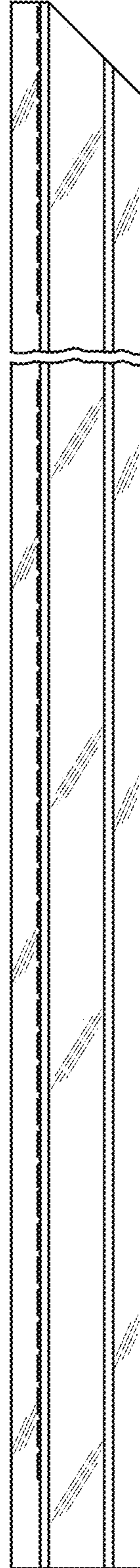

Fig. 27

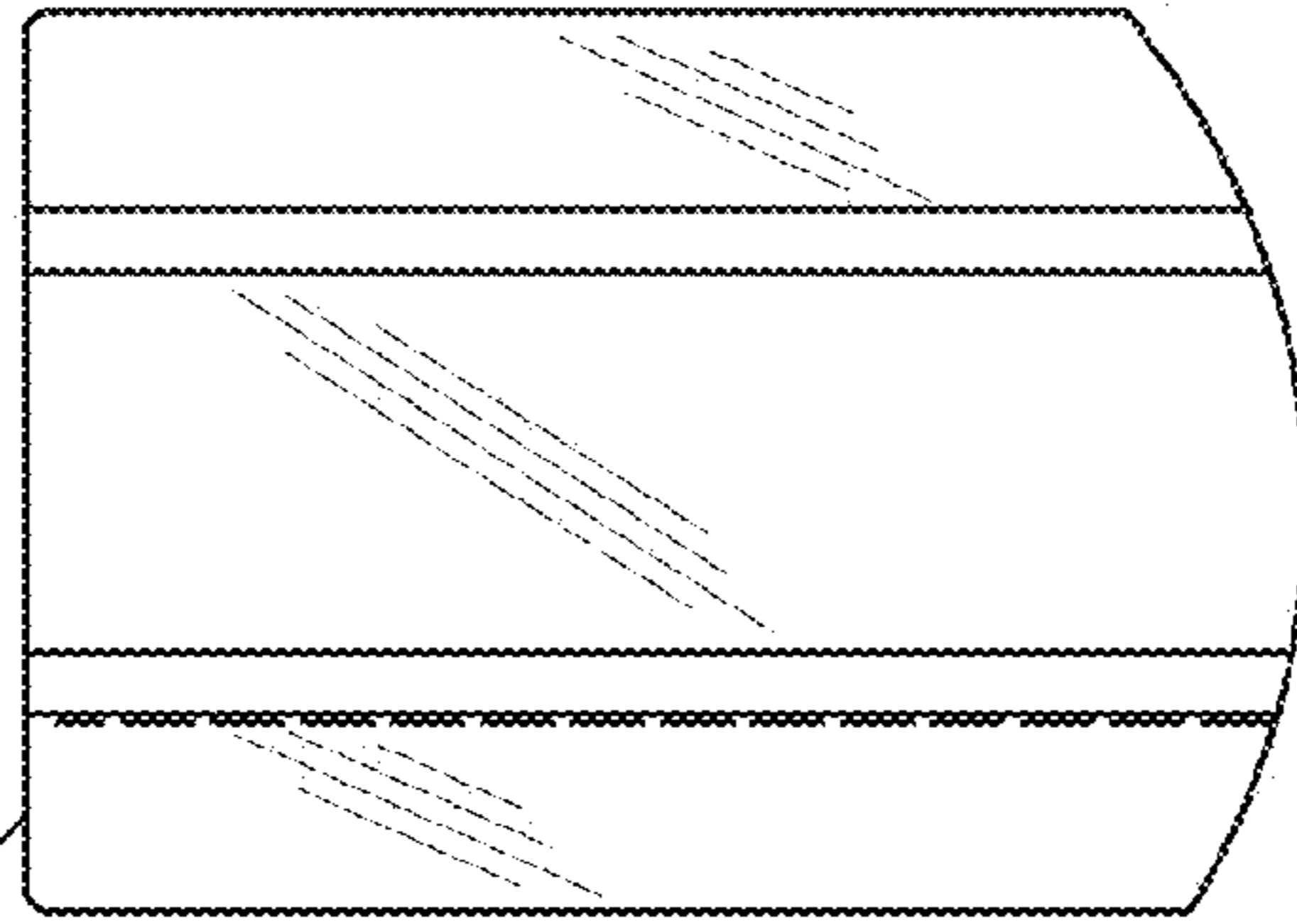

Fig. 26

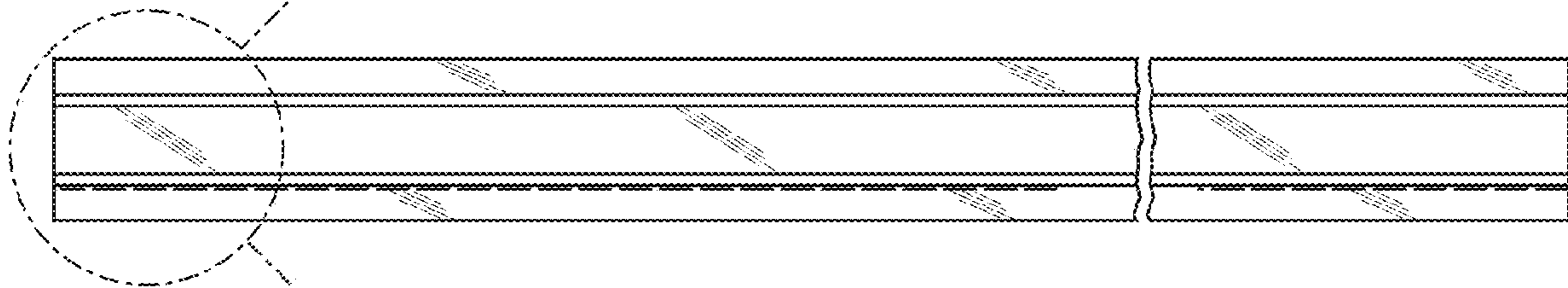

Fig. 28

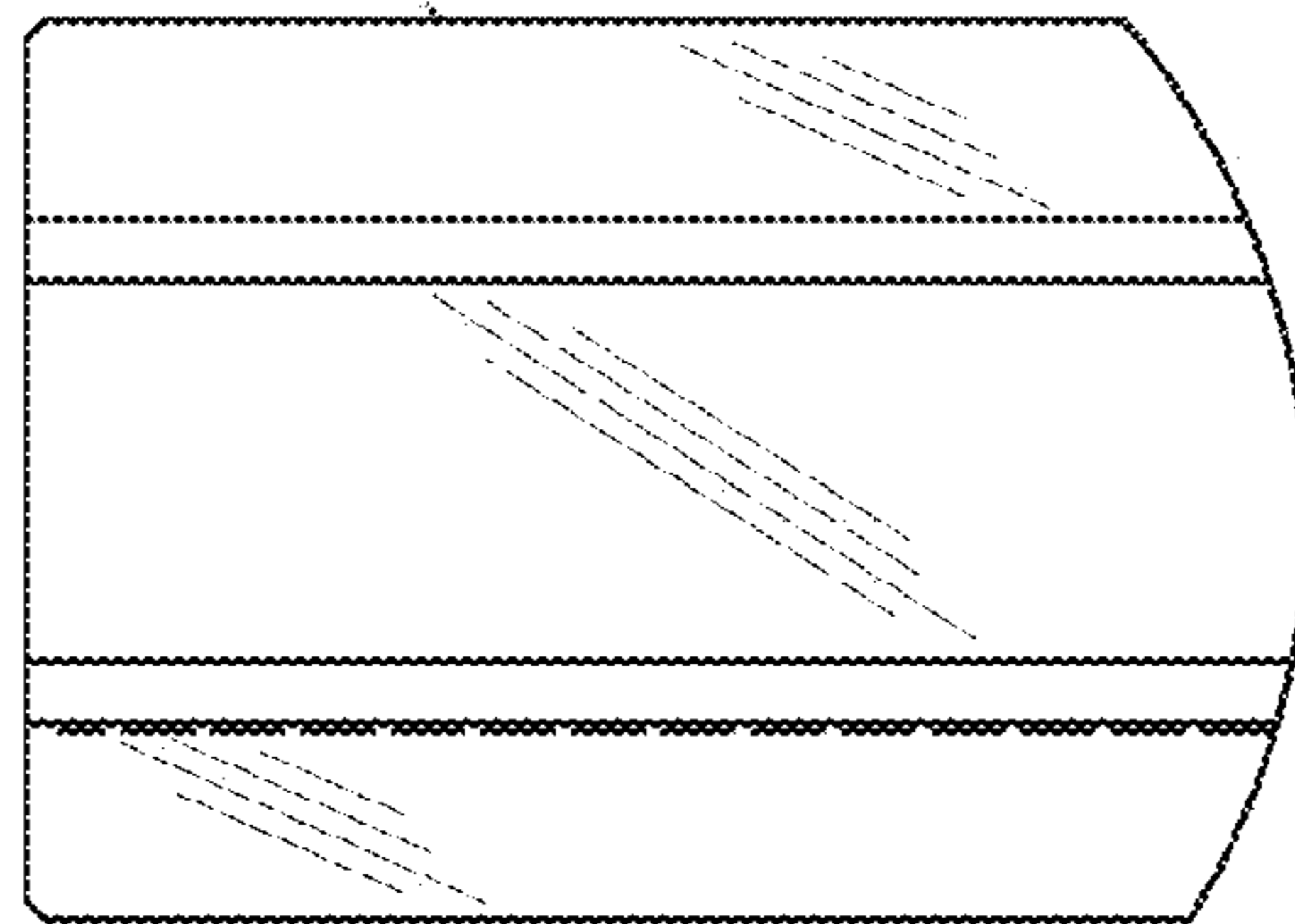

Fig. 29

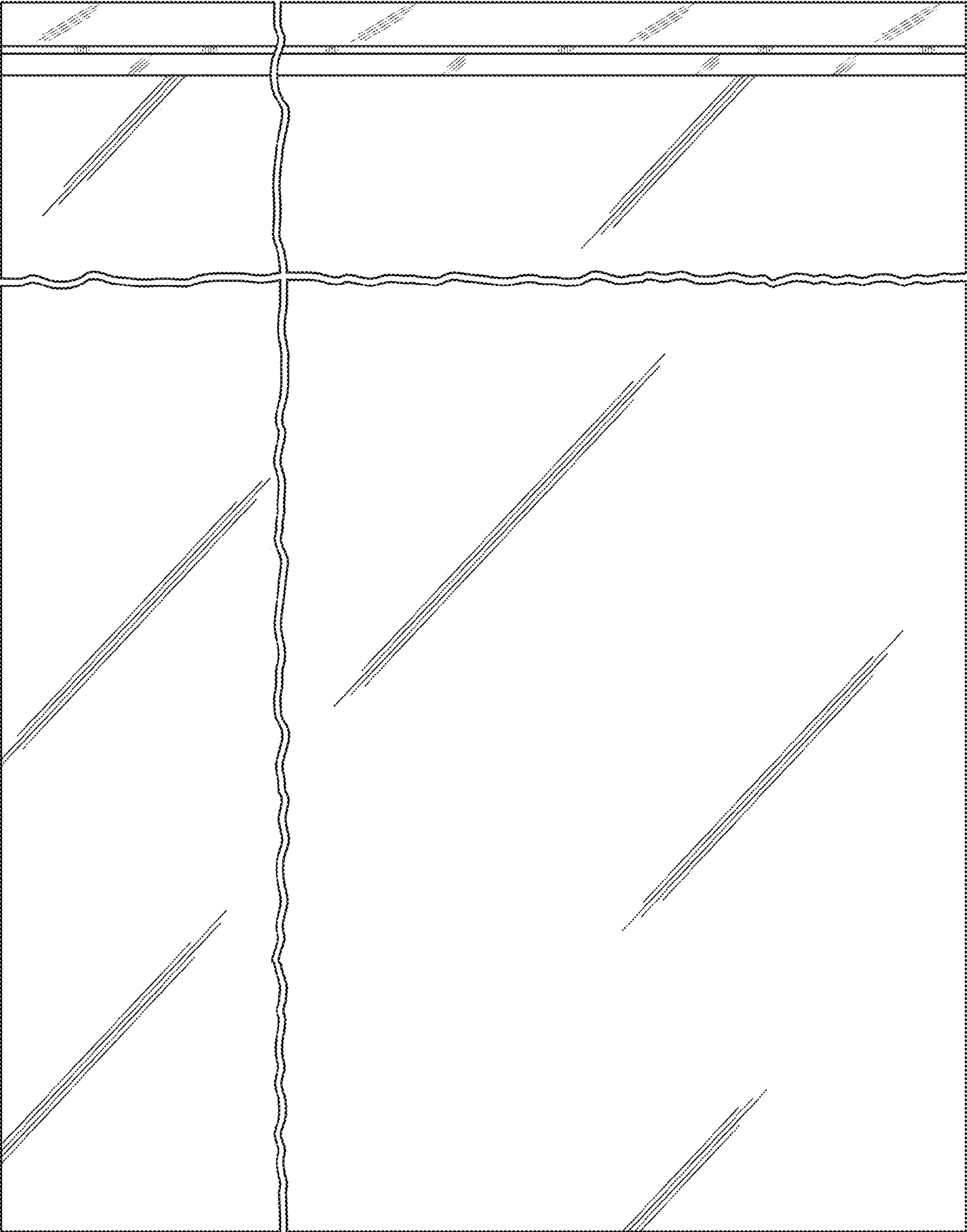

Fig. 30

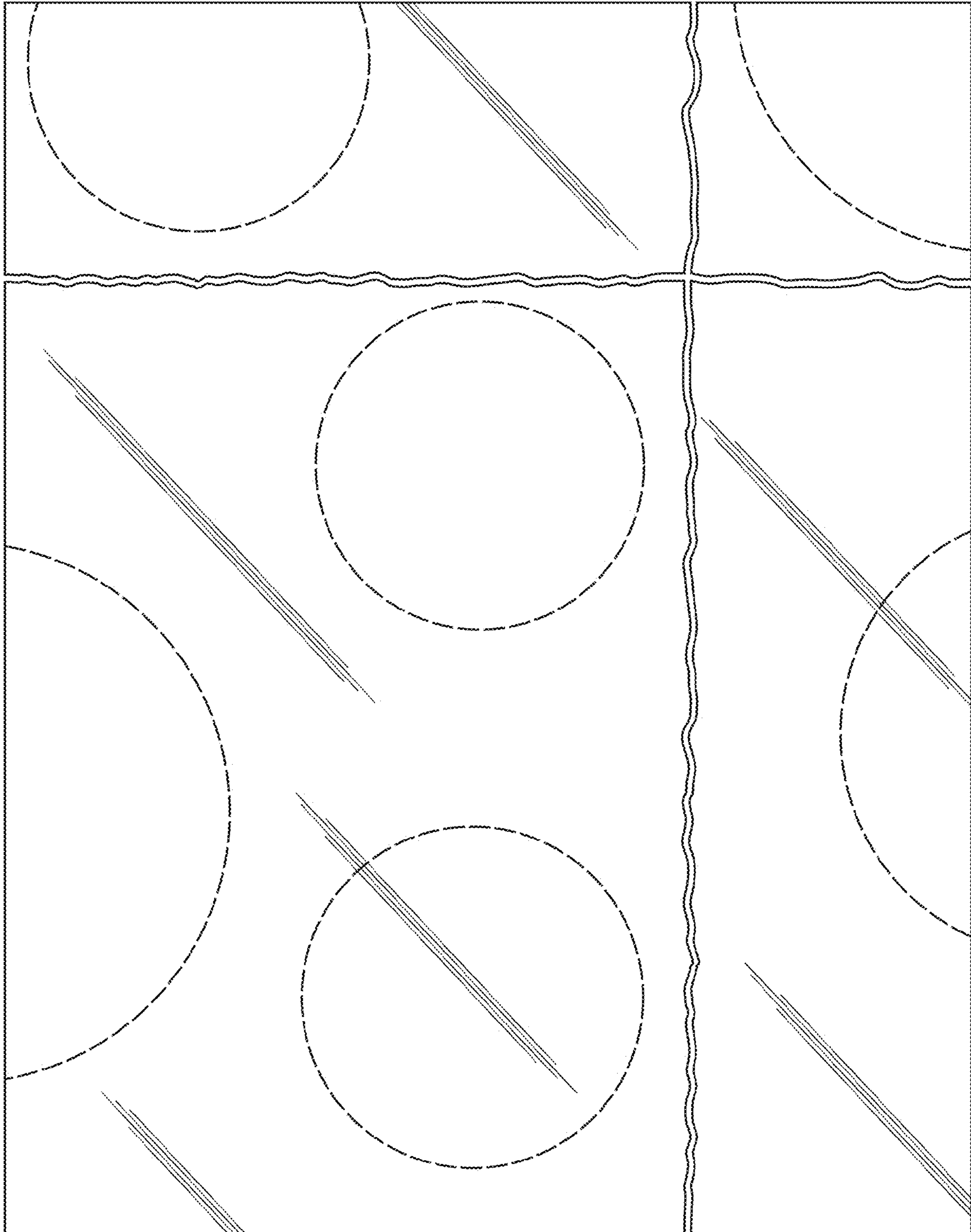

Fig. 31

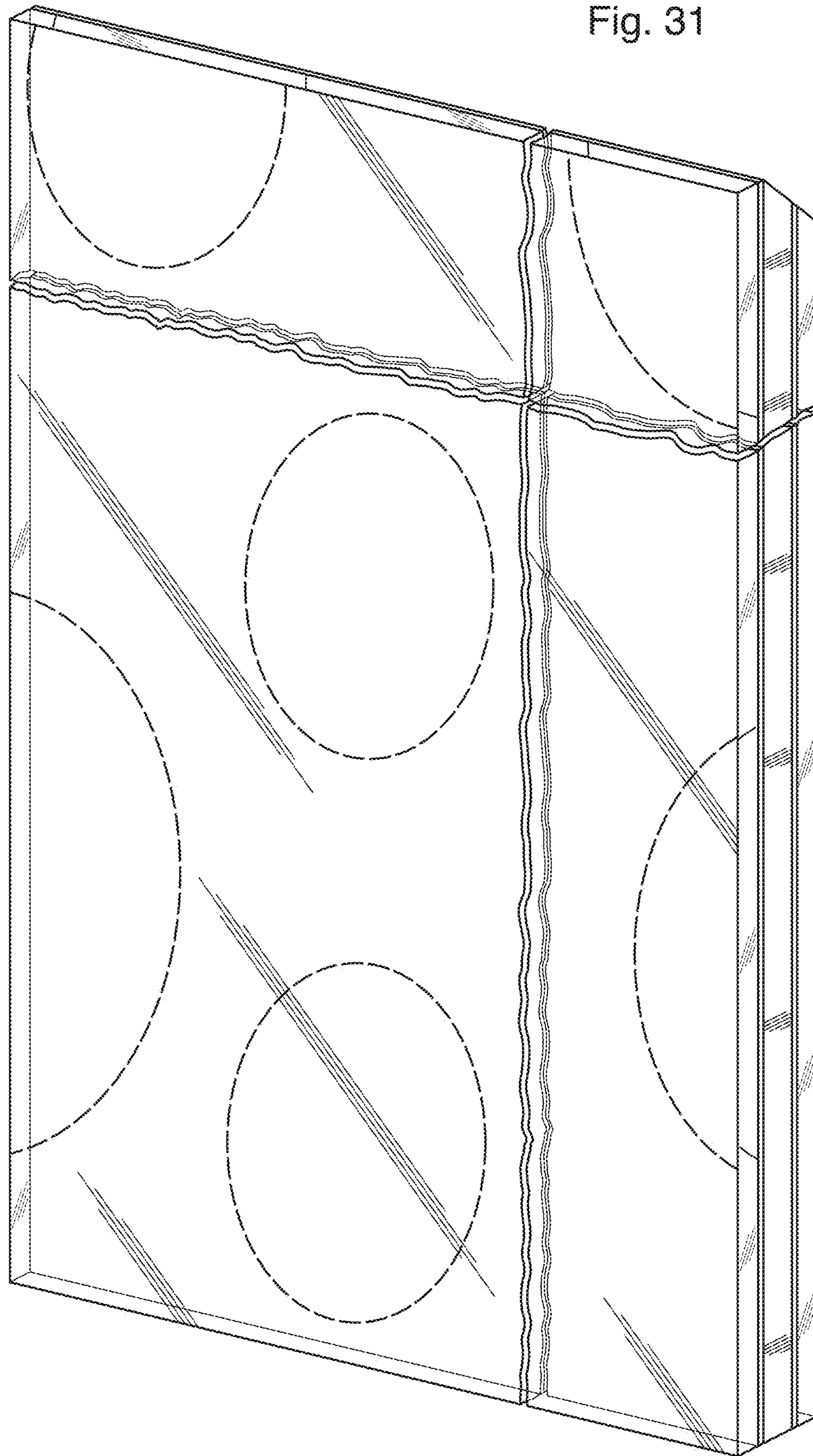

Fig. 32

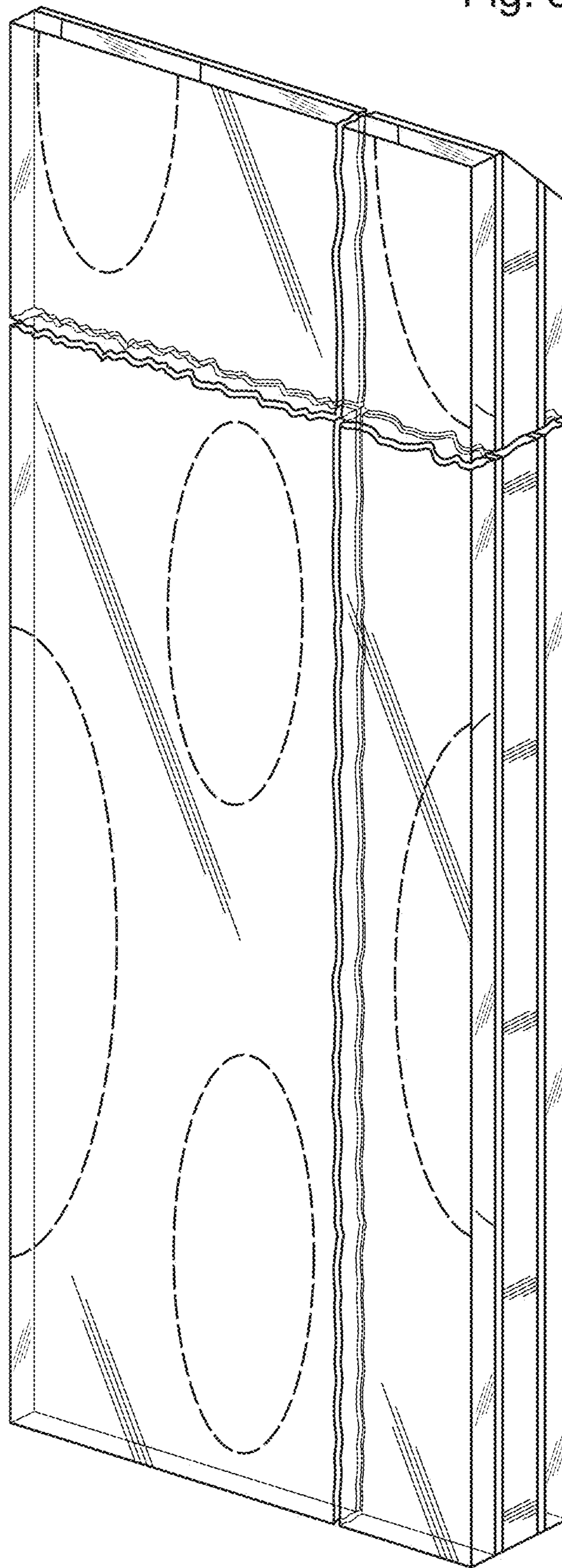

Fig. 33

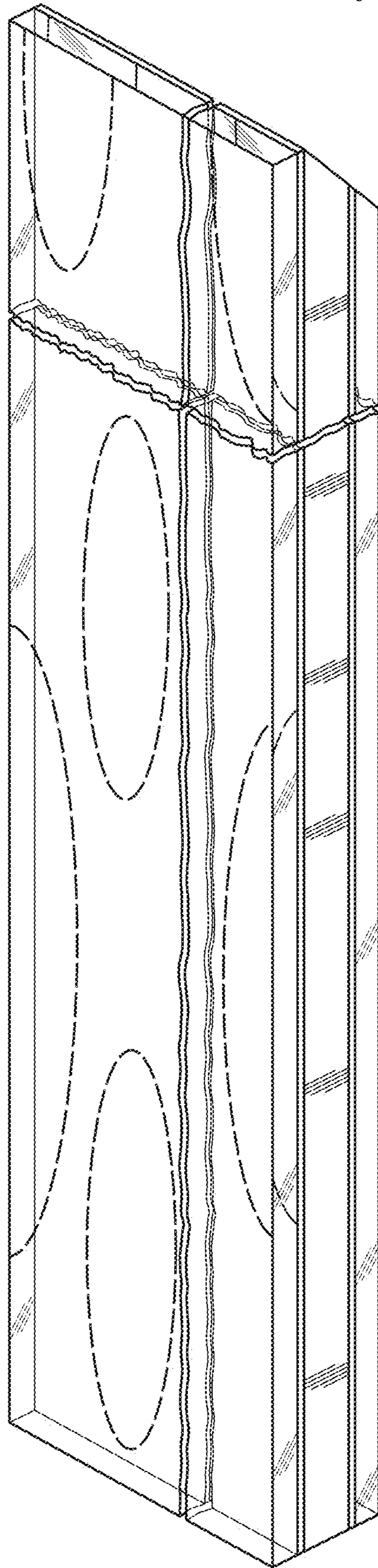

Fig. 34

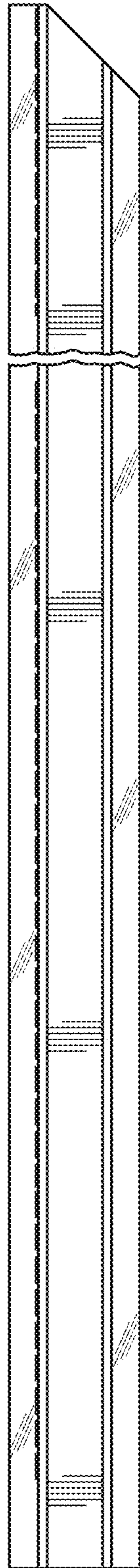

Fig. 36

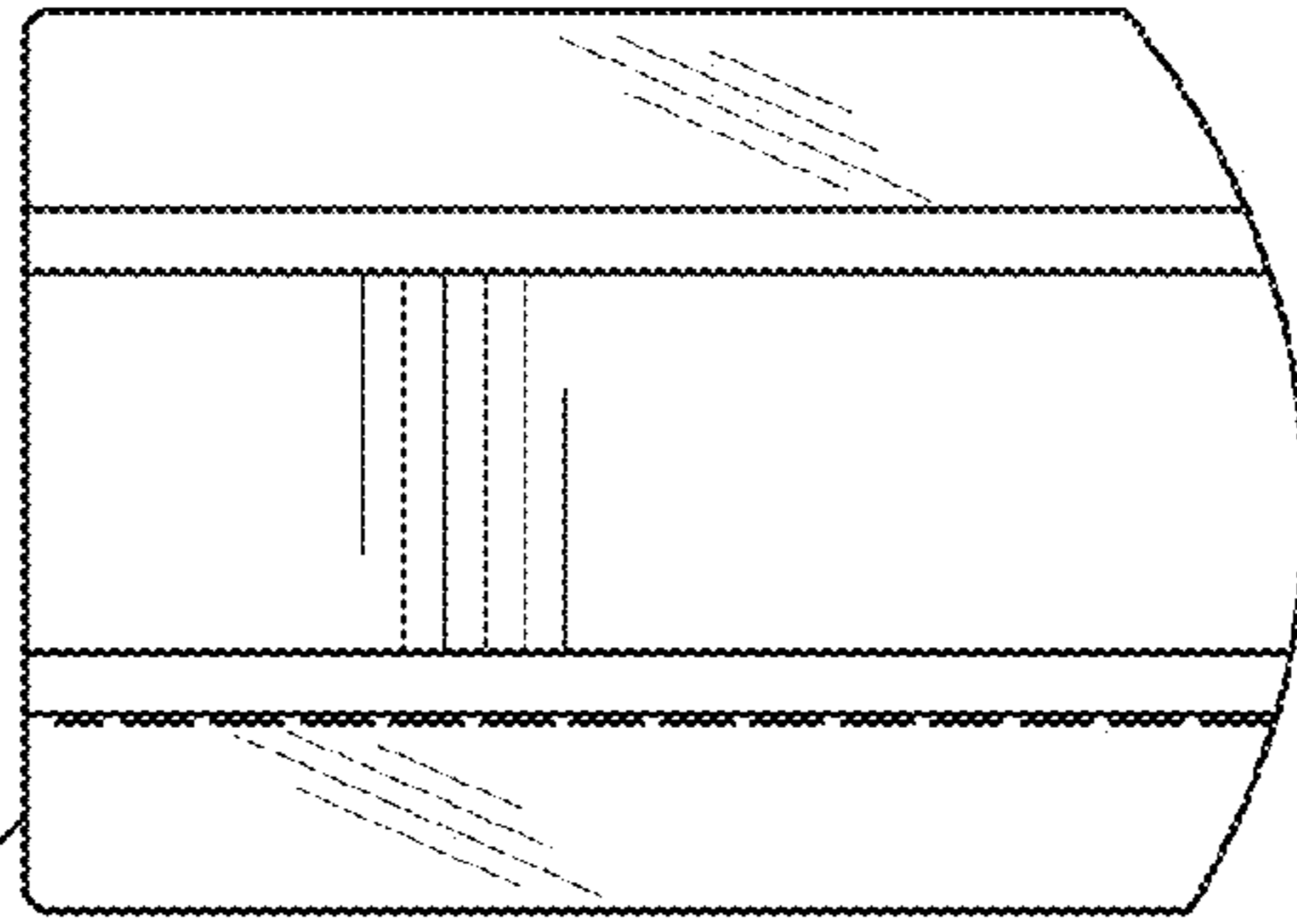

Fig. 35

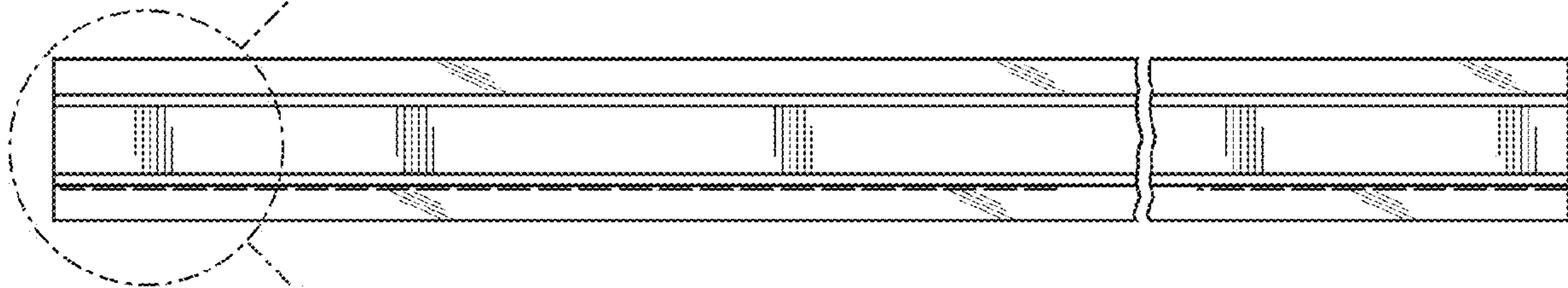

Fig. 37

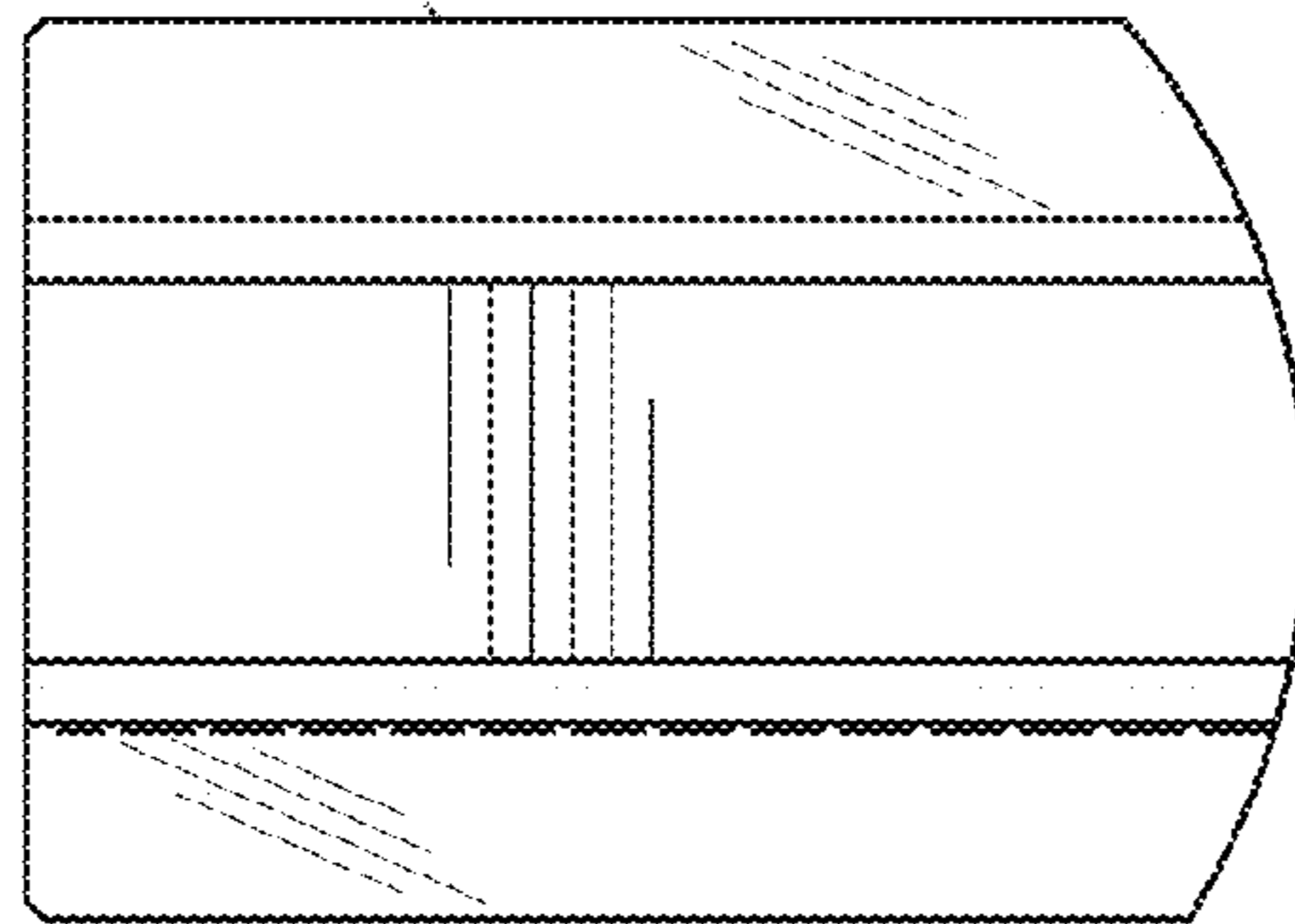

Fig. 38

