



US00D956412S

(12) **United States Design Patent** (10) **Patent No.:** **US D956,412 S**
Huang (45) **Date of Patent:** **** Jul. 5, 2022**

(54) **STORAGE BAG**

(71) Applicant: **Yunjin Huang**, Guangdong (CN)

(72) Inventor: **Yunjin Huang**, Guangdong (CN)

(**) Term: **15 Years**

(21) Appl. No.: **29/748,262**

(22) Filed: **Aug. 27, 2020**

(51) **LOC (13) Cl.** **03-01**

(52) **U.S. Cl.**
USPC **D3/226**

(58) **Field of Classification Search**

USPC D3/274, 276, 285, 289, 290, 306, 313,
D3/203.1, 203.6, 205, 226, 230, 232, 242,
D3/245, 246, 267, 268, 273, 275, 283,
D3/284, 286, 287, 288, 294, 295, 301,
D3/303, 900, 901, 903, 201, 218, 240,
D3/270, 271.9, 221, 215, 222, 228, 251,
D3/296; D7/607, 609; D27/172, 183,
D27/186, 190, 191; D28/73, 76, 99;
D9/420

CPC A45C 1/02; A45C 3/00; A45C 3/02; A45C
3/04; A45C 3/06; A45C 3/004; A45C
5/00; A45C 5/03; A45C 5/04; A45C 5/08;
B42D 5/005; B65D 81/02; B65D 81/022;
B65D 83/02; B65D 85/00; B65D 85/08;
B65D 85/10; B65D 85/12; B65D 85/14

See application file for complete search history.

(56) **References Cited**

U.S. PATENT DOCUMENTS

D258,731 S * 3/1981 Fleischman D12/409
D283,043 S * 3/1986 Pitts D3/222
D408,136 S * 4/1999 Pesce, Jr. D3/228
D413,722 S * 9/1999 Altenbach D3/212
D495,484 S * 9/2004 Marks D3/215
D550,956 S * 9/2007 Kendrick D3/221
D835,401 S * 12/2018 Greenberg D3/226

D836,340 S * 12/2018 Weiner D3/303
D897,669 S * 10/2020 Grassi D3/228
D899,770 S * 10/2020 Leonard D3/251
D909,054 S * 2/2021 Huang D3/226
D922,063 S * 6/2021 Kirchner D3/218
D930,982 S * 9/2021 Woody D3/299

(Continued)

FOREIGN PATENT DOCUMENTS

CN 304092415 * 4/2017
CN 304680594 * 6/2018

(Continued)

OTHER PUBLICATIONS

Amazon.ca, Site visited Dec. 7, 2021, Nathan Peak Waist Pack, First Available Jan. 21, 2015, <https://www.amazon.ca/Nathan-Peak-Waist-Pack-Black/dp/B00EWJIVX8> (Year: 2015).*

(Continued)

Primary Examiner — Brett Miller
Assistant Examiner — Jessica M Gebhart
(74) *Attorney, Agent, or Firm* — ScienBiziP, P.C.

(57) **CLAIM**

The ornamental design for a storage bag, as shown and described.

DESCRIPTION

FIG. 1 is a front perspective view of a storage bag, showing my design.

FIG. 2 is a front elevation view thereof.

FIG. 3 is a rear elevation view thereof.

FIG. 4 is a left side elevation view thereof.

FIG. 5 is a right side elevation view thereof.

FIG. 6 is a top plan view thereof; and,

FIG. 7 is a bottom plan view thereof.

The broken lines in the drawings depict environmental structure and form no part of the claimed design.

1 Claim, 7 Drawing Sheets

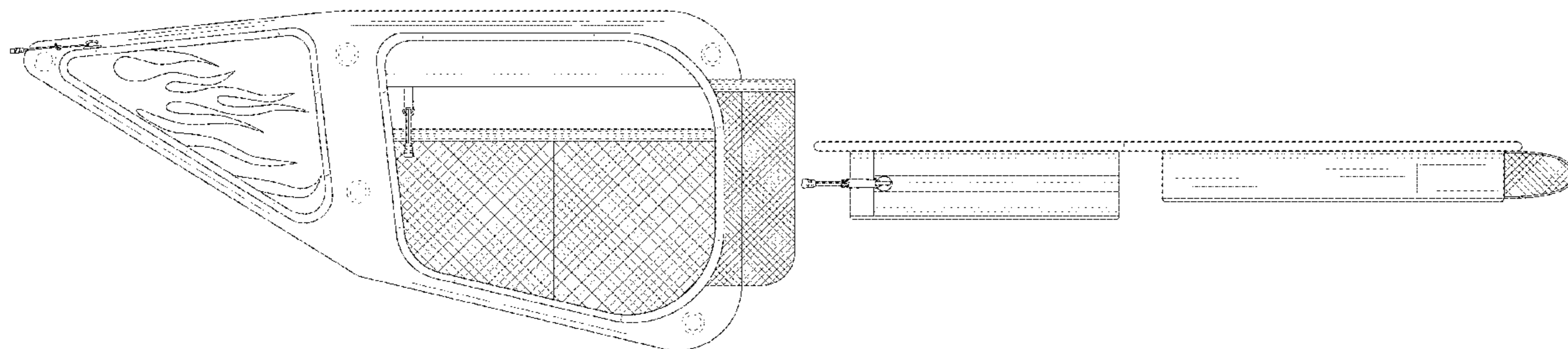

(56)

References Cited

U.S. PATENT DOCUMENTS

D938,105 S * 12/2021 Metz D30/153
2018/0153271 A1 * 6/2018 Higdon, Jr. A45C 1/02

FOREIGN PATENT DOCUMENTS

CN	304910564	* 11/2018
CN	305387122	* 10/2019
KR	300251382.0000	* 1/2000
KR	301063377.0000	* 6/2020
WO	D099344-020	* 2/2018

OTHER PUBLICATIONS

Amazon.ca, Site visited Dec. 7, 2021, Osoce Anti-Theft Shoulder Backpack, First Available Jul. 26, 2017, <https://www.amazon.ca/OSOCE-Anti-Theft-Waterproof-Crossbody-Women%EF%BC%88Black%EF%BC%89/dp/B073ZB894C> (Year: 2017).*

* cited by examiner

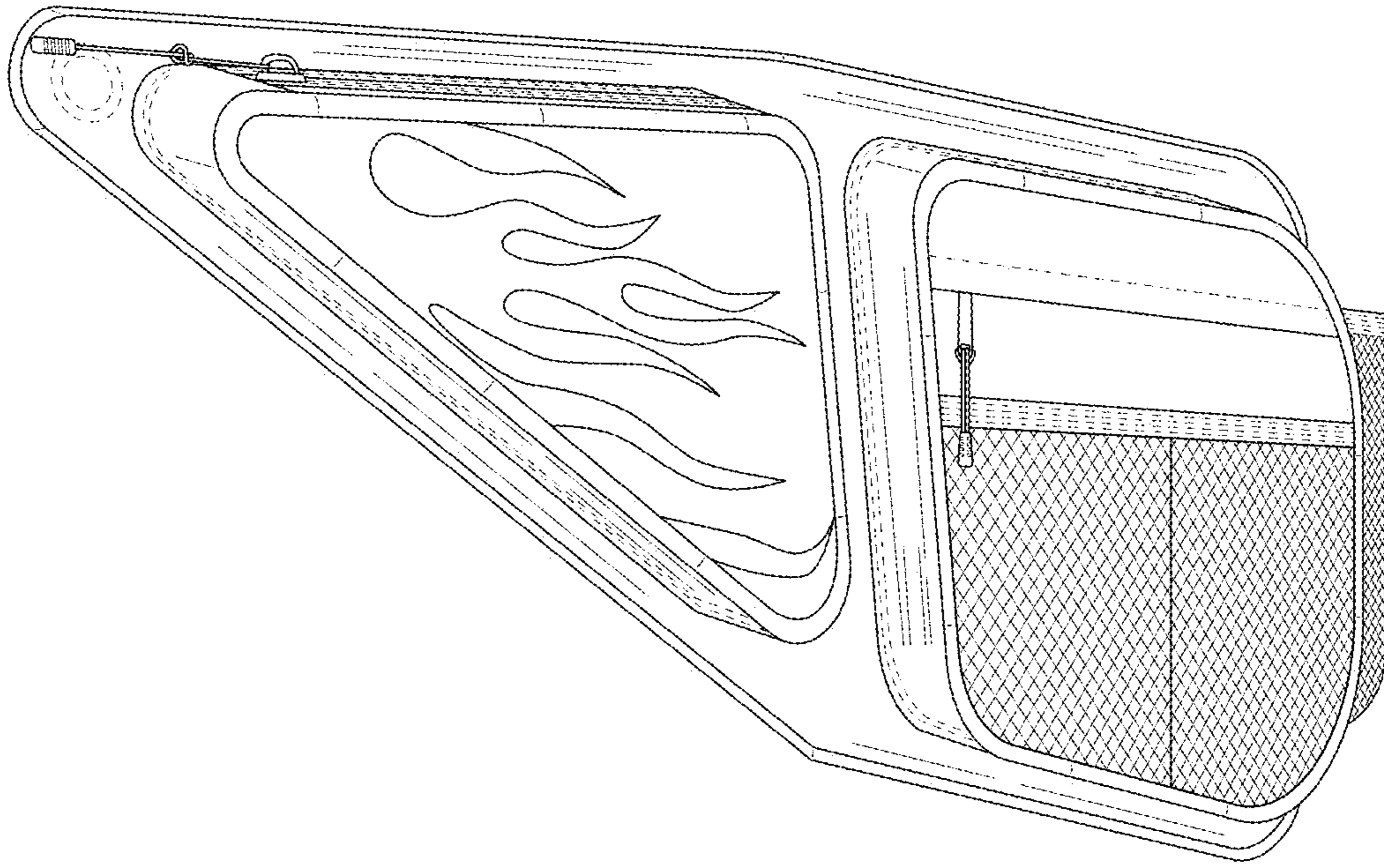

FIG. 1

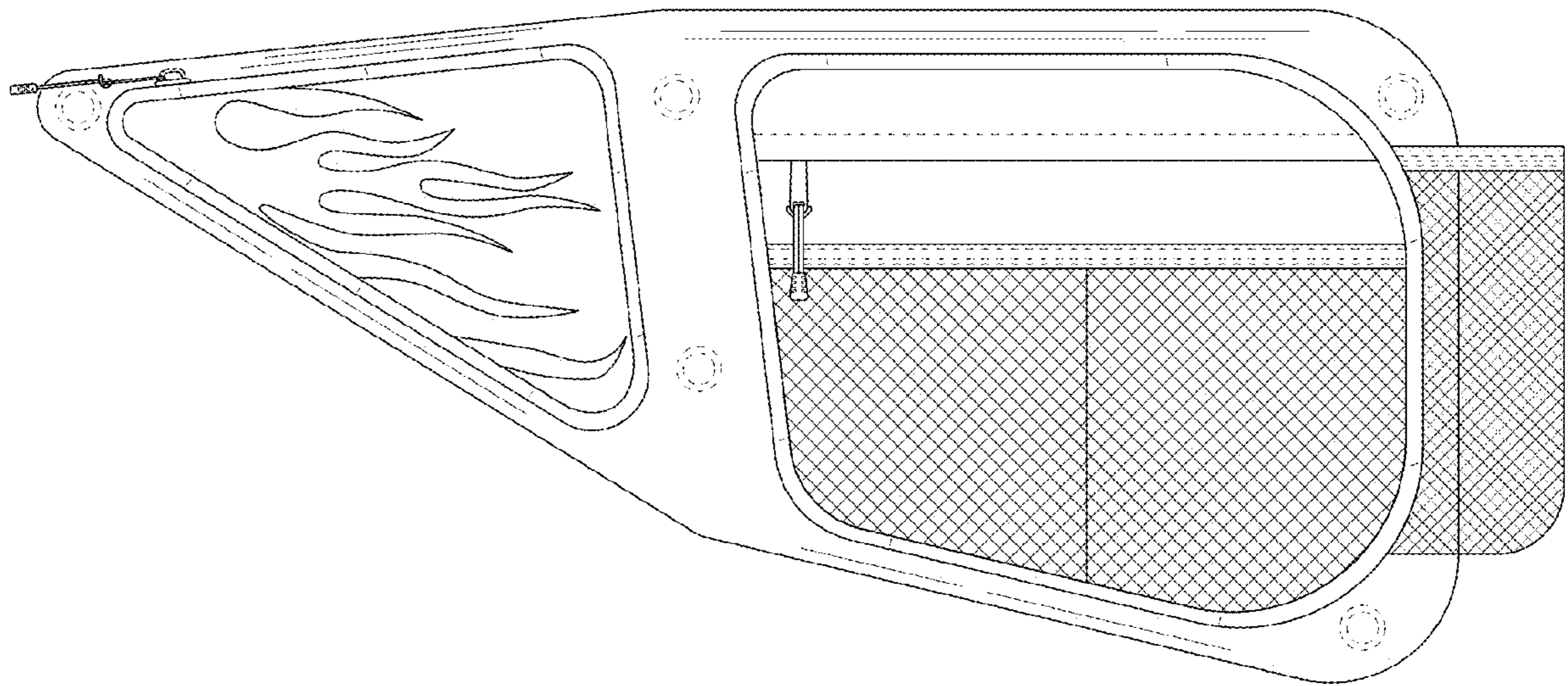

FIG. 2

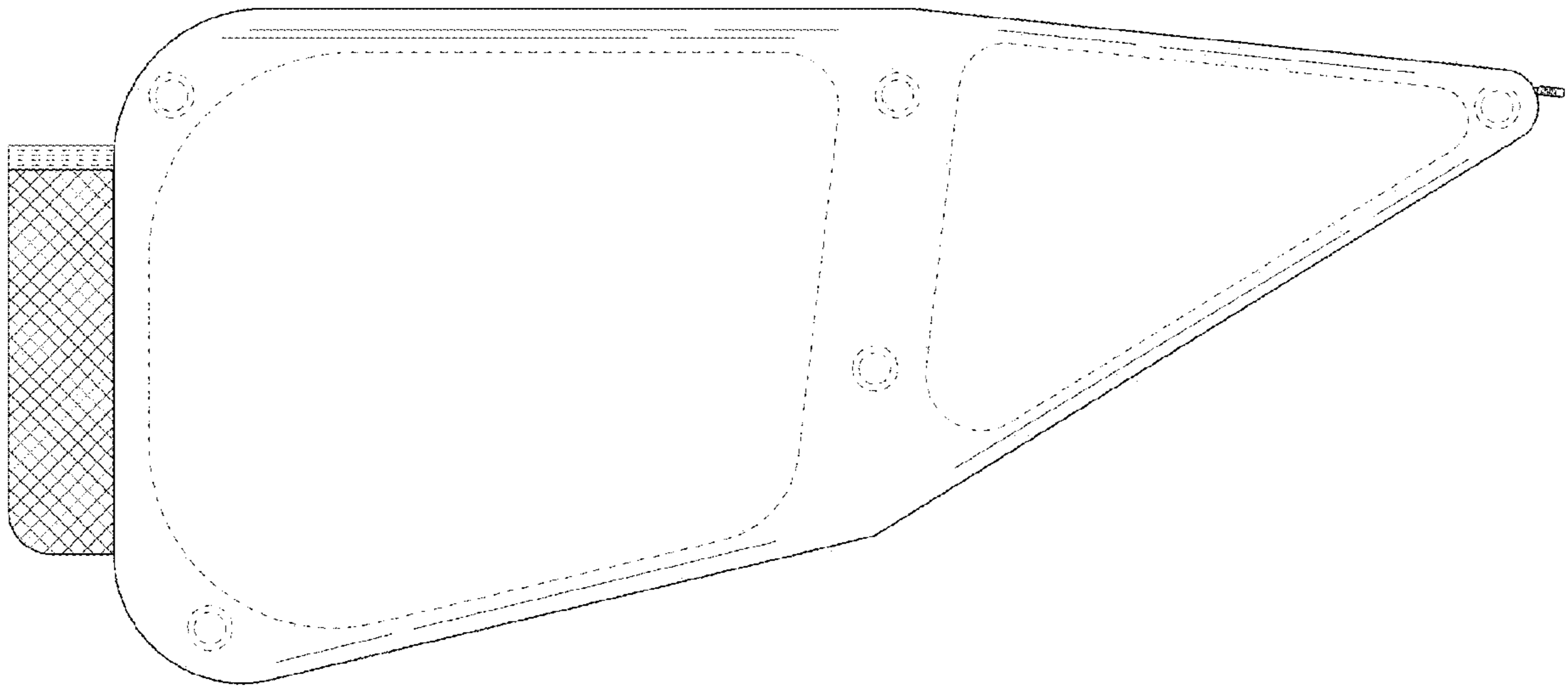

FIG. 3

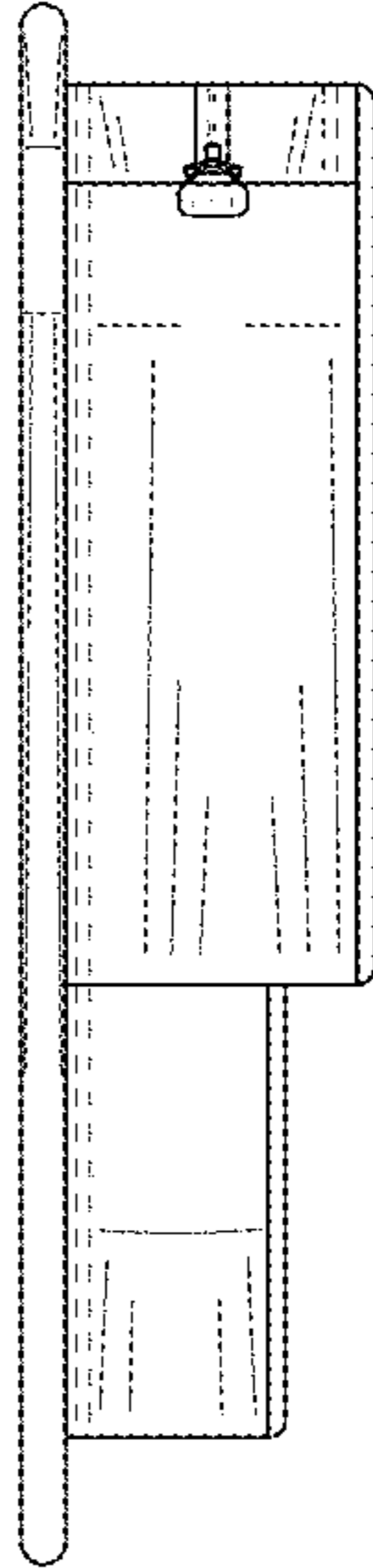

FIG. 4

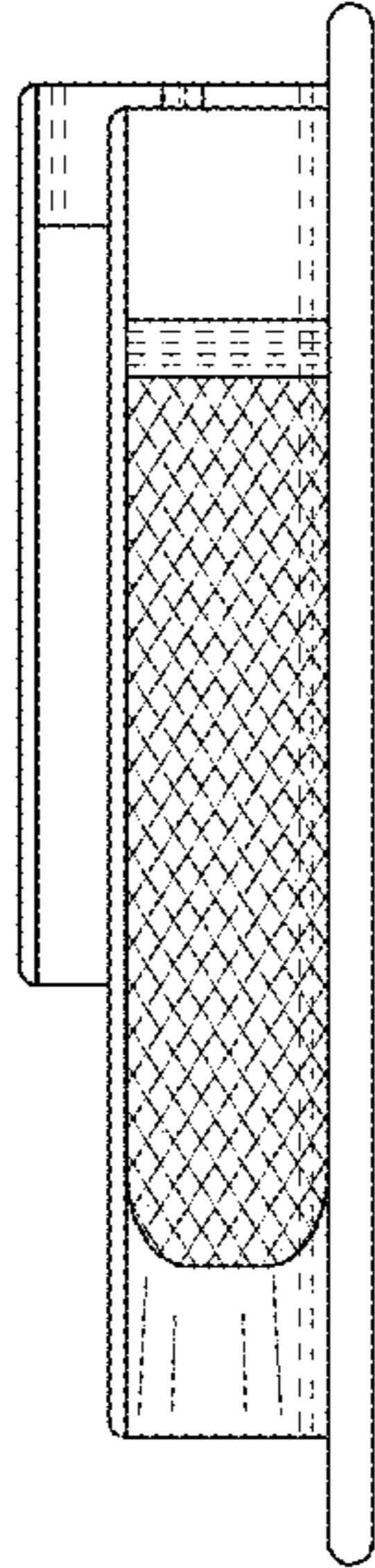

FIG. 5

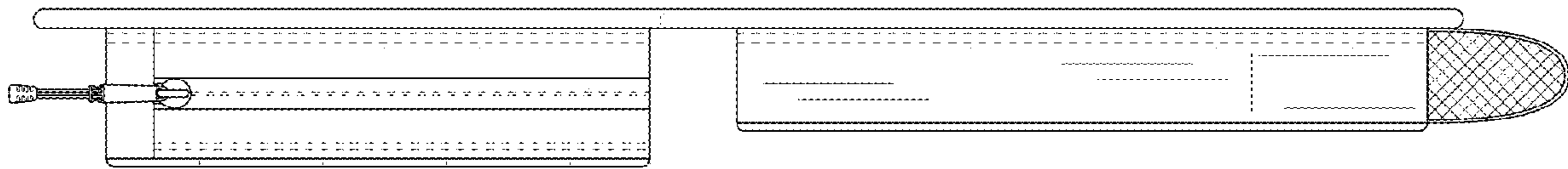

FIG. 6

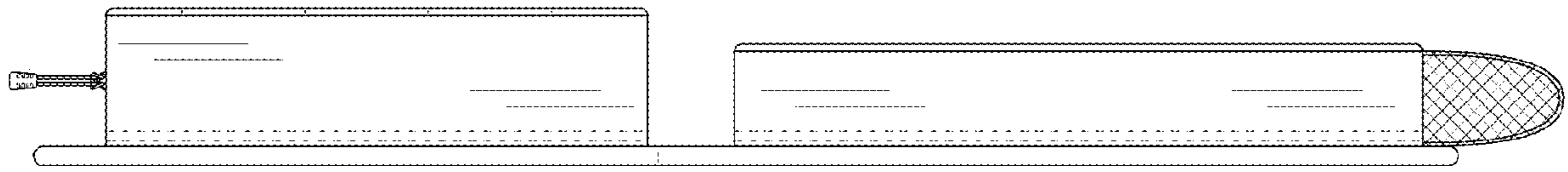

FIG. 7