



US00D956393S

(12) **United States Design Patent** (10) **Patent No.:** **US D956,393 S**
Huang (45) **Date of Patent:** **** Jul. 5, 2022**

(54) **SHOE**

(71) Applicant: **SMART ONLINE SHOPPING TECHNOLOGY GLOBAL LTD,**
Singapore (SG)

(72) Inventor: **Jie Huang,** Singapore (SG)

(73) Assignee: **SMART ONLINE SHOPPING TECHNOLOGY GLOBAL LTD,**
Singapore (SG)

(**) Term: **15 Years**

(21) Appl. No.: **29/758,551**

(22) Filed: **Nov. 17, 2020**

(51) **LOC (13) Cl.** **02-04**

(52) **U.S. Cl.**
USPC **D2/910; D2/909**

(58) **Field of Classification Search**
USPC D2/902-908, 909-915, 919-927, 946,
D2/965, 970; 36/9 R, 73, 71.5, 7.1 R,
36/58.6, 136, 132, 72 B, 72 R
CPC A43B 3/10; A43B 3/14; A43B 3/16; A43B
3/20; A43B 3/28; A43B 3/00; A43B 3/04;
A43B 21/00; A43B 23/00; A43B 23/30;
A43B 5/00; A43B 1/10; A43B 1/0063;
A43B 1/009; A43B 1/12; A43B 1/10
See application file for complete search history.

(56) **References Cited**

U.S. PATENT DOCUMENTS

68,822 A *	9/1867	Woodruff	A43B 3/20
				36/7.4
72,164 A *	12/1867	Camp	A43B 3/20
				36/7.4
D216,941 S *	3/1970	Schwartz	D2/910
4,484,398 A *	11/1984	Goodwin	A43B 5/185
				36/73
D339,905 S *	10/1993	Bensley	D2/977
5,425,186 A *	6/1995	Hoyt	A43B 3/26
				36/97

(Continued)

FOREIGN PATENT DOCUMENTS

CN 304930055 * 12/2018
CN 306446710 * 4/2021

(Continued)

OTHER PUBLICATIONS

Santimon, Chelsea Boots Men Suede, (Dec. 22, 2016), Amazon.com, [site visited: Apr. 14, 2022], Available from URL: <https://www.amazon.com/Santimon-Chelsea-Boots-Casual-Formal/dp/B01NCOG8FF?th=1> (Year: 2016).*

(Continued)

Primary Examiner — T Chase Nelson
Assistant Examiner — Jamillah Khalil Abdullah

(57) **CLAIM**

The ornamental design for a shoe, as shown and described.

DESCRIPTION

FIG. 1 is a perspective view of a shoe showing my new design;
FIG. 2 is another perspective view thereof;
FIG. 3 is a front elevational view thereof;
FIG. 4 is a rear elevational view thereof;
FIG. 5 is a left side elevational view thereof;
FIG. 6 is a right side elevational view thereof;
FIG. 7 is a top plan view thereof;
FIG. 8 is a bottom plan view thereof; and,
FIG. 9 is an enlarged view of portion 9 shown in FIG. 1.
The broken lines in the drawings depict portions of the shoe that form no part of the claimed design. The broken lines of alternating length seen in FIGS. 1 and 9 are for the purpose of showing the area of enlargement and also form no part of the claimed design.

1 Claim, 9 Drawing Sheets

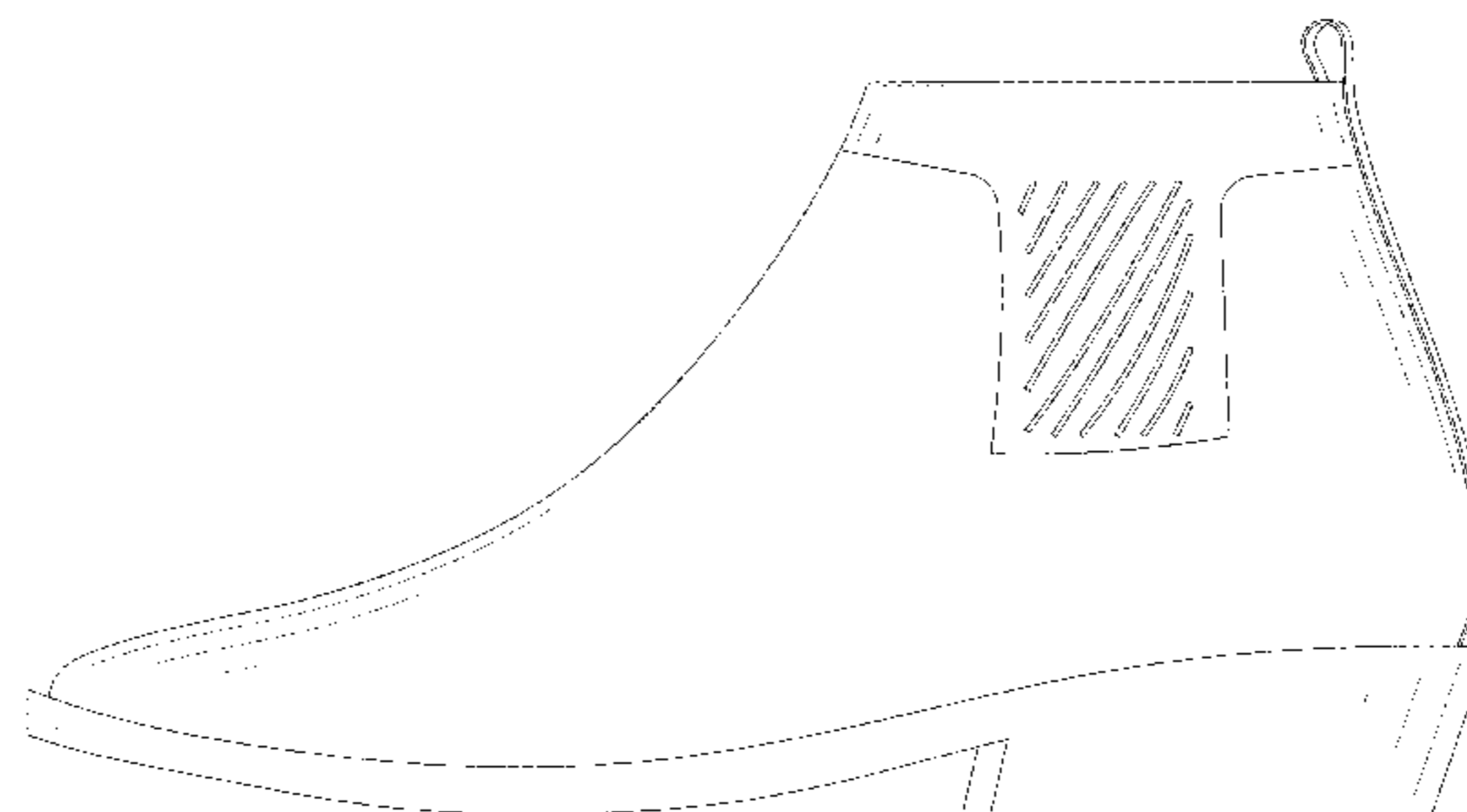
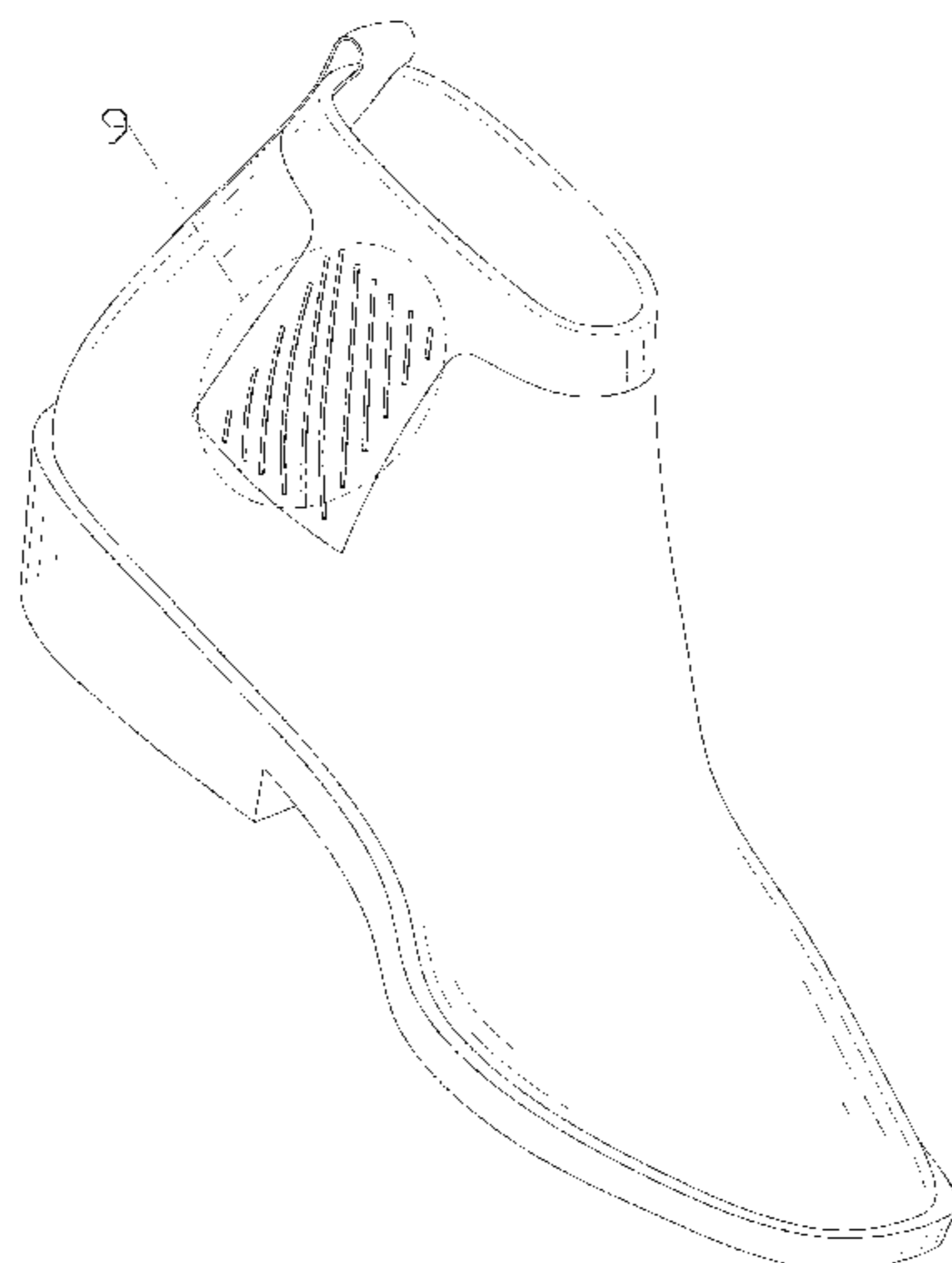

(56)

References Cited

U.S. PATENT DOCUMENTS

D387,546	S	*	12/1997	Pearce	D2/951
D435,958	S	*	1/2001	White	D2/947
D437,474	S	*	2/2001	Agnew	D2/907
D438,367	S	*	3/2001	Huard	D2/907
D441,940	S	*	5/2001	Garcia	D2/909
D459,575	S	*	7/2002	Garcia	A43B 5/185 D2/907
D483,931	S	*	12/2003	Pearce	A43B 3/26 D2/951
D502,593	S	*	3/2005	McClaskie	D2/947
D628,366	S	*	12/2010	Ringdal	D2/909
D643,602	S	*	8/2011	Teteriatnikov	D2/977
D737,031	S	*	8/2015	Bizzo	D2/951
D756,080	S	*	5/2016	Slimane	D2/910
D762,354	S	*	8/2016	Slimane	D2/939
D797,413	S	*	9/2017	Philo	D2/910
D813,505	S	*	3/2018	Brown	D2/896
D859,793	S	*	9/2019	Vasyli	A43B 3/20 D2/907
D878,721	S	*	3/2020	Wang	A43B 3/20 D2/947
D883,617	S	*	5/2020	Spring	A43B 23/042 D2/943
D884,321	S	*	5/2020	Wang	D2/947
D909,028	S	*	2/2021	Beaver	D2/912
D919,245	S	*	5/2021	Martin	D2/909
2014/0173935	A1	*	6/2014	Sabbioni	A43B 23/042 36/87

FOREIGN PATENT DOCUMENTS

CN	307184901	*	3/2022
GB	6076037	*	11/2019
GB	6123153	*	3/2021
IN	325796-001-0001	*	7/2020
IN	325798-001-0001	*	10/2020
KR	301068372.0000	*	7/2020
WO	D212291-001	*	1/2021
WO	D212291-002	*	1/2021

OTHER PUBLICATIONS

Bruno Marc, Mens Chelsea Boots Casual Slip-On, (Jul. 11, 2017), Amazon.com, [site visited: Apr. 15, 2022], Available from URL: https://www.amazon.com/dp/B07SYP4FY2/ref=cm_sw_em_r_mt_dp_MKAVT351QHETAEYYRNQF?_encoding=UTF8&pvc=1 (Year: 2017).*

Totes, Mens Cirrus Ankle Rain Boot, (2020), Target.com, [site visited: Apr. 14, 2022], Available from URL: <https://www.target.com/p/men-s-totes-cirrus-chelsea-rainboots-black-10/-/A-53388590> (Year: 2020).*

Rothys, The Merino Chelsea Boot, (2021), Rothys, [site visited: Apr. 14, 2022], Available from URL: <https://rothys.com/products/mens-chelsea-boot-bourbon#> (Year: 2021).*

Allen Edmonds, Discovery Chelsea Boot, (2021), AllenEdmonds.com, [site visited: Apr. 14, 2022], Available from URL: <https://www.allenedmonds.com/product/mens-discovery-chelsea-boot-3023493/black-ec4022671> (Year: 2021).*

Old Navy, Water-Repellent Pull-On Rain Boots for Women, (2021), OldNavy.com, [site visited: Apr. 14, 2022], Available from URL: <https://oldnavy.gap.com/browse/product.do?pid=100307032&pcid=999&vid=1&&searchText=Water-Repellent%20Pull-On%20Rain%20Boots%20For%20Women#pdp-page-content> (Year: 2021).*

Rothys, The Chelsea, (2021), Rothys.com, [site visited: Apr. 15, 2022], Available from URL: <https://rothys.com/products/the-chelsea-black#> (Year: 2021).*

Manufactum, Ladies Chelsea Boot, (2022), Manufactum.com, [site visited: Apr. 14, 2022], Available from URL: <https://www.manufactum.com/ladies-chelsea-boot-a87217/> (Year: 2022).*

Perry Ellis, Chris Boot, (2022), Perry Ellis, [site visited: Apr. 14, 2022], Available from URL: <https://www.perryellis.com/products/chris-boot-black-pejsn190rt-010> (Year: 2022).*

Banana Republic, Kinley Leather Crepe-Sole Chelsea Boot, (2022), Banana Republic, [site visited: Apr. 14, 2022], Available from URL: <https://bananarepublic.gap.com/browse/product.do?pid=801254002&pcid=999&vid=1&&searchText=Kinley%20Leather%20Crepe-Sole%20Chelsea%20Boot#pdp-page-content> (Year: 2022).*

Banana Republic, Tanner Chelsea Boot, (2022), BananaRepublic.com, [site visited: Apr. 14, 2022], Available from URL: https://bananarepublic.gap.com/browse/product.do?pid=744125002&rrec=true&mink=5001,1,product_brproduct1_rr_0&clink=1#pdp-page-content (Year: 2022).*

Dr. Martens, 2976 Leather Casual Chelsea Boots, (2022), DrMartens.com, [site visited: Apr. 14, 2022], Available from URL: https://www.drmartens.com/us/en/2976-leather-casual-chelsea-boots/p/26002001?gclid=CjwKCAjw6dmSBhBkEiwA_W-EoD_0VPG_b1RBLC-JJfmDCplhc19DsEuZVNx1QIV2GRLCQPrmKs0obBoC1qwQAvD_BwE (Year: 2022).*

Chooka, Eastlake Waterproof Chelsea Boot, (2022), Nordstrom Rack, [site visited: Apr. 14, 2022], Available from URL: <https://www.nordstromrack.com/s/chooka-eastlake-waterproof-chelsea-boot-women/6165671?origin=keywordsearch-personalizedsort&breadcrumb=Home%2FAll%20Results&color=314> (Year: 2022).*

Deer Stags, Rockland Chelsea Boot, (2022), Nordstrom Rack, [site visited: Apr. 14, 2022], Available from URL: <https://www.nordstromrack.com/s/deer-stags-rockland-chelsea-boot/6186186?origin=keywordsearch-personalizedsort&breadcrumb=Home%2FAll%20Results&color=248> (Year: 2022).*

Sorel, Emelie II Chelsea, (2022), Zappos.com, [site visited: Apr. 14, 2022], Available from URL: <https://www.zappos.com/p/sorel-emelie-ii-chelsea-fallen-black/product/9532820/color/920149> (Year: 2022).*

Dakota, Life Stride, (2022), Zappos.com, [site visited: Apr. 15, 2022], Available from URL: <https://www.zappos.com/p/lifestride-dakota-black/product/9569113/color/3> (Year: 2022).*

Loeffler Randall, Toni Boot, (2022), Zappos.com, [site visited: Apr. 15, 2022], Available from URL: <https://www.zappos.com/a/the-style-room/p/loeffler-randall-toni-black/product/9454306/color/3> (Year: 2022).*

* cited by examiner



FIG. 1

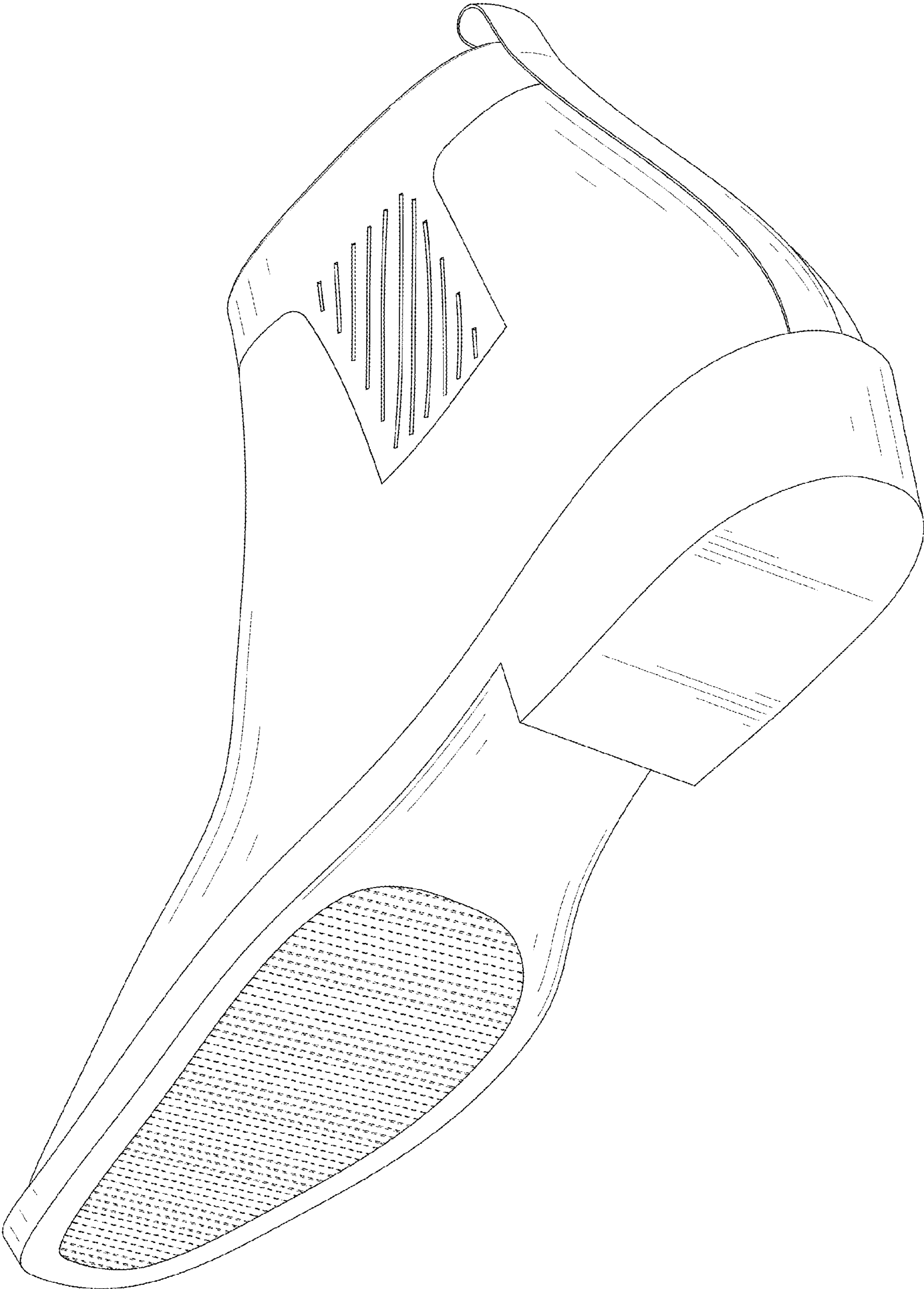

FIG. 2

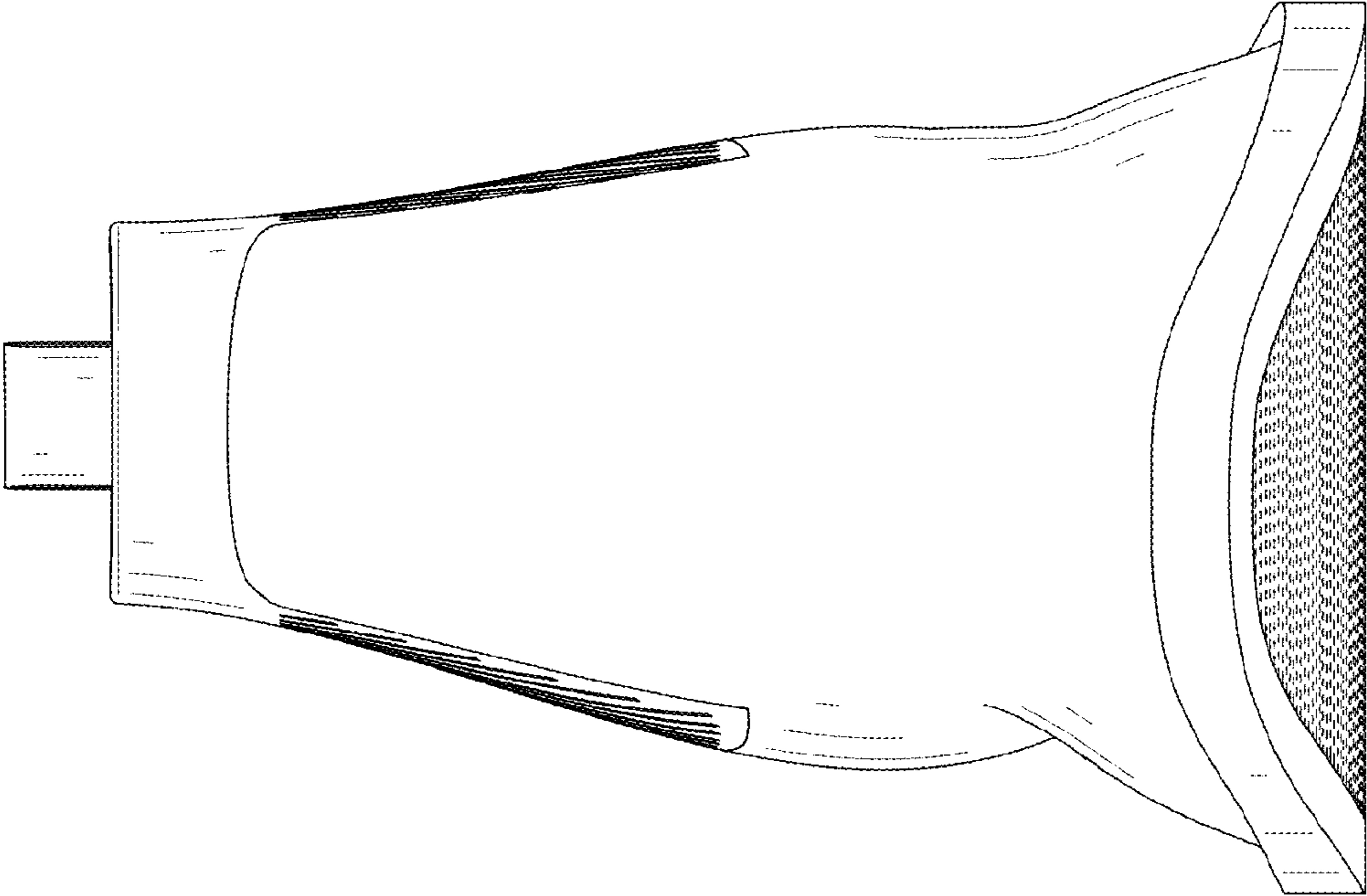

FIG. 3

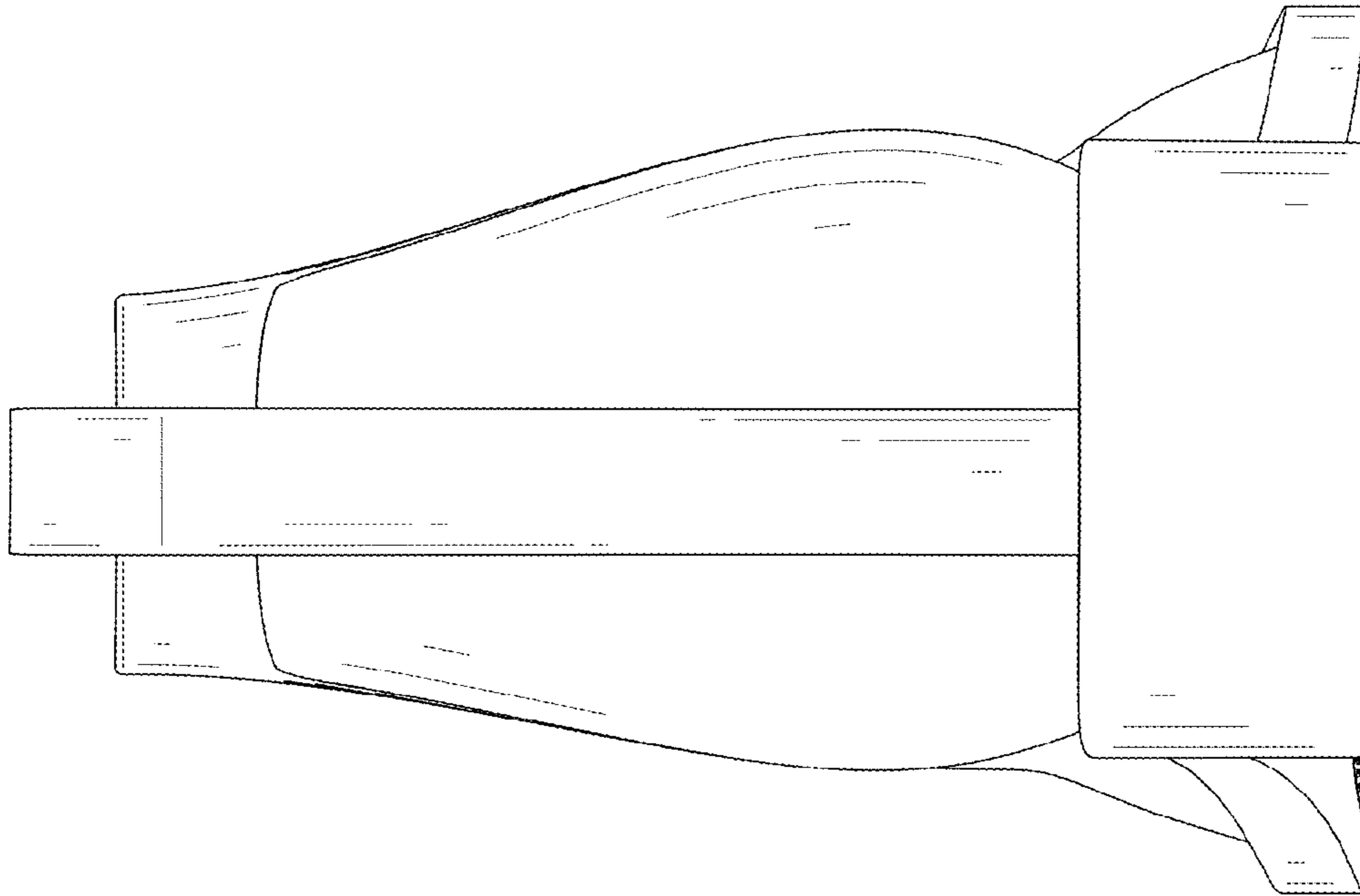

FIG. 4

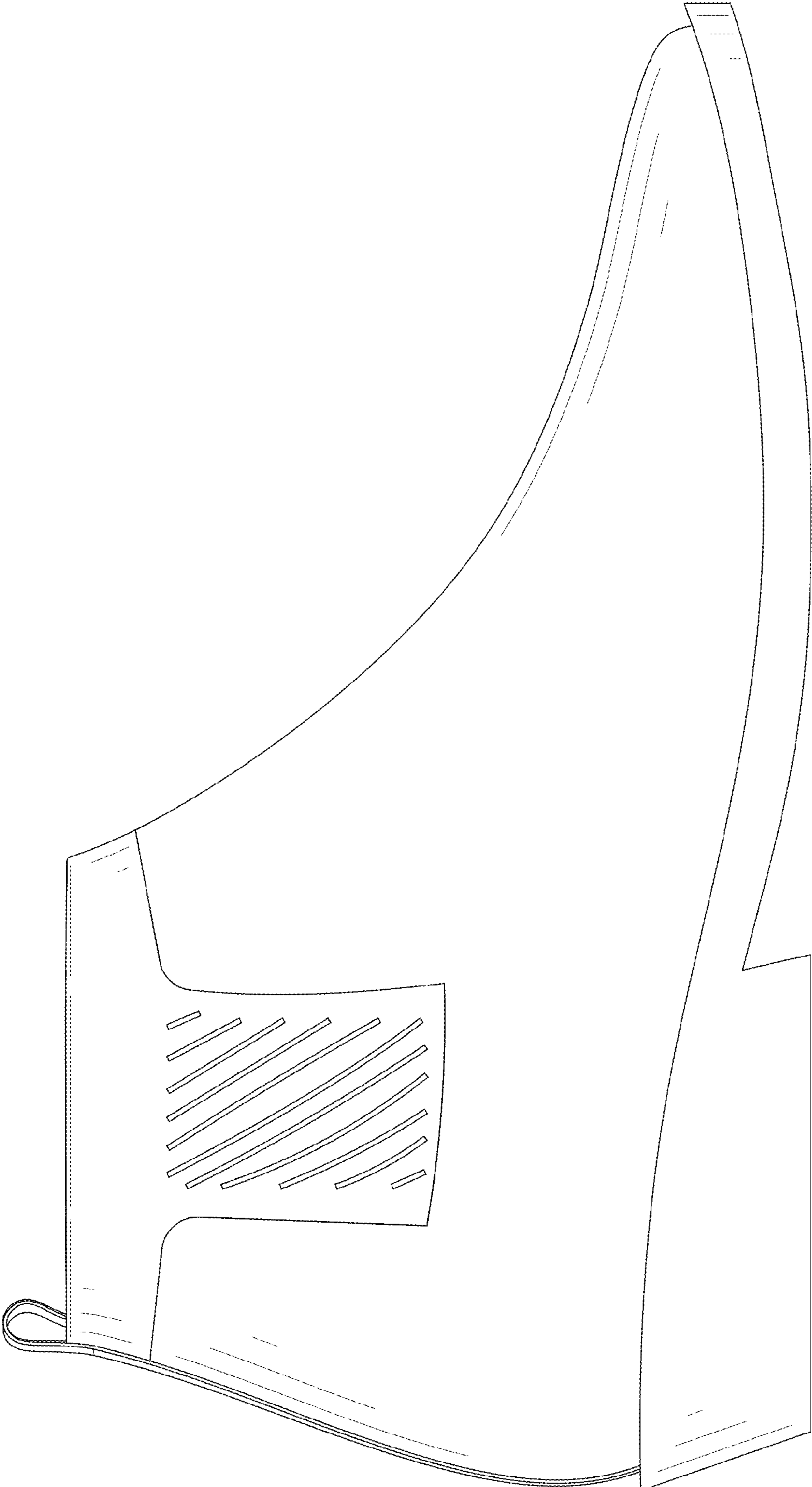

FIG. 5

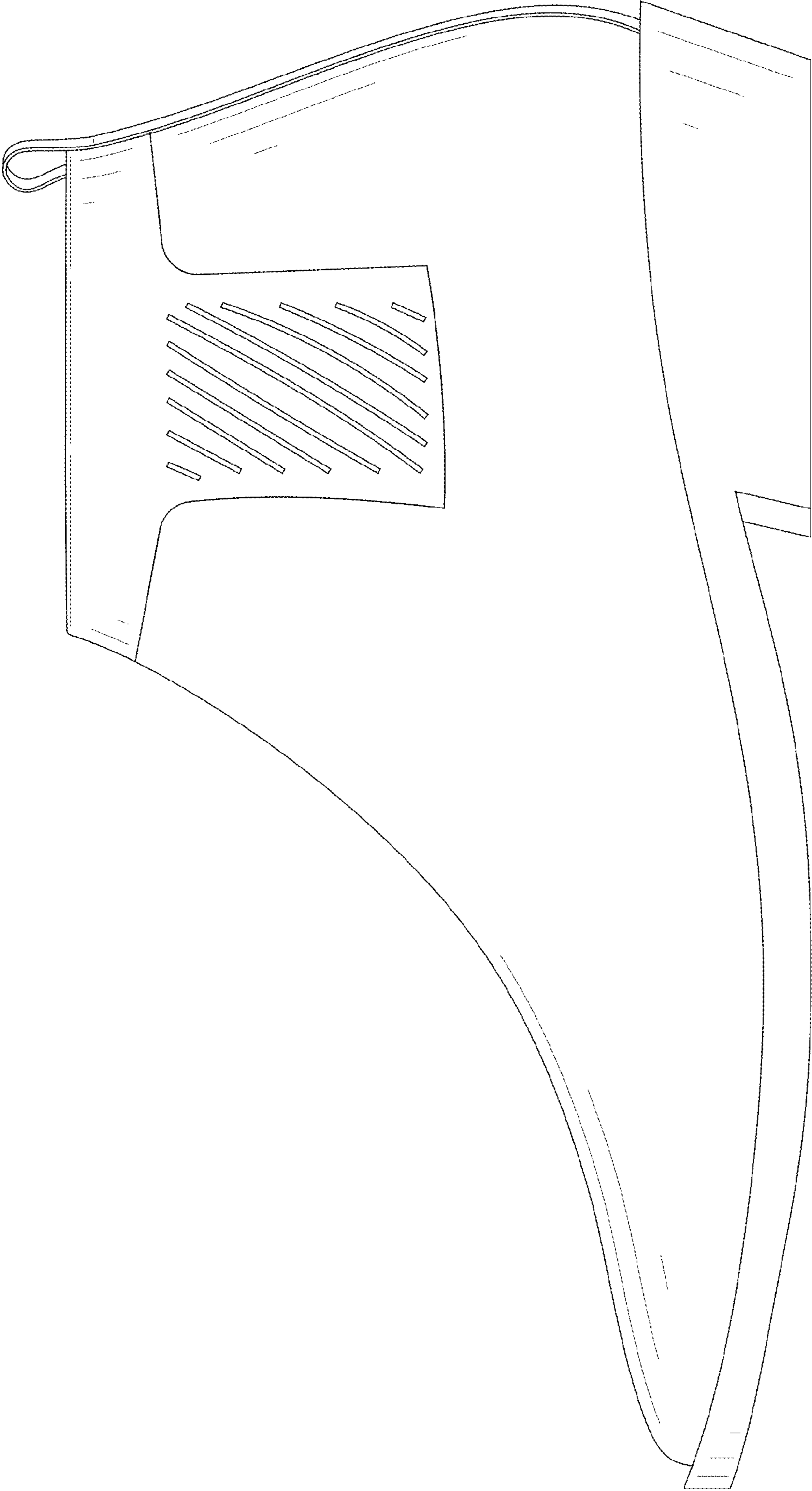

FIG. 6

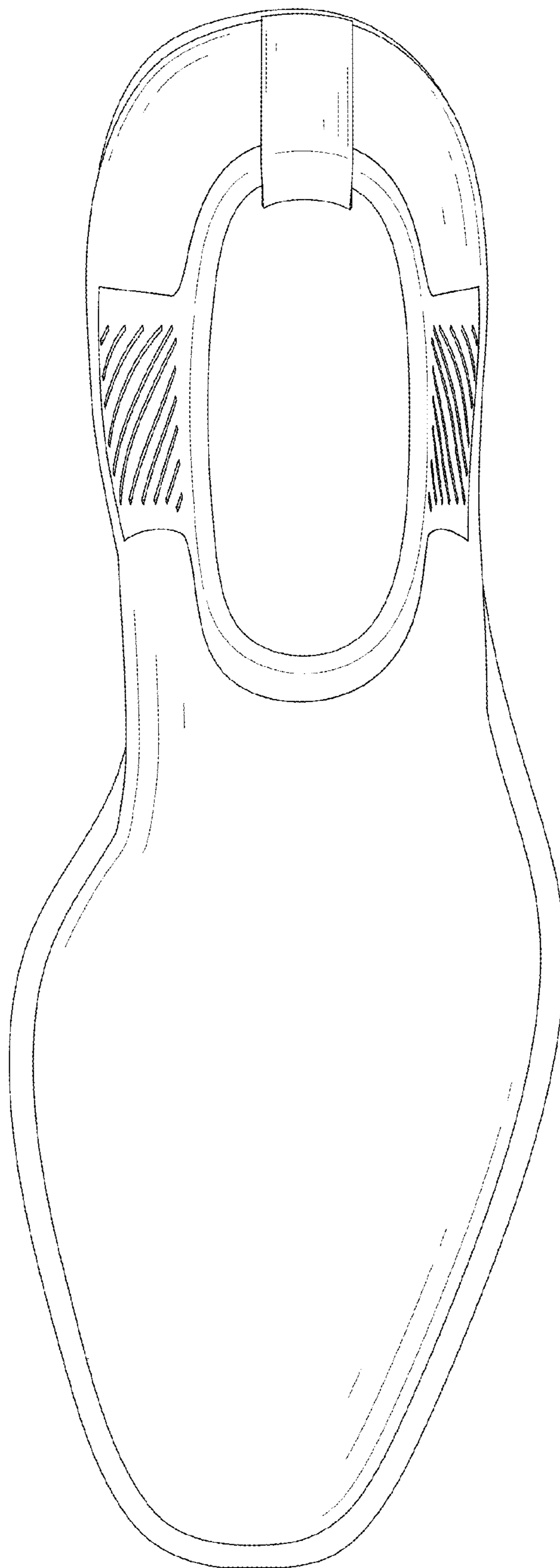

FIG. 7

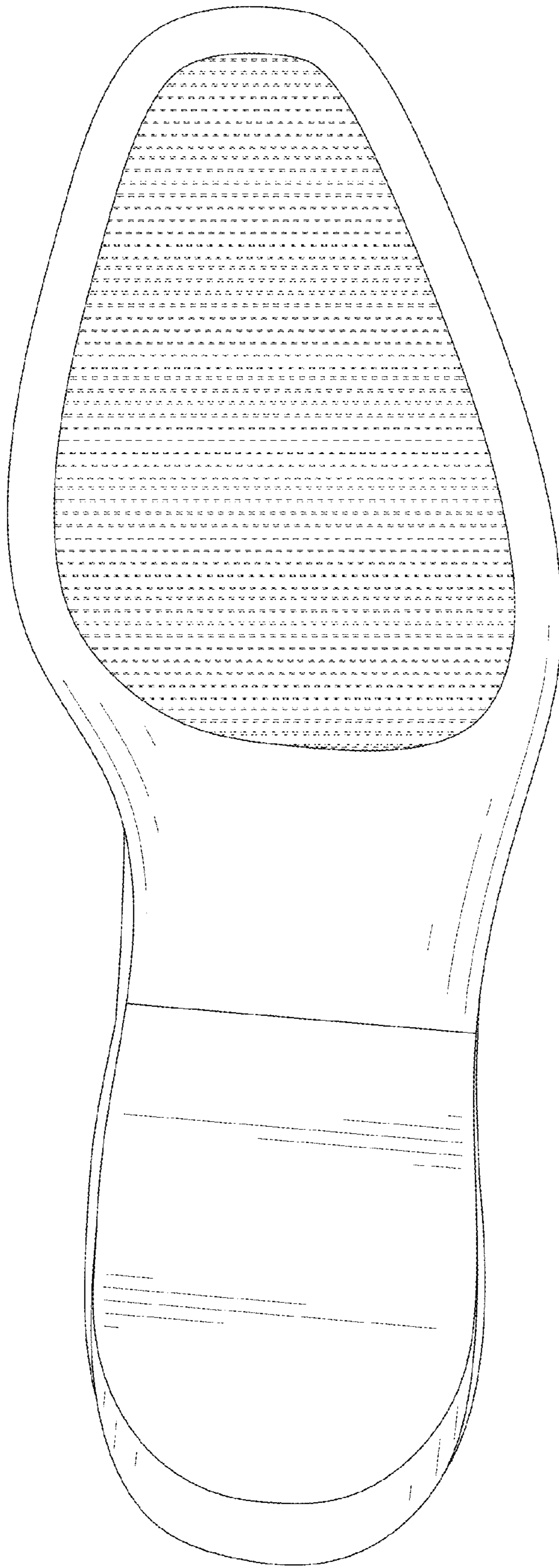

FIG. 8

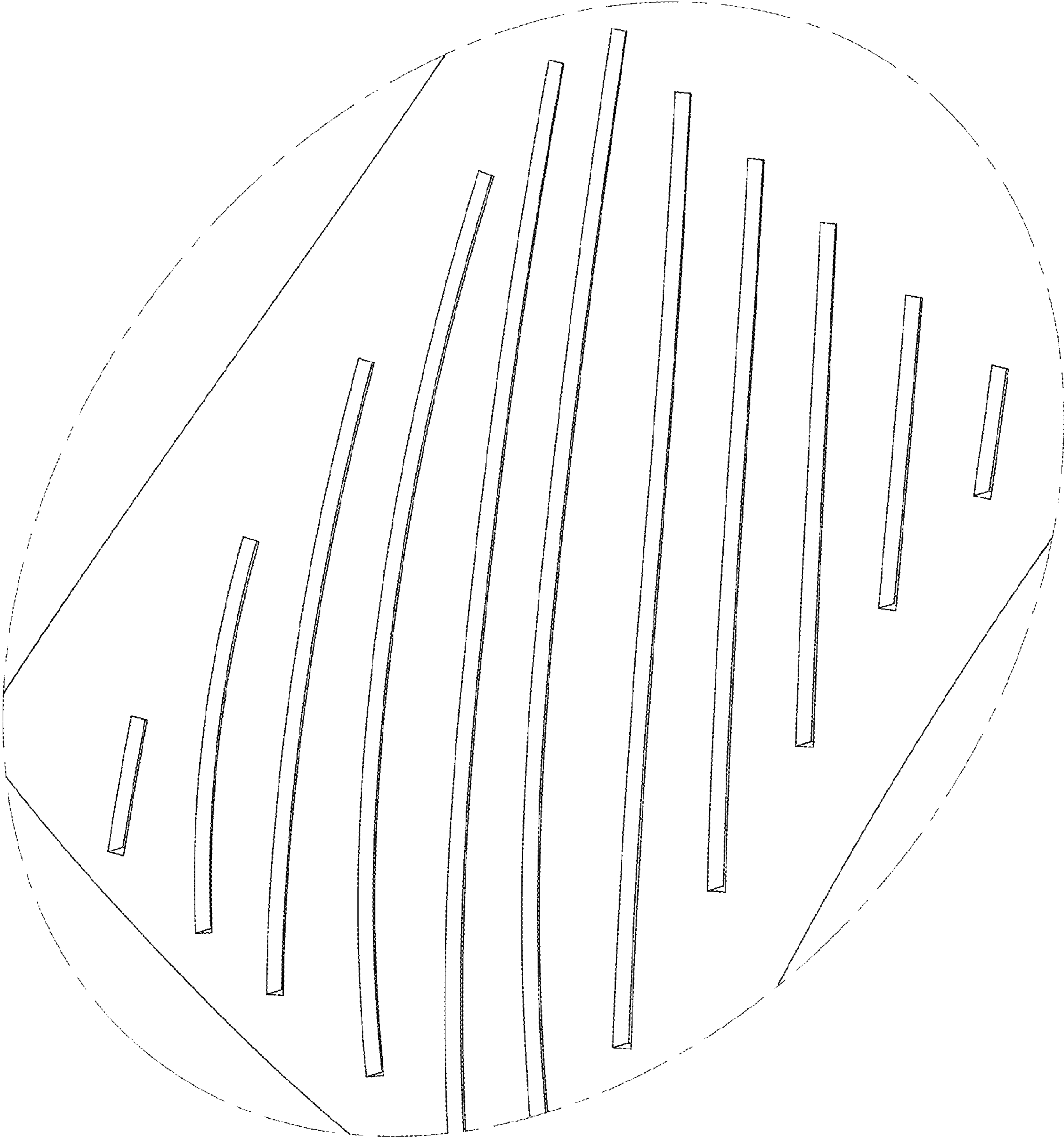

FIG. 9