



US00D956390S

(12) **United States Design Patent**
Sadler

(10) **Patent No.:** **US D956,390 S**

(45) **Date of Patent:** **** Jul. 5, 2022**

(54) **CUFF**

(71) Applicant: **Signature Cuffs LLC**, Fort Worth, TX (US)

(72) Inventor: **Cynthia S Sadler**, Fort Worth, TX (US)

(73) Assignee: **Signature Cuffs LLC**, Fort Worth, TX (US)

(**) Term: **15 Years**

(21) Appl. No.: **29/753,365**

(22) Filed: **Sep. 30, 2020**

(51) **LOC (13) Cl.** **02-02**

(52) **U.S. Cl.**
USPC **D2/858**

(58) **Field of Classification Search**
USPC D2/858, 860, 853
CPC A41B 7/00; A41B 7/10; A41B 3/00; A41B 3/02

See application file for complete search history.

(56) **References Cited**

U.S. PATENT DOCUMENTS

1,097,024	A *	5/1914	Holverson	A41B 7/00 2/124
1,110,187	A *	9/1914	Cooper	A41B 3/00 2/129
1,260,544	A *	3/1918	Hurd	A41B 3/00 2/129
1,263,446	A *	4/1918	Logan	A41B 7/00 2/124
1,270,660	A *	6/1918	Rebert	A41B 7/00 2/124
1,291,970	A *	1/1919	McGaw	A41B 7/00 2/124
1,360,687	A *	11/1920	Rolfe	A41B 7/00 2/123

(Continued)

OTHER PUBLICATIONS

The Detachable Shirt Cuff. Why you Had to Arise by 4:00 AM to Be Dressed by 8:00 A.M., posted to torquedesign.ca. Available date: Dec. 4, 2012 [site visited Mar. 7, 2022] Available: <http://torquedesign.ca/new-blog/2012/12/4/the-detachable-shirt-cuff-why-you-had-to-arise-by-400-am-to-be-dressed-by-800-am> (Year: 2012).*

(Continued)

Primary Examiner — Kevin K Rudzinski

(74) *Attorney, Agent, or Firm* — Timothy G. Ackermann

(57) **CLAIM**

The ornamental design for a cuff, as shown and described.

DESCRIPTION

FIG. 1 is a top front perspective view of a cuff in a first configuration.

FIG. 2 is a bottom front perspective view thereof.

FIG. 3 is a top view thereof.

FIG. 4 is a bottom view thereof.

FIG. 5 is a left view thereof.

FIG. 6 is a right view thereof.

FIG. 7 is a front view thereof.

FIG. 8 is a rear view thereof.

FIG. 9 is a top front perspective view of the cuff in a second configuration.

FIG. 10 is a bottom rear perspective view thereof.

FIG. 11 is a top view thereof.

FIG. 12 is a bottom view thereof.

FIG. 13 is a left view thereof.

FIG. 14 is a right view thereof.

FIG. 15 is a front view thereof; and,

FIG. 16 is a rear view thereof.

The broken lines, where shown, represent portions of the cuff that form no part of the claimed design.

The claimed design also encompasses an embodiment of a cuff that is a mirror image of that shown.

1 Claim, 13 Drawing Sheets

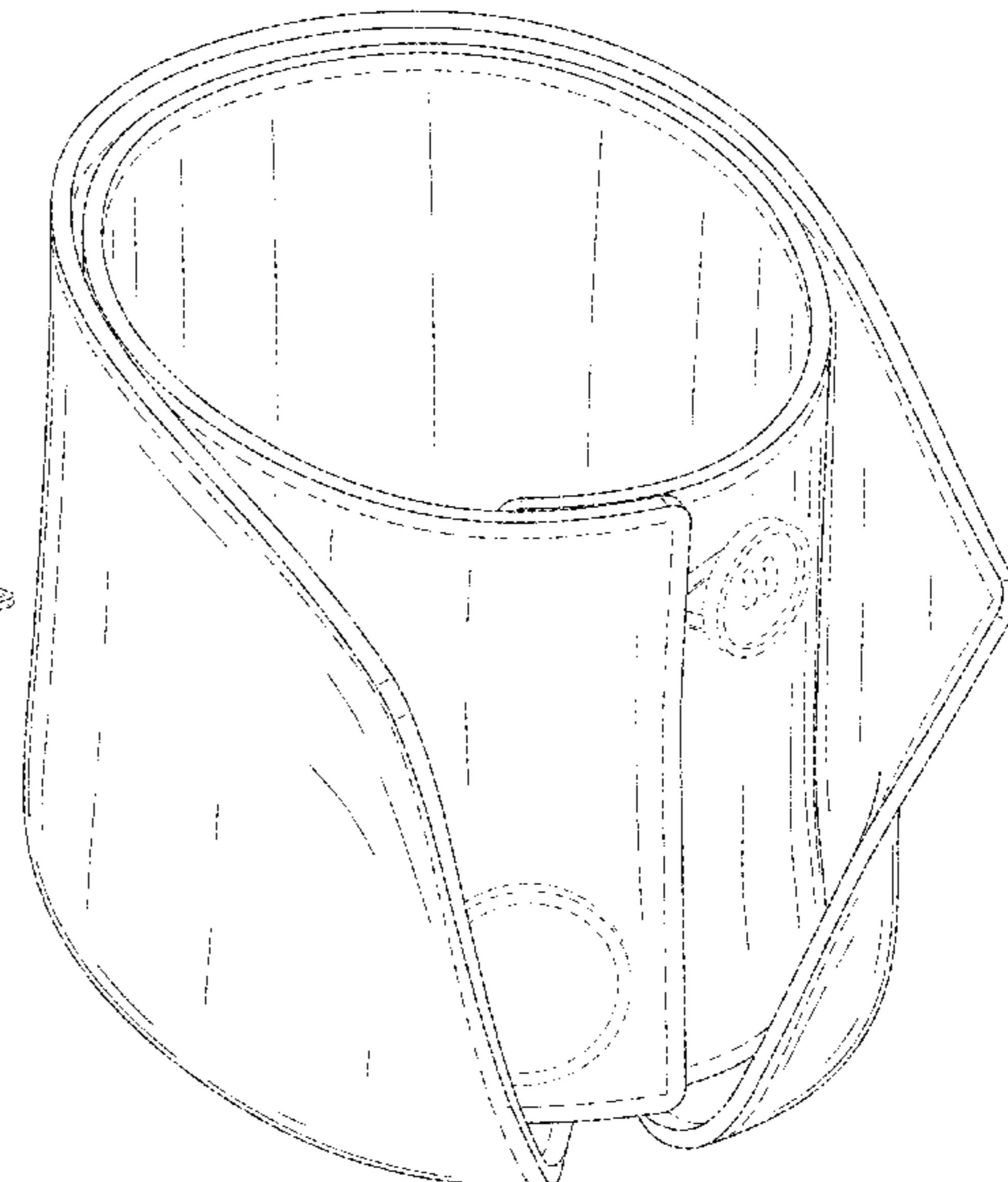
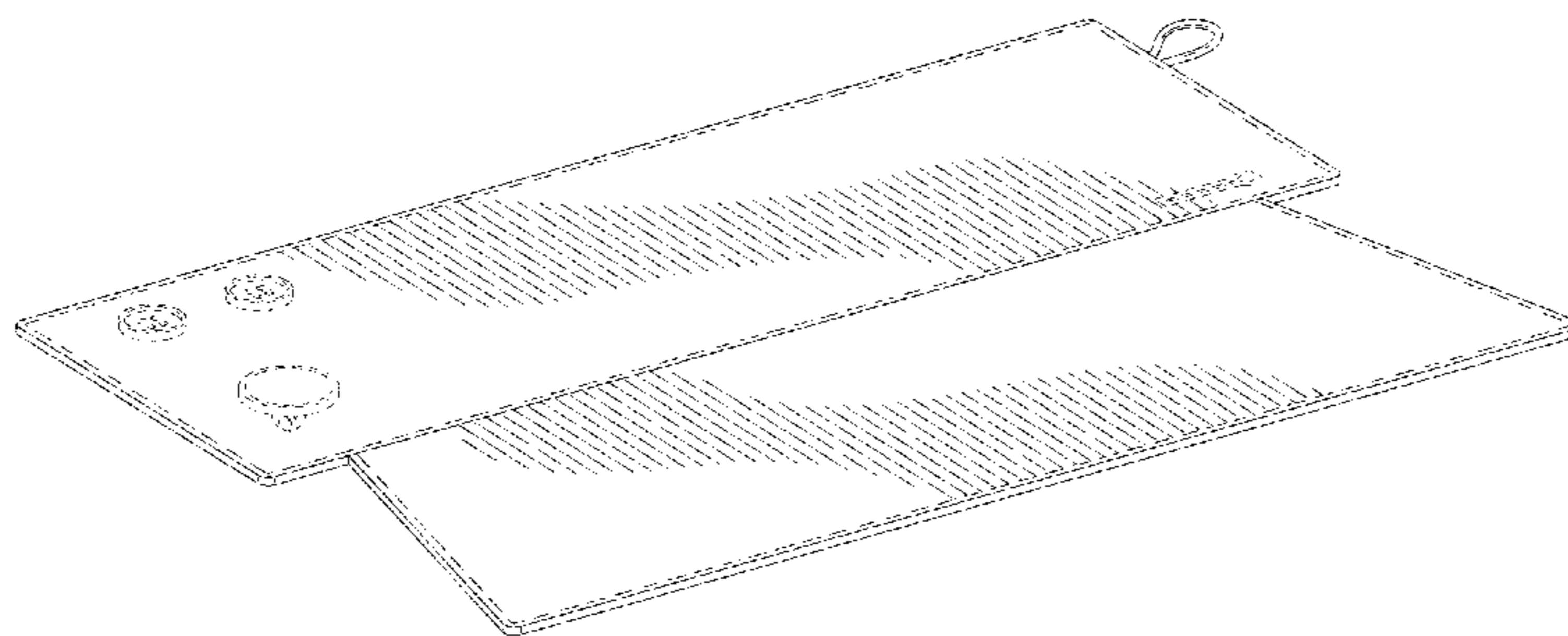

(56)

References Cited

U.S. PATENT DOCUMENTS

1,391,094 A * 9/1921 Brach A41B 7/04
2/124
1,396,204 A * 11/1921 Hess A41B 3/02
2/131
1,478,583 A * 12/1923 Schlesinger A41D 27/16
2/60
1,484,187 A * 2/1924 O'Neill A41B 7/12
2/60
1,489,936 A * 4/1924 Eubank A41B 7/10
2/124
1,620,319 A * 3/1927 Bennett A41B 7/00
112/423
1,670,644 A * 5/1928 Weiner A41B 7/00
D2/858
1,677,504 A * 7/1928 Sweetser A41B 3/08
2/129
1,873,145 A * 8/1932 Packett A41B 3/04
2/139
1,989,638 A * 1/1935 Goldschmidt A41B 7/10
2/123
2,018,187 A * 10/1935 Myntti A41B 7/02
2/123
2,180,758 A * 11/1939 Honigsberg A41B 3/12
2/60
2,447,106 A * 8/1948 Wegener, Jr. A41B 7/06
2/124
2,736,032 A * 2/1956 Bode A41B 7/10
2/124
2,994,885 A * 8/1961 Simpson A41B 7/00
2/123
D193,760 S * 10/1962 Sanders D2/858
3,060,447 A * 10/1962 Dethier A41B 3/06
2/132
D207,090 S * 3/1967 Kay D2/858
D209,385 S * 11/1967 Kay 2/124
3,533,108 A * 10/1970 Feldser A41B 7/06
2/124
3,843,972 A * 10/1974 Weinkle A41B 7/04
2/123

D341,921 S * 12/1993 Trost D2/858
5,274,853 A * 1/1994 Millican A41B 3/02
2/129
D402,441 S * 12/1998 Kelly D2/858
6,212,685 B1 * 4/2001 Kelly A44B 5/00
2/270
6,430,747 B1 * 8/2002 Lee A41B 7/00
2/124
7,146,647 B2 * 12/2006 Krause A41B 3/00
2/129
D646,468 S * 10/2011 Arrindell D2/858
9,009,866 B2 * 4/2015 Blakely A41B 7/04
2/124
D764,768 S * 8/2016 McGrath D2/858
9,756,879 B2 * 9/2017 Roup A41B 1/12
D815,804 S * 4/2018 Cirigliano D2/860
2002/0020001 A1 * 2/2002 Kelly A44B 5/00
2/123
2007/0118955 A1 * 5/2007 Kapadia A41D 27/02
2/69
2013/0318683 A1 * 12/2013 Blakely A41B 7/10
2/124

OTHER PUBLICATIONS

Victorian Collars and Cuffs (for Men) by Kristin Holt, posted to kristinholt.com. Available date: Jul. 1, 2018 [site visited Mar. 8, 2022] Available: <<http://www.kristinholt.com/archives/15633>> (Year: 2018).*

Signature Cuffs Women's Adjustable French Corporate Cuffs posted to amazon.com. Available date: May 17, 2018 [site visited Mar. 7, 2022] Available: <<https://www.amazon.sg/Signature-Cuffs-Womens-Adjustable-Corporate/dp/B082G7Z3VK>> (Year: 2018).*

Alterable Canvas Cuff With Elastic Loop & Button posted amazon.com. Available date: Sep. 4, 2016 [site visited Mar. 8, 2022] Available: <<https://www.amazon.in/Alterable-Elastic-Button-7-1-Diameter-Buttoned/dp/B007IWADUA>> (Year: 2016).*

Style Beyond Cuffs in Boston posted to unfoldid.com. Available date: Jan. 22, 2020 [site visited Mar. 8, 2022] Available: <<https://unfoldid.com/blog/style-beyond-cuffs>> (Year: 2020).*

* cited by examiner

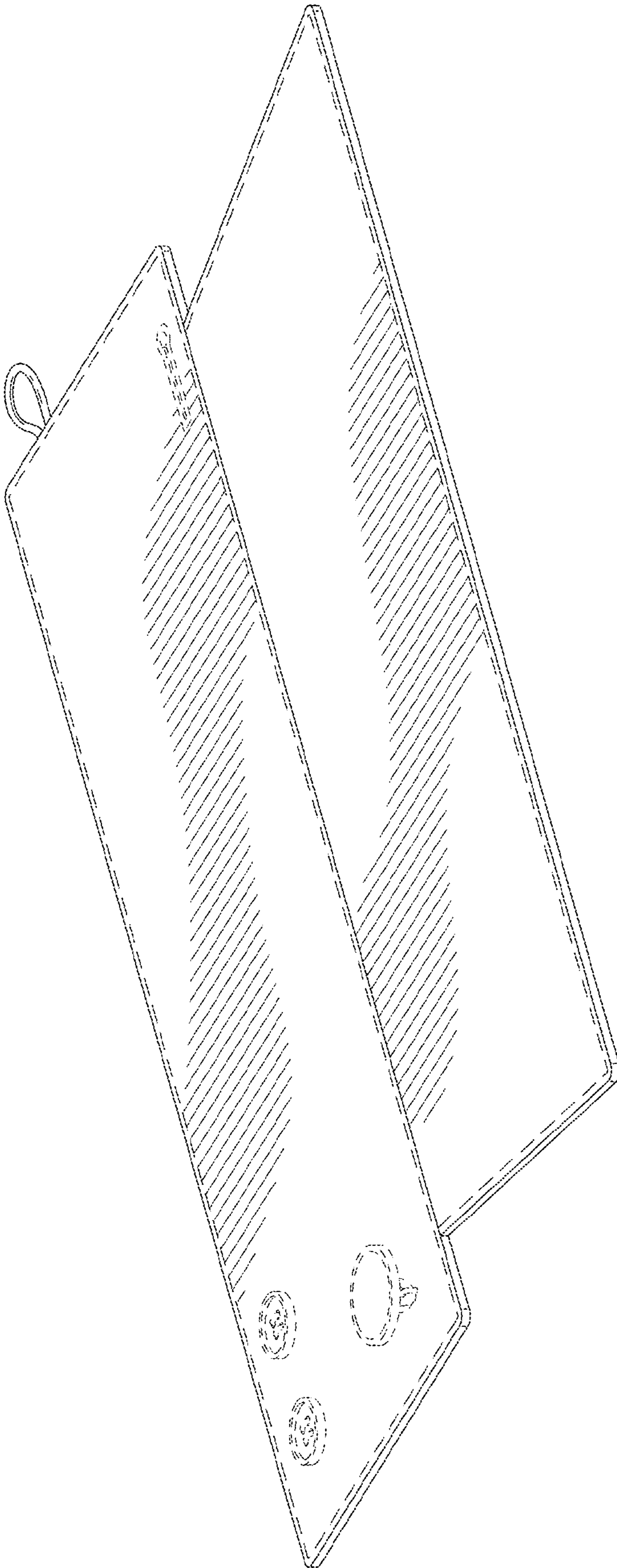
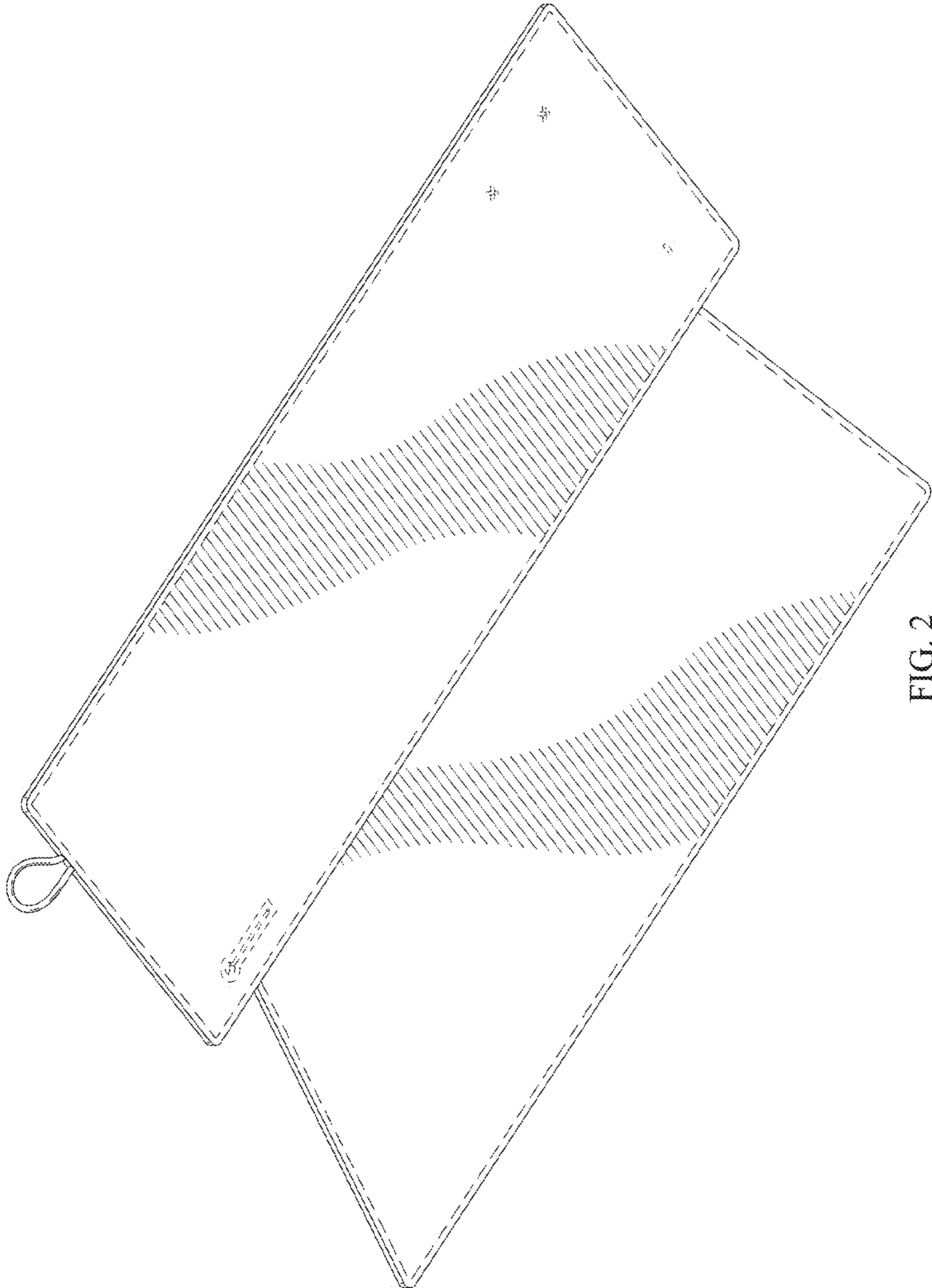

FIG. 1



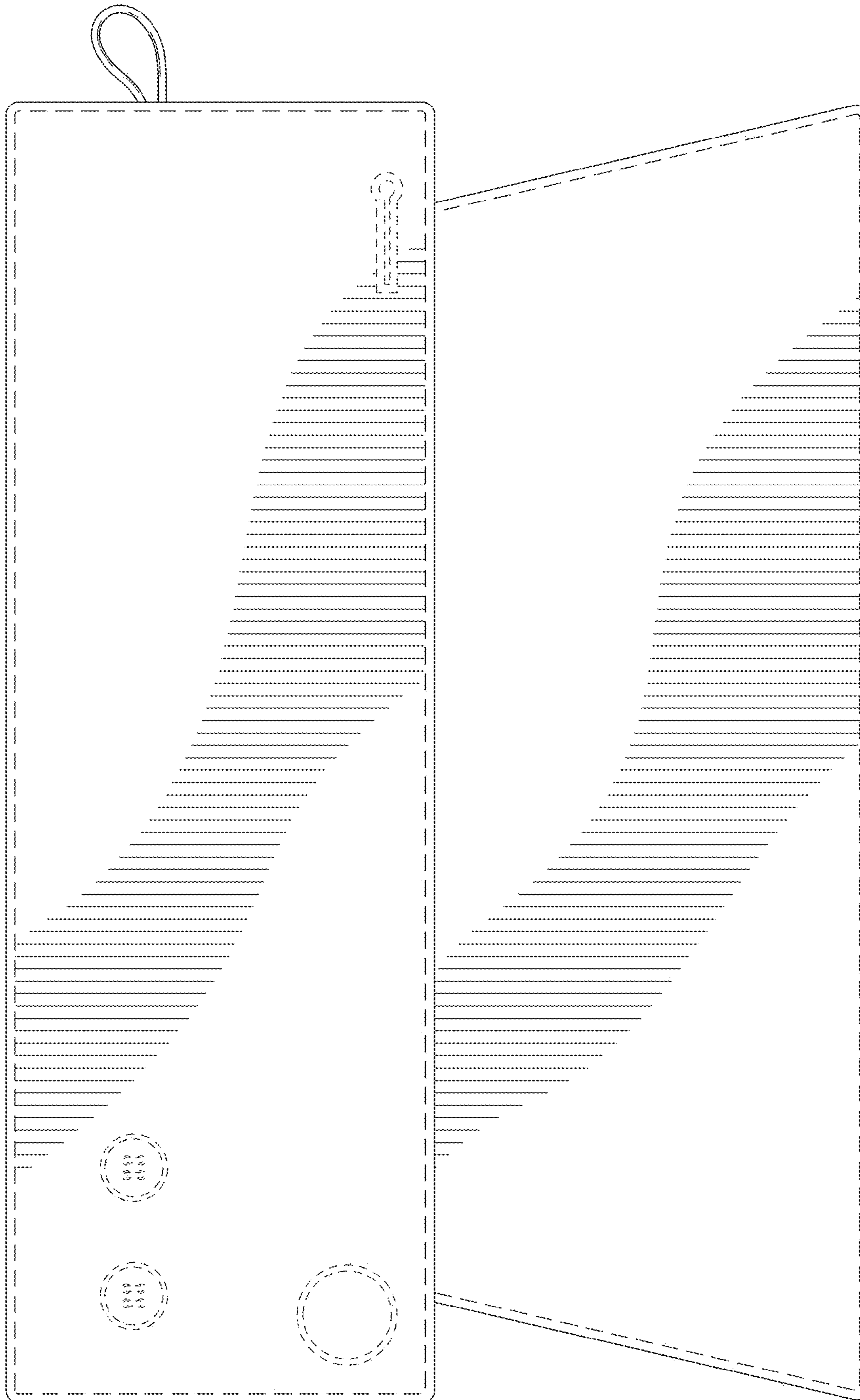

FIG. 3

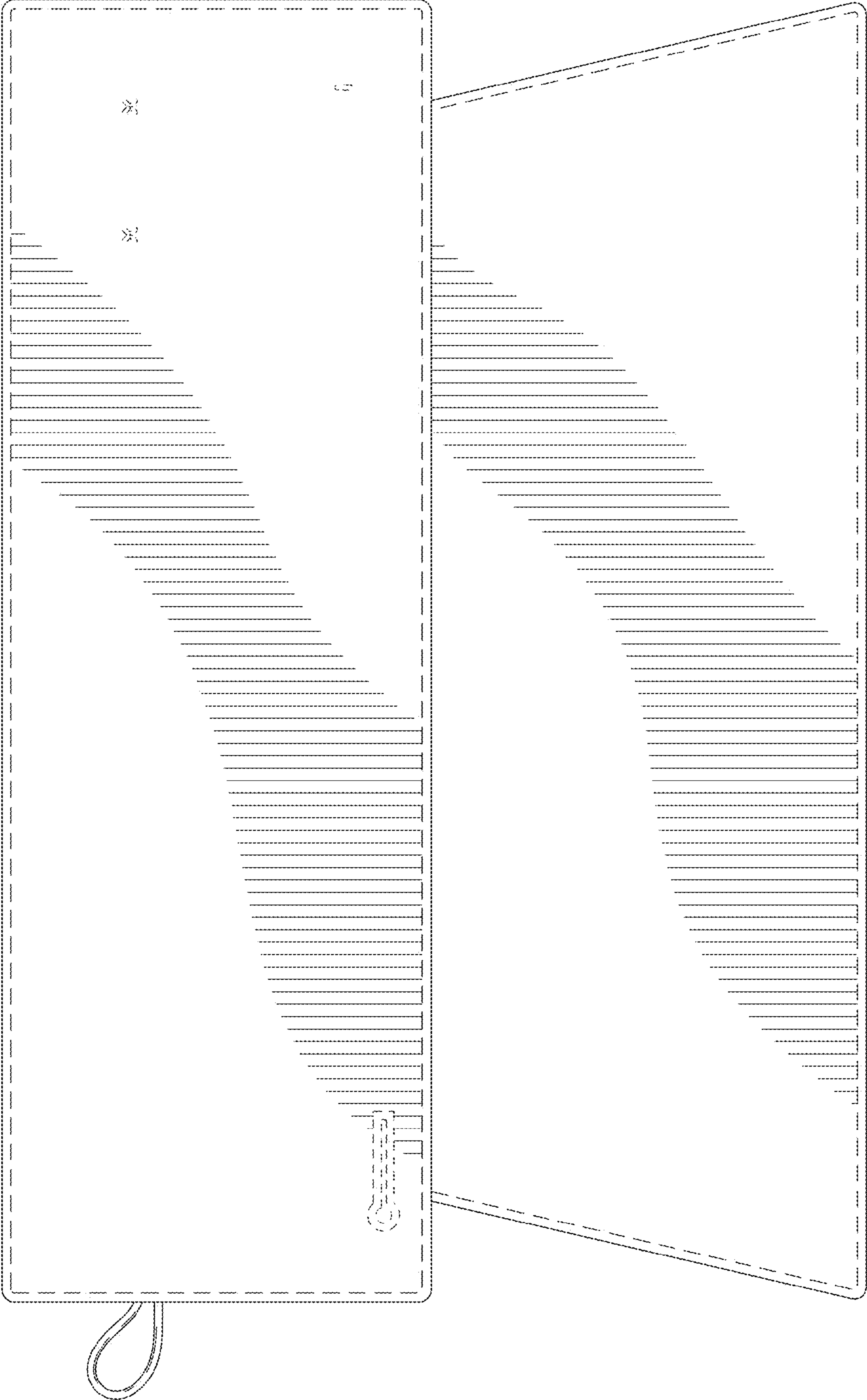

FIG. 4

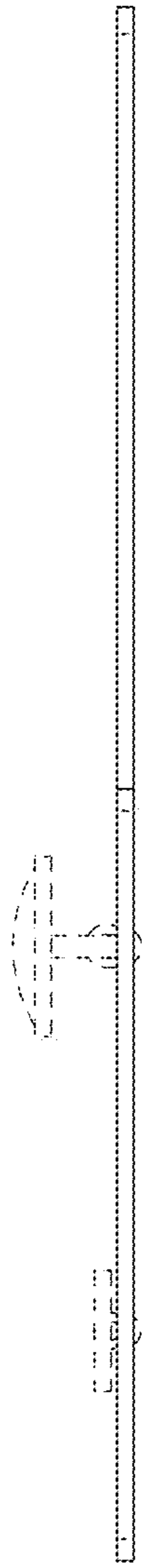

FIG. 5

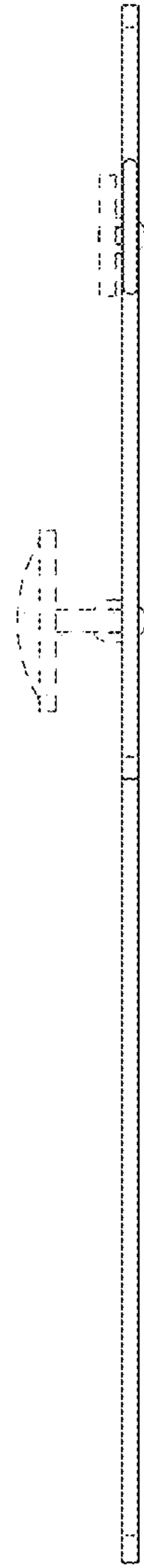

FIG. 6



FIG. 7

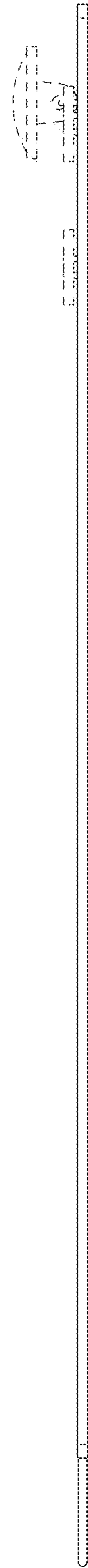

FIG. 8

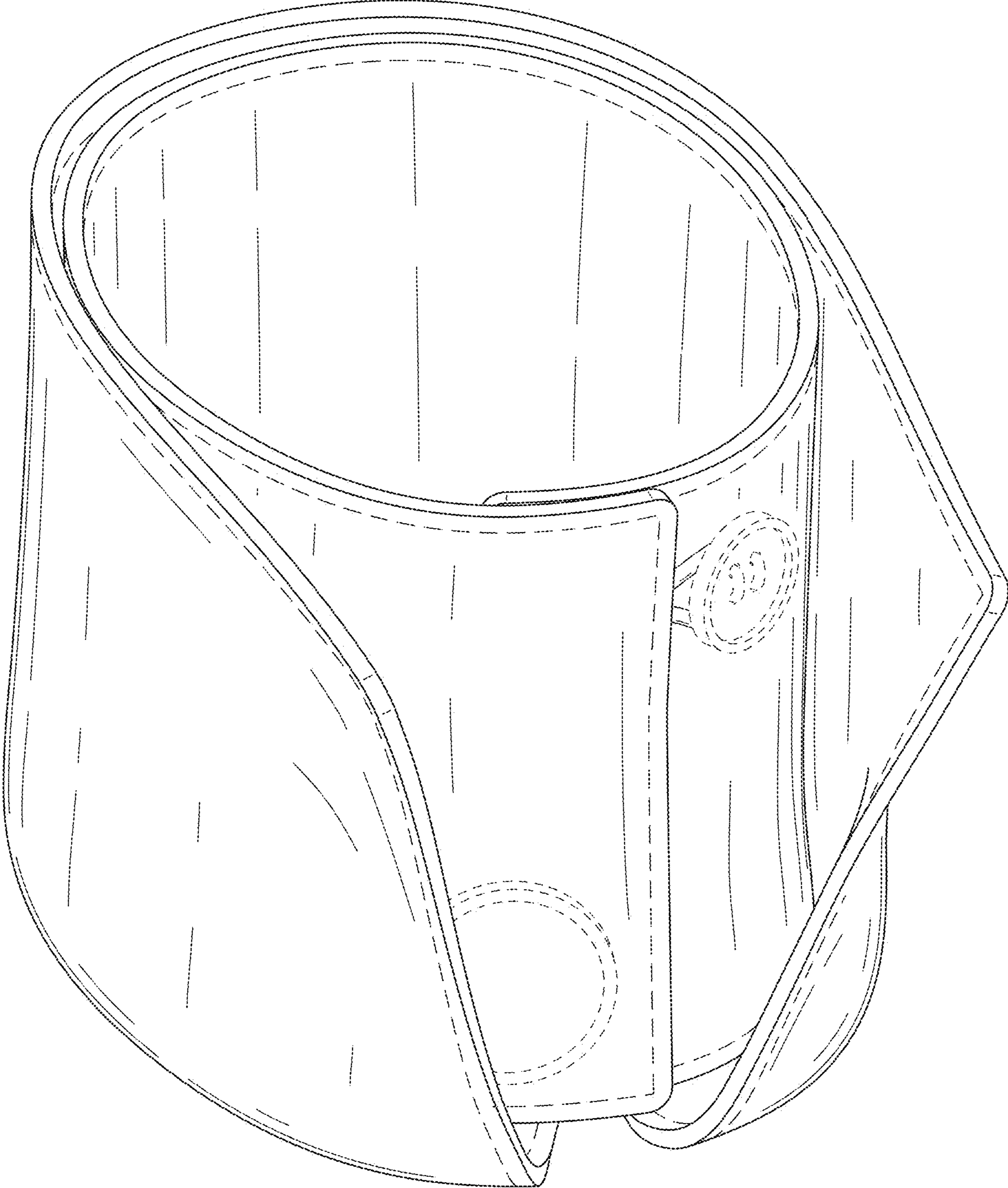

FIG. 9

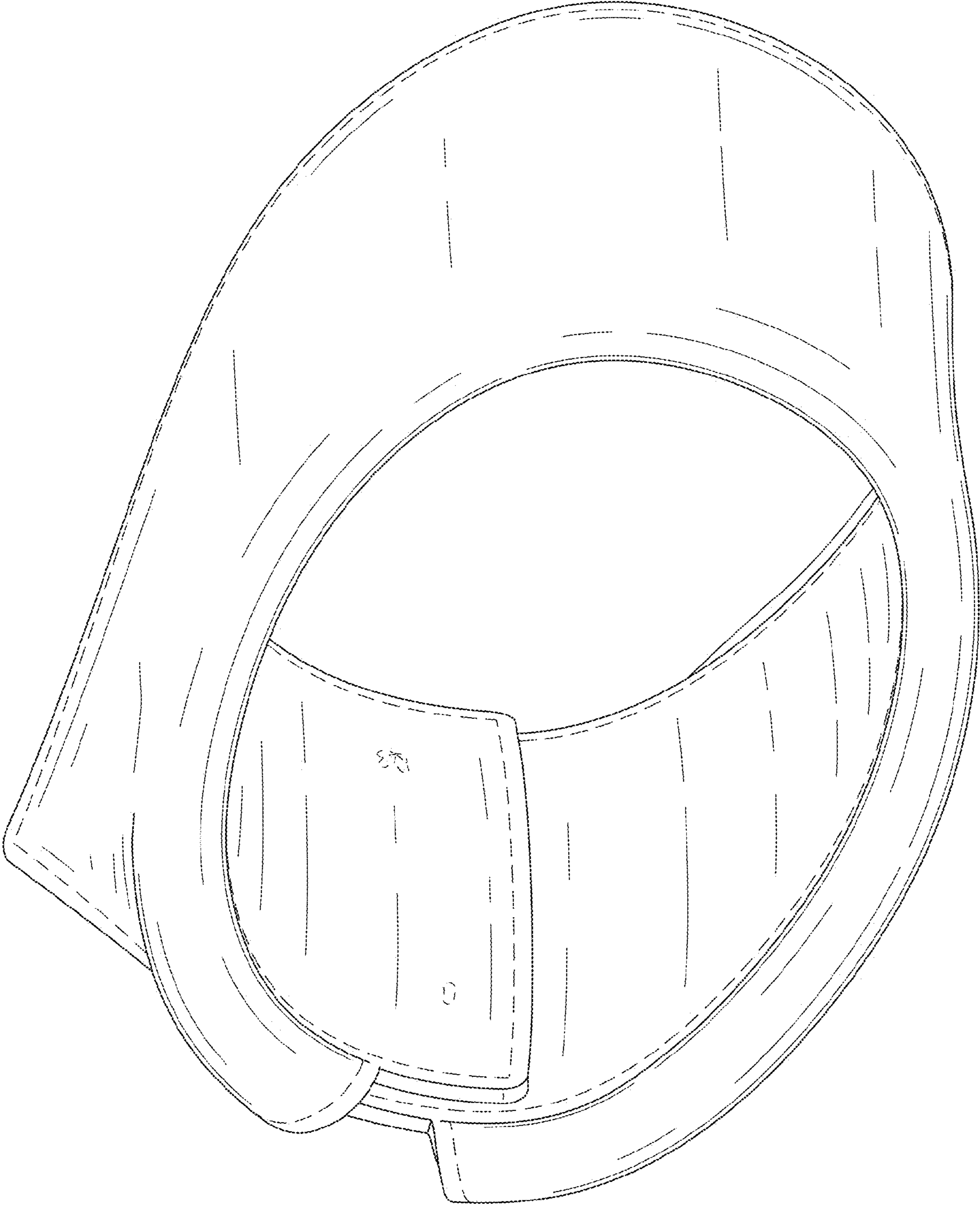

FIG. 10

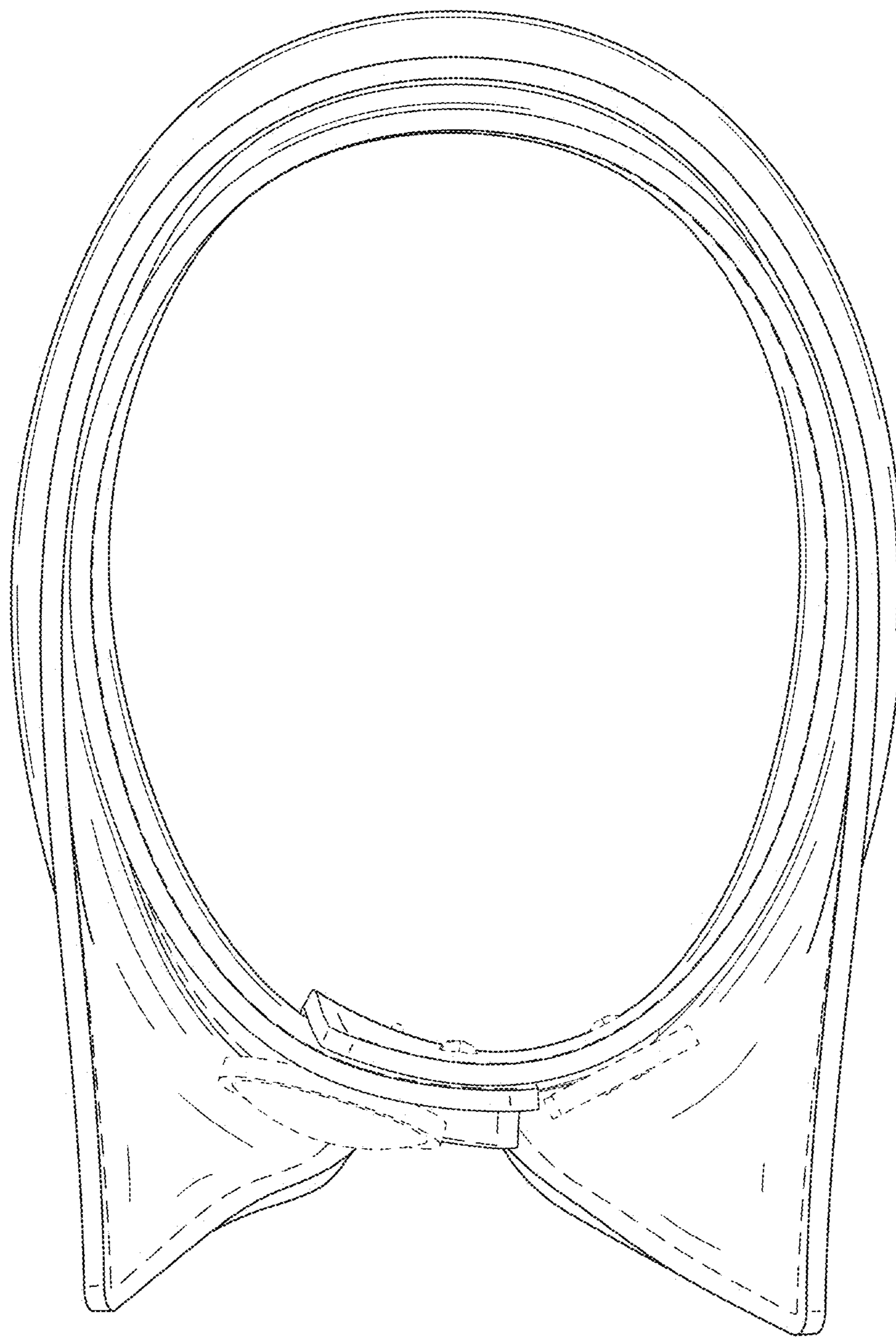

FIG. 11

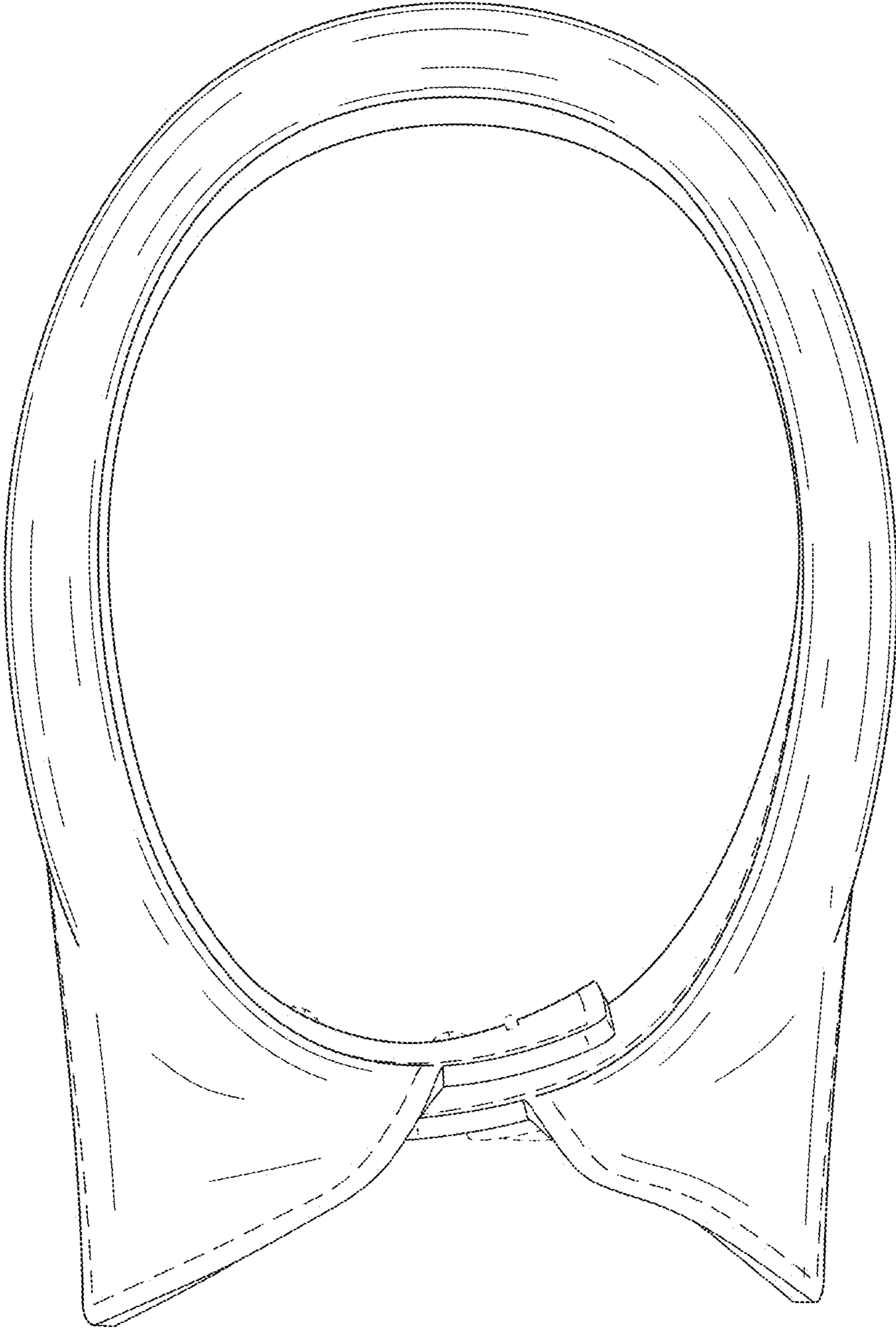

FIG. 12

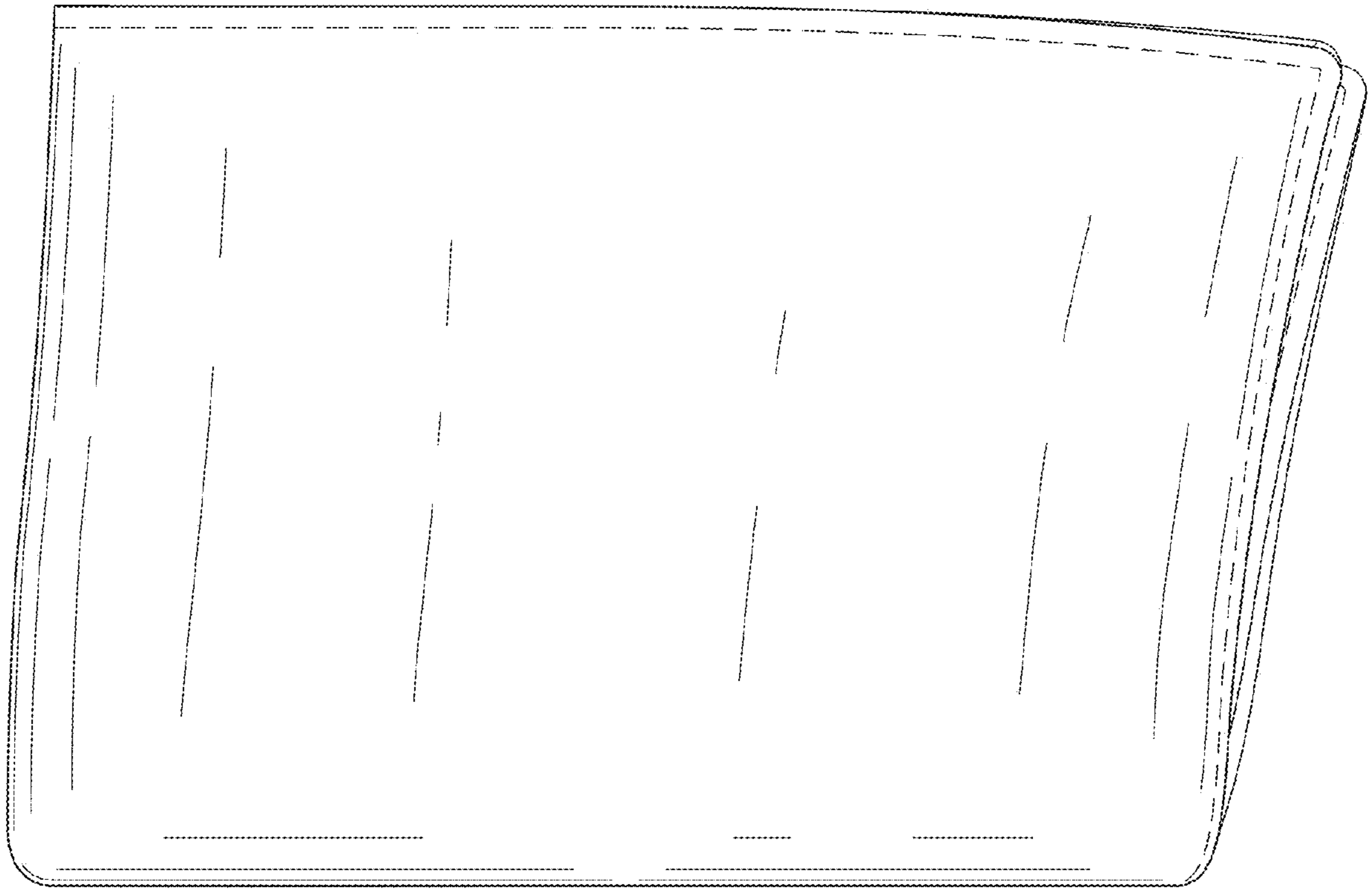

FIG. 13

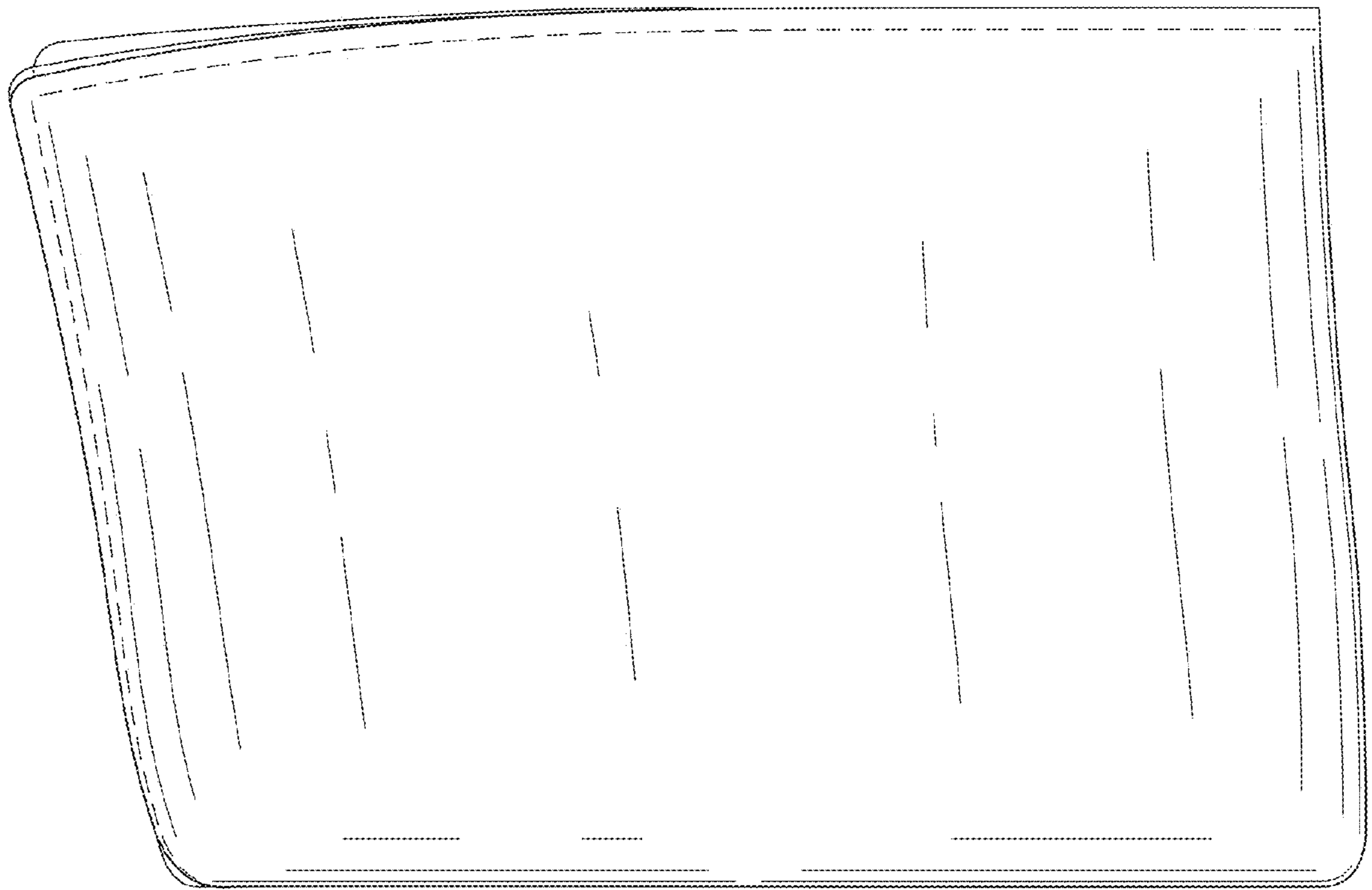

FIG. 14

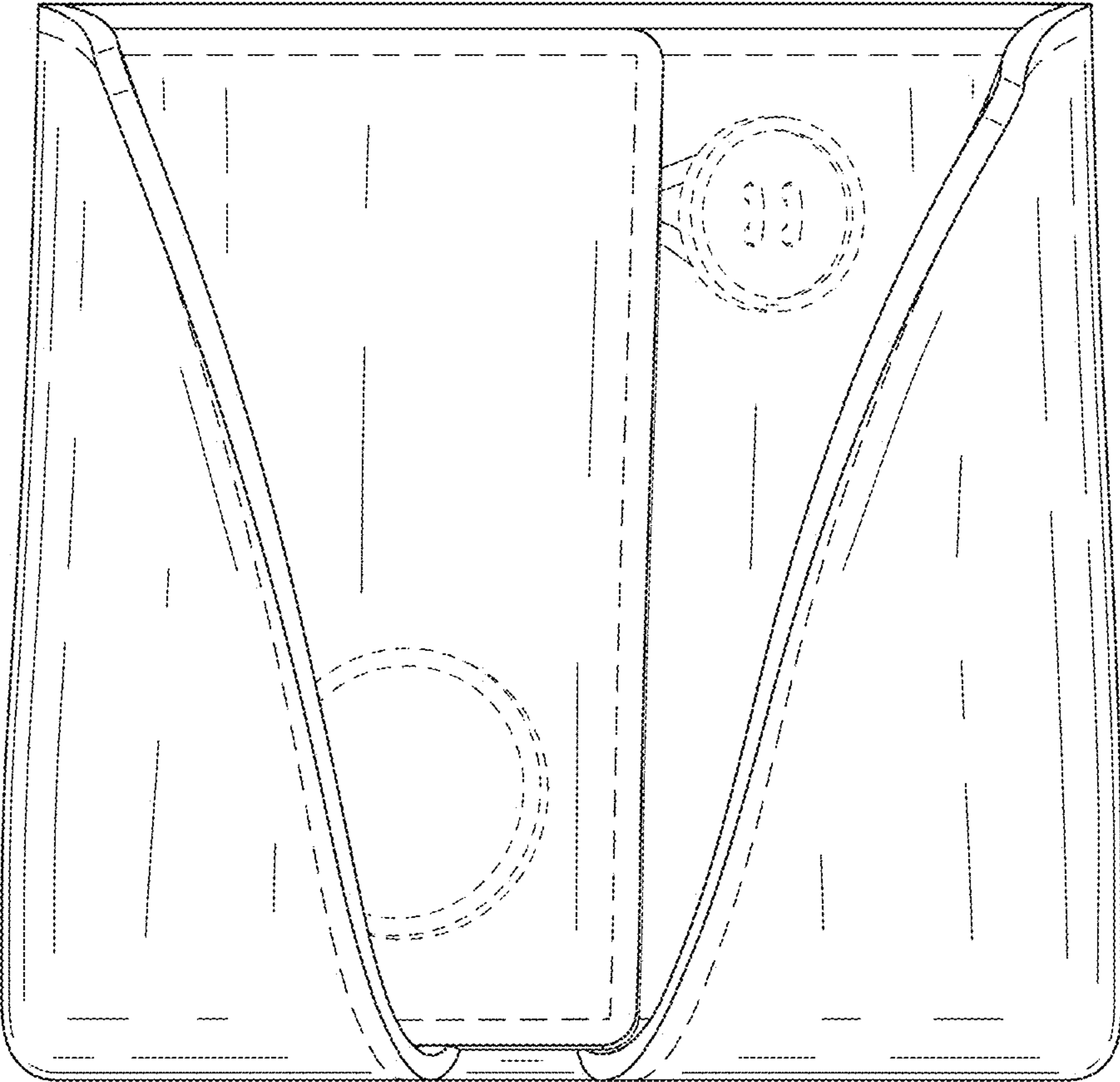

FIG. 15

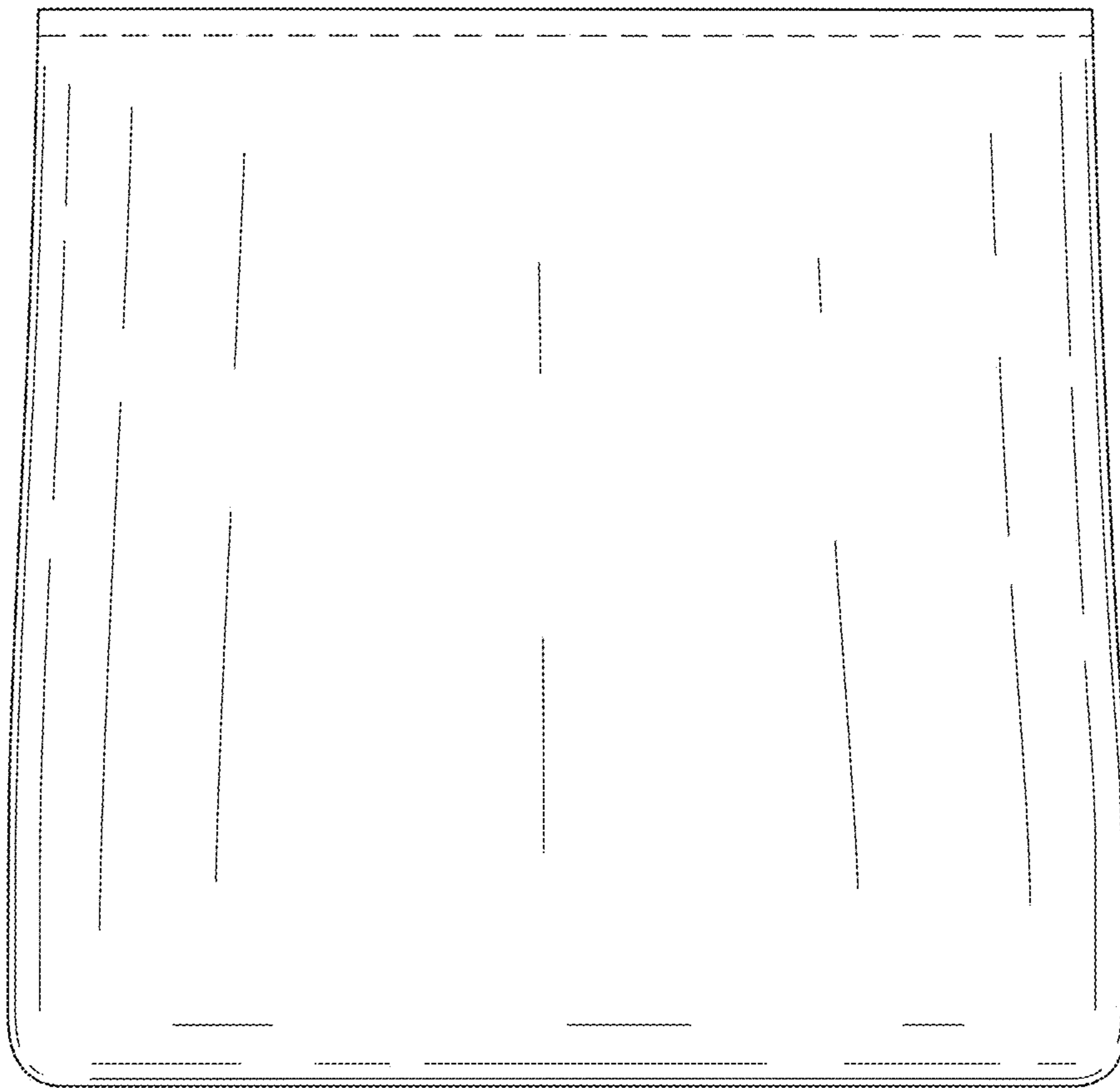

FIG. 16