



US00D956370S

(12) **United States Design Patent**  
**Toolan et al.**

(10) **Patent No.:** **US D956,370 S**  
(45) **Date of Patent:** **\*\* Jun. 28, 2022**

(54) **PET CHEW TOY**  
(71) Applicant: **Benebone LLC**, Westport, CT (US)  
(72) Inventors: **Peter Toolan**, Westport, CT (US); **Evan L. Ryan**, Highland Park, IL (US)  
(73) Assignee: **Benebone LLC**, Westport, CT (US)  
(\*\*) Term: **15 Years**

D607,618 S 1/2010 Rutherford  
D636,540 S 4/2011 McCann  
D650,536 S 12/2011 Oblack et al.  
D655,056 S 2/2012 Blair  
D658,348 S 5/2012 McCleary  
D690,897 S 10/2013 Toolan et al.  
8,573,159 B1 11/2013 Crotty et al.  
D697,274 S 1/2014 Thorne  
D699,416 S 2/2014 Bamvos et al.  
D719,707 S 12/2014 Axelrod et al.  
9,060,528 B2 6/2015 Axelrod  
D760,964 S 7/2016 Toolan

(Continued)

(21) Appl. No.: **29/745,995**

(22) Filed: **Aug. 11, 2020**

(51) **LOC (13) Cl.** ..... **30-99**

(52) **U.S. Cl.**  
USPC ..... **D30/160**

(58) **Field of Classification Search**  
USPC ..... D30/160, 112, 119; D21/386, 398, 484,  
D21/707, 712, 713; D24/193, 194, 195,  
D24/211, 212, 214; D1/125, 126, 127  
CPC ..... A01K 15/025; A01K 15/026  
See application file for complete search history.

(56) **References Cited**

**U.S. PATENT DOCUMENTS**

D433,778 S \* 11/2000 Axelrod ..... D30/160  
6,360,693 B1 3/2002 Long, III  
6,379,725 B1 \* 4/2002 Wang ..... A23J 3/26  
426/805  
D461,025 S 7/2002 Pentland et al.  
D501,286 S 2/2005 Wang  
D501,698 S 2/2005 McNamara  
D501,699 S 2/2005 McNamara  
D511,030 S \* 10/2005 Byrne ..... D30/160  
D512,189 S \* 11/2005 Byrne ..... D30/160  
D534,694 S \* 1/2007 Pozzoni ..... D30/160  
D542,506 S 5/2007 Springer  
D553,809 S 10/2007 Gick  
D576,357 S \* 9/2008 Rutherford ..... D30/160  
D578,714 S \* 10/2008 Rutherford ..... D30/160  
D578,726 S 10/2008 Edwards

**OTHER PUBLICATIONS**

Pet Qwerks, Inc., 2018 Product Catalog, downloaded on Apr. 16, 2019 from <http://petqwerks.com/> from Internet Archive WAYBACKMACHINE dated May 31, 2018; <https://web.archive.org/web/20180531031326/https://petqwerks.com/>.

(Continued)

*Primary Examiner* — Sheryl Lane  
*Assistant Examiner* — Aula Soroush  
(74) *Attorney, Agent, or Firm* — Fred Zollinger

(57) **CLAIM**

The ornamental design for a pet chew toy, as shown and described.

**DESCRIPTION**

FIG. 1 is a front perspective view of a pet chew toy showing our new design;  
FIG. 2 is a rear perspective view thereof.  
FIG. 3 is a front elevation view of thereof.  
FIG. 4 is a top plan view thereof.  
FIG. 5 is a rear elevation view thereof.  
FIG. 6 is a bottom plan view thereof.  
FIG. 7 is a right side elevation view thereof; and,  
FIG. 8 is a left side elevation view thereof.

**1 Claim, 5 Drawing Sheets**

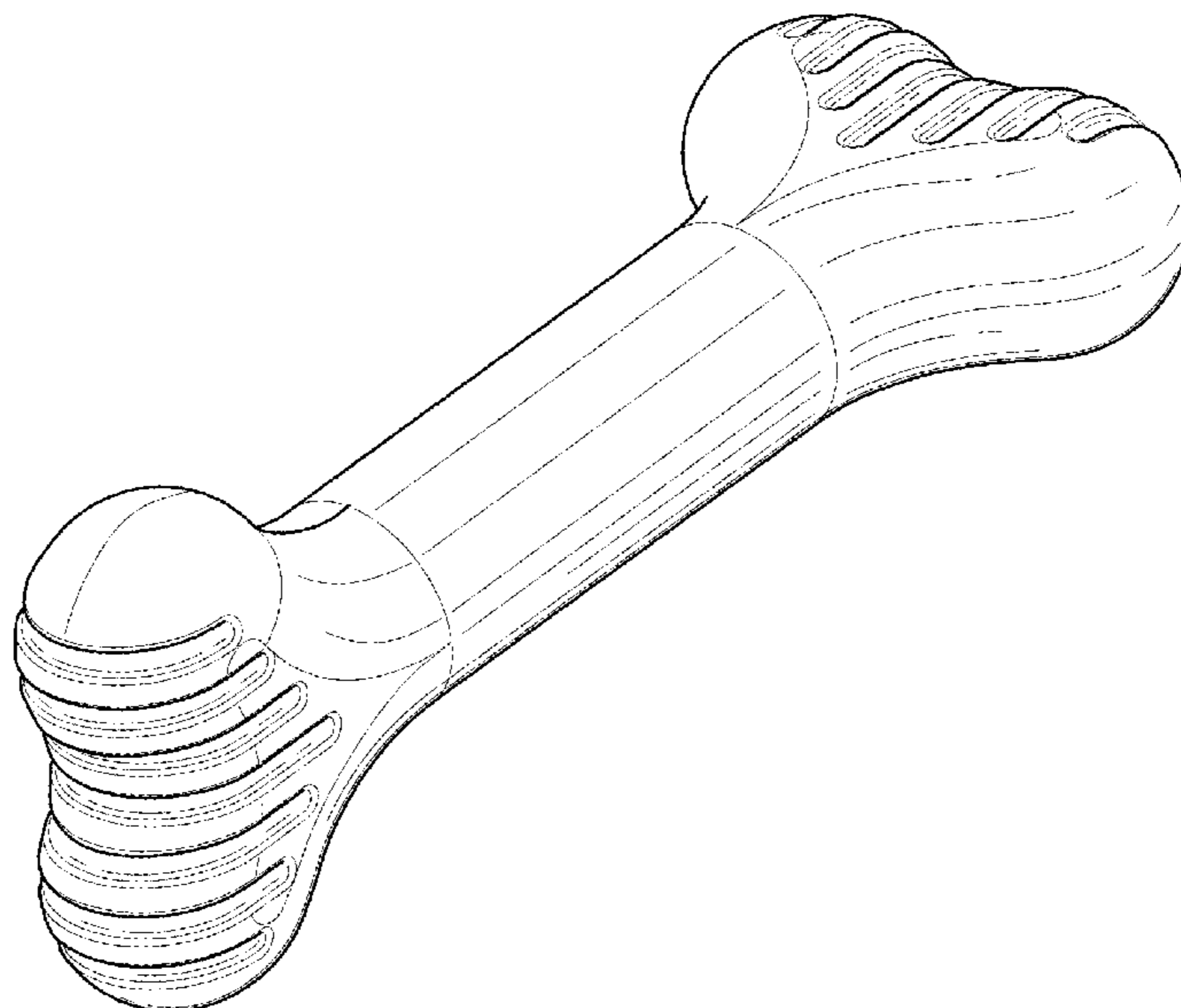

(56)

References Cited

U.S. PATENT DOCUMENTS

9,585,368 B2 3/2017 Gick  
D787,775 S 5/2017 Peterson  
D811,018 S 2/2018 Toolan  
D818,214 S 5/2018 Toolan et al.  
D819,279 S 5/2018 Gick  
D819,899 S 6/2018 Gick  
D840,610 S 2/2019 Toolan et al.  
D841,903 S 2/2019 Toolan  
D858,907 S 9/2019 Gick  
D869,786 S 12/2019 Gick  
D870,400 S 12/2019 Toolan et al.  
D871,686 S 12/2019 Toolan et al.  
D872,385 S \* 1/2020 Soto ..... D30/160  
D877,427 S \* 3/2020 Wolfe, Jr. .... D30/160  
D877,428 S \* 3/2020 Wolfe, Jr. .... D30/160  
D877,992 S 3/2020 Gick  
D884,296 S 5/2020 Gick  
D894,503 S \* 8/2020 Toolan ..... D30/160  
D899,014 S \* 10/2020 Wolfe, Jr. .... D30/160  
D901,104 S \* 11/2020 Dertsakyan ..... D30/160  
D905,355 S \* 12/2020 Wang ..... D30/160  
D911,634 S \* 2/2021 Wolfe, Jr. .... D30/160  
D911,635 S \* 2/2021 Dertsakyan ..... D30/160  
D915,005 S \* 3/2021 Wolfe, Jr. .... D30/160  
D929,677 S \* 8/2021 Toolan ..... D30/160  
D930,287 S \* 9/2021 Toolan ..... D30/160  
D932,114 S \* 9/2021 Toolan ..... D30/160  
D938,665 S \* 12/2021 Wu ..... D30/160  
2006/0102099 A1 5/2006 Edwards

2011/0232581 A1 9/2011 Gick  
2016/0165845 A1 6/2016 Stone  
2017/0303510 A1 10/2017 Stone et al.

OTHER PUBLICATIONS

Drawings from Design U.S. Appl. No. 29/622,395, filed Oct. 17, 2017.  
Nylabone Dura Chew Axis Bone Dog Chew, reviewed on Amazon.com Aug. 15, 2014.  
Pet Dog Puppy Play Chew Toy Natural Rubber Bone with Bumps by TRIXIE, accessed on Ebay.com on Oct. 26, 2017, updated Sep. 27, 2017.  
Pet Qwerks, Inc., 2017 Product Catalog, downloaded on Apr. 16, 2019 from <http://petqwerks.com/> from Internet Archive WAYBACKMACHINE dated Mar. 15, 2017; <https://web.archive.org/web/20170315060052/http://petqwerks.com/>.  
Pet Qwerks, Inc., 2016 Product Catalog, downloaded on Apr. 16, 2019 from <http://petqwerks.com/> from Internet Archive WAYBACKMACHINE dated Oct. 6, 2016; <https://web.archive.org/web/20161006135153/http://petqwerks.com/>.  
Pet Qwerks Toys, BarkBone Breath Chew Stick with Mint Flavor Dog Chew Toy for Aggressive Chewers, accessed from <https://petqwerks.com/product/barkbone-breath-chew-stick-with-mint-flavor-dog-chew-toy-made-in-usa/> Apr. 23, 2019.  
Pet Qwerks Toys, BarkBone Breath Chew Stick with Peanut Butter Flavor Dog Chew Toy for Aggressive Chewers, accessed from <https://petqwerks.com/product/barkbone-stick-peanut-butter-flavor-dog-chew-toy-made-in-usa/> Apr. 23, 2019.

\* cited by examiner

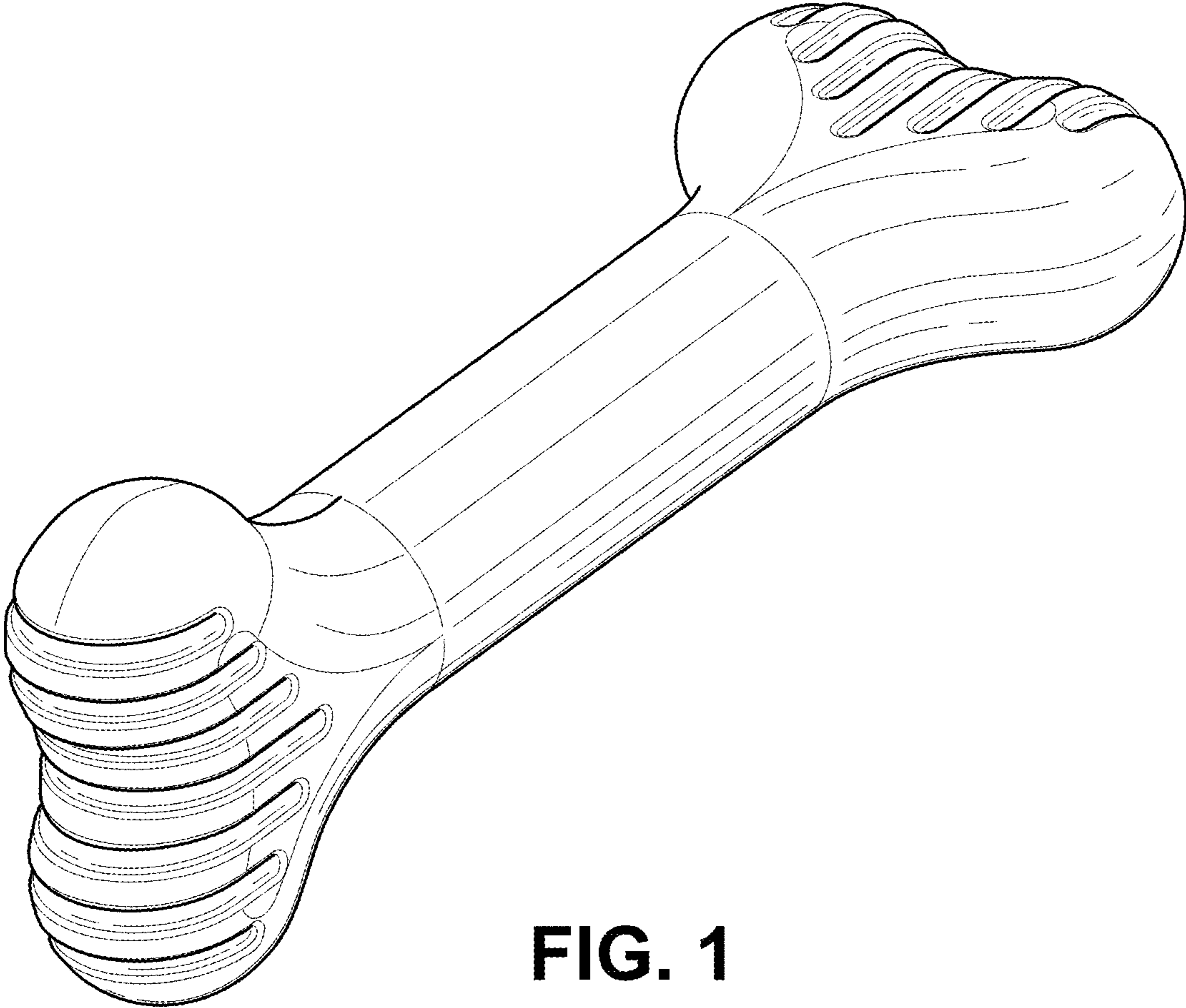

**FIG. 1**

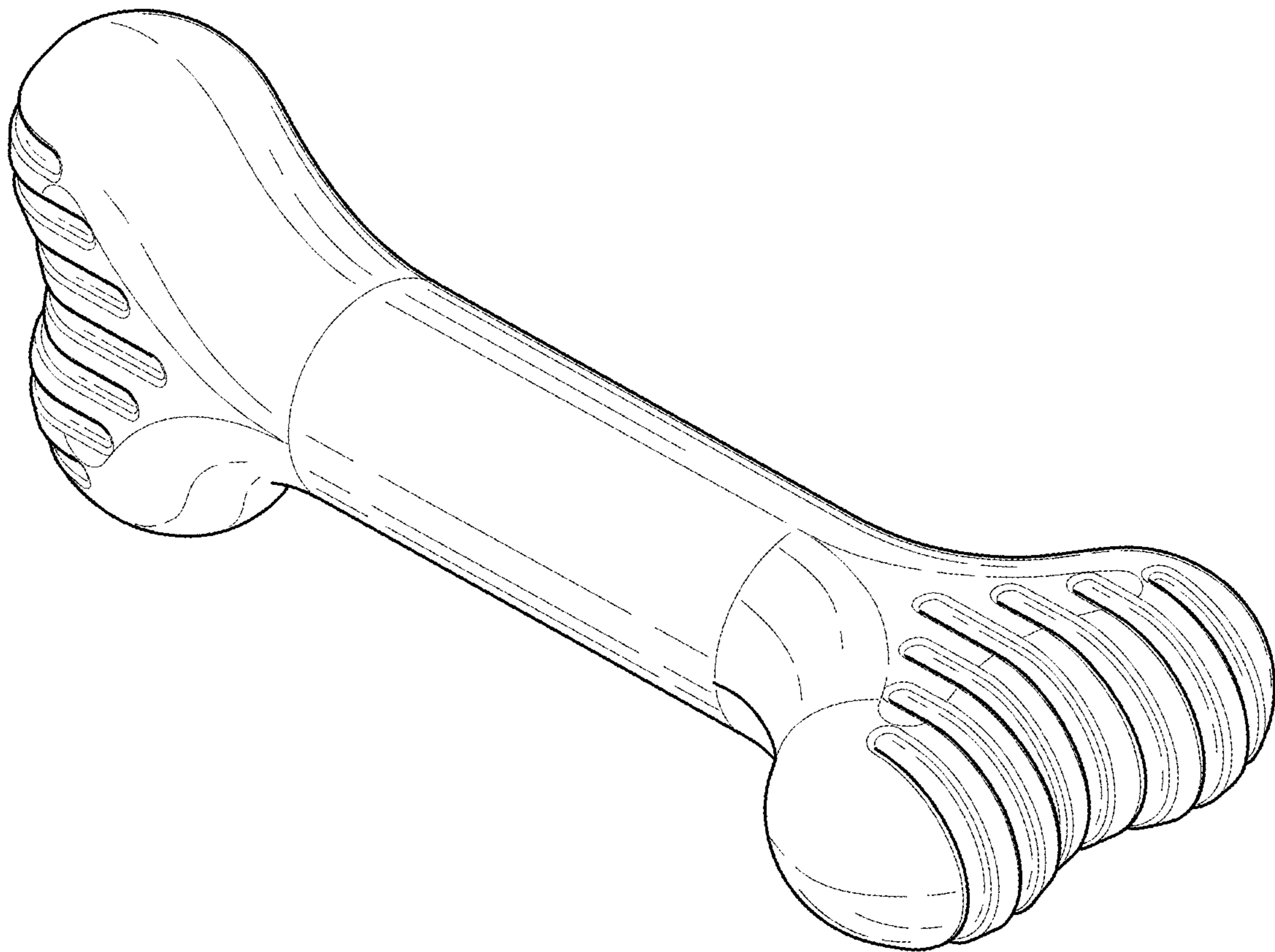

**FIG. 2**

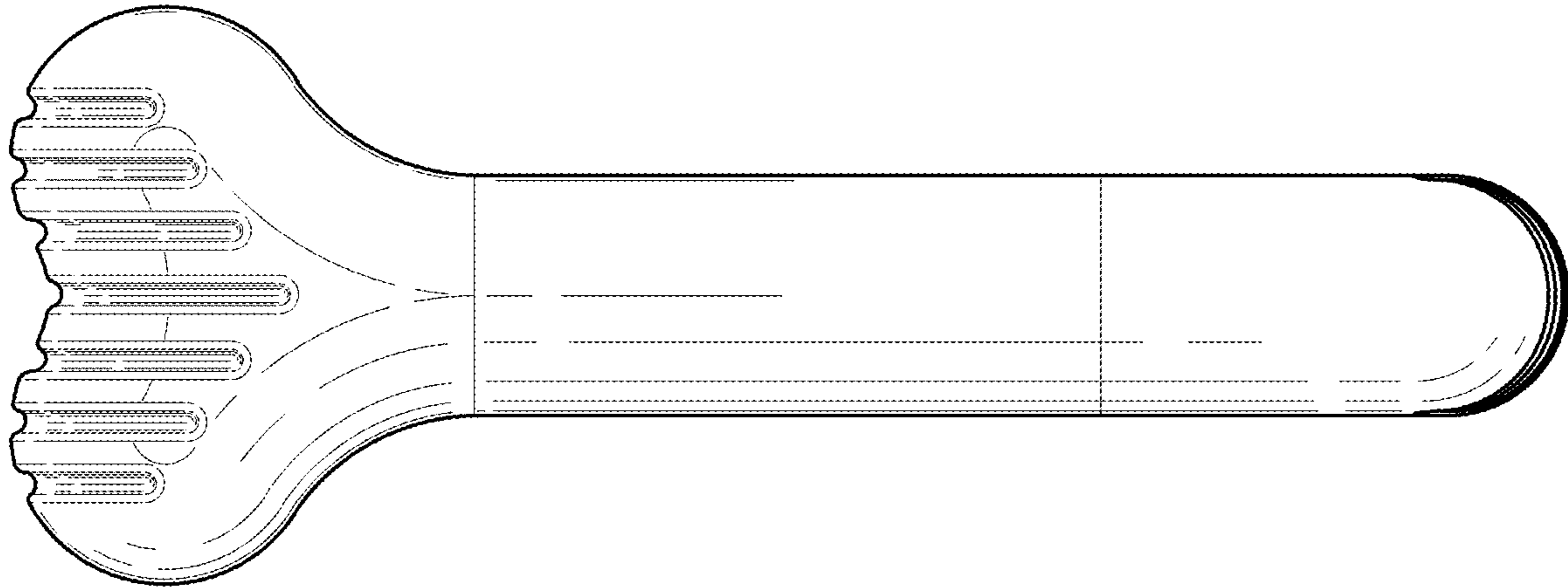

**FIG. 3**

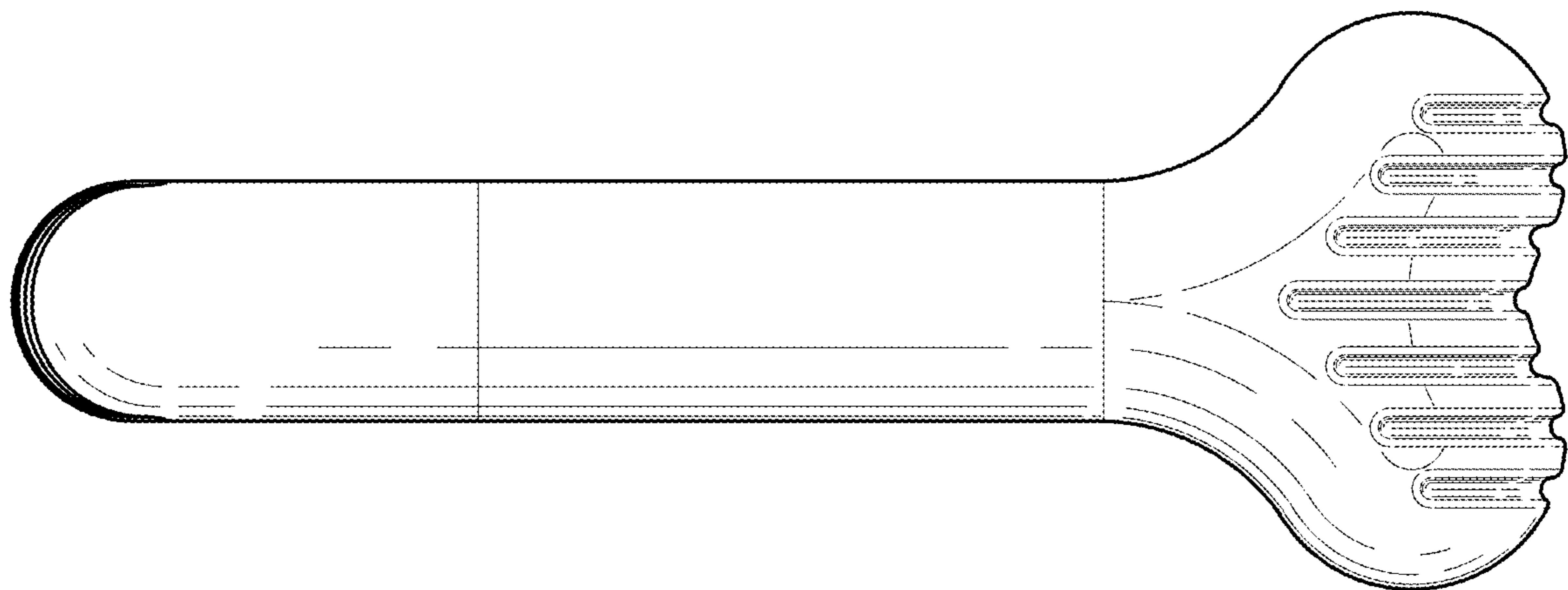

**FIG. 4**

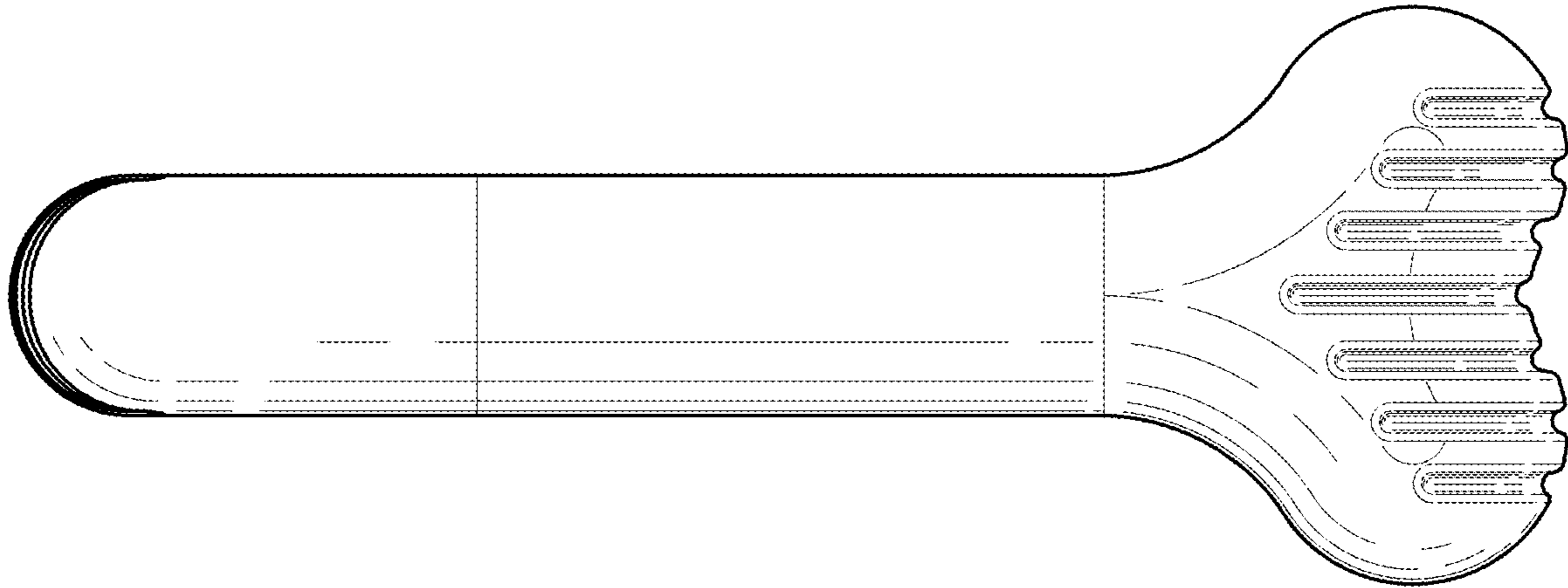

**FIG. 5**

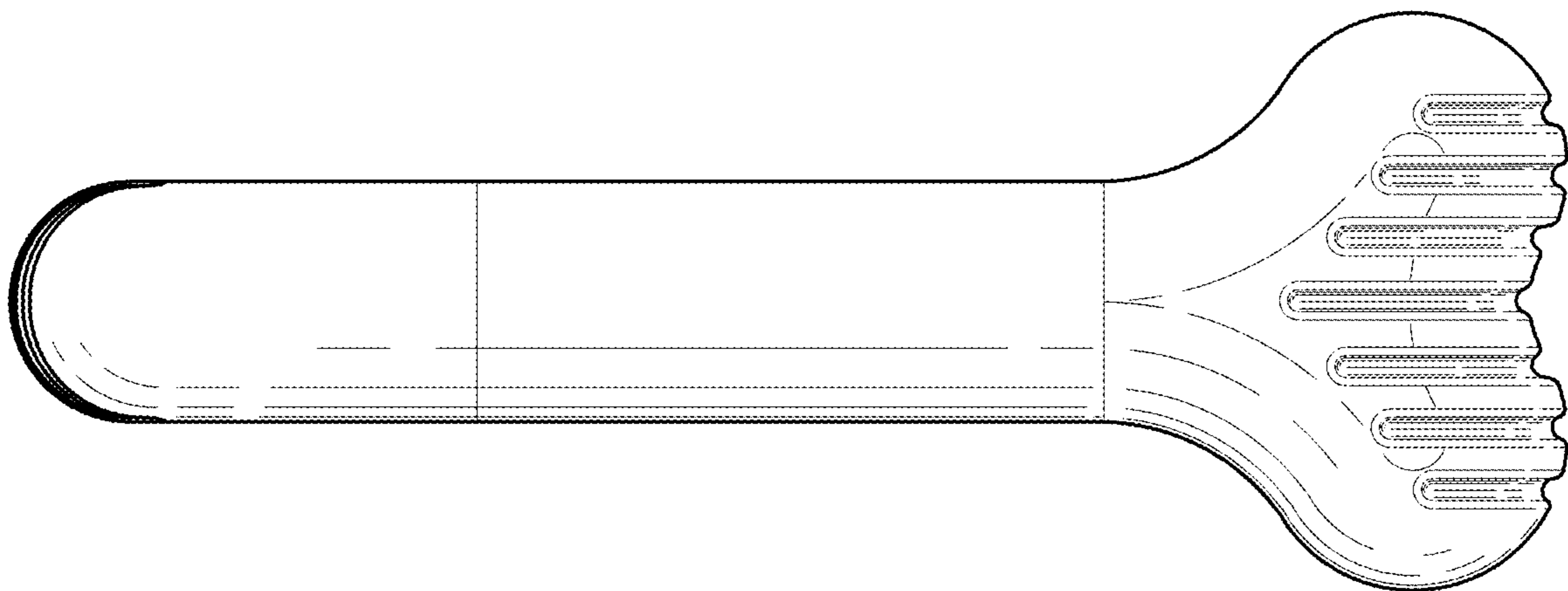

**FIG. 6**

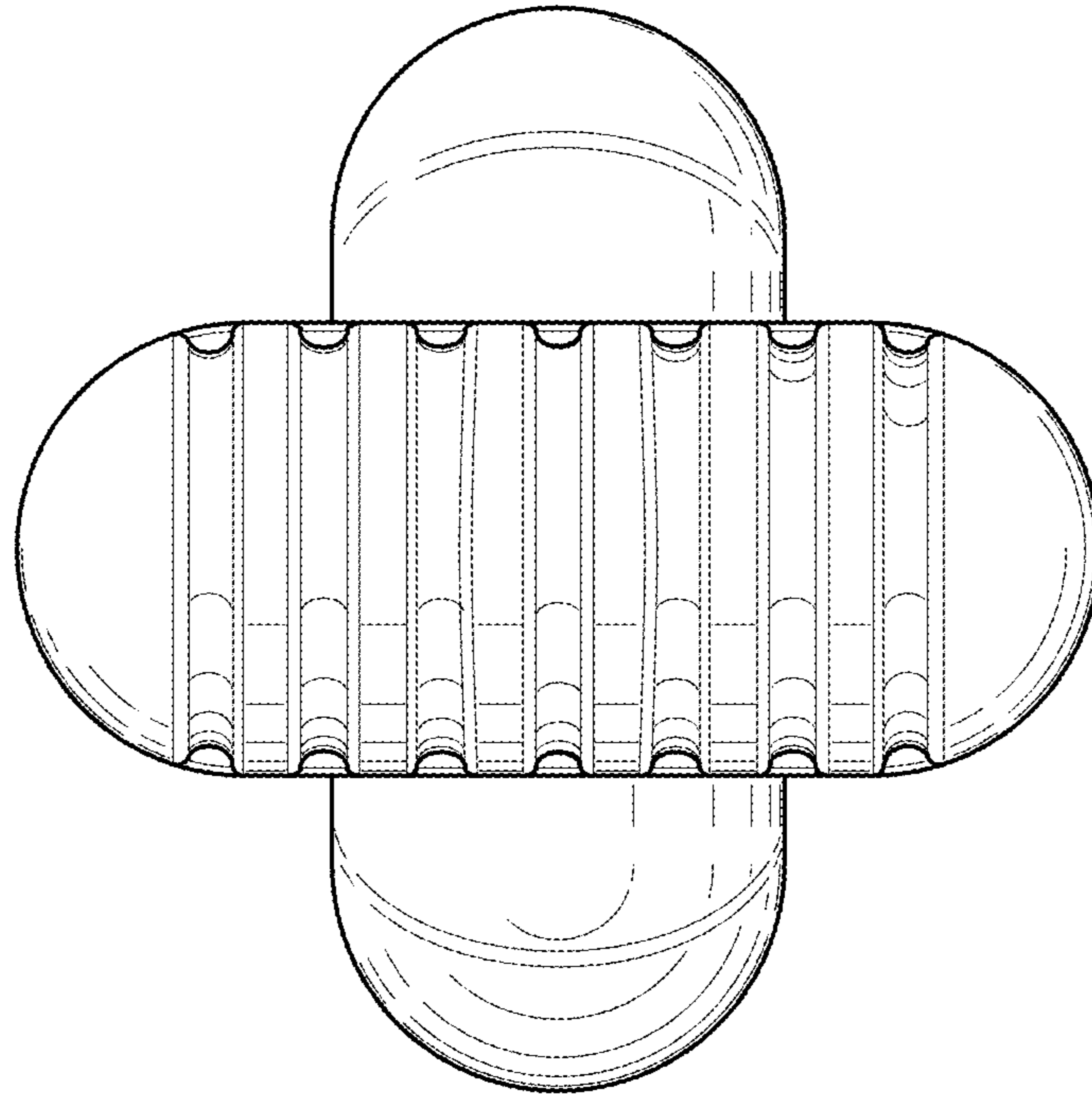

**FIG. 7**

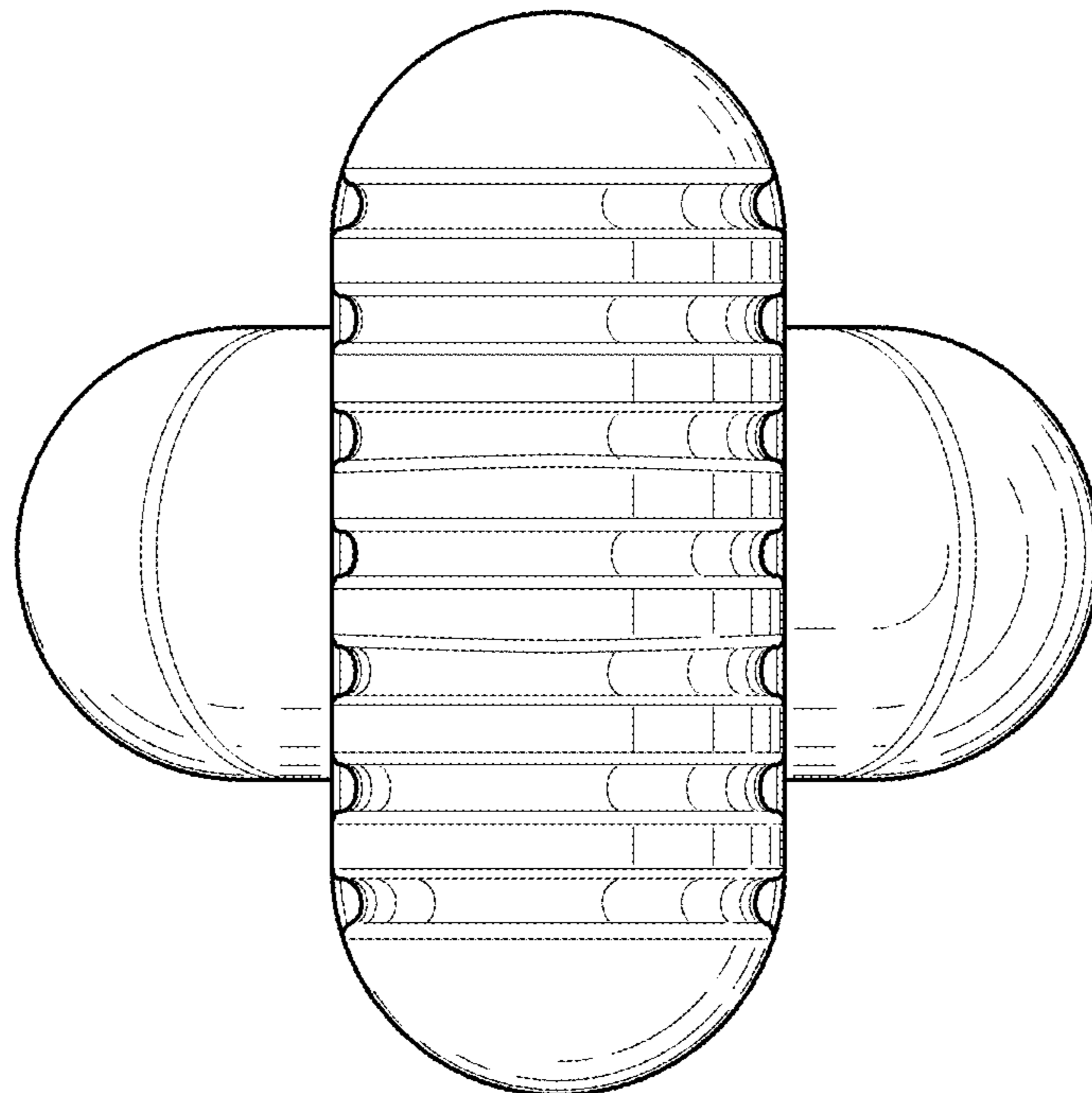

**FIG. 8**