



US00D956288S

(12) **United States Design Patent**
He

(10) **Patent No.:** **US D956,288 S**
(45) **Date of Patent:** **** Jun. 28, 2022**

- (54) **TRUCK HEADLIGHT**
- (71) Applicant: **HAICHEN AUTO PARTS CO., LTD.,**
Zhejiang (CN)
- (72) Inventor: **Qiyu He,** Zhejiang (CN)
- (73) Assignee: **HAICHEN AUTO PARTS CO., LTD.,**
Zhejiang (CN)
- (**) Term: **15 Years**
- (21) Appl. No.: **29/755,564**
- (22) Filed: **Oct. 21, 2020**
- (51) **LOC (13) Cl.** **26-06**
- (52) **U.S. Cl.**
USPC **D26/28**
- (58) **Field of Classification Search**
USPC D26/28-36, 139
CPC F21S 48/00; F21S 48/10; F21S 48/115;
F21S 48/225; F21S 48/1233; F21S
48/1266; F21S 48/1388; F21S 48/2268;
F21V 5/00; F21V 21/04; F21V 29/004;
B60Q 9/13; B60Q 9/135; B60Q 9/1375;
F21W 2102/17; F21W 2103/00; F21W
2103/35; F21W 2103/55; F21W 2107/13;
F21W 2107/17
See application file for complete search history.

D905,882 S * 12/2020 Munakata D26/28
D907,260 S * 1/2021 He D26/28
D907,817 S * 1/2021 Tonello D26/28

* cited by examiner

Primary Examiner — Marcus A Jackson
(74) *Attorney, Agent, or Firm* — Muncy, Geissler, Olds &
Lowe, P.C.

(57) **CLAIM**

The ornamental design for a truck headlight, as shown and described.

DESCRIPTION

FIG. 1 is a front, right perspective view of a truck headlight showing my new design, with the front panel shown separately from the rear panel;
FIG. 2 is a front, right perspective view thereof, of the rear panel only;
FIG. 3 is a front, right perspective view thereof, of the front and rear panels together;
FIG. 4 is a front elevational view thereof, of the front and rear panels together;
FIG. 5 is a front elevational view thereof, of the front panel only;
FIG. 6 is a front, right perspective view thereof, of the rear panel only;
FIG. 7 is a front, left perspective view thereof, of the front and rear panels together;
FIG. 8 is a rear elevational view thereof;
FIG. 9 is a left side elevational view thereof, of the front and rear panels together; and,
FIG. 10 is a top plan view thereof.
The broken lines illustrate portions of the truck headlight which form no part of the claimed design.

(56) **References Cited**

U.S. PATENT DOCUMENTS

- D691,301 S * 10/2013 Lai D26/28
- D720,870 S * 1/2015 Lim D26/28
- D842,501 S * 3/2019 Lin D26/28
- D844,196 S * 3/2019 Lin D26/28
- D851,305 S * 6/2019 Lai D26/28
- D858,812 S * 9/2019 Lin D26/28
- D905,306 S * 12/2020 Lai D26/28

1 Claim, 10 Drawing Sheets

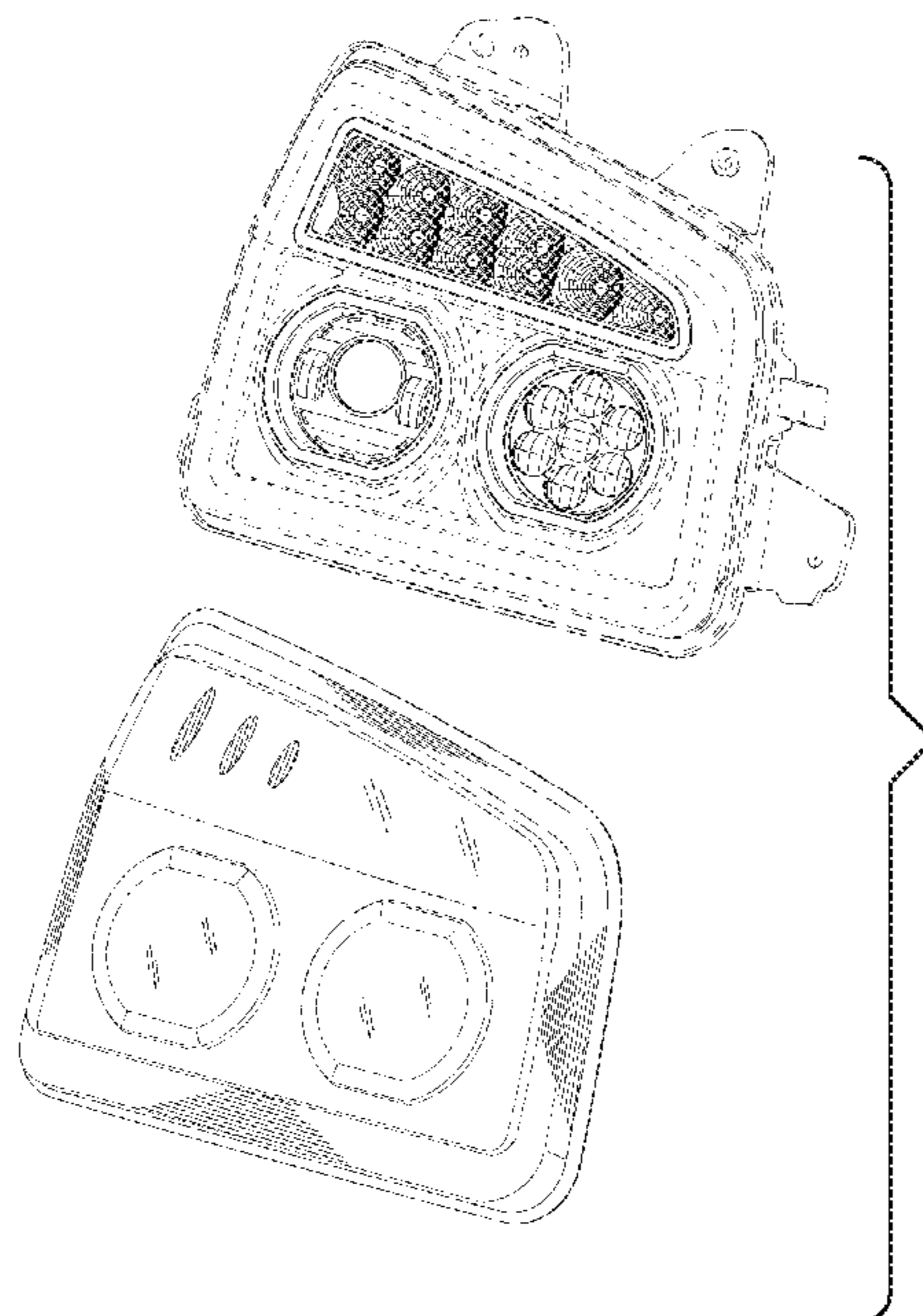

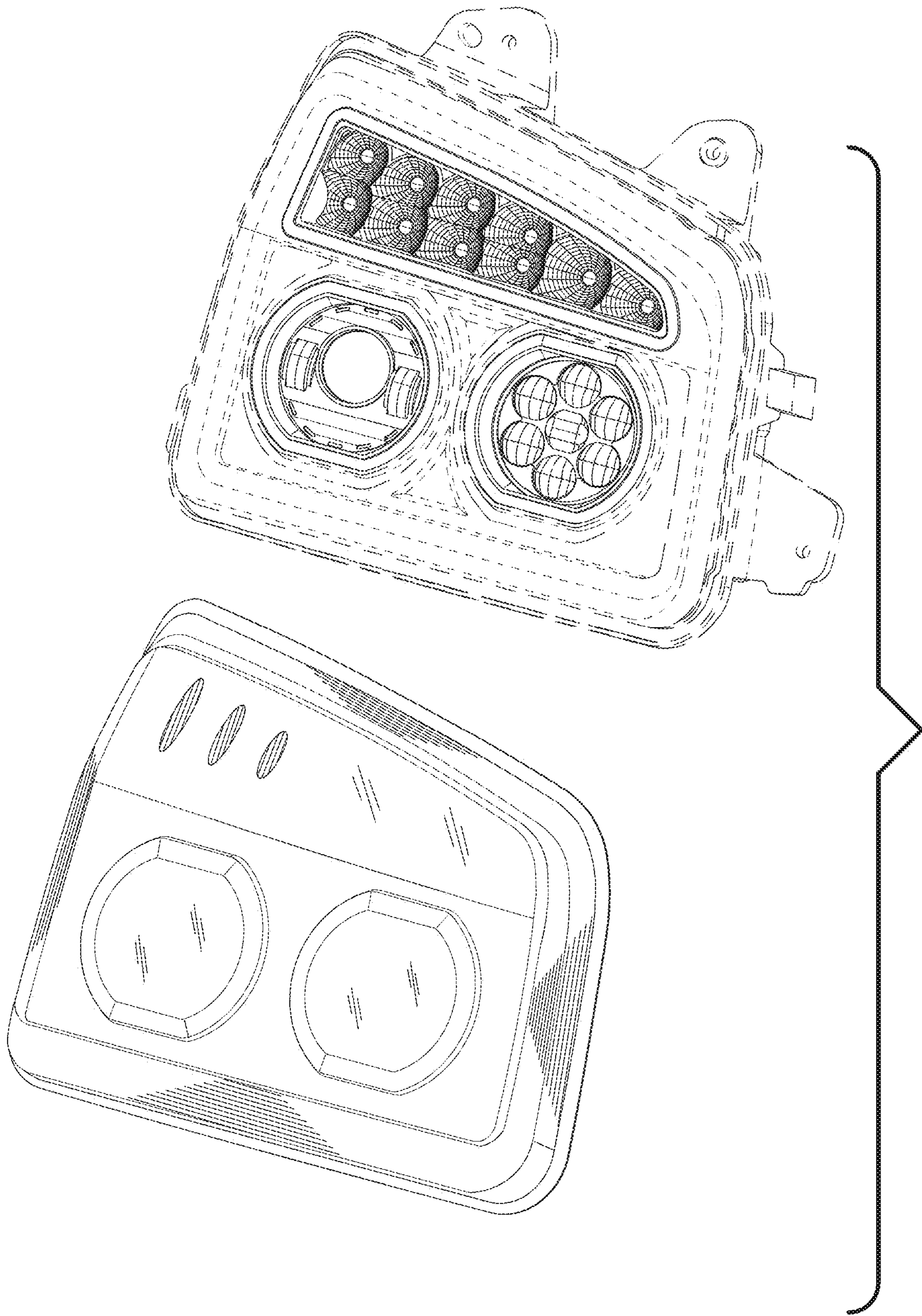

FIG.1

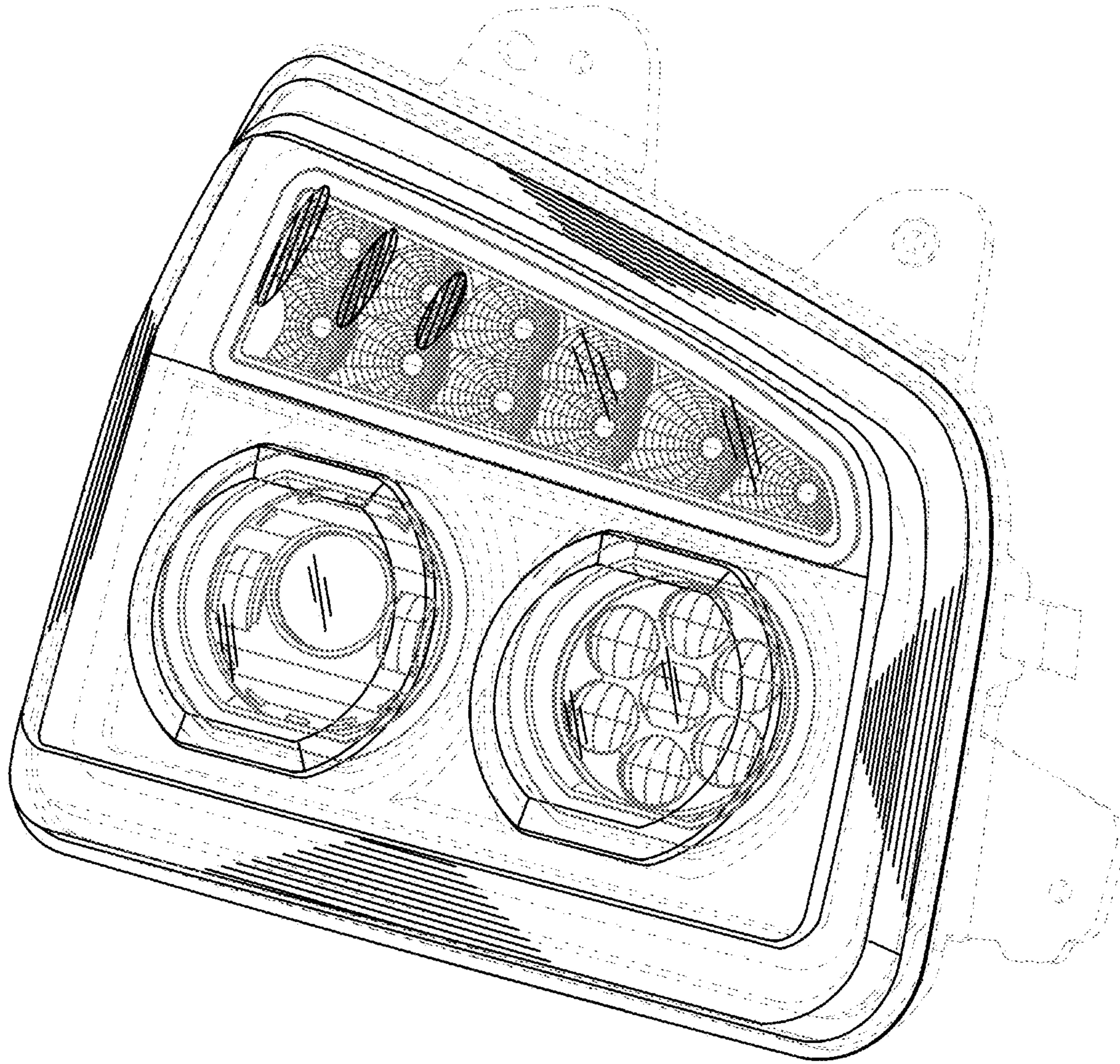

FIG. 2

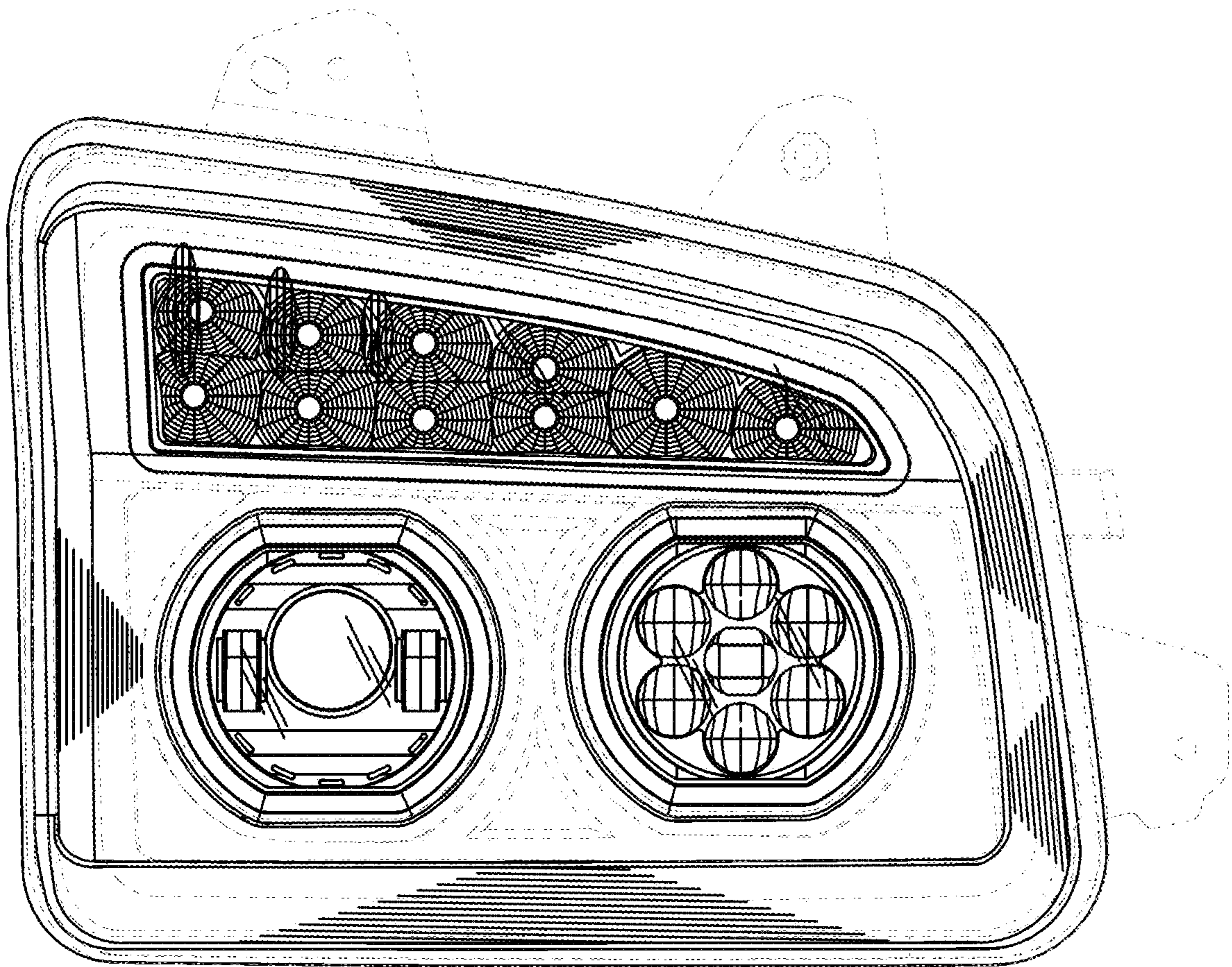

FIG.3

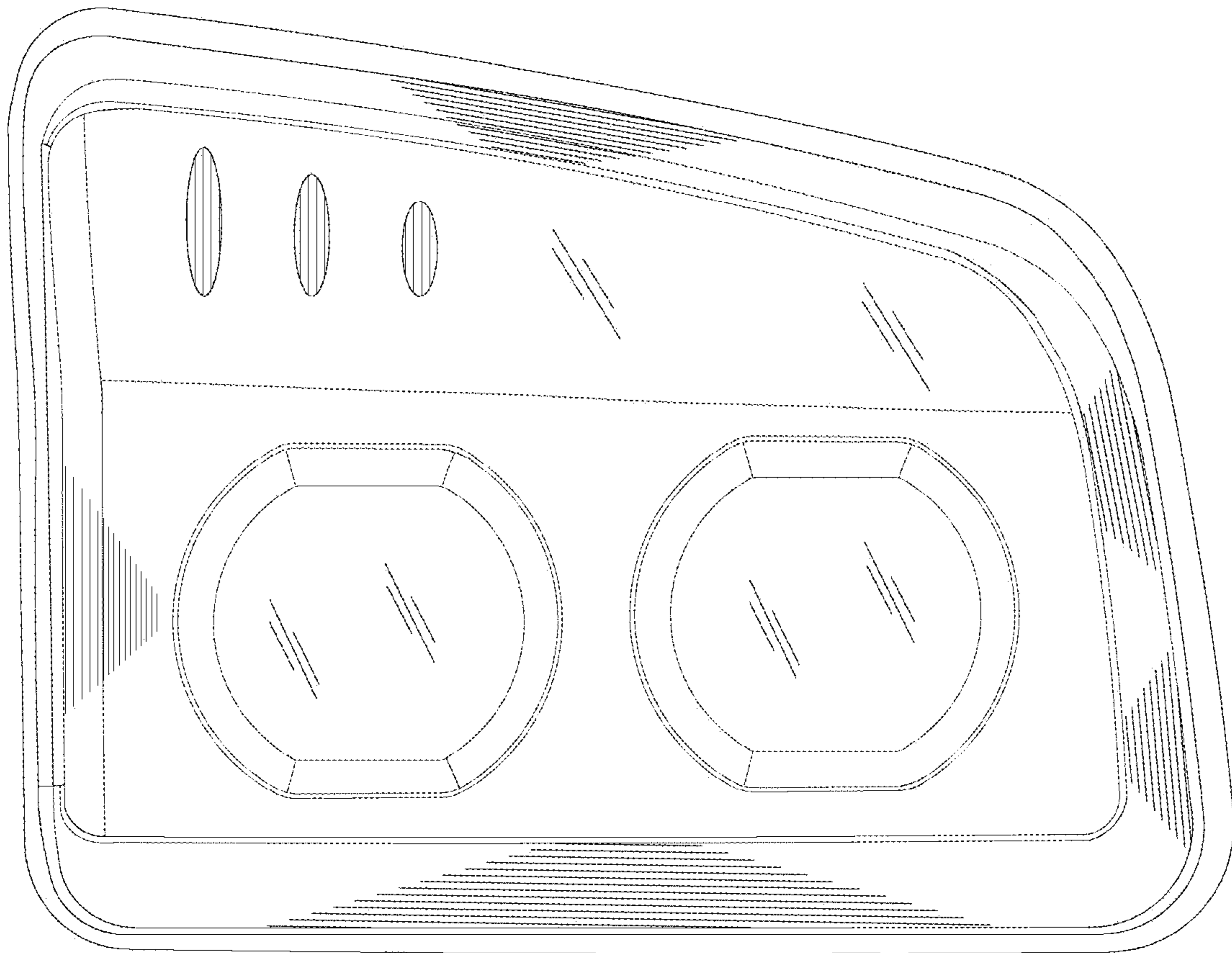

FIG.4

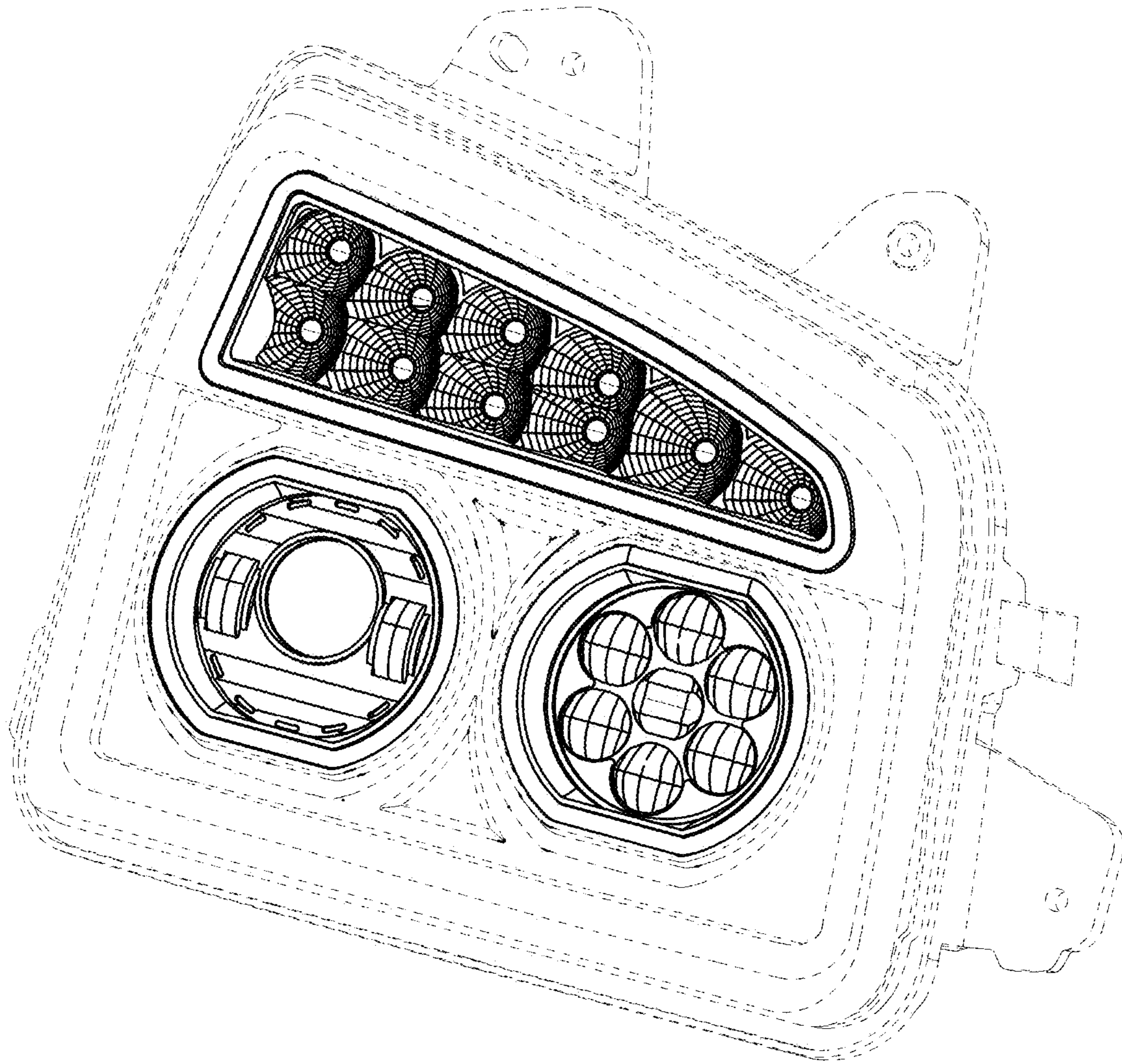

FIG.5

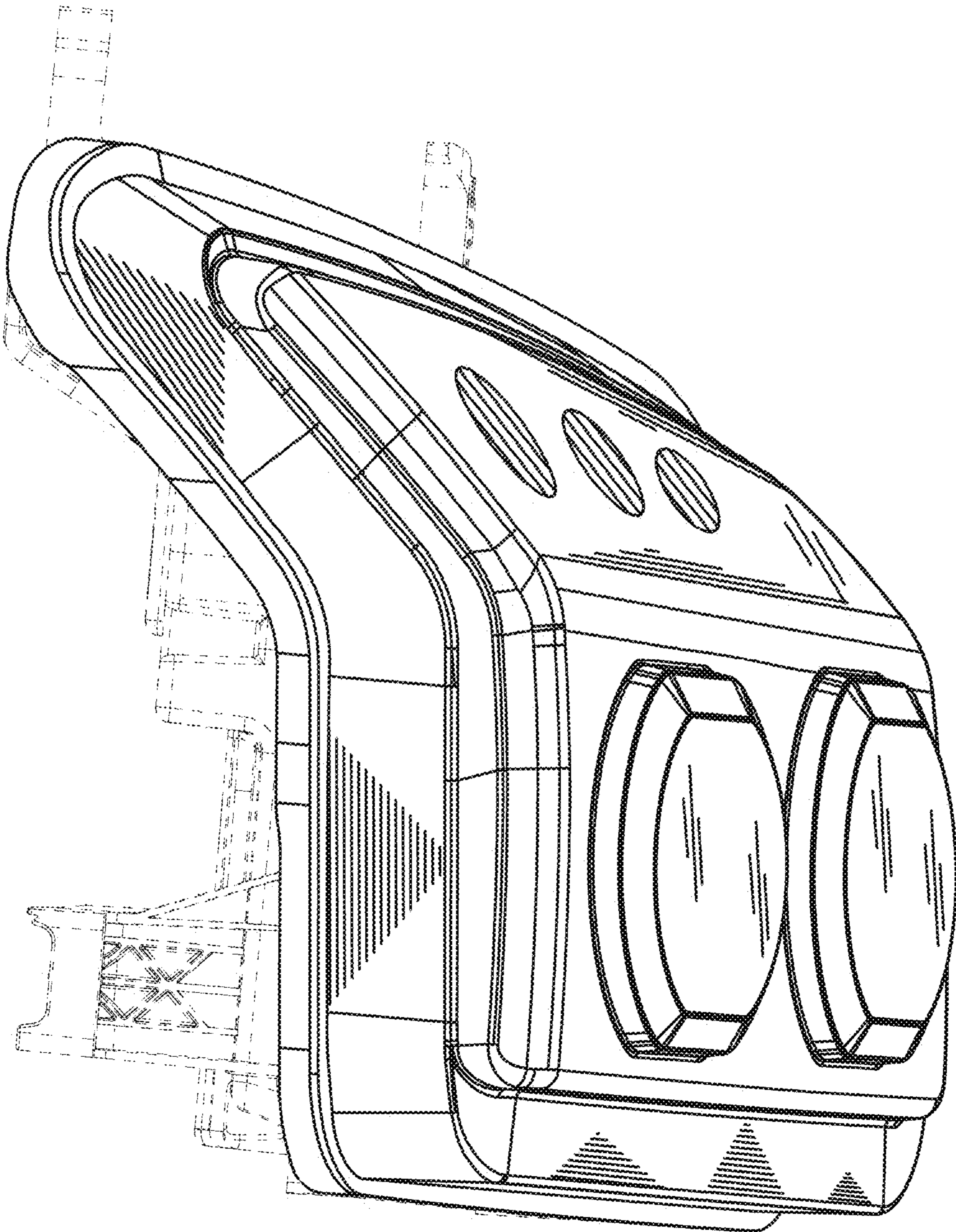

FIG.6

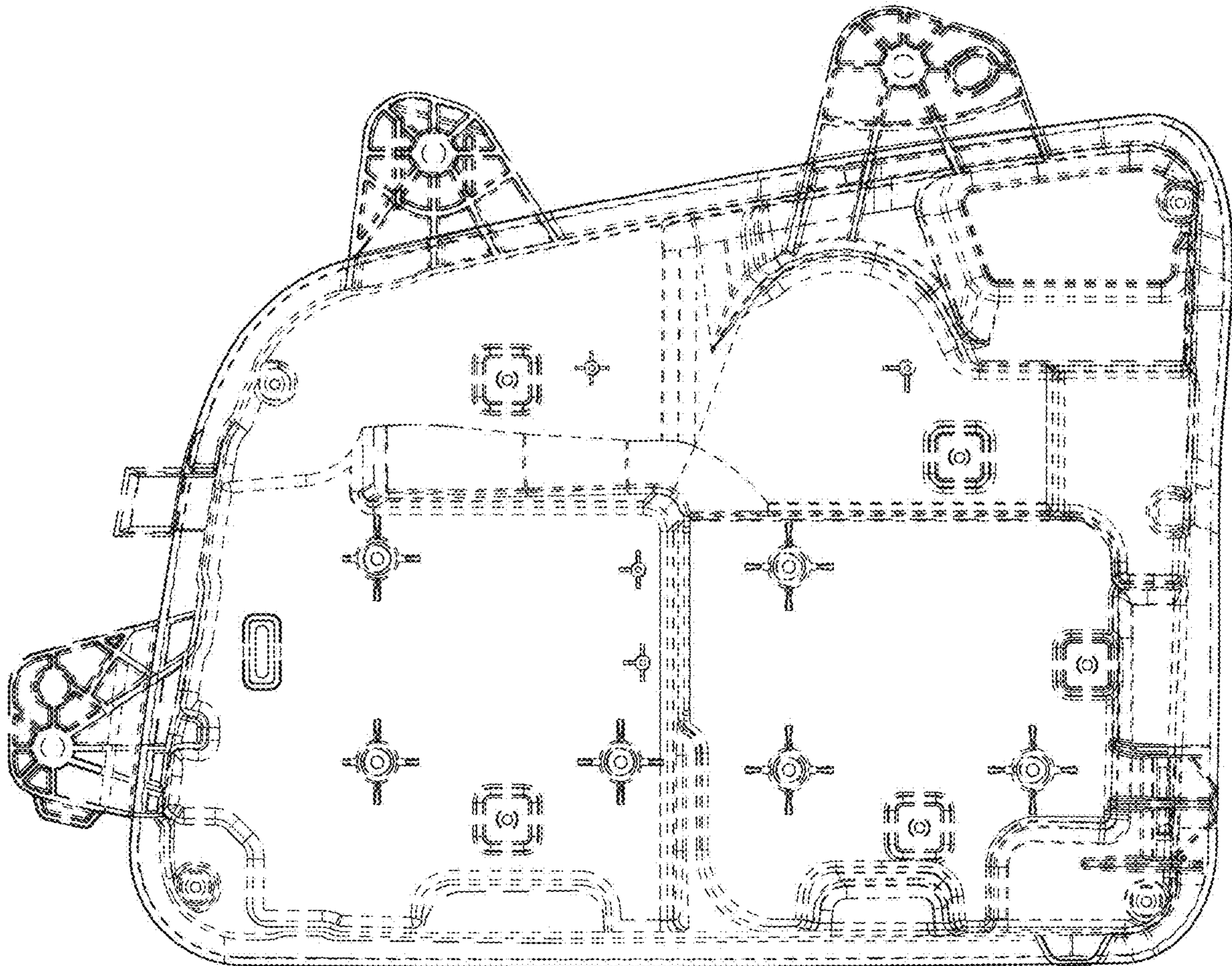

FIG. 7

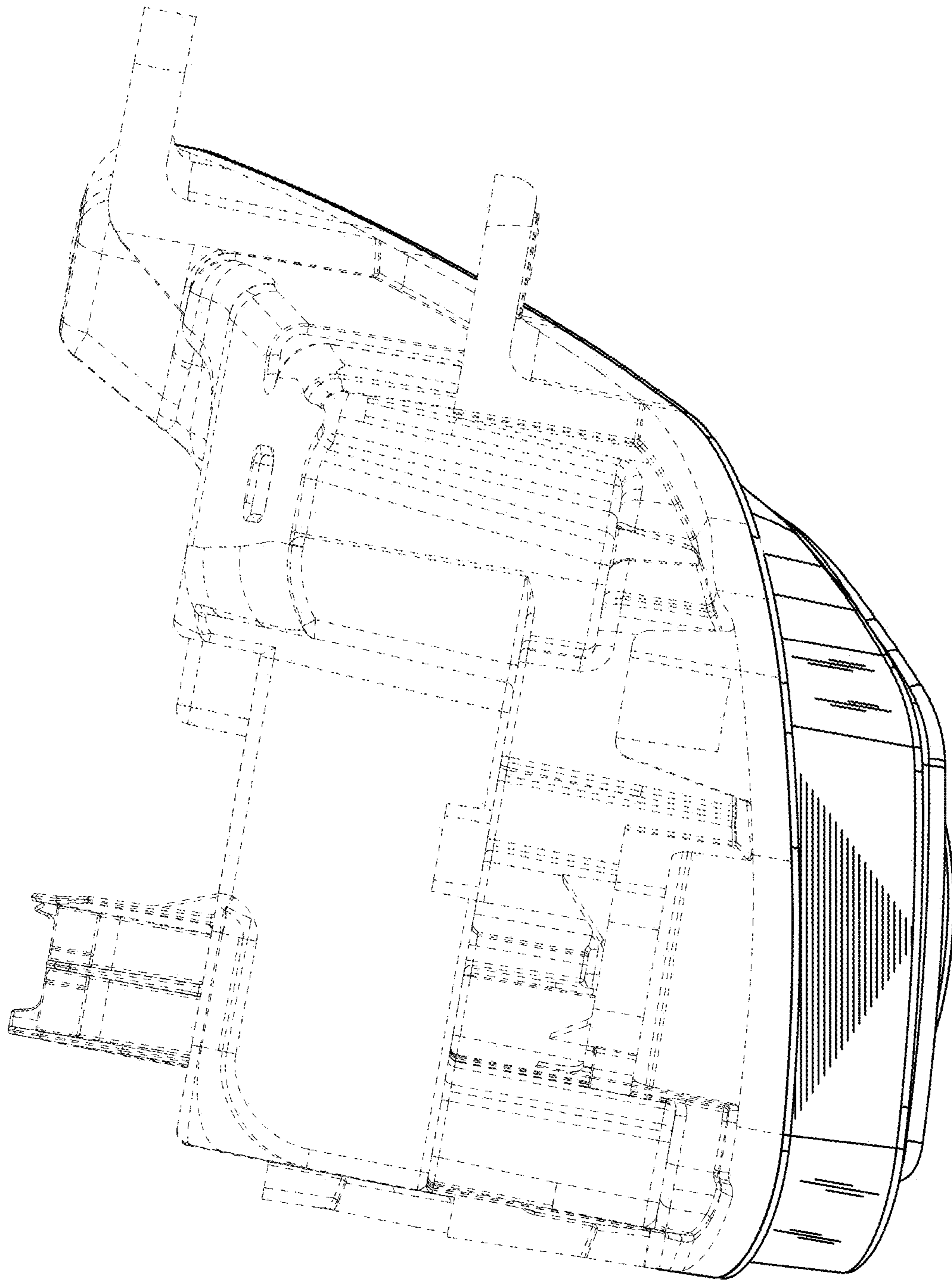

FIG. 8

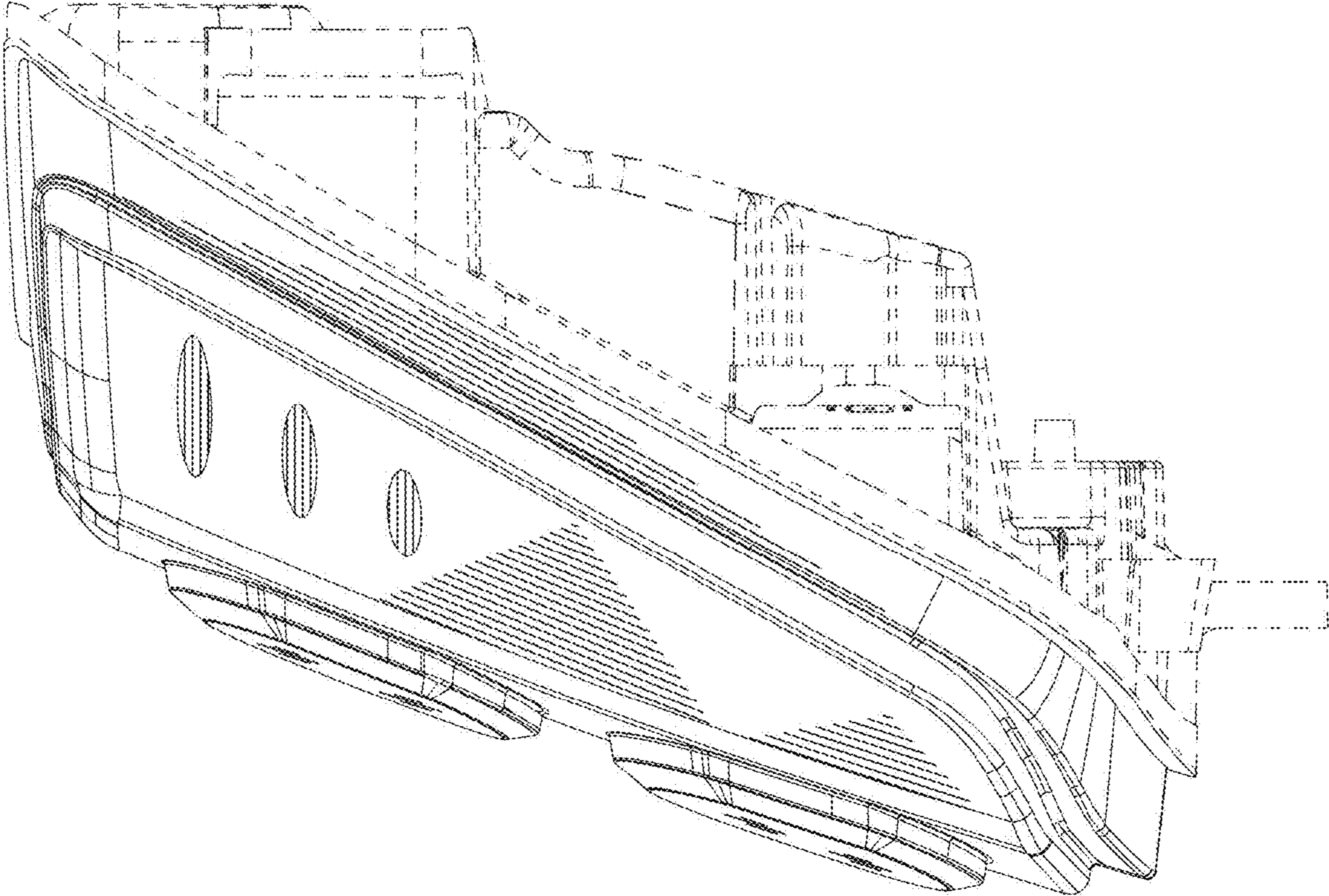

FIG 9

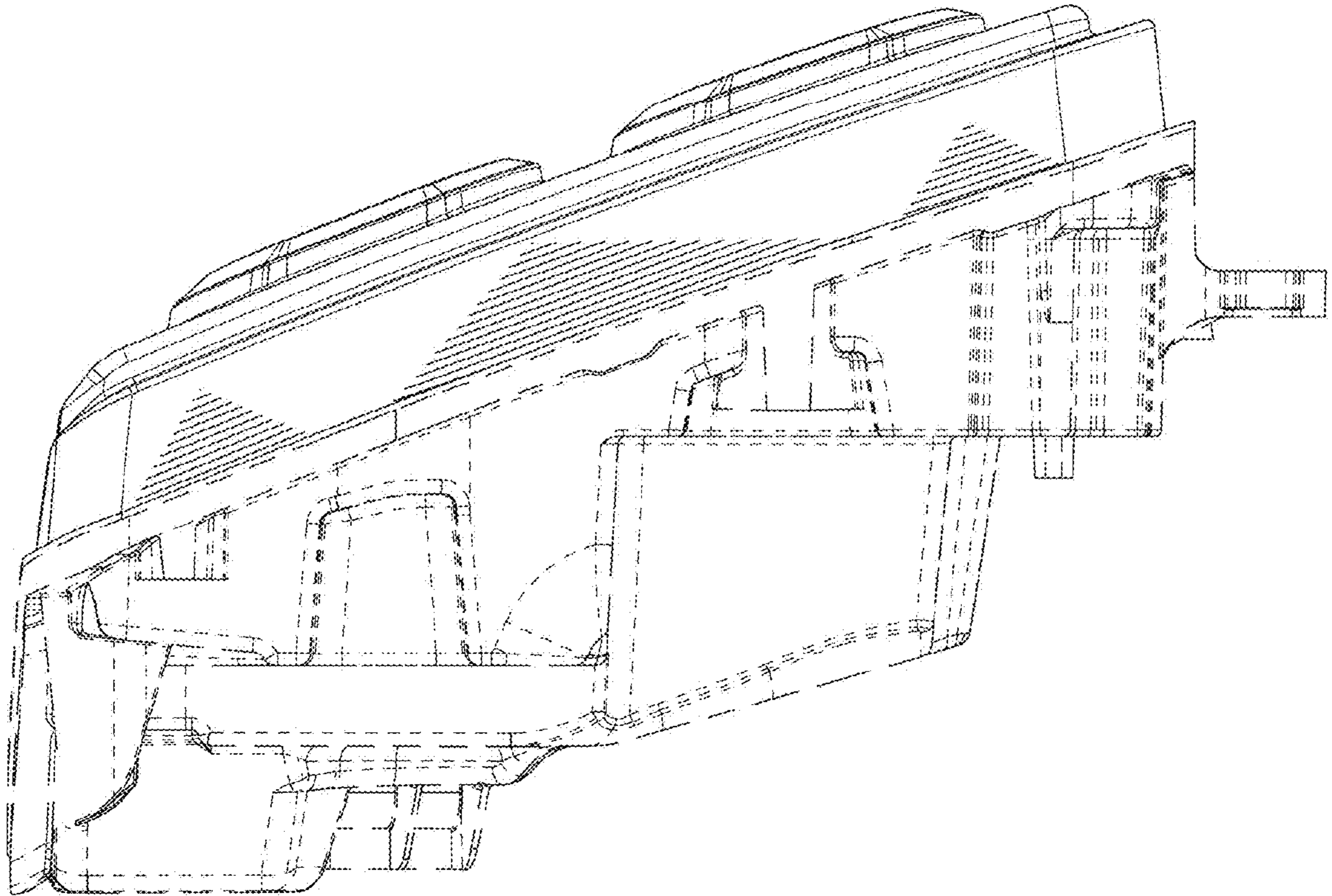

FIG.10