



US00D956273S

(12) **United States Design Patent**
Wang

(10) **Patent No.:** **US D956,273 S**
(45) **Date of Patent:** **** Jun. 28, 2022**

(54) **HANGING LAMP**

(71) Applicant: **Yongjun Wang**, Zhejiang (CN)

(72) Inventor: **Yongjun Wang**, Zhejiang (CN)

(**) Term: **15 Years**

(21) Appl. No.: **29/699,831**

(22) Filed: **Jul. 29, 2019**

(30) **Foreign Application Priority Data**

Jul. 5, 2019 (CN) 201930355816.X

(51) **LOC (13) Cl.** **26-03**

(52) **U.S. Cl.**
USPC **D26/24; D26/85**

(58) **Field of Classification Search**
USPC D26/24, 49, 51, 60, 72, 73, 78, 81, 83,
D26/85, 88, 90, 113, 118, 120, 123, 124,
D26/137, 154

CPC F21S 8/04; F21S 8/06; F21S 8/033; F21S
8/036; F21S 8/038; F21S 8/043; F21S
8/063; F21S 8/061; F21S 8/066; F21V
21/00; F21V 21/02; F21V 21/10; F21V
21/34; F21V 21/008; F21V 21/042; F21V
21/104; F21V 3/00; F21V 7/043; F21V
17/00; F21Y 2103/20

See application file for complete search history.

(56) **References Cited**

U.S. PATENT DOCUMENTS

D310,576 S * 9/1990 Narbut D26/58
D496,485 S * 9/2004 Stekelenburg D20/42

D630,357 S * 1/2011 Chang D26/60
D655,857 S * 3/2012 Sabernig D26/113
D735,921 S * 8/2015 Khayat D26/37
D748,839 S * 2/2016 Boucher D26/85
10,422,939 B2 * 9/2019 Tarsa F21S 8/04
2013/0107572 A1 * 5/2013 Holman F21K 9/61
362/609

* cited by examiner

Primary Examiner — Wan Laymon

Assistant Examiner — Clint A Samuel

(57) **CLAIM**

The ornamental design for a hanging lamp, as shown and described.

DESCRIPTION

FIG. 1 is a perspective view of a hanging lamp showing my new design;
FIG. 2 is a front elevational view thereof;
FIG. 3 is a rear elevational view thereof;
FIG. 4 is a left side elevational view thereof;
FIG. 5 is a right side elevational view thereof;
FIG. 6 is a top plan view thereof;
FIG. 7 is a bottom plan view thereof;
FIG. 8 is a front, right and top perspective view thereof; and,
FIG. 9 is an exploded view of the design.

1 Claim, 9 Drawing Sheets

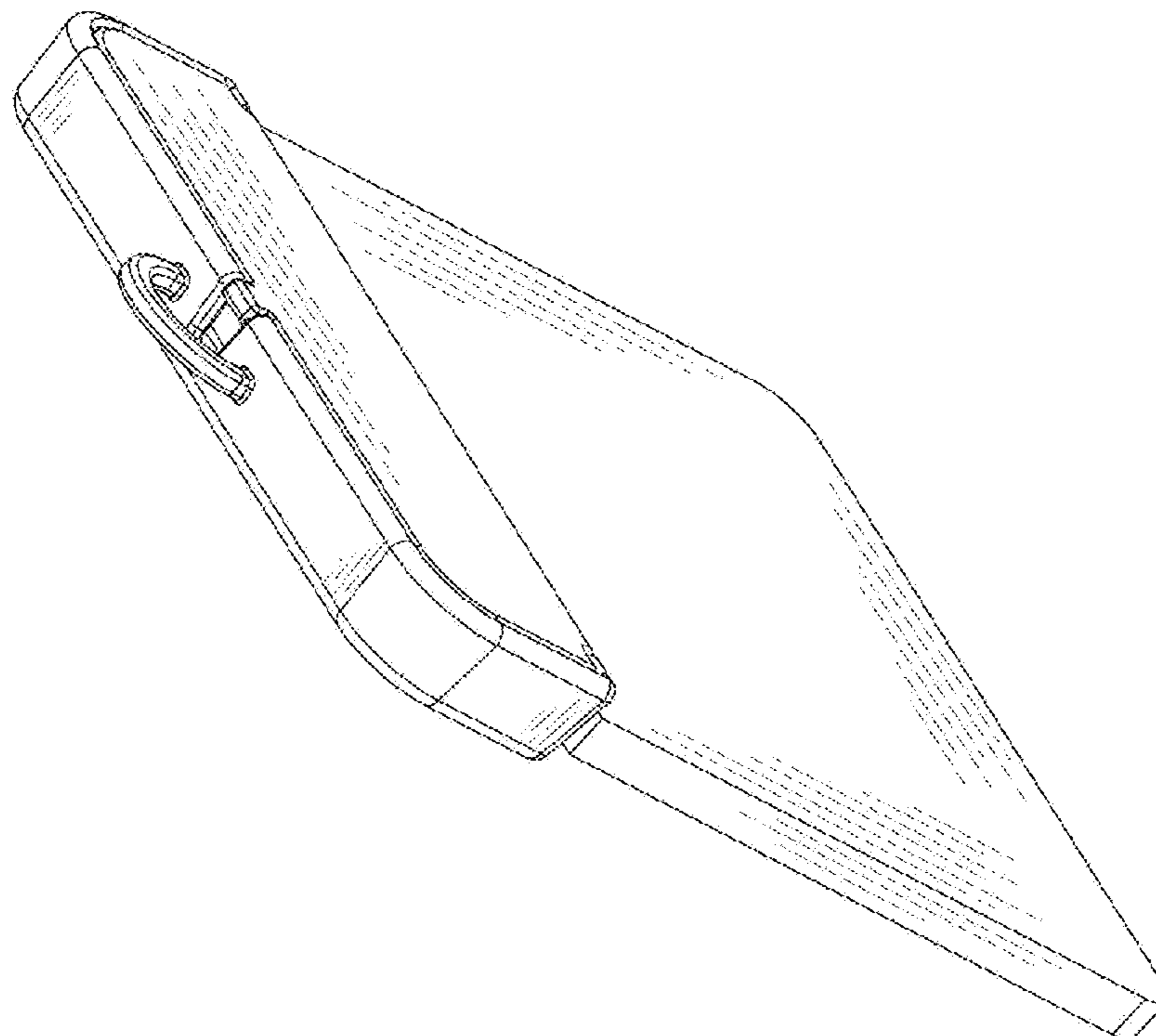

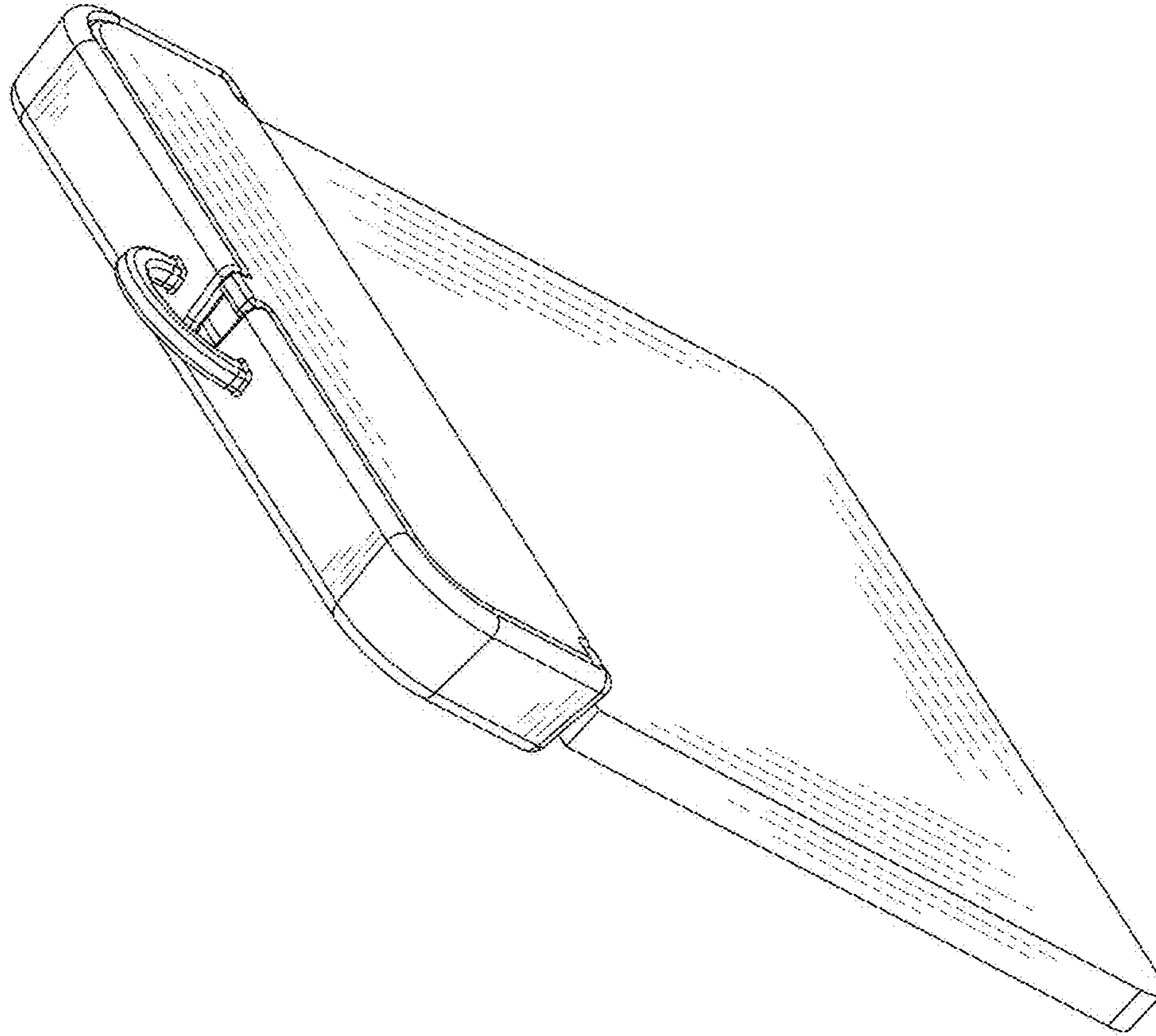

FIG. 1

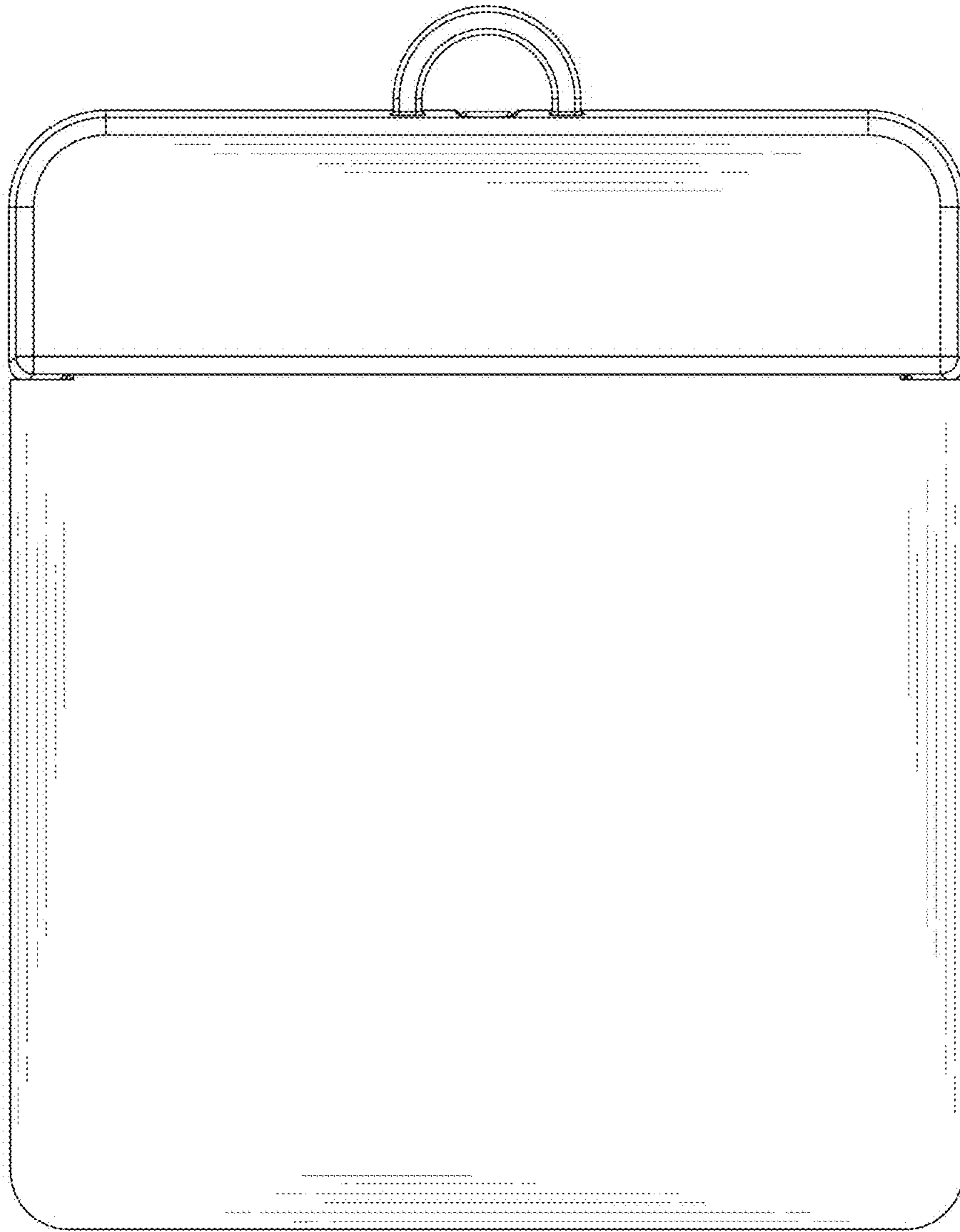

FIG. 2

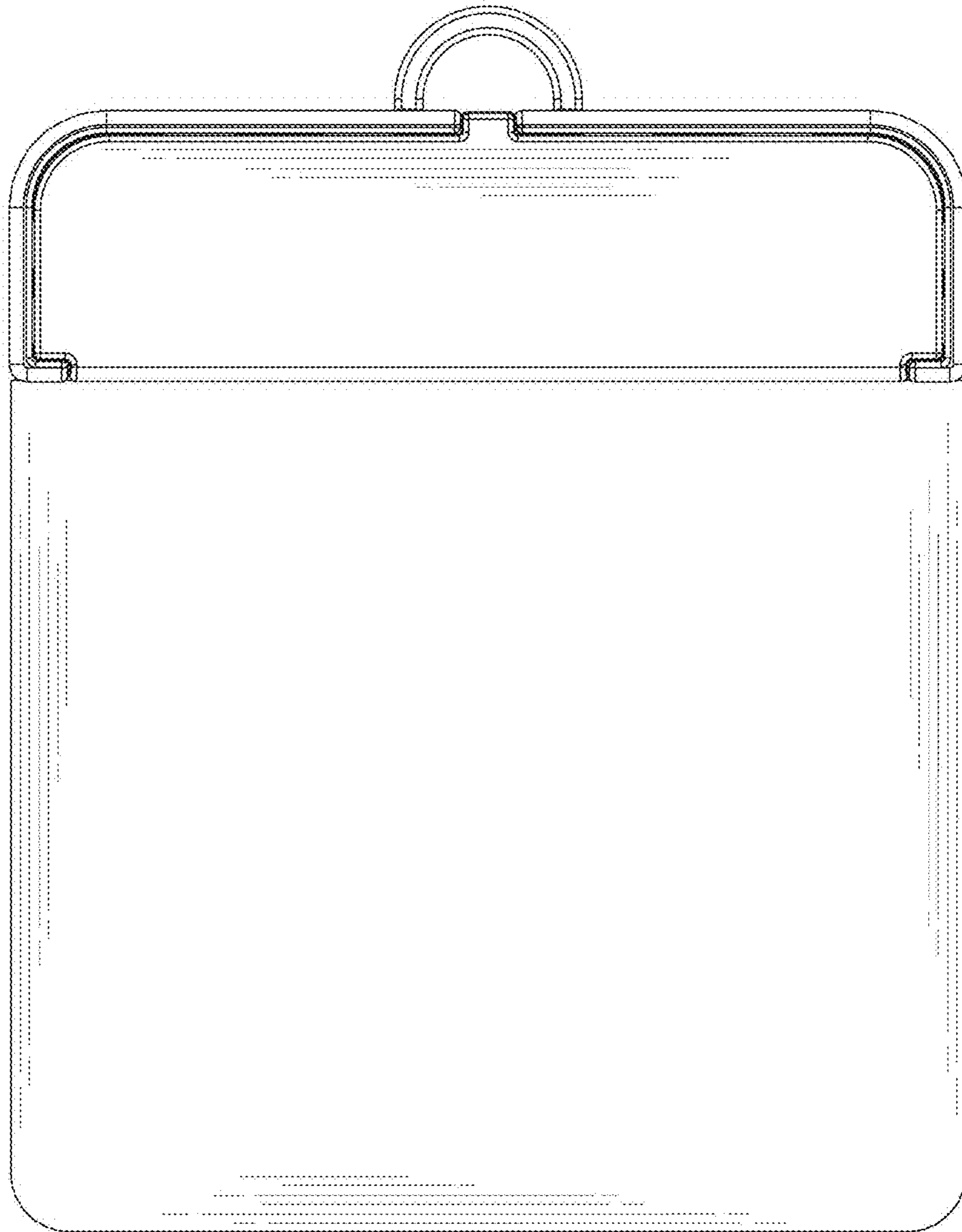

FIG. 3

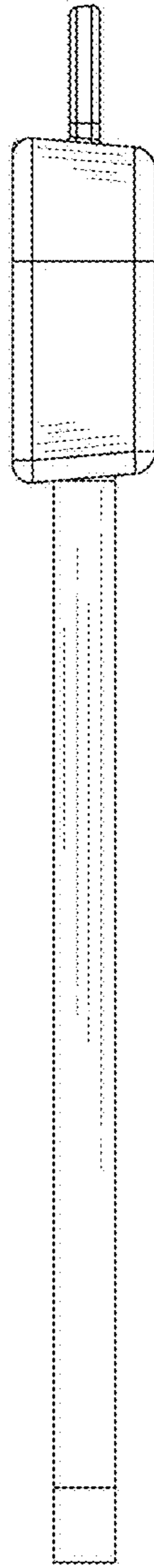

FIG. 4

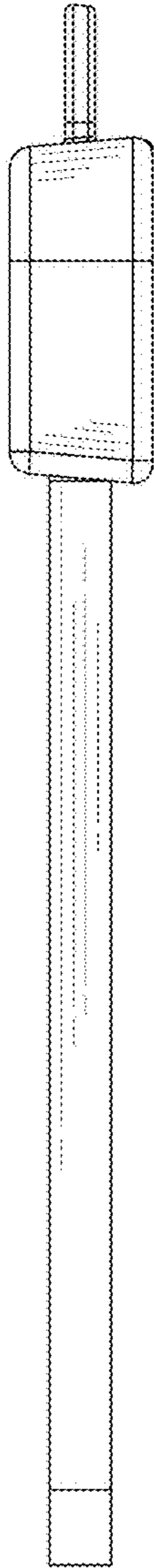

FIG. 5

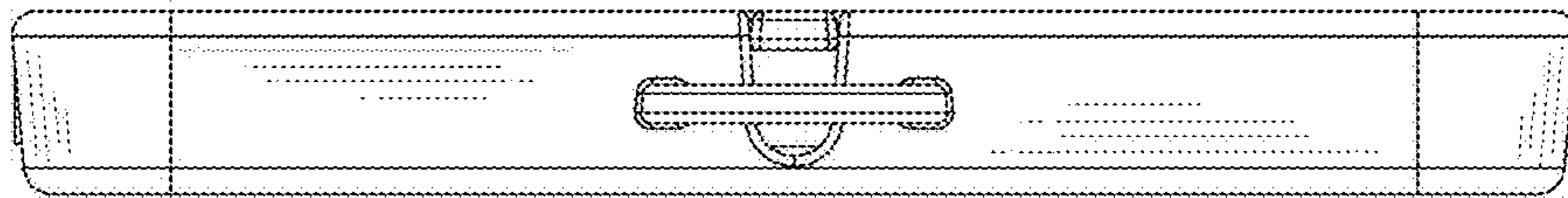

FIG. 6

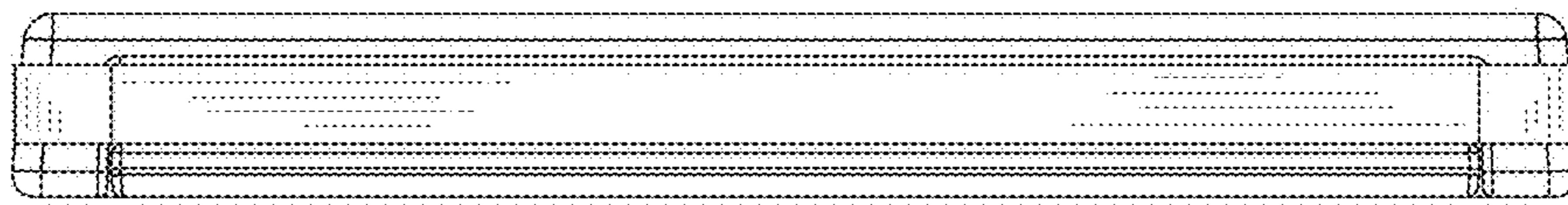

FIG. 7

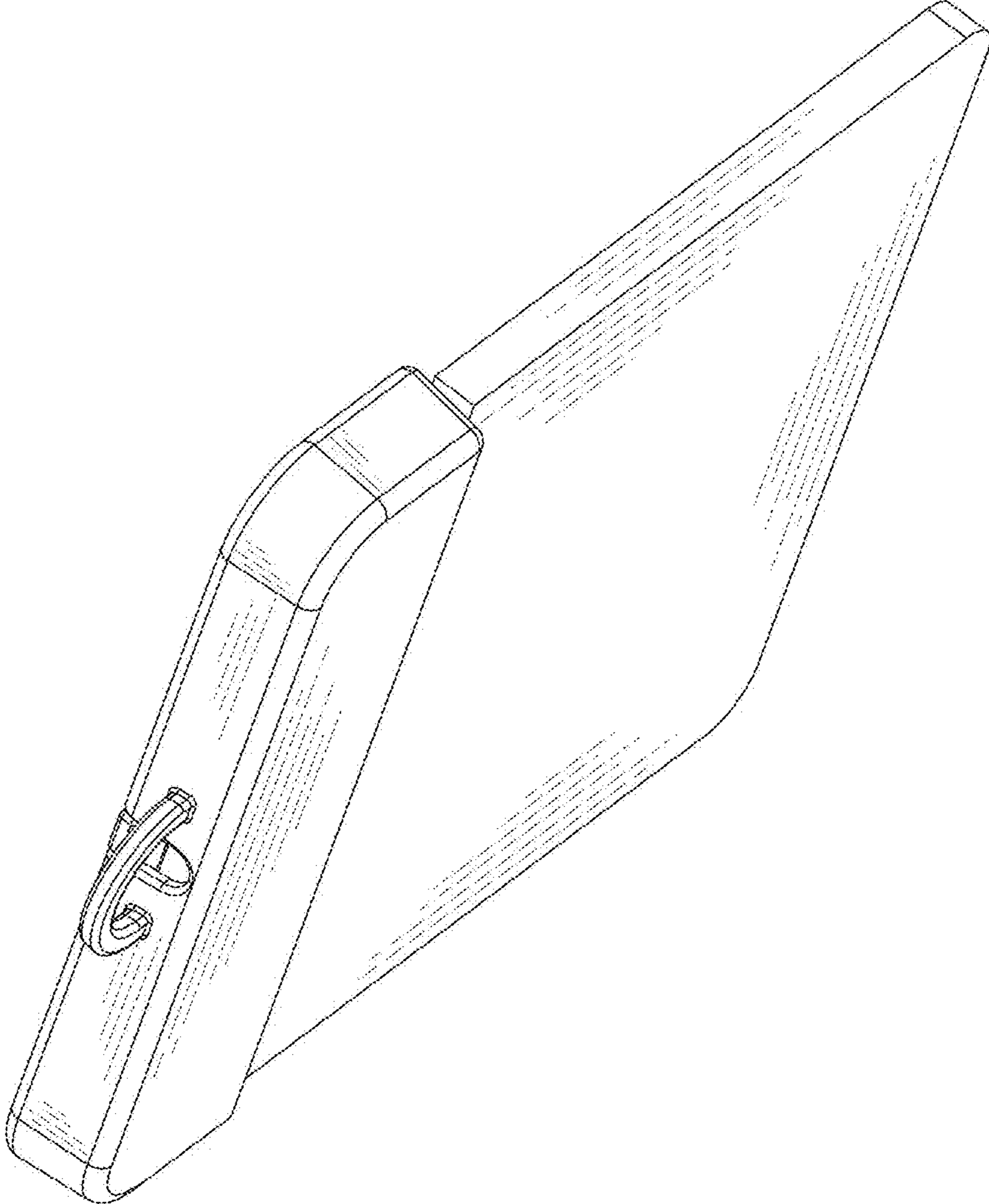

FIG. 8

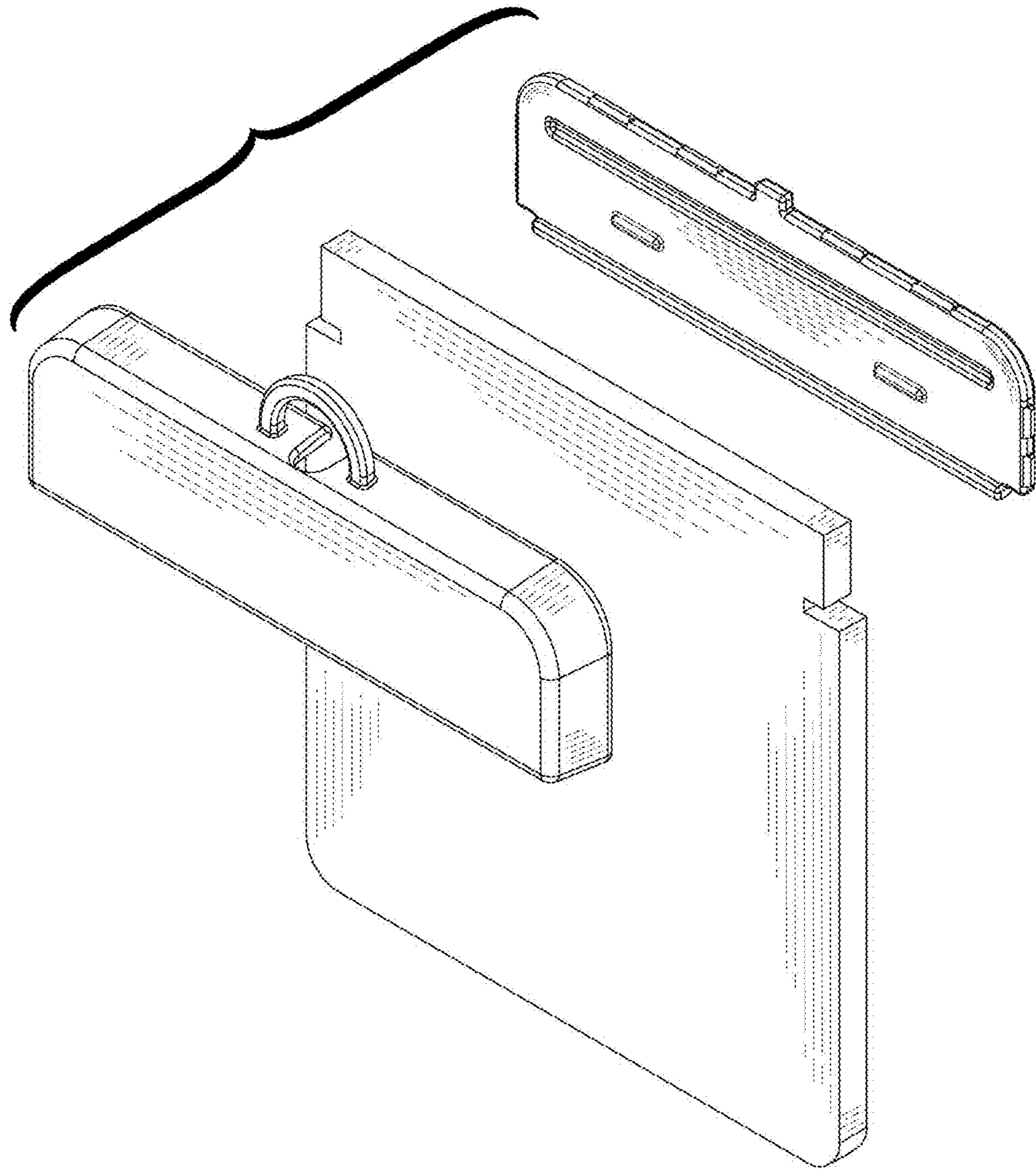

FIG. 9