



US00D956222S

(12) **United States Design Patent**
Vaughan et al.

(10) **Patent No.:** **US D956,222 S**
(45) **Date of Patent:** **** Jun. 28, 2022**

- (54) **SURGICAL BUR ASSEMBLY**
- (71) Applicant: **Stryker European Operations Limited**, Carrigtwohill (IE)
- (72) Inventors: **Aidan Vaughan**, Cork (IE); **Eoin Connolly**, Dublin (IE)
- (73) Assignee: **Stryker European Operations Limited**, Carrigtwohill (IE)
- (**) Term: **15 Years**
- (21) Appl. No.: **29/747,317**
- (22) Filed: **Aug. 21, 2020**
- (51) **LOC (13) Cl.** **24-02**
- (52) **U.S. Cl.**
USPC **D24/133**
- (58) **Field of Classification Search**
USPC D24/119, 133, 137, 138, 151, 146, 147, D24/152, 108, 111, 112, 113, 117, 118, D24/127, 130, 135, 141, 143, 144, 148, D24/153, 154, 170, 176, 179, 216, 222, D24/145, 150, 128, 129, 131; D8/51, 68, D8/107; D7/649
CPC ... A61B 17/3211; A61B 17/30; A61B 17/025; A61B 17/1604; A61B 17/06066; A61B 17/320016; A61B 17/3213; A61B 17/320068; A61B 18/14; A61F 9/00754; A61H 39/04; B26B 7/005; A61C 3/14; A61C 3/02
See application file for complete search history.

- 1,688,295 A * 10/1928 Maijgren A61B 1/307 600/154
 - 3,835,858 A * 9/1974 Hagen A61B 17/1633 606/180
 - 5,055,105 A * 10/1991 Hamlin A61B 17/1615 606/80
 - D332,492 S * 1/1993 Rosenberg D15/139
 - D344,903 S * 3/1994 Gampp, Jr. D10/78
- (Continued)

FOREIGN PATENT DOCUMENTS

- WO 2012138337 A1 10/2012
- WO 2018026369 A1 2/2018

Primary Examiner — T Chase Nelson
Assistant Examiner — Kelly L Gross
 (74) *Attorney, Agent, or Firm* — Howard & Howard Attorneys PLLC

(57) **CLAIM**

The ornamental design for a surgical bur assembly, as shown and described.

DESCRIPTION

FIG. 1 is a top, left-side, perspective view of a surgical bur assembly showing our new design;
 FIG. 2 is a top view thereof;
 FIG. 3 is a bottom view thereof;
 FIG. 4 is a left-side view thereof;
 FIG. 5 is a right-side view thereof;
 FIG. 6 is a front view thereof;
 FIG. 7 is a rear view thereof;
 FIG. 8 is an enlarged partial front, right-side perspective view thereof;
 FIG. 9 is an enlarged partial bottom view thereof; and,
 FIG. 10 is an enlarged, partial right-side view thereof.
 In the drawings, the broken lines represent unclaimed portions of the surgical bur assembly and form no part of the claimed design.

1 Claim, 4 Drawing Sheets

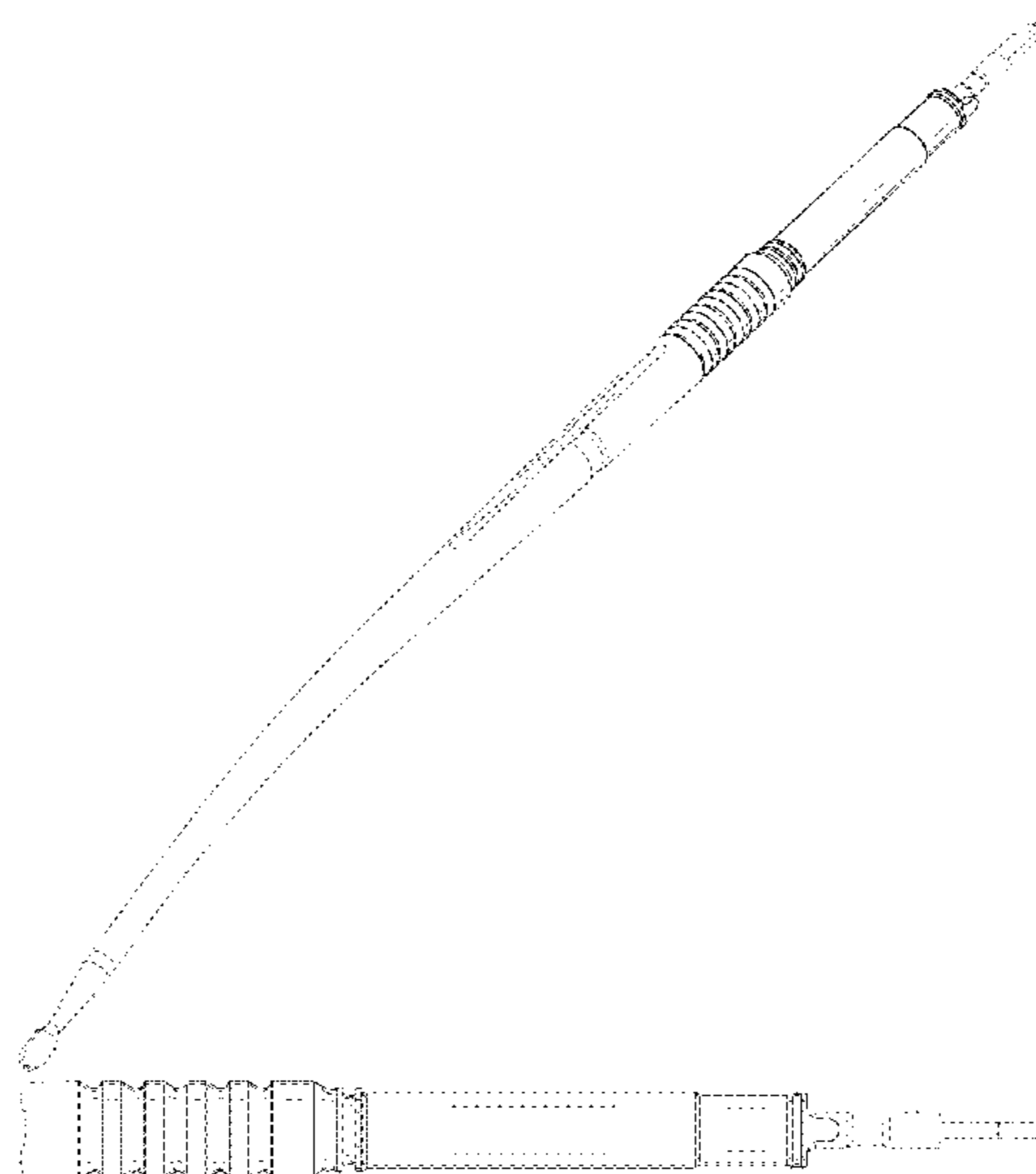

(56)	References Cited				
	U.S. PATENT DOCUMENTS				
5,352,234	A *	10/1994	Scott	A61B 17/1622	8,932,295 B1 *
				285/184	1/2015
5,505,737	A *	4/1996	Gosselin	A61B 17/32002	Greenhalgh
				279/75	A61B 17/1659
D372,311	S *	7/1996	Koros	D24/108	606/85
5,556,399	A *	9/1996	Huebner	A61B 10/025	
				408/207	
D380,265	S *	6/1997	Mark	D24/152	8,939,979 B2
5,667,509	A *	9/1997	Westin	A61B 17/1633	1/2015
				606/170	Del Rio et al.
D393,715	S *	4/1998	Strickland	D24/133	8,961,519 B2
5,752,969	A *	5/1998	Cunei	A61B 17/02	2/2015
				604/272	Gillard et al.
6,004,326	A *	12/1999	Castro	A61F 2/4611	D723,682 S *
				606/99	3/2015
6,120,511	A *	9/2000	Chan	A61B 17/1637	Kleiner
				606/102	D24/133
D433,504	S *	11/2000	Mark	D24/119	D726,289 S *
D440,305	S *	4/2001	Mark	D24/119	4/2015
D475,785	S *	6/2003	Chang	D19/177	Mahmood
D484,595	S *	12/2003	Ryan	D24/133	D23/266
D484,596	S *	12/2003	Ryan	D24/133	D736,916 S *
7,001,391	B2	2/2006	Estes et al.		8/2015
7,011,661	B2	3/2006	Riedel et al.		Appling
7,066,940	B2	6/2006	Riedel		D24/130
D537,942	S *	3/2007	Cronin	D24/144	9,108,020 B1 *
D540,468	S *	4/2007	Mori	D24/130	8/2015
D546,948	S *	7/2007	Huttner	D24/133	Feloney
7,243,580	B2	7/2007	Frazee		A61M 25/0017
D567,378	S *	4/2008	Nordahl	D24/156	del Rio et al.
D582,552	S *	12/2008	Berberich	D24/133	9,113,917 B2
D588,697	S *	3/2009	Hickok	D24/144	8/2015
D590,943	S *	4/2009	Petersen	D24/141	Bennett
D590,945	S *	4/2009	Berberich	D24/133	D24/147
D593,202	S *	5/2009	Petersen	D24/133	D744,652 S *
D594,119	S *	6/2009	Berberich	D24/108	12/2015
D597,670	S *	8/2009	Maissami	D24/152	Lazarus
D600,806	S *	9/2009	Horton	D24/133	D24/127
D601,251	S *	9/2009	Horton	D24/133	9,254,223 B2 *
D605,759	S *	12/2009	Cuevas	D24/133	2/2016
7,766,585	B2	8/2010	Vasudeva et al.		Medina
D631,962	S *	2/2011	Dorman	D24/135	A61F 9/00754
7,879,037	B2	2/2011	Brunnett et al.		9,308,013 B2 *
D642,268	S *	7/2011	Qureshi	D24/155	4/2016
7,992,878	B2	8/2011	Dace		Casey
8,016,523	B2	9/2011	Vasudeva et al.		A61B 17/32002
D648,021	S *	11/2011	Dorman	D24/135	D755,378 S *
D654,591	S *	2/2012	Gunnersen	D24/151	5/2016
D660,428	S *	5/2012	Hohl	D24/141	Dejima
D667,714	S *	9/2012	Ortiz	D8/89	D24/138
D668,520	S *	10/2012	Ortiz	D8/47	9,333,005 B2 *
8,357,163	B2	1/2013	Sidebotham et al.		5/2016
8,403,931	B2	3/2013	Sidebotham et al.		Schafer
D679,803	S *	4/2013	Carter	D24/112	A61B 17/32002
8,449,545	B2	5/2013	Sidebotham et al.		Quaye
8,460,297	B2	6/2013	Watlington et al.		A61B 17/1637
8,518,043	B2	8/2013	Sidebotham et al.		D24/138
8,518,044	B2	8/2013	Sidebotham et al.		9,381,023 B2
8,518,087	B2 *	8/2013	Lopez	A61B 17/3421	7/2016
				606/279	del Rio et al.
8,523,866	B2	9/2013	Sidebotham et al.		D762,854 S *
8,535,316	B2	9/2013	Lewis et al.		8/2016
8,540,716	B2	9/2013	Sidebotham et al.		Efinger
D692,134	S *	10/2013	Lee-Sepsick	D24/146	D24/144
8,556,897	B2	10/2013	Sidebotham et al.		D763,447 S *
D700,322	S *	2/2014	Kleiner	A61F 2/4455	8/2016
				D24/133	del Rio et al.
D701,305	S *	3/2014	Greco	D24/133	D765,602 S *
8,690,876	B2	4/2014	del Rio et al.		9/2016
8,728,058	B2 *	5/2014	Schertiger	A61M 25/0074	10/2016
				604/544	Moore et al.
8,801,713	B2	8/2014	del Rio et al.		Sidebotham et al.
8,870,873	B2	10/2014	Del Rio et al.		Nasu
					D13/154
					9,451,954 B2
					9/2016
					Moore et al.
					9,463,028 B2
					10/2016
					Sidebotham et al.
					D770,985 S *
					11/2016
					Nasu
					D13/154
					D771,808 S *
					11/2016
					Efinger
					D24/137
					D771,815 S *
					11/2016
					Huttner
					D24/151
					D773,664 S *
					12/2016
					DeNeui
					D24/147
					D776,259 S *
					1/2017
					Eldredge
					D24/112
					D782,042 S
					3/2017
					Dexter et al.
					D783,785 S *
					4/2017
					Bates-Hurtado
					D23/266
					D790,699 S
					6/2017
					Dexter et al.
					9,681,879 B2
					6/2017
					del Rio et al.
					9,687,257 B2
					6/2017
					Straslicka
					D797,290 S *
					9/2017
					Kleiner
					D24/147
					9,764,389 B2
					9/2017
					Kobayashi
					D800,903 S
					10/2017
					Heiliger
					D800,906 S
					10/2017
					Cihak
					D800,907 S
					10/2017
					Cihak
					9,820,756 B2
					11/2017
					del Rio et al.
					9,877,763 B2
					1/2018
					Barth et al.
					9,907,559 B2
					3/2018
					del Rio et al.
					10,039,870 B2 *
					8/2018
					Su
					A61M 1/84
					10,080,579 B2
					9/2018
					Cihak et al.
					10,092,300 B2
					10/2018
					del Rio et al.
					10,123,815 B2 *
					11/2018
					Huffenus
					A61B 17/320016
					D837,974 S *
					1/2019
					Hannon
					D24/112
					10,213,578 B2 *
					2/2019
					Fukuoka
					A61M 25/0069
					D843,061 S *
					3/2019
					Martone
					D28/65
					10,238,416 B2 *
					3/2019
					Stulen
					A61B 17/320068
					10,258,763 B2 *
					4/2019
					Grasse
					A61B 18/1492
					D854,742 S *
					7/2019
					Fisten
					D27/196
					D855,180 S *
					7/2019
					Haefliger
					D24/133
					D855,803 S *
					8/2019
					Dejima
					A61B 17/02
					D24/138
					D856,511 S *
					8/2019
					Kelly
					A61F 2/4611
					D24/112
					D867,590 S *
					11/2019
					Engler
					D24/138
					D871,576 S *
					12/2019
					Lohk
					A61B 17/32002
					D24/138
					10,543,122 B2 *
					1/2020
					Kahook
					A61F 9/0017
					D878,602 S *
					3/2020
					Chang
					D24/187
					D882,077 S *
					4/2020
					Schmitt
					D24/129
					D884,891 S *
					5/2020
					Solingen
					A61B 17/32002
					D24/143
					D893,714 S *
					8/2020
					Trezza
					A61B 17/1633
					D24/138
					10,729,478 B1 *
					8/2020
					Watts
					A61B 17/869
					D908,866 S *
					1/2021
					Fuentes-Ortega
					A61B 17/32002
					D24/112
					D915,593 S *
					4/2

(56)

References Cited

U.S. PATENT DOCUMENTS

D933,227 S * 10/2021 Cady A61F 9/007
D24/150
D934,424 S * 10/2021 Abt D24/150
D935,023 S * 11/2021 Le Faucheur D24/152
D938,583 S * 12/2021 Yan D24/133
D939,082 S * 12/2021 Ortiz A61F 9/007
D24/171
2003/0097133 A1* 5/2003 Green A61B 17/164
606/80
2005/0027282 A1* 2/2005 Schweikert A61M 25/0194
604/523
2007/0172321 A1* 7/2007 Nagai B23C 5/1009
407/53
2010/0063524 A1* 3/2010 McCombs A61B 17/32002
606/167
2011/0031505 A1 2/2011 Harada et al.
2016/0278788 A1 9/2016 Dexter et al.
2017/0159717 A1 6/2017 Marchand et al.
2017/0281196 A1 10/2017 del Rio et al.
2018/0036026 A1 2/2018 Inamdar
2018/0132865 A1 5/2018 del Rio et al.
2019/0041195 A1* 2/2019 Elzoghbi A61B 90/03
2019/0388086 A1* 12/2019 Gordon A61B 17/0401
2020/0046378 A1* 2/2020 Birkbeck A61B 17/1668
2020/0170652 A1* 6/2020 Kam A61B 17/1617

* cited by examiner

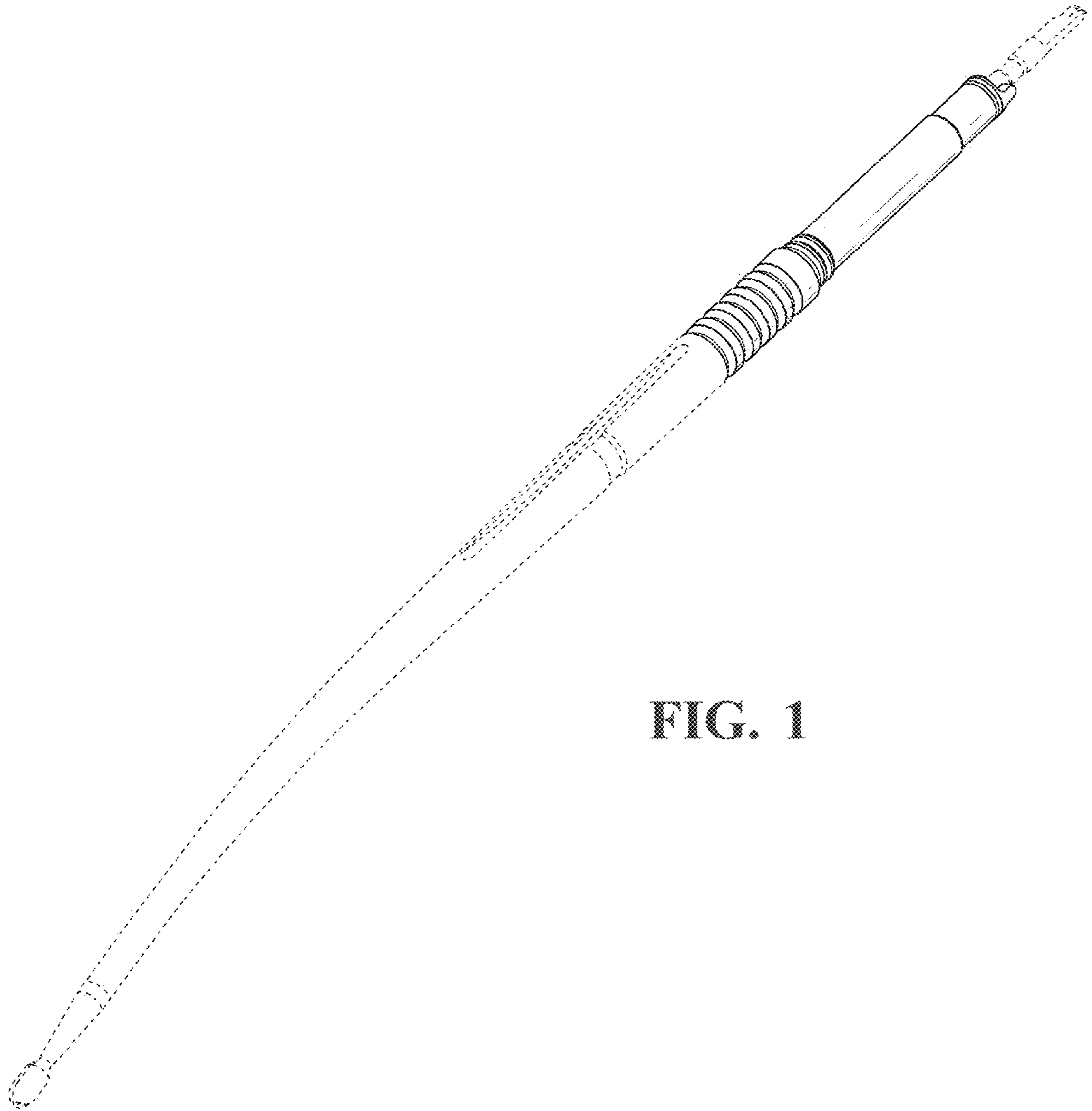

FIG. 1

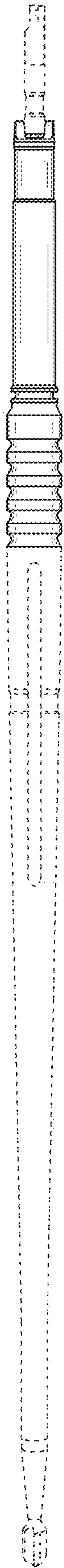

FIG. 2

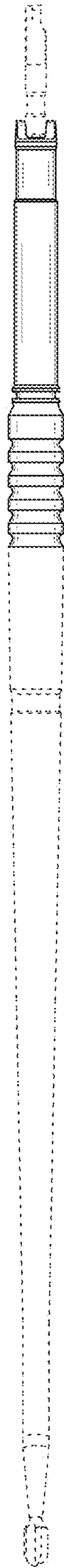

FIG. 3

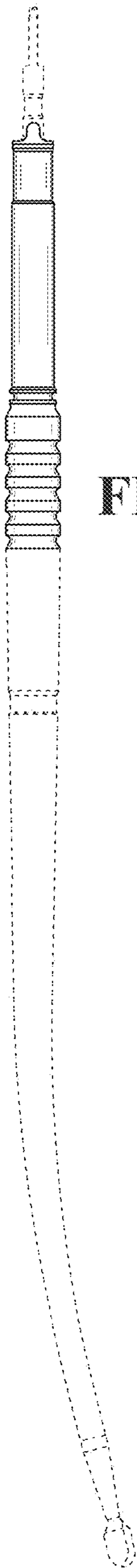

FIG. 4

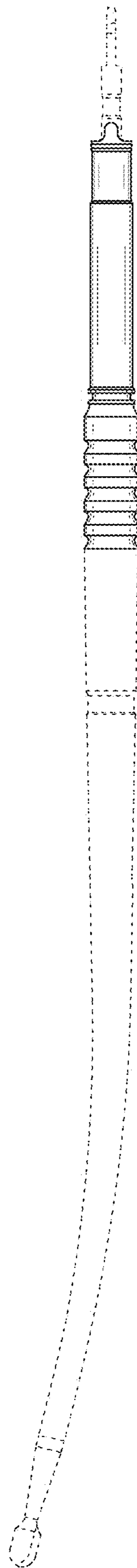

FIG. 5



FIG. 6



FIG. 7

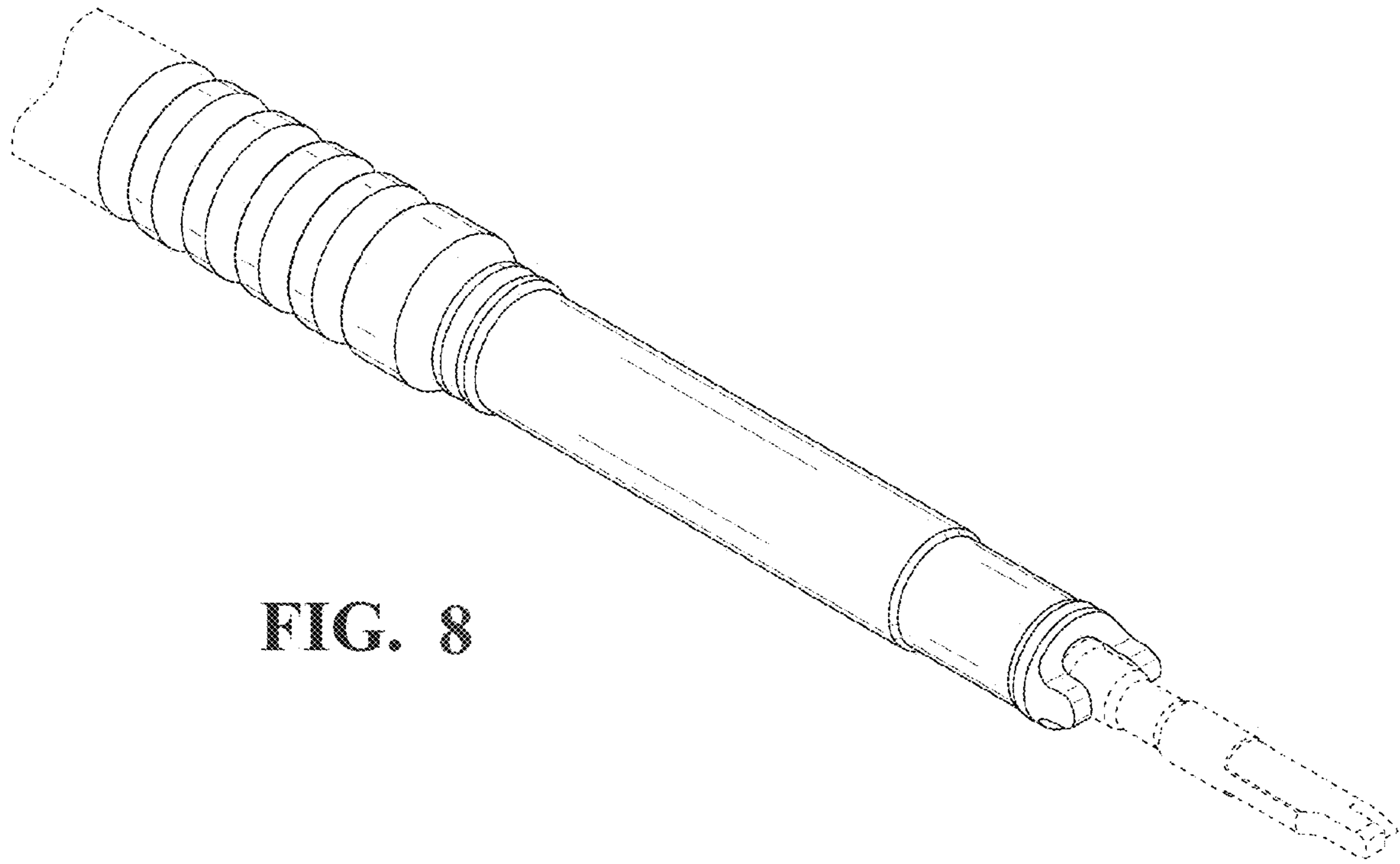

FIG. 8

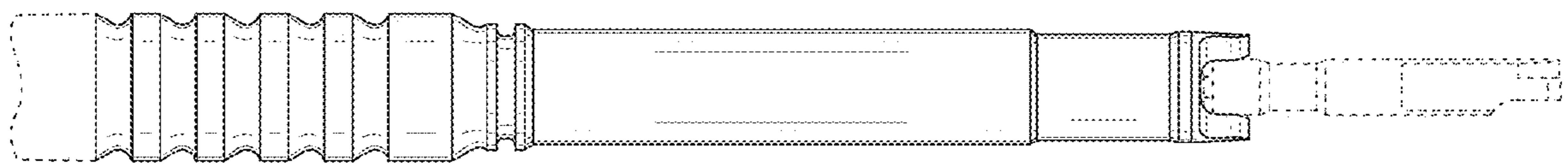

FIG. 9

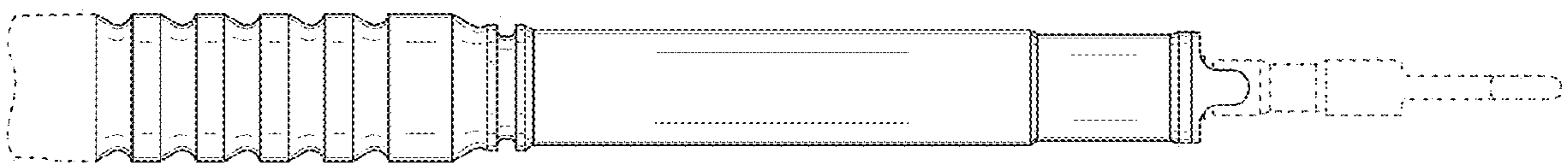

FIG. 10