



US00D956156S

(12) **United States Design Patent** (10) **Patent No.:** **US D956,156 S**
Clift et al. (45) **Date of Patent:** **** Jun. 28, 2022**

(54) **GOLF PUTTING PRACTICE DEVICE**

(71) Applicant: **THEREFORE LIMITED**, London (GB)

(72) Inventors: **Andrew Clift**, London (GB); **Martin Riddiford**, London (GB); **Gavin Flowers**, London (GB)

(73) Assignee: **Therefore Limited**, London (GB)

(**) Term: **15 Years**

(21) Appl. No.: **29/741,060**

(22) Filed: **Jul. 9, 2020**

(30) **Foreign Application Priority Data**

Jan. 17, 2020 (EM) 007525787-0001
Jan. 17, 2020 (EM) 007525787-0002

(51) **LOC (13) Cl.** **21-02**

(52) **U.S. Cl.**
USPC **D21/791**

(58) **Field of Classification Search**
USPC D21/789, 791, 792, 790
(Continued)

(56) **References Cited**

U.S. PATENT DOCUMENTS

1,287,903 A * 12/1918 Daily A63B 57/40
473/180
1,503,415 A * 7/1924 Fohmann A63F 7/305
273/123 R

(Continued)

FOREIGN PATENT DOCUMENTS

EM 006634036-0004 7/2019
GB 5004586 8/2016

OTHER PUBLICATIONS

Amazon.com; Pressure Putt Trainer; Mar. 2021.*

(Continued)

Primary Examiner — Mitchell I. Siegel

(74) *Attorney, Agent, or Firm* — Andrus Intellectual Property Law. LLP

(57) **CLAIM**

The ornamental design for a golf putting practice device, as shown and described.

DESCRIPTION

FIG. 1 is a front-top perspective view of a first embodiment of a golf putting practice device according to our new and ornamental design;

FIG. 2 is a rear-bottom perspective view thereof;

FIG. 3 is a front elevation view thereof;

FIG. 4 is a rear elevation view thereof;

FIG. 5 is a right side elevation view thereof;

FIG. 6 is a left side elevation view thereof;

FIG. 7 is a top plan view thereof;

FIG. 8 is a bottom plan view thereof;

FIG. 9 is a front-top perspective view thereof, showing the first embodiment of the golf putting practice device in an alternative configuration;

FIG. 10 is a rear-bottom perspective view thereof, showing the first embodiment of the golf putting practice device in the alternative configuration;

FIG. 11 is a front-top perspective view of a second embodiment of a golf putting practice device according to our new and ornamental design;

FIG. 12 is a rear-bottom perspective view thereof;

FIG. 13 is a front elevation view thereof;

FIG. 14 is a rear elevation view thereof;

FIG. 15 is a right side elevation view thereof;

FIG. 16 is a left side elevation view thereof;

FIG. 17 is a top plan view thereof;

FIG. 18 is a bottom plan view thereof;

FIG. 19 is a front-top perspective view thereof, showing the second embodiment of the golf putting practice device in a first alternative configuration;

FIG. 20 is a rear-bottom perspective view thereof, showing the second embodiment of the golf putting practice device in the first alternative configuration;

(Continued)

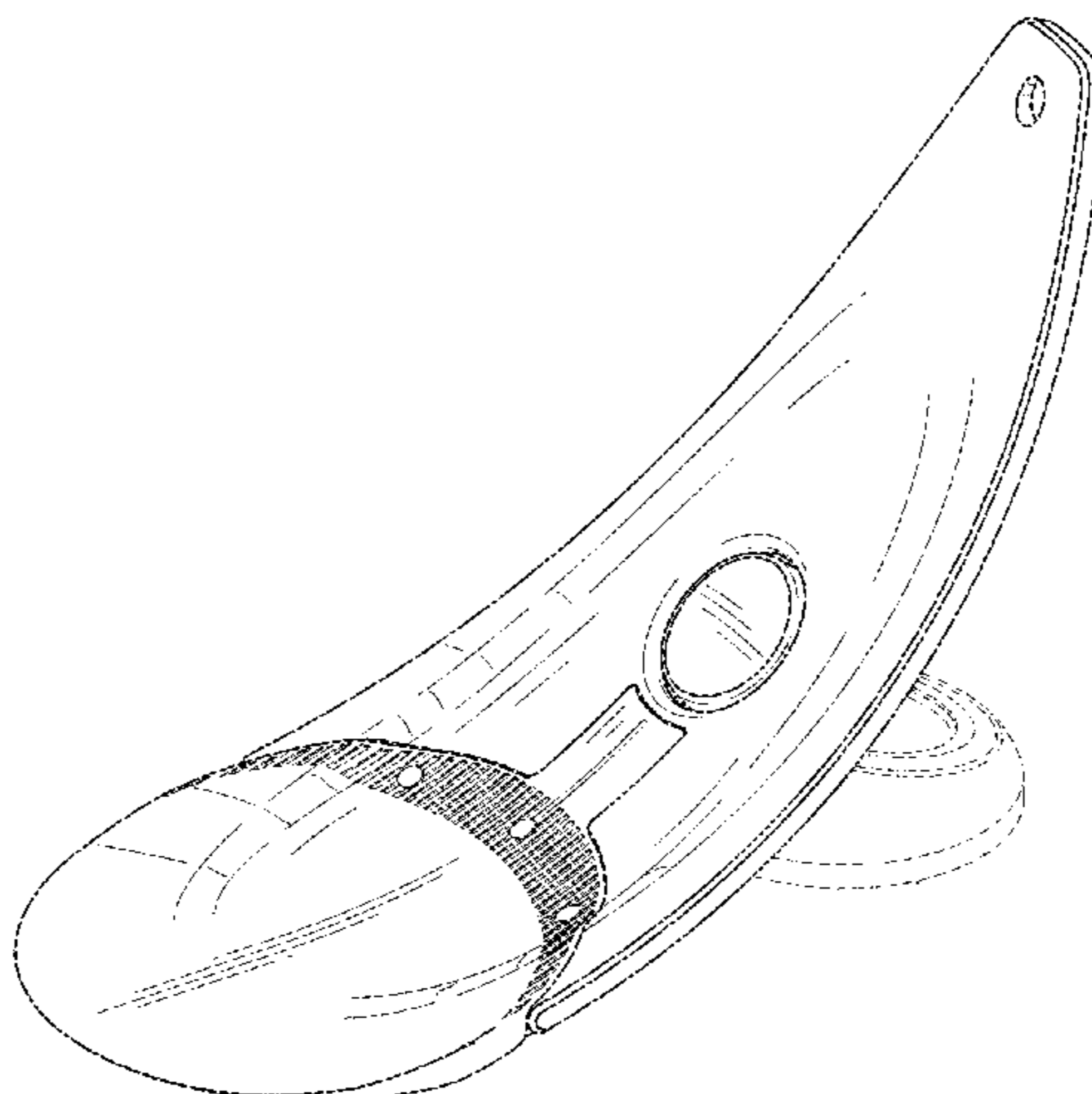

FIG. 21 is a front-top perspective view thereof, showing the second embodiment of the golf putting practice device in a second alternative configuration;

FIG. 22 is a rear-bottom perspective view thereof, showing the second embodiment of the golf putting practice device in the second alternative configuration;

FIG. 23 is a front elevation view thereof, showing the second embodiment of the golf putting practice device in the second alternative configuration;

FIG. 24 is a rear elevation view thereof, showing the second embodiment of the golf putting practice device in the second alternative configuration;

FIG. 25 is a right side elevation view thereof, showing the second embodiment of the golf putting practice device in the second alternative configuration;

FIG. 26 is a left side elevation view thereof, showing the second embodiment of the golf putting practice device in the second alternative configuration;

FIG. 27 is a top plan view thereof, showing the second embodiment of the golf putting practice device in the second alternative configuration; and,

FIG. 28 is a bottom plan view thereof, showing the second embodiment of the golf putting practice device in the second alternative configuration.

The evenly dashed broken lines illustrate portions of the golf putting practice device that form no part of the claim. The dash-dot broken lines represent the boundaries of the claimed design and form no part of the claim.

1 Claim, 20 Drawing Sheets

(58) **Field of Classification Search**

CPC . A63B 69/36; A63B 69/3608; A63B 69/3676; A63B 69/3661; A63B 69/3667; A63B 69/3697; A63B 57/40

See application file for complete search history.

(56) **References Cited**

U.S. PATENT DOCUMENTS

1,637,407 A * 8/1927 Brumder A63B 57/357
473/184
1,689,475 A * 10/1928 Brumder A63B 57/357
473/192
2,453,605 A * 11/1948 Thomas A63B 69/3661
473/180
2,716,029 A * 8/1955 Montgomery A63B 57/357
473/184
D196,657 S * 10/1963 Cohen D21/790
D201,689 S * 7/1965 Lindner D21/790
3,275,325 A * 9/1966 MacKenzie A63B 57/405
273/125 R
3,727,918 A * 4/1973 Zawacki A63B 67/02
473/159
3,762,718 A * 10/1973 Culley A63B 57/40
473/160
3,817,535 A * 6/1974 Doughty A63F 7/305
473/185
D242,370 S * 11/1976 Arndt et al. D21/790
4,203,604 A * 5/1980 La Grange A63B 69/3661
473/185
D273,126 S * 3/1984 Turza D21/790

4,805,912 A * 2/1989 Hickman A63B 69/3676
473/159
D311,216 S * 10/1990 Simjian D21/790
5,129,653 A * 7/1992 Morris A63B 67/02
473/184
5,301,947 A * 4/1994 Kim A63B 67/02
473/163
D353,433 S * 12/1994 Erdoes D21/792
5,421,578 A * 6/1995 Ames A63B 69/3676
473/260
5,573,247 A * 11/1996 Ridge A63B 69/3676
273/271
5,595,543 A * 1/1997 Wolk A63B 67/02
473/162
5,630,719 A * 5/1997 Franklin A63B 69/3676
473/157
D382,601 S * 8/1997 Antill D21/303
D392,010 S * 3/1998 Ridge D21/790
D399,285 S * 10/1998 Ridge D21/789
D400,631 S * 11/1998 Moore D21/791
D409,704 S * 5/1999 Nunes D21/791
D411,601 S * 6/1999 Fong D21/791
D418,891 S * 1/2000 Sirak D21/791
D431,855 S * 10/2000 Rose D21/791
6,569,027 B2 * 5/2003 Florian A63B 67/02
473/163
D481,092 S * 10/2003 Ray D21/791
D487,128 S * 2/2004 Miller D21/791
7,255,648 B1 * 8/2007 Romeo A63B 69/3676
473/180
D600,299 S * 9/2009 Hanley D21/791
7,597,558 B2 * 10/2009 Mazloompour ... A63B 69/0097
434/247
8,235,880 B2 * 8/2012 Guier A63B 57/20
206/579
D673,635 S * 1/2013 Cameron D21/791
D696,371 S * 12/2013 Wilkie D21/791
D696,740 S * 12/2013 Wilkie D21/791
D728,719 S * 5/2015 Starrs D21/791
D740,383 S * 10/2015 Shadle D21/791
D759,162 S * 6/2016 Menzies D20/19
D760,337 S * 6/2016 Holland D21/791
D856,430 S * 8/2019 Cangi D21/303
D862,622 S * 10/2019 Goserud D21/791
10,940,378 B1 * 3/2021 Offerman A63B 71/0622
D924,343 S * 7/2021 McCudden D21/686
D933,153 S * 10/2021 McDonald D21/791
D936,775 S * 11/2021 Yevchak D21/789
D941,413 S * 1/2022 Light D21/789
2003/0109318 A1 * 6/2003 Oyauchi A63B 24/0021
473/192
2004/0005933 A1 * 1/2004 Maruszczak A63B 69/3676
473/192
2011/0124427 A1 * 5/2011 Green A63B 69/3661
473/409
2014/0364244 A1 * 12/2014 Ross A63B 63/00
473/173
2020/0129833 A1 * 4/2020 Cooper A63B 69/3676

OTHER PUBLICATIONS

Amazon.com; Putout Pressure Putt Trainer; Nov. 2021.*
Amazon.com; PuttOut Platinum Pressure Putt Trainer; Oct. 2021.*
Amazon.com; PittOut Pressure Putt Trainer; Aug. 2018.*
PuttOut, "PuttOUT Pressure Putt Trainer—Perfect Your Golf Putting," pressure putt trainer, available at least as early as Mar. 3, 2018, available at https://www.amazon.co.uk/PuttOUT-Pressure-Putt-Trainer-Perfect/dp/B01N9BXYW3?ref_ast_sto_dp&th=1.
Clift et al., "Golf Ball," Design U.S. Appl. No. 29/677,444, filed Jan. 21, 2019 (drawings, specification, and appendix only).

* cited by examiner

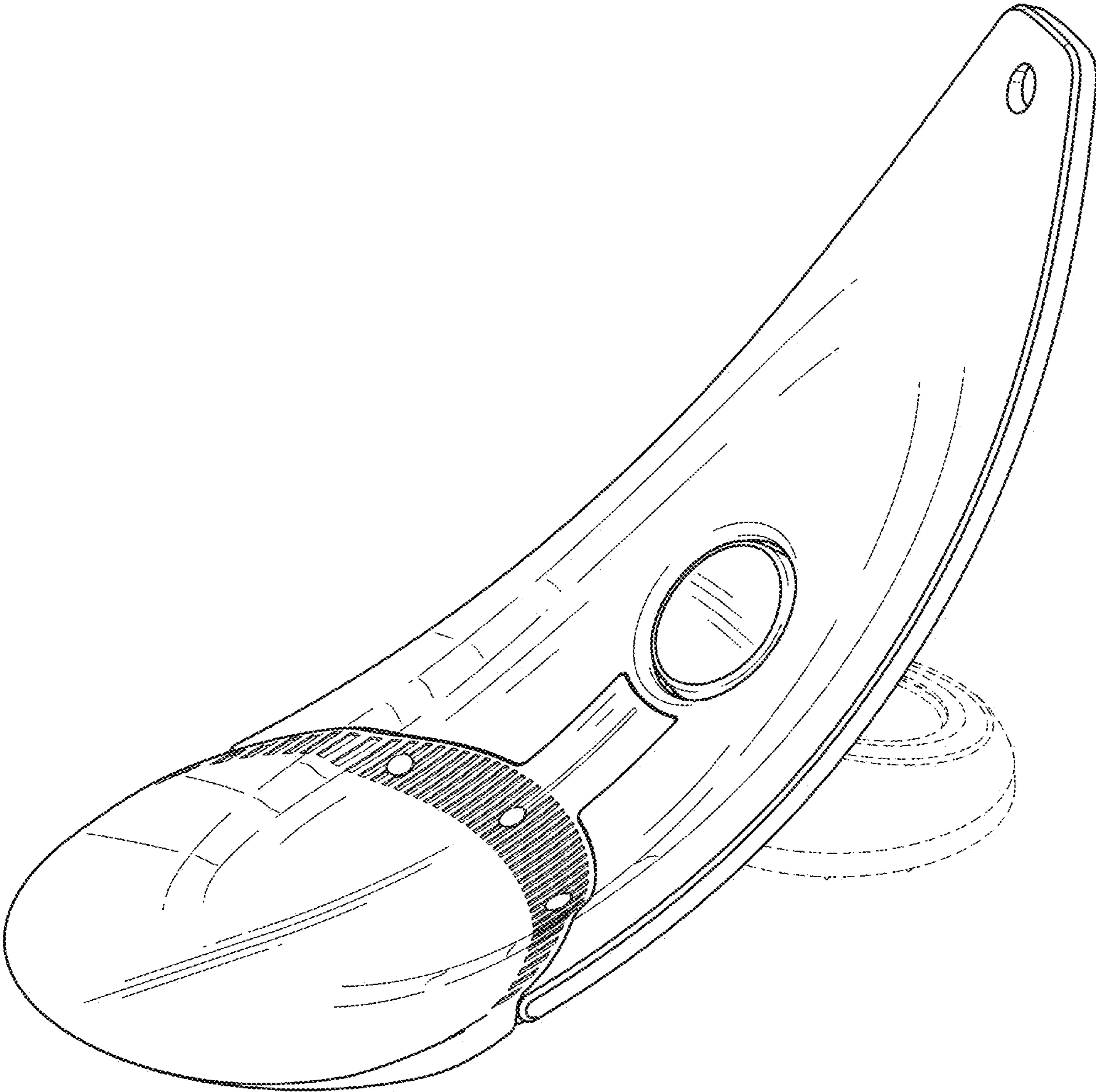

FIG. 1

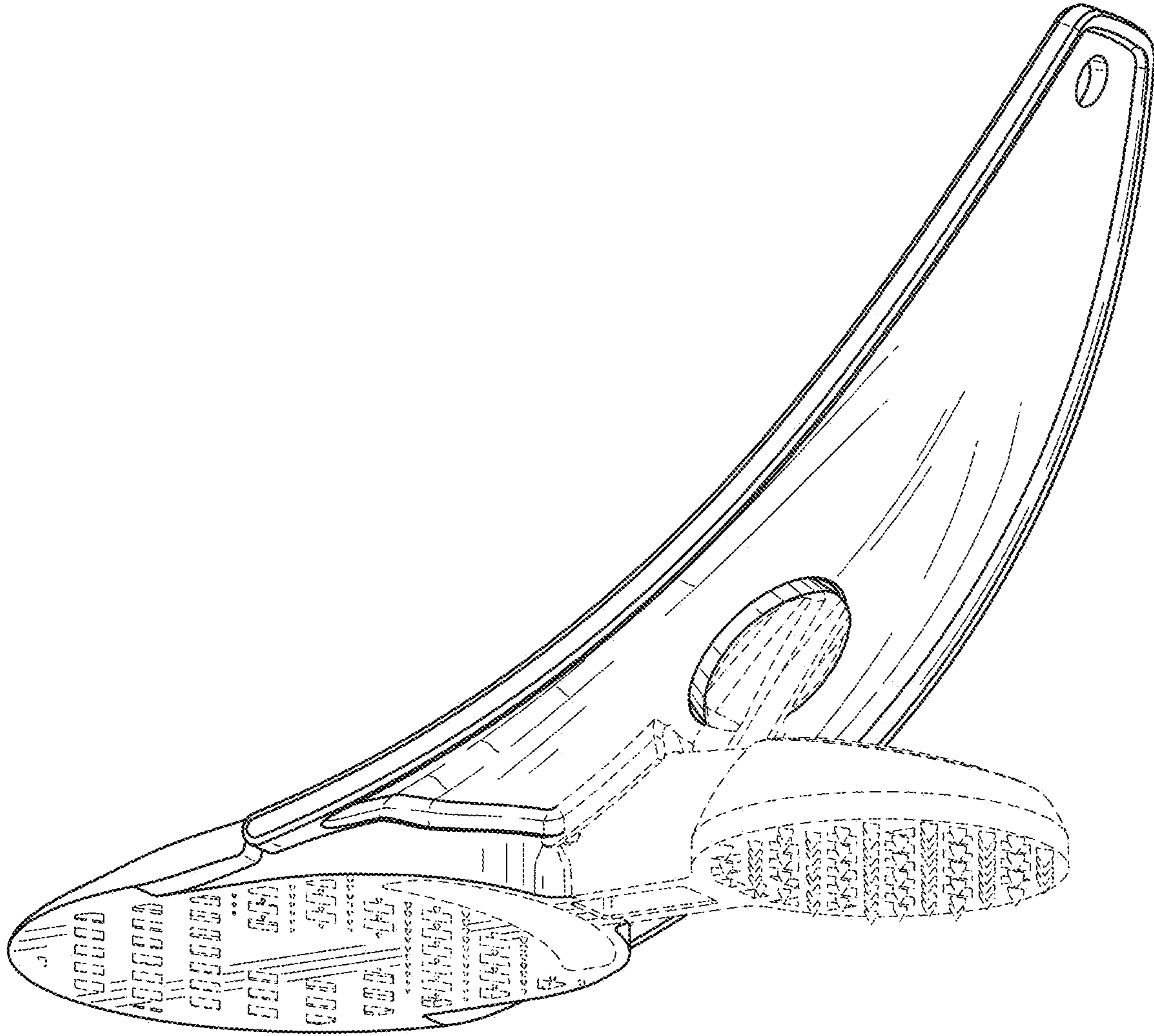

FIG. 2

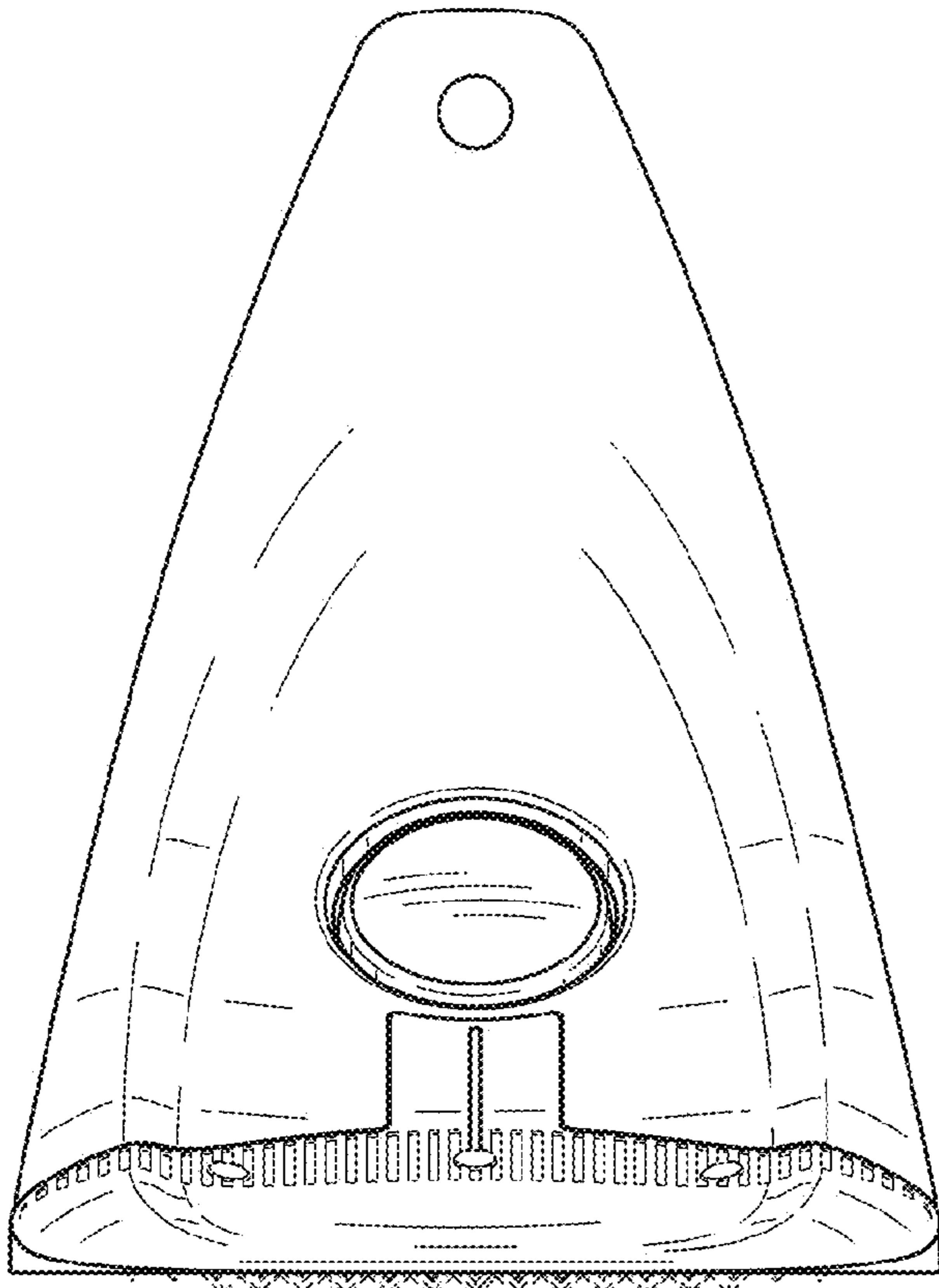

FIG. 3

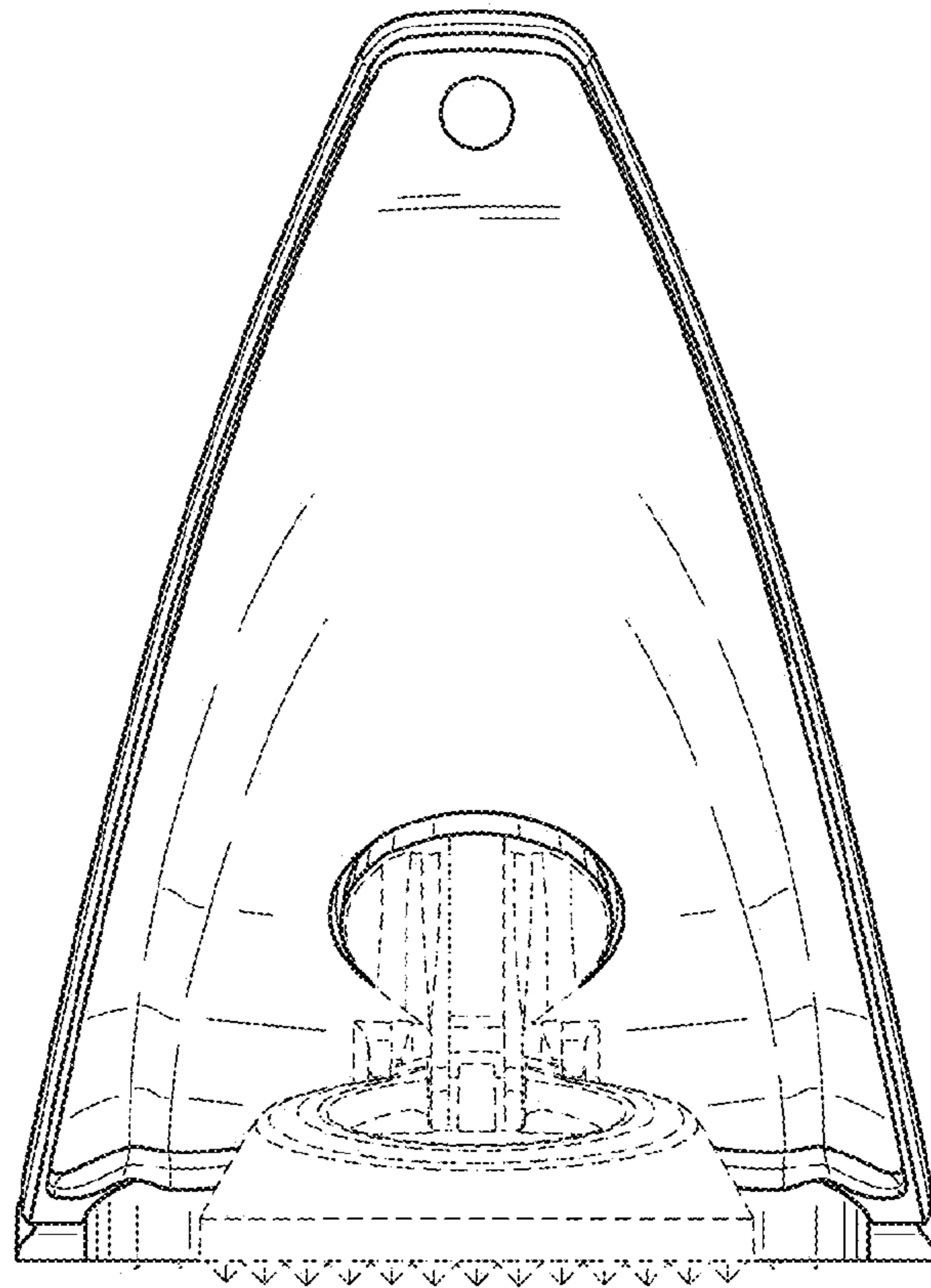

FIG. 4

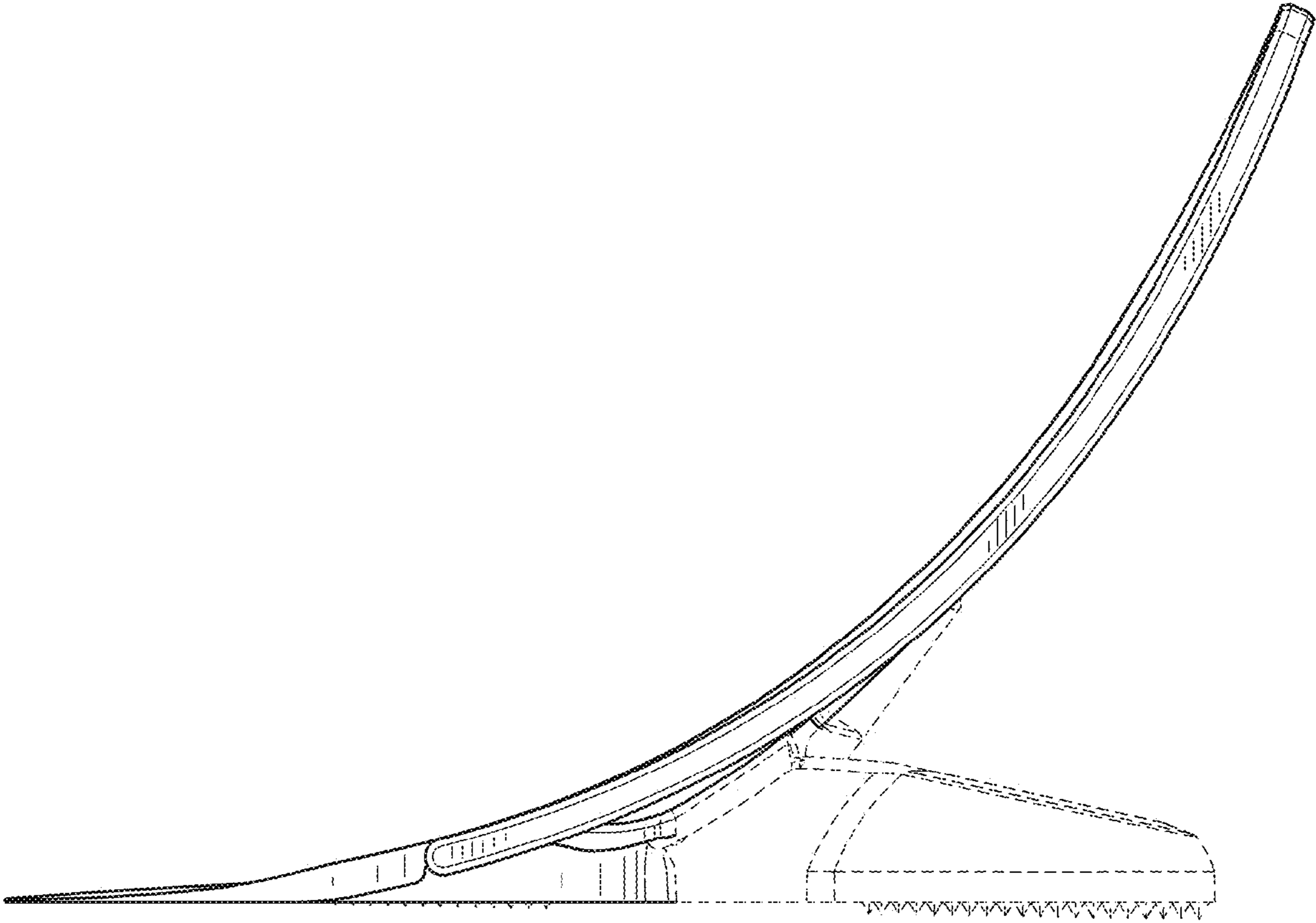

FIG. 5

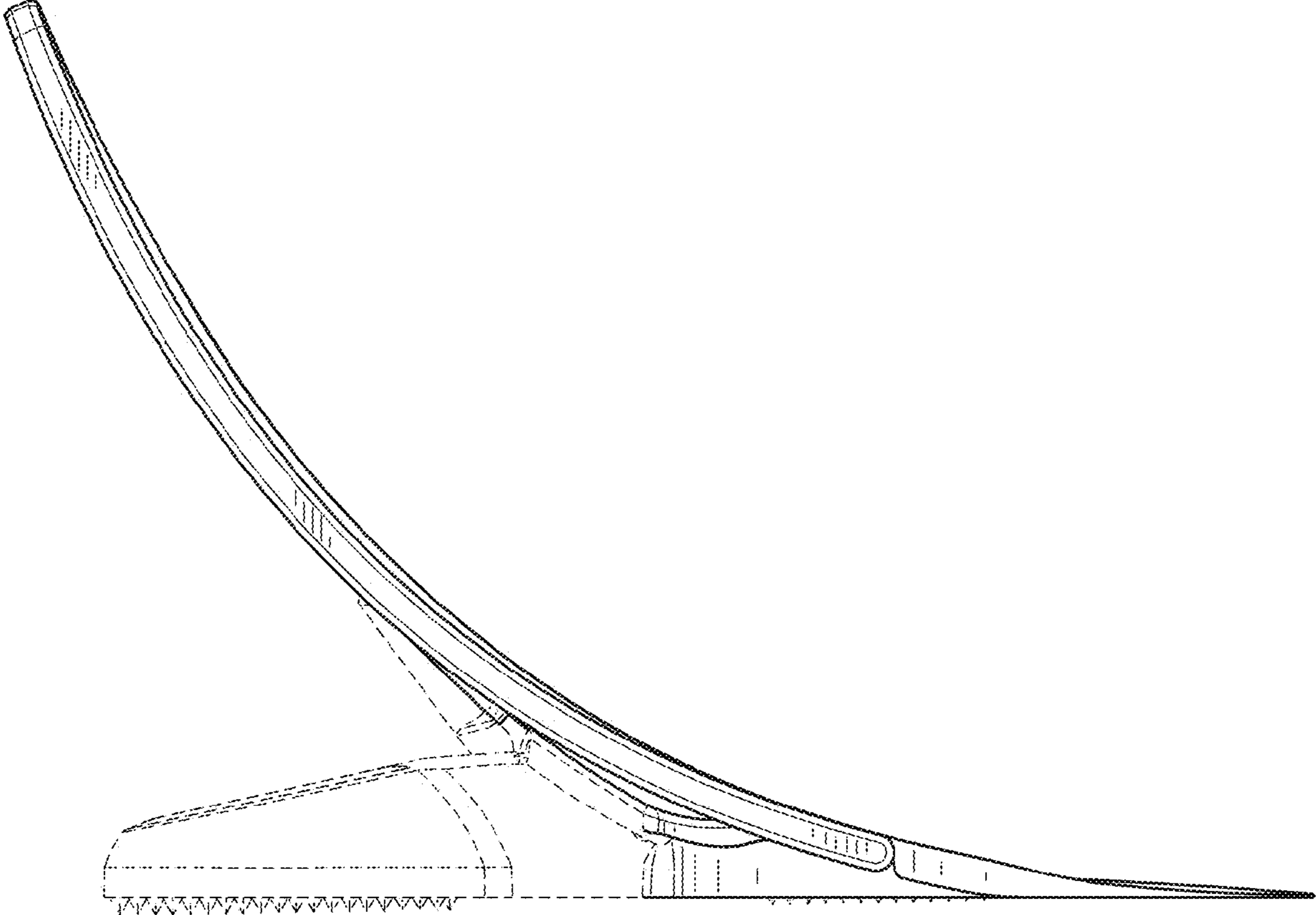

FIG. 6

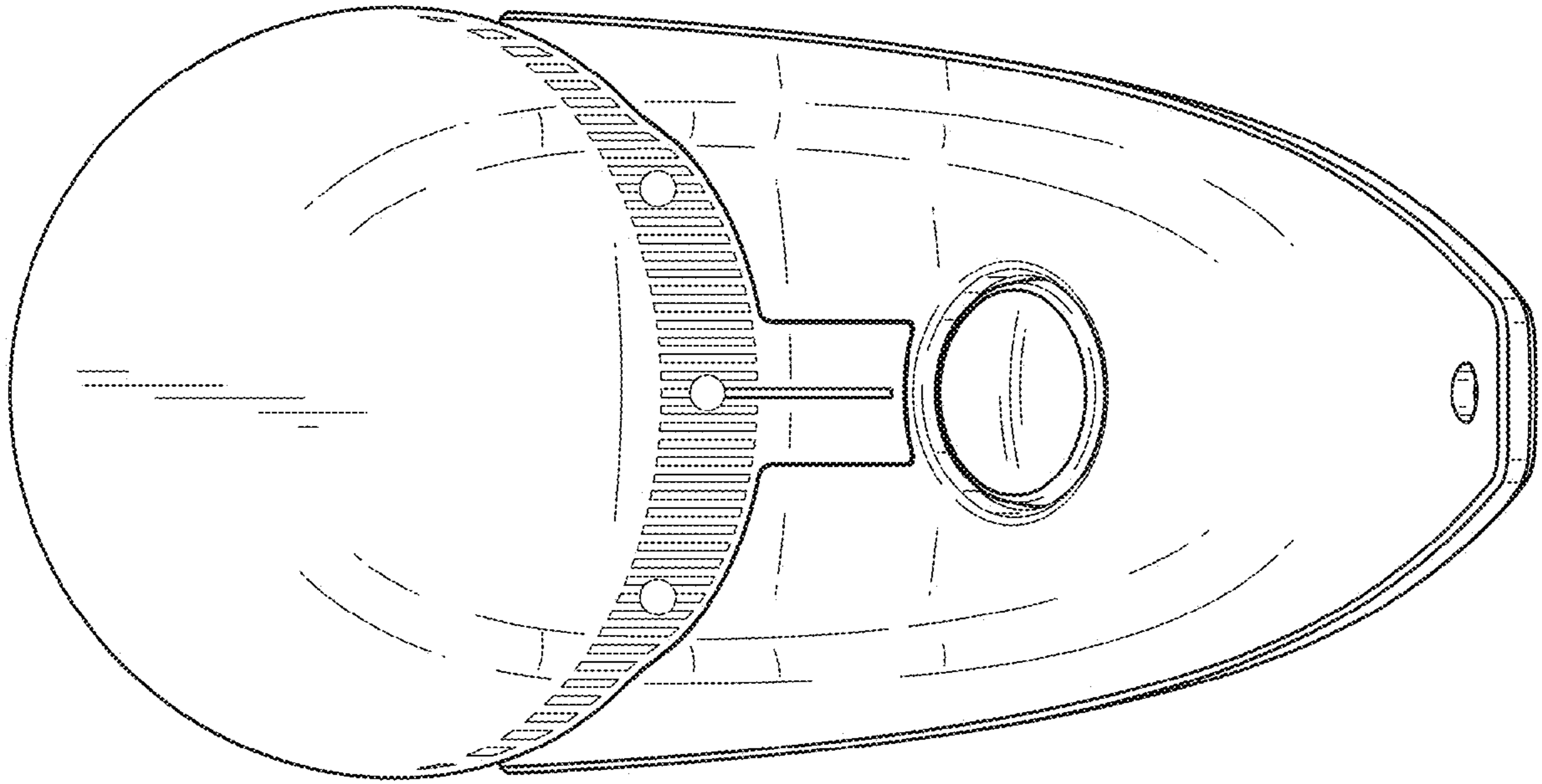

FIG. 7

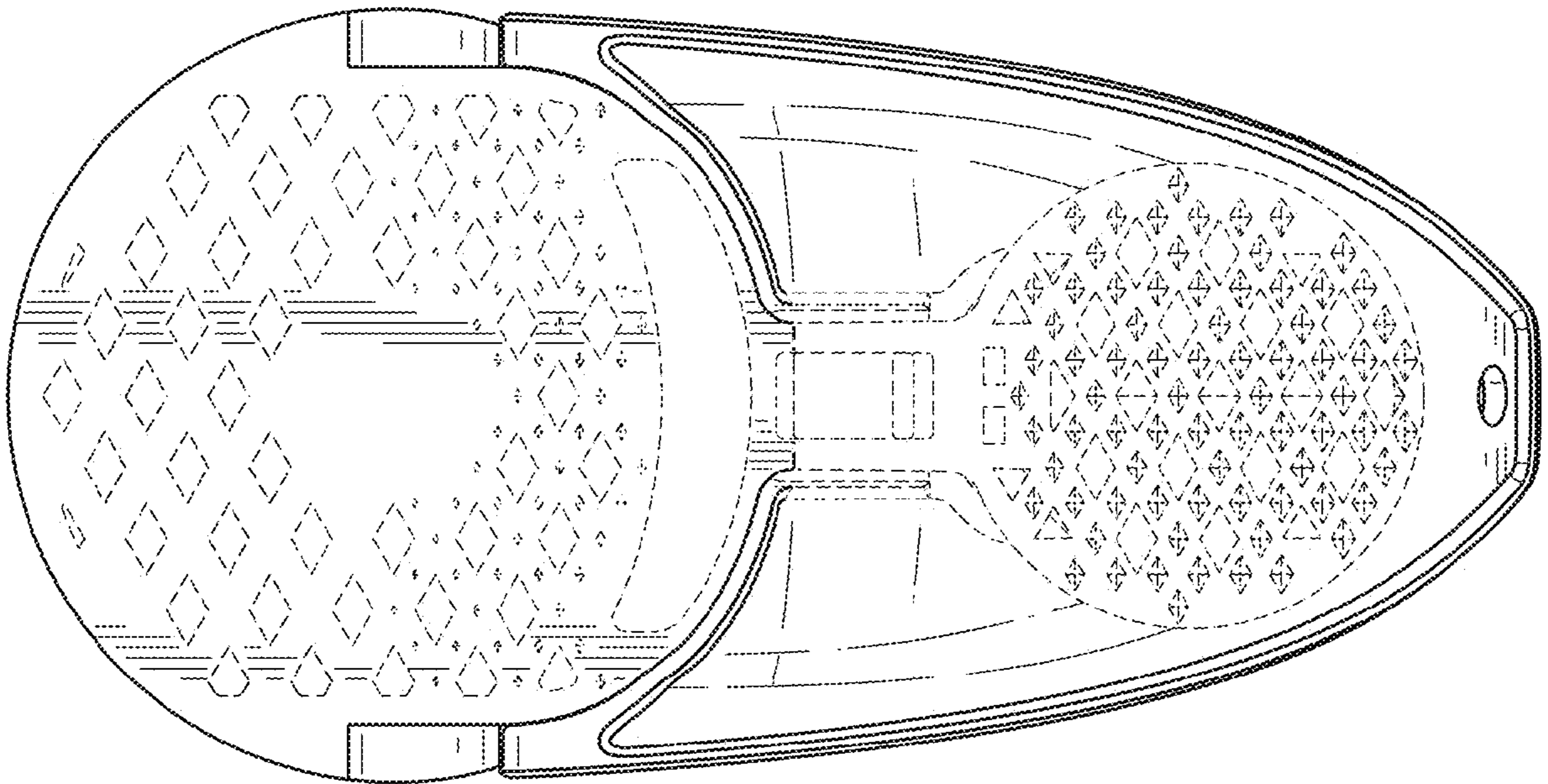

FIG. 8

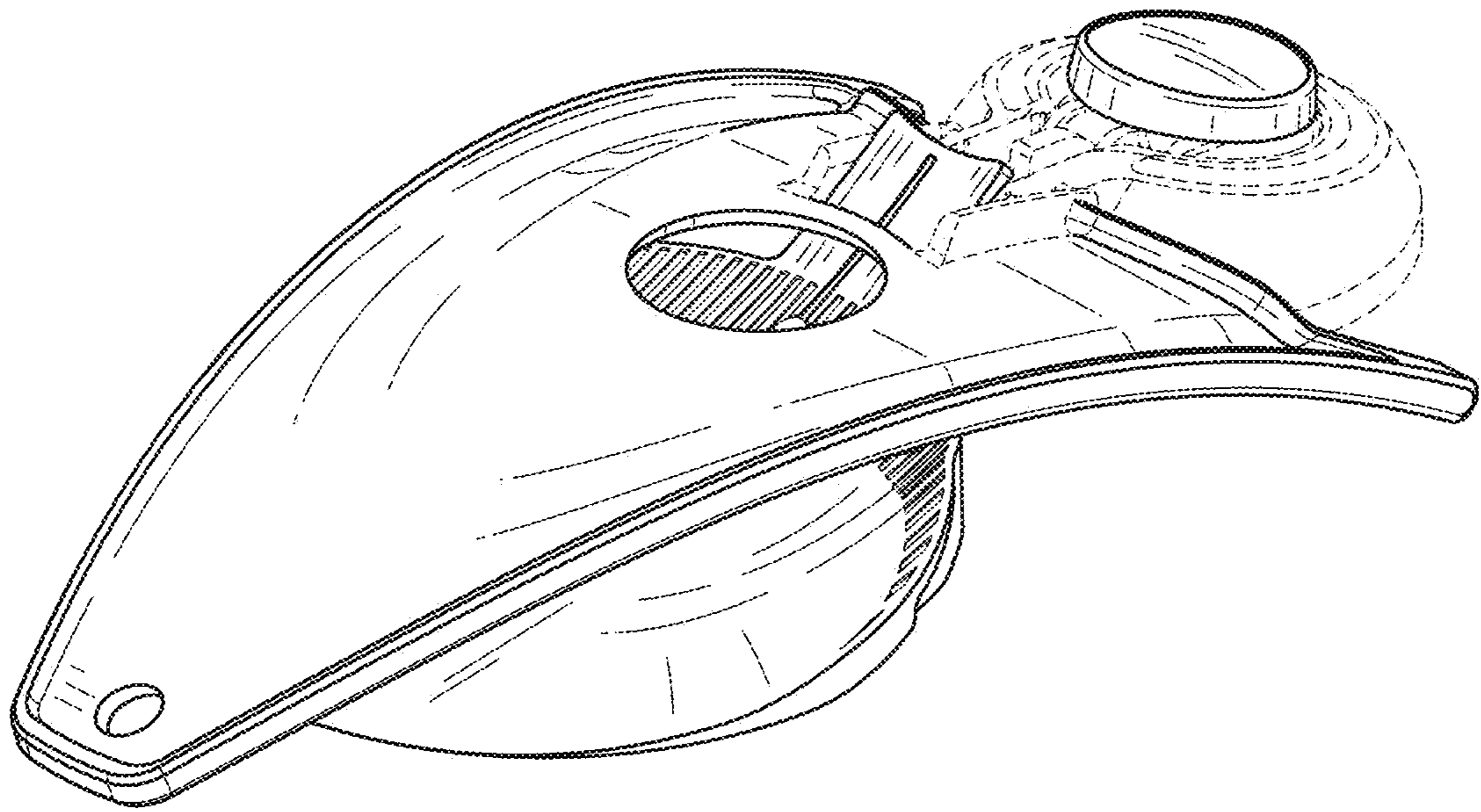

FIG. 9

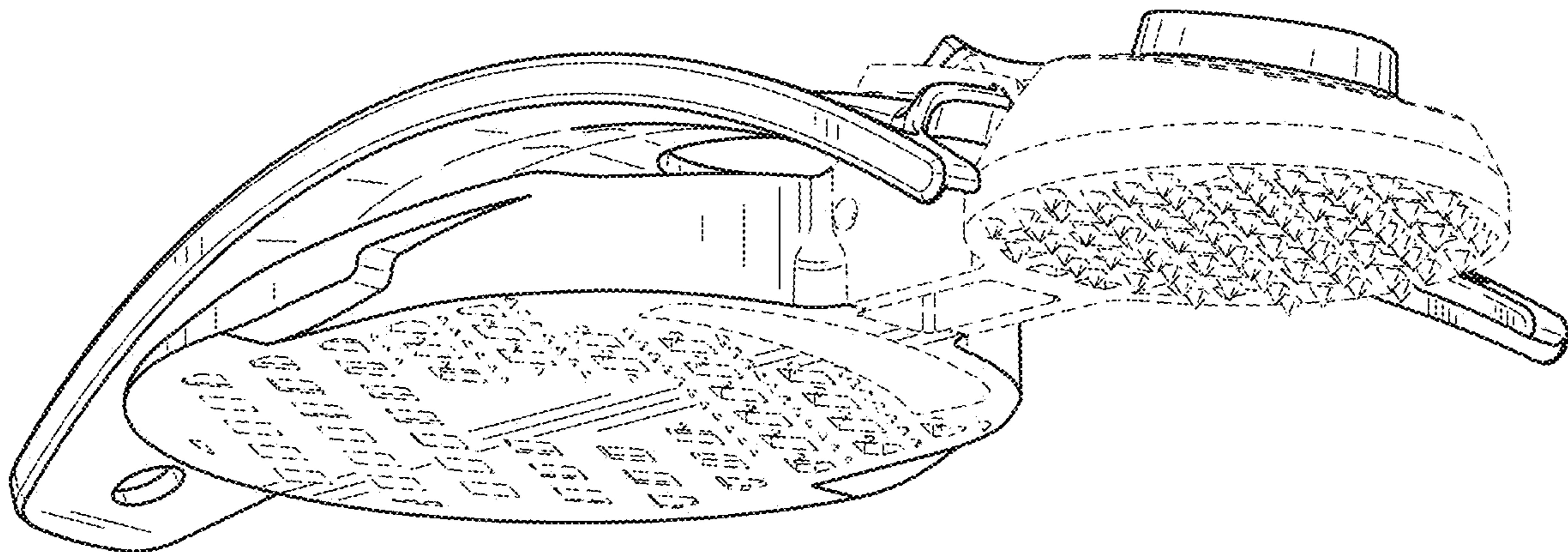

FIG. 10

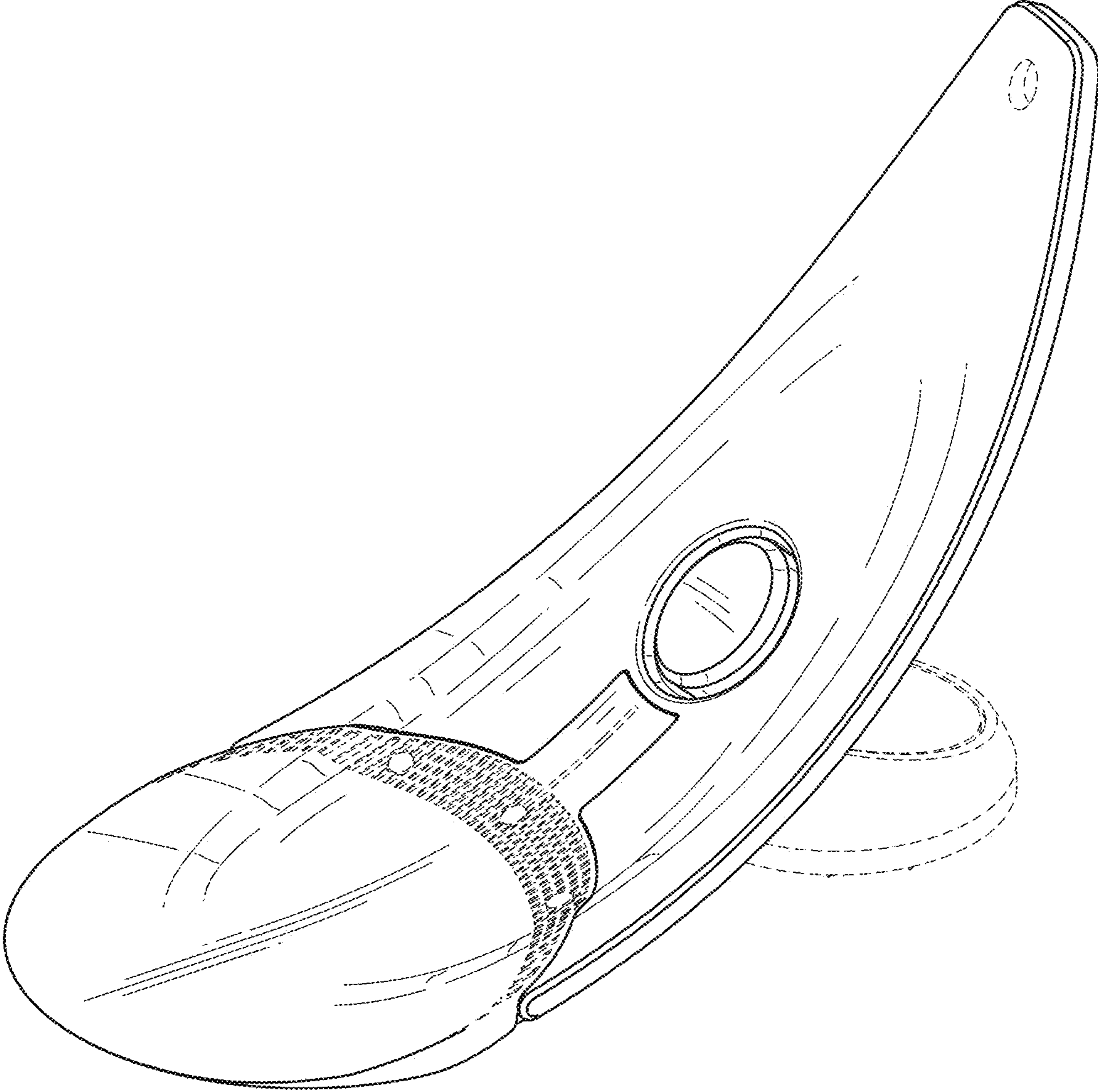

FIG. 11

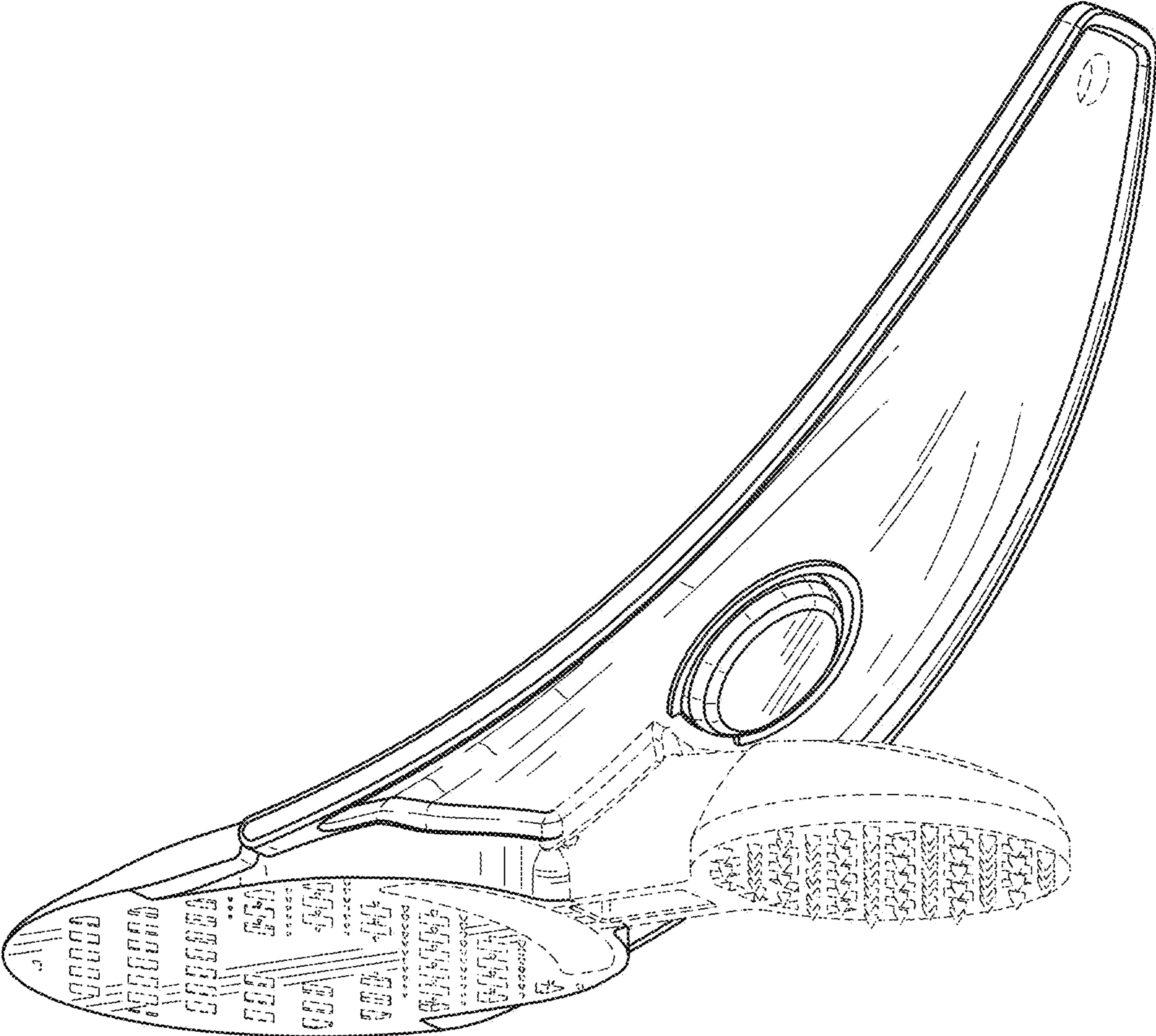

FIG. 12

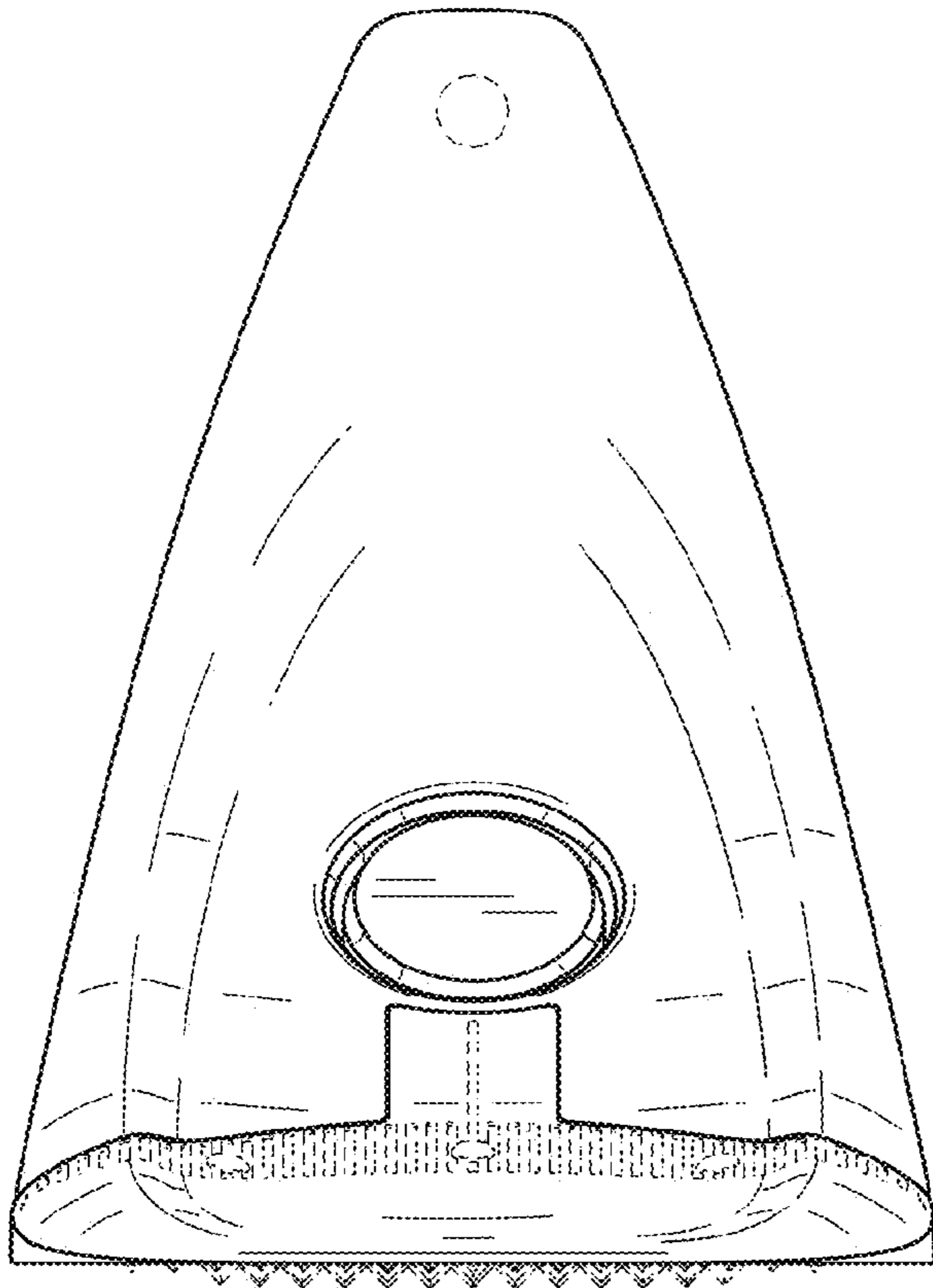

FIG. 13

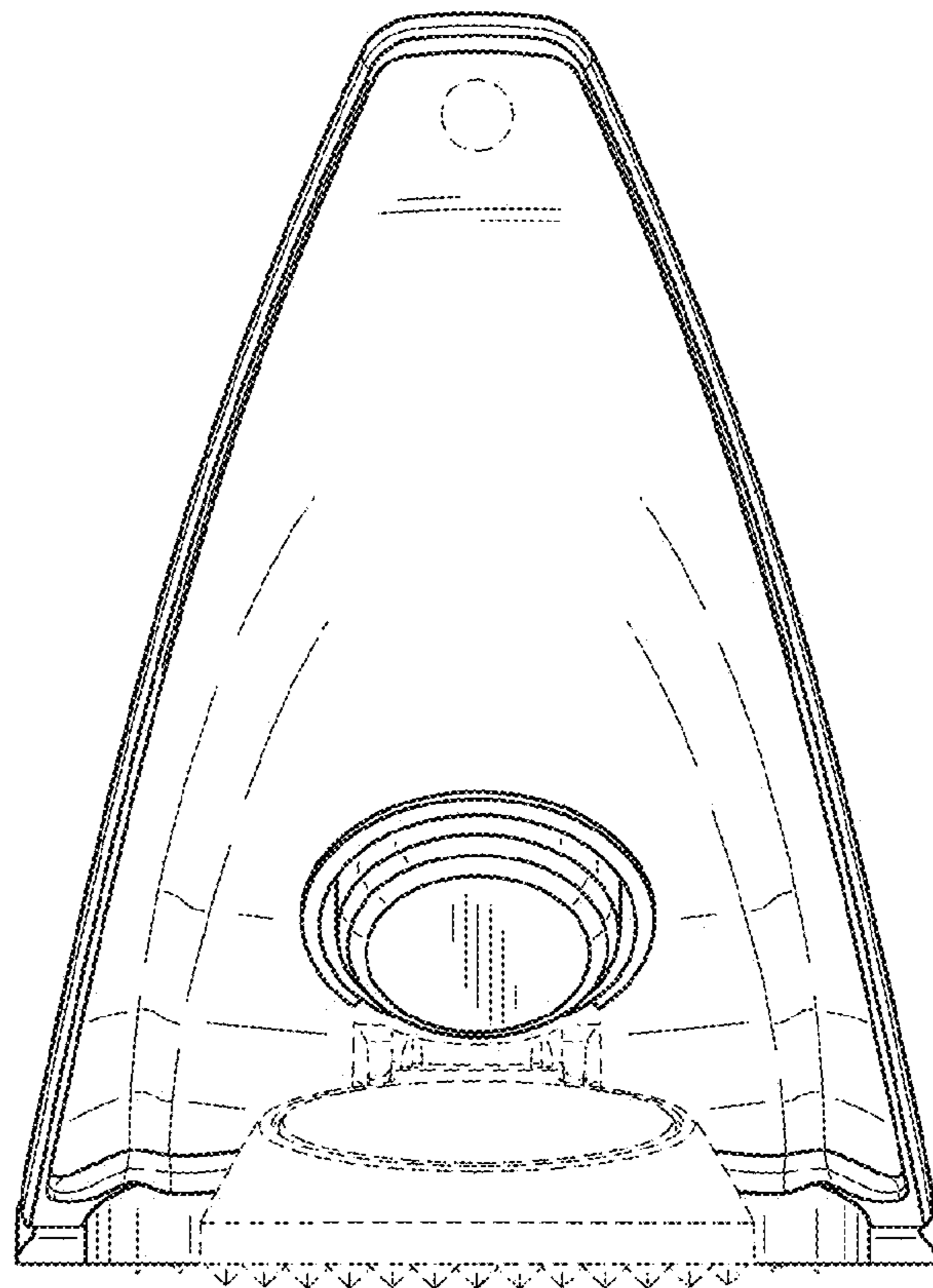

FIG. 14

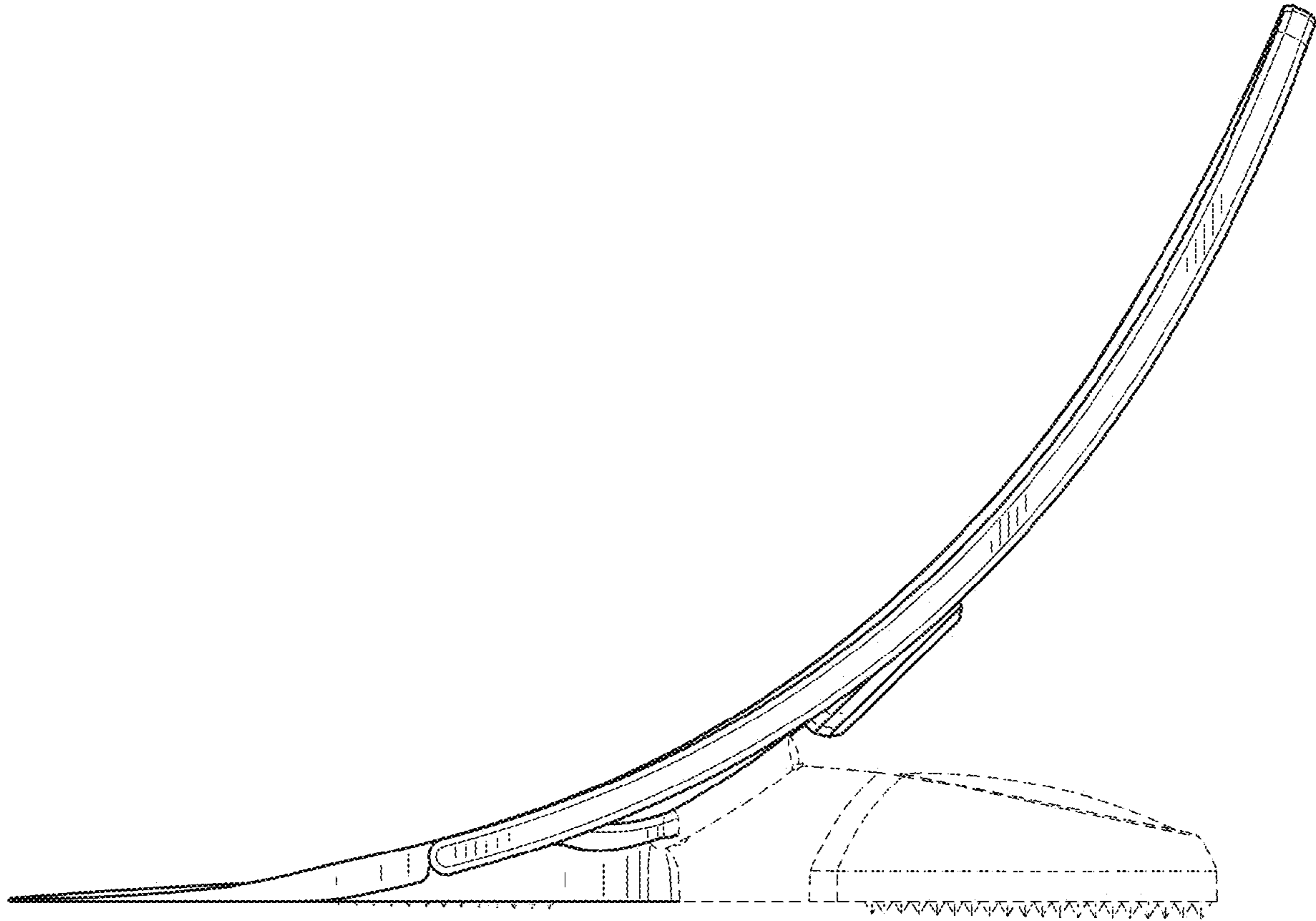

FIG. 15

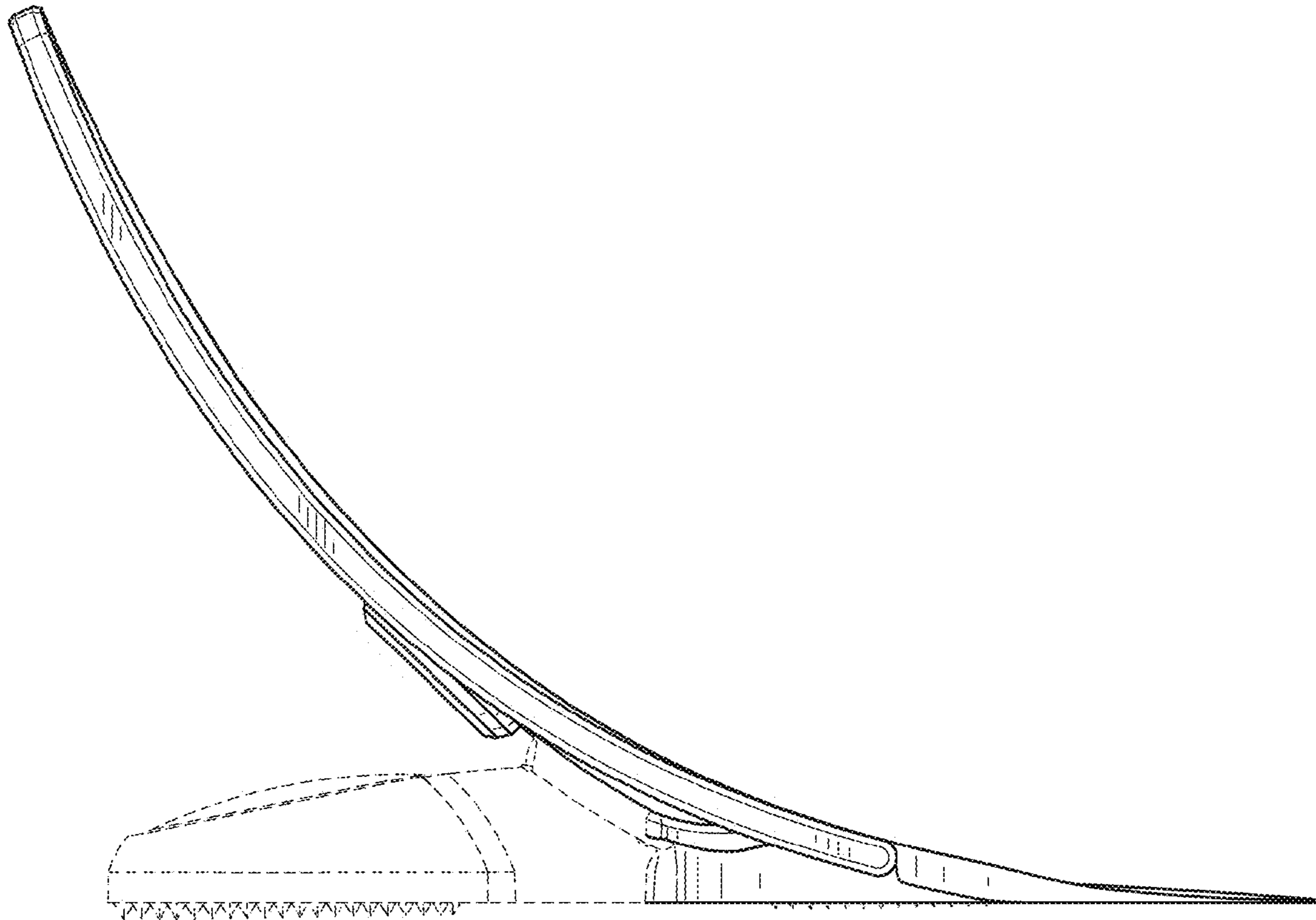

FIG. 16

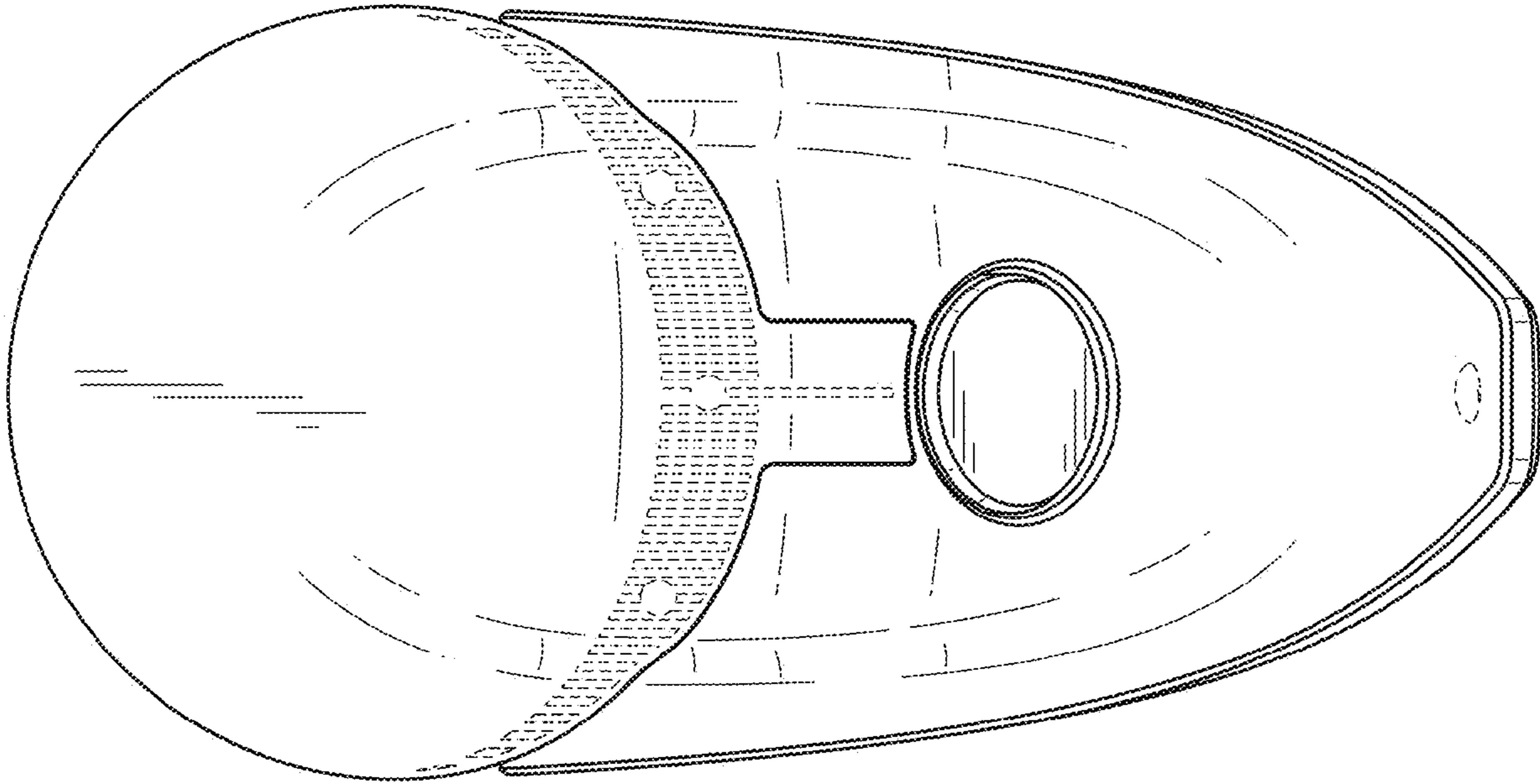

FIG. 17

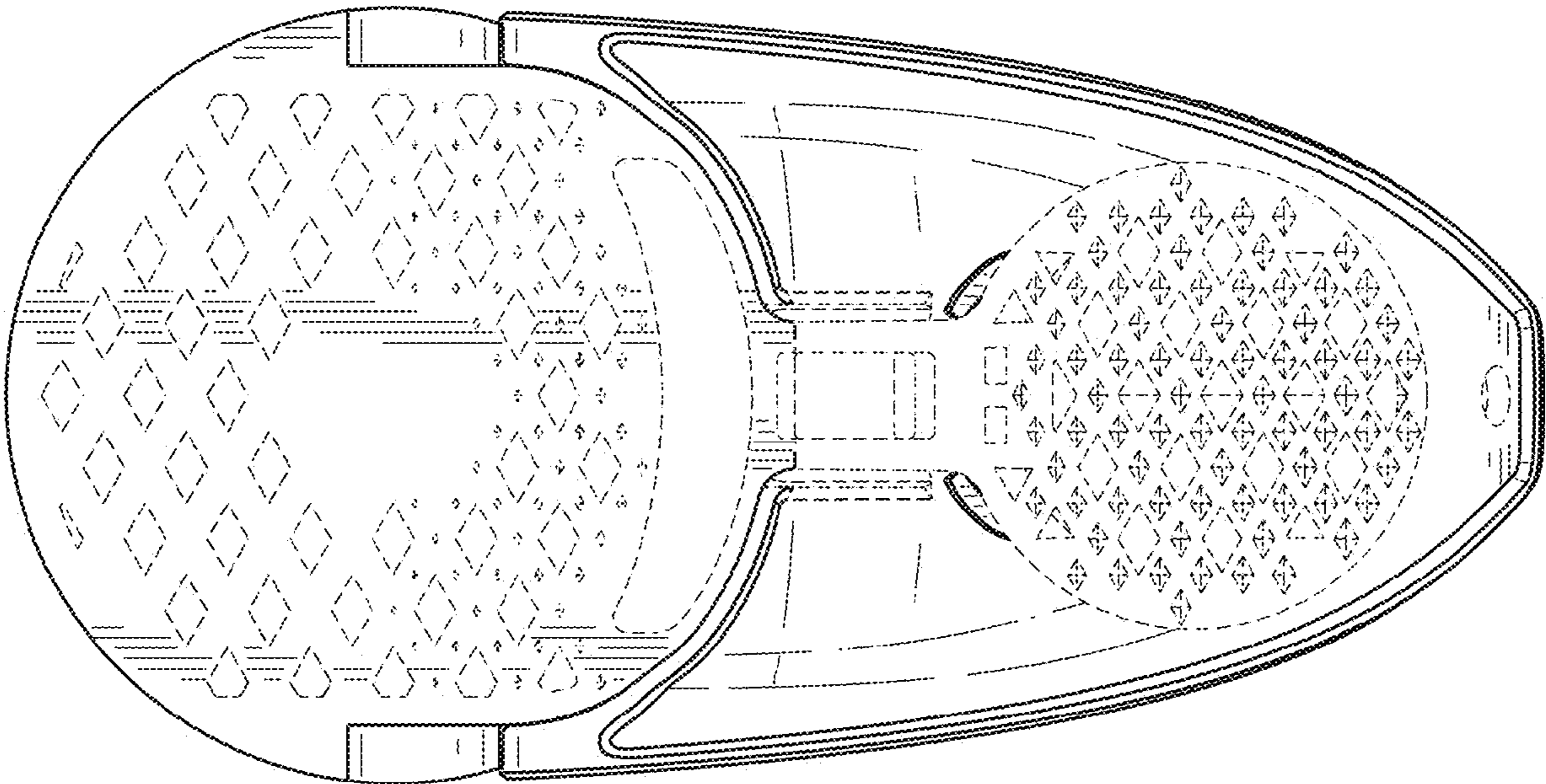

FIG. 18

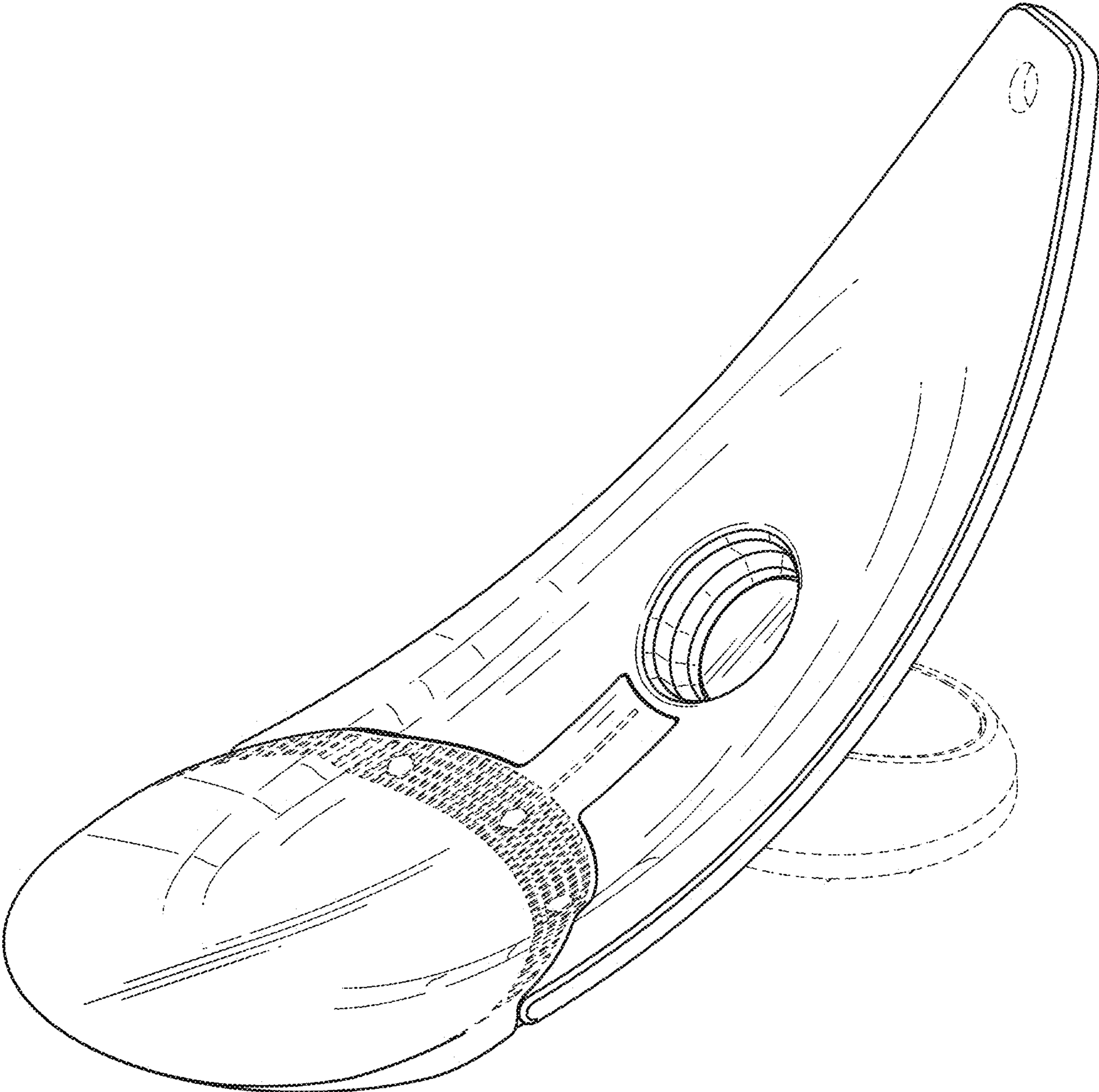

FIG. 19

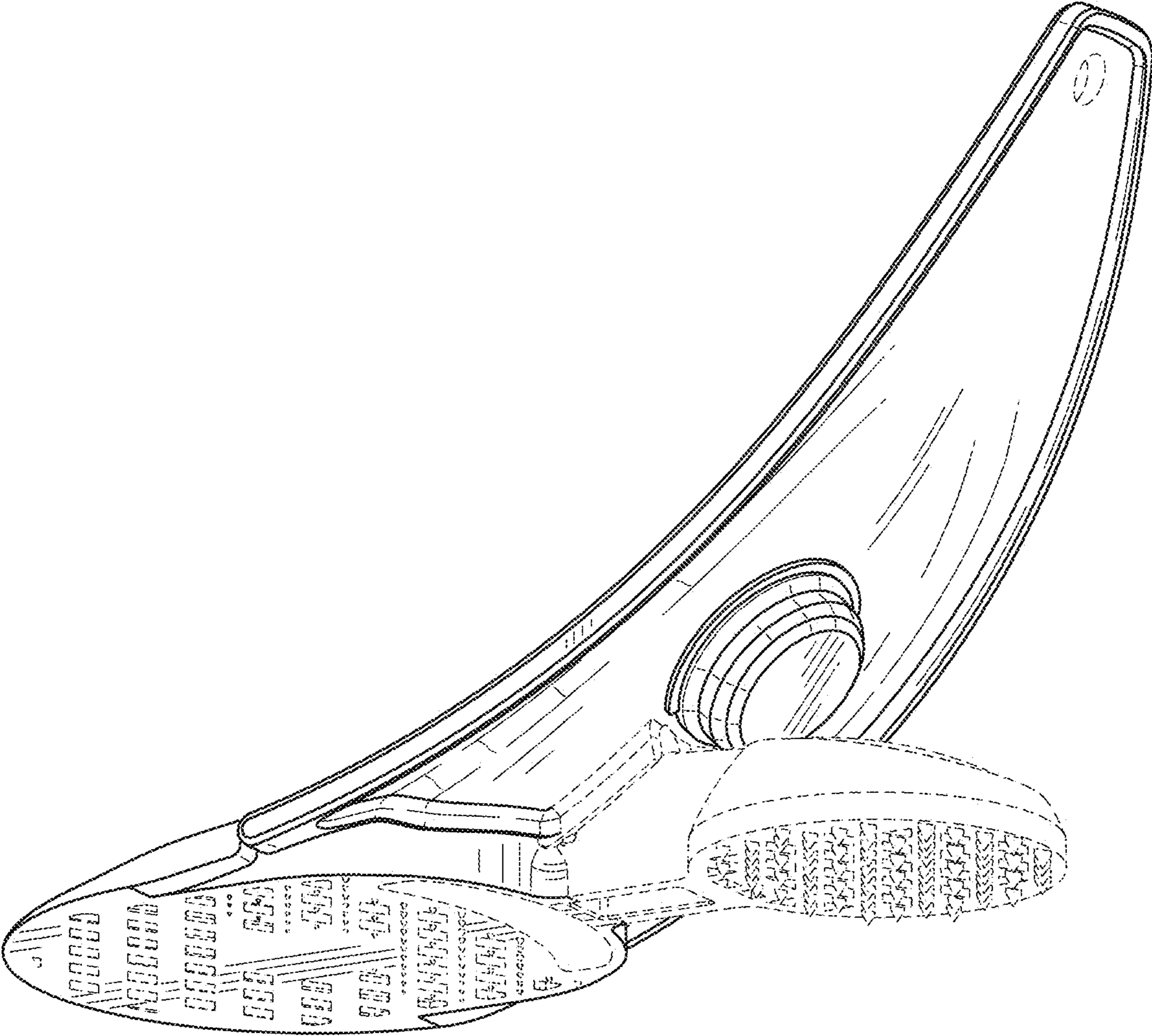

FIG. 20

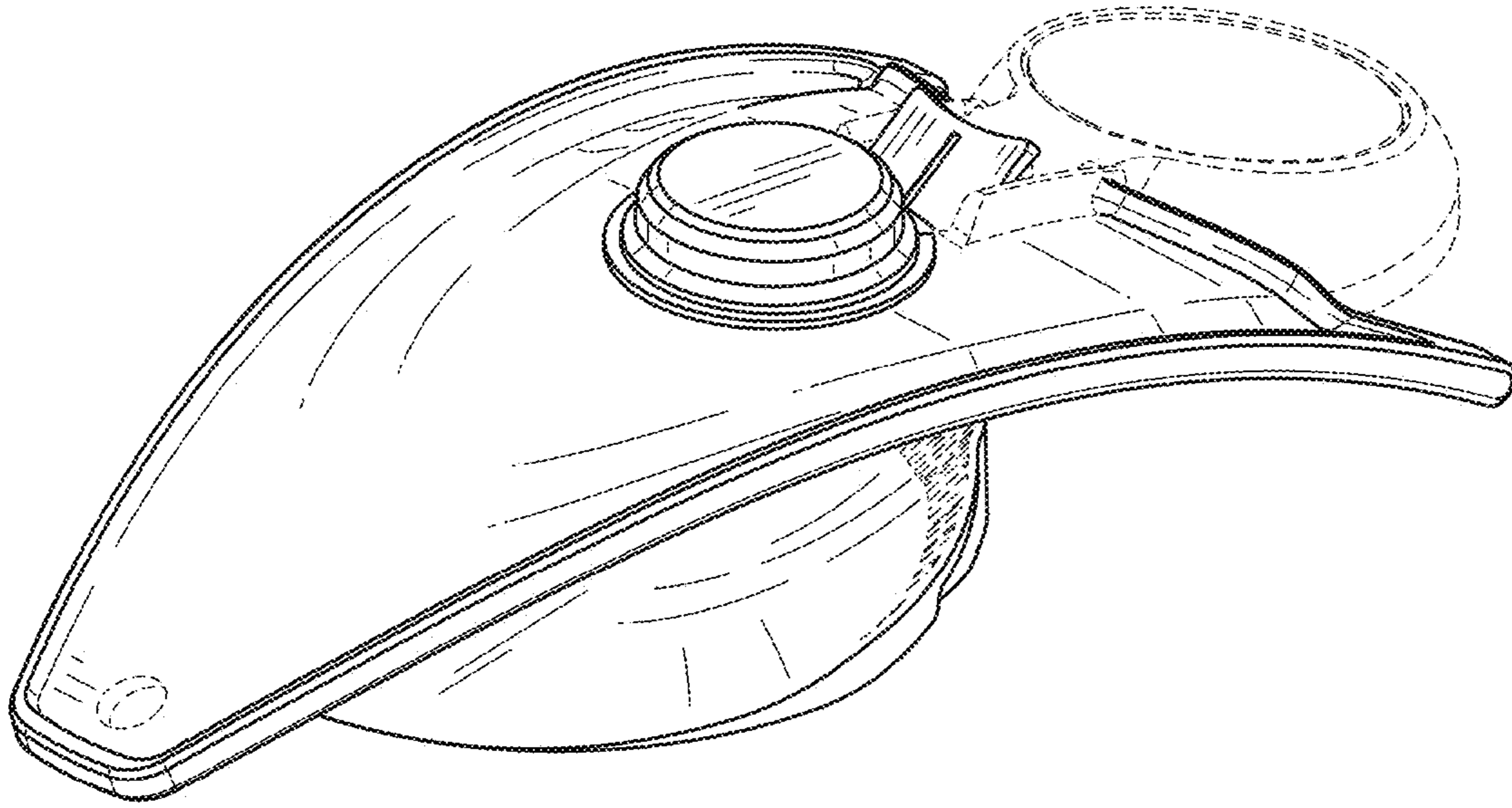

FIG. 21

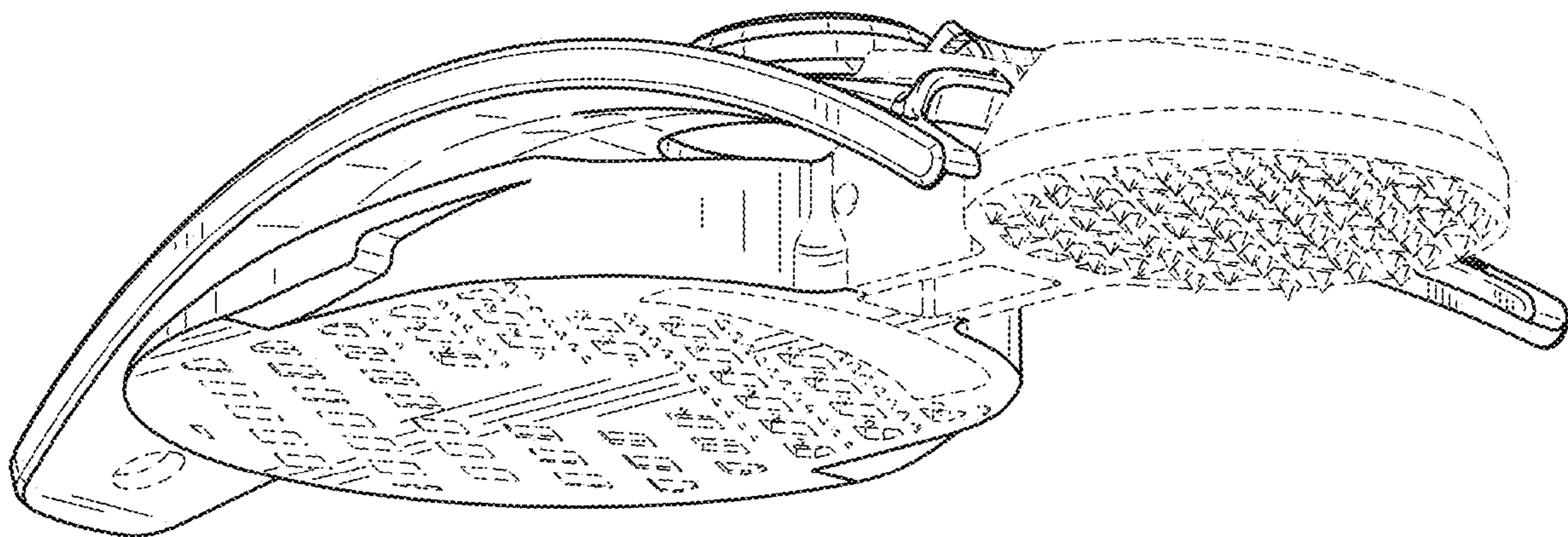

FIG. 22

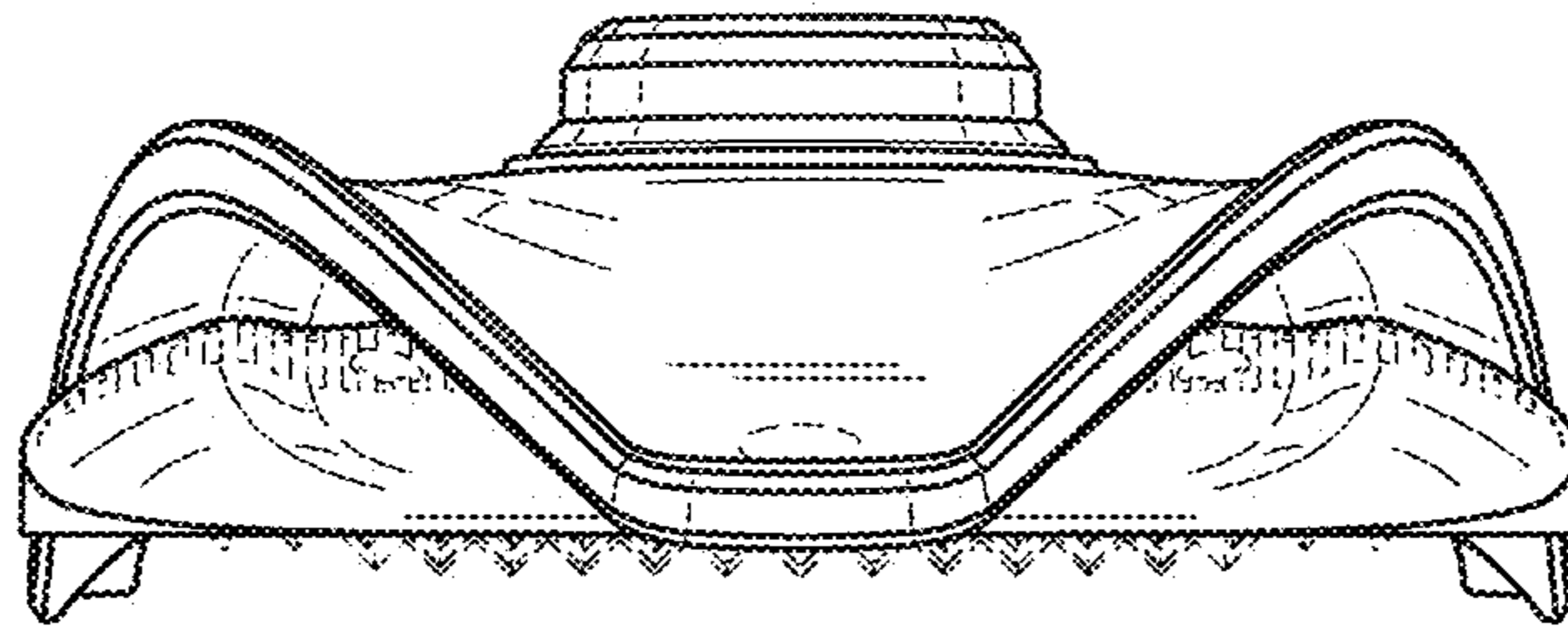

FIG. 23

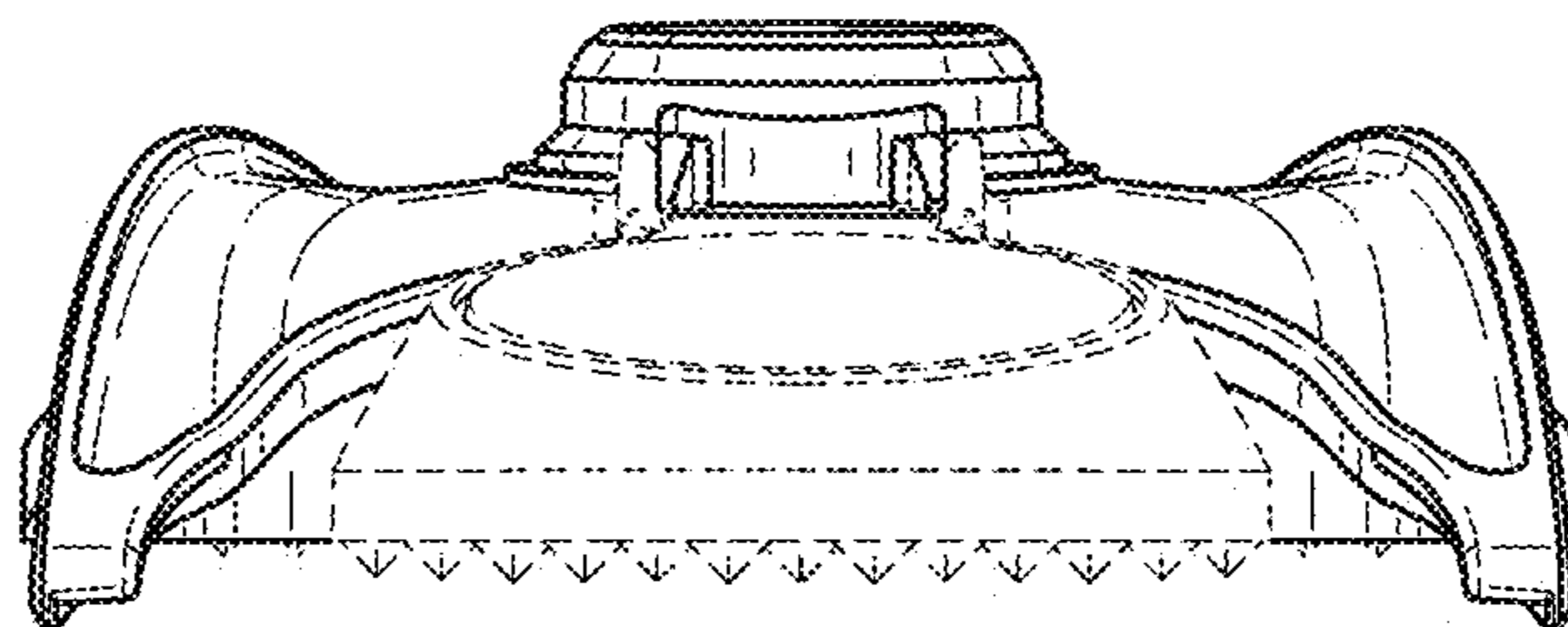

FIG. 24

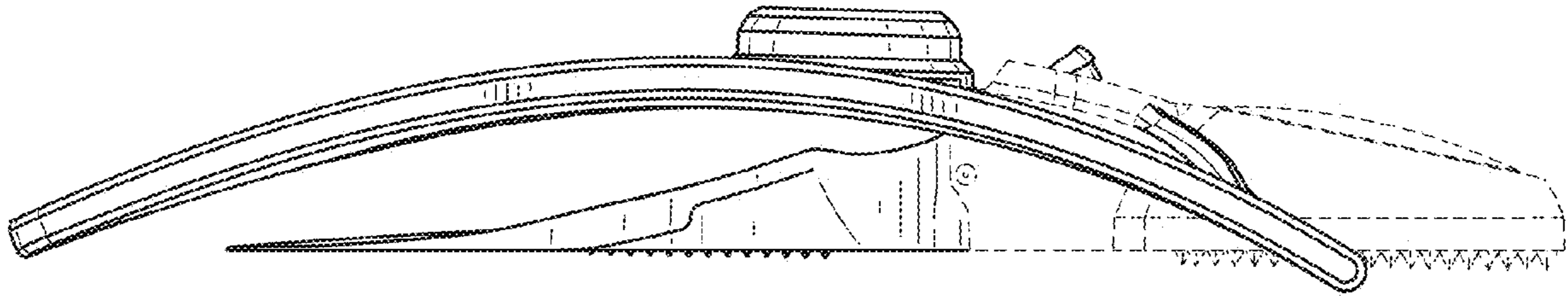

FIG. 25

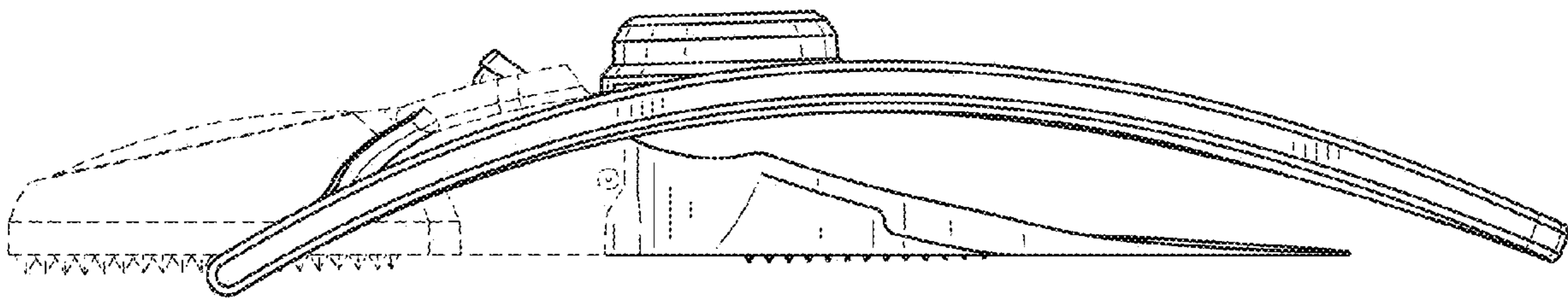

FIG. 26

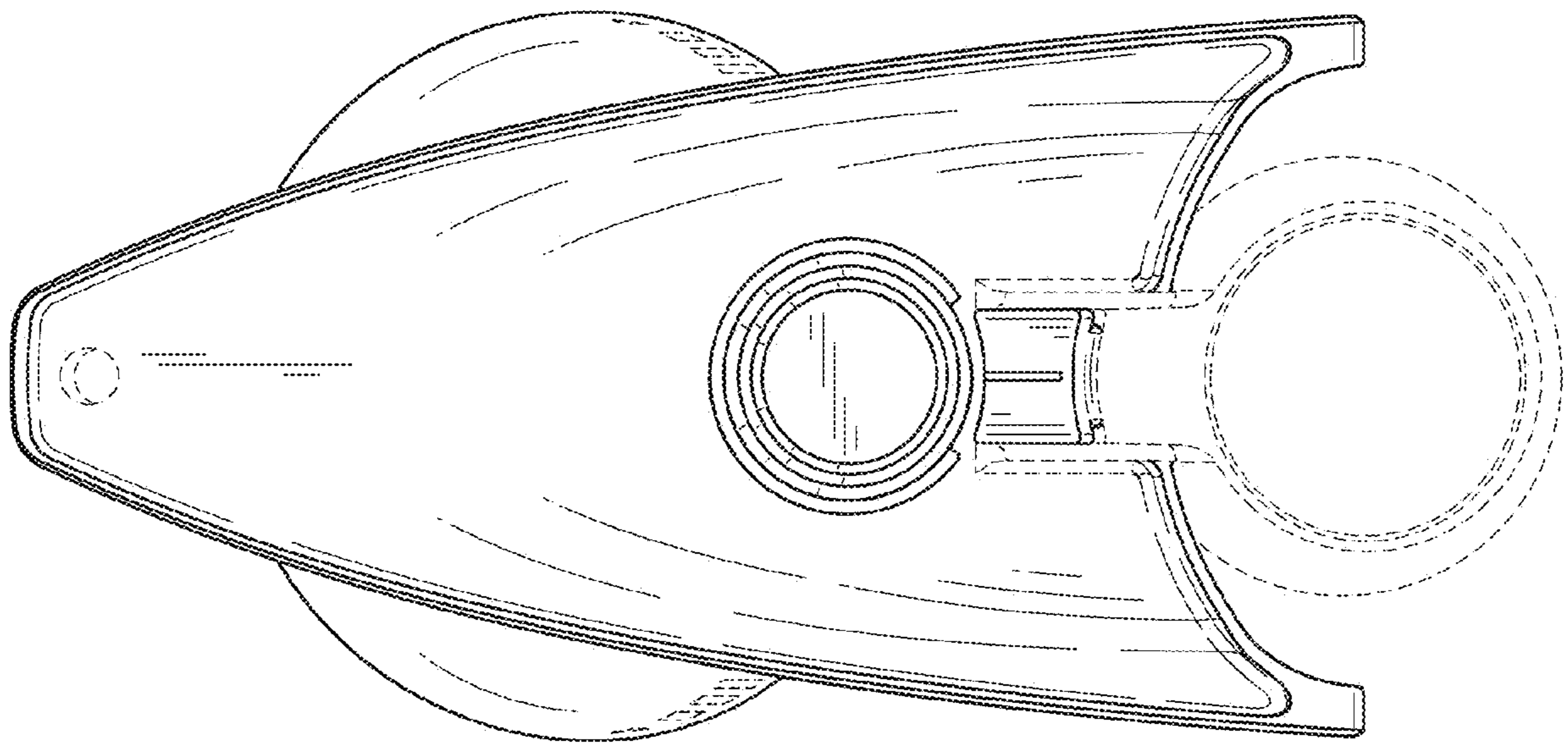

FIG. 27

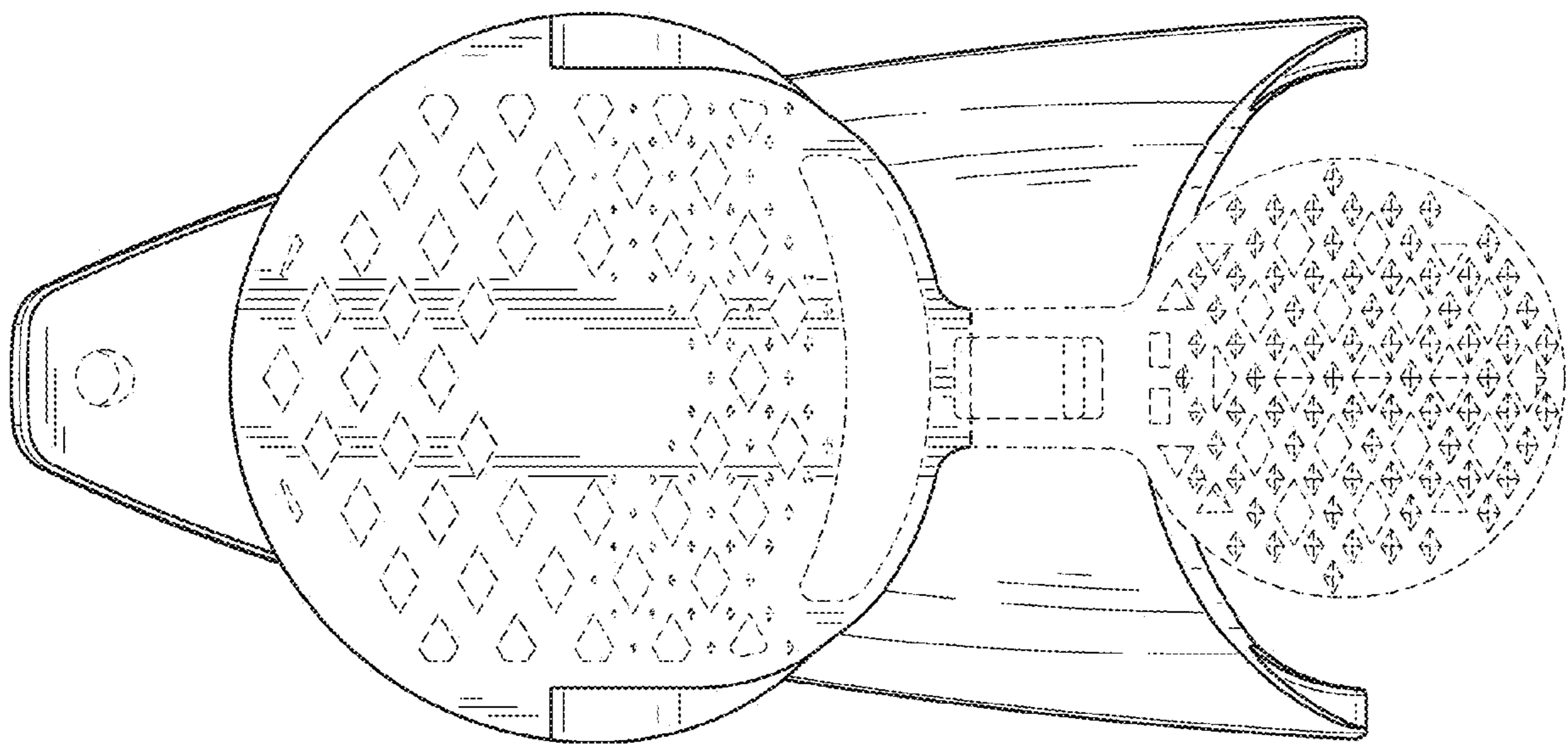

FIG. 28