



US00D956032S

(12) **United States Design Patent**  
**Seo et al.**

(10) **Patent No.:** **US D956,032 S**  
(45) **Date of Patent:** **\*\* Jun. 28, 2022**

(54) **MOBILE PHONE**

FOREIGN PATENT DOCUMENTS

(71) Applicant: **Samsung Electronics Co., Ltd.**,  
Suwon-si (KR)

CN 305956742 \* 7/2020  
CN 306118520 \* 10/2020

(72) Inventors: **Jaehun Seo**, Suwon-si (KR); **Jongdeuk Son**, Suwon-si (KR)

OTHER PUBLICATIONS

(73) Assignee: **SAMSUNG ELECTRONICS CO., LTD.**, Suwon-si (KR)

OnePlus 7—Full phone specifications, announced May 14, 2019 [online], [retrieved Feb. 8, 2022], available at URL: gsmarena.com (Year: 2019).\*

(\*\*) Term: **15 Years**

(Continued)

(21) Appl. No.: **29/707,171**

*Primary Examiner* — Wendy L Arminio

*Assistant Examiner* — Carrie S Gelula

(22) Filed: **Sep. 26, 2019**

(74) *Attorney, Agent, or Firm* — McAndrews Held & Malloy, Ltd.

(30) **Foreign Application Priority Data**

(57) **CLAIM**

Jun. 18, 2019 (KR) ..... 30-2019-0028981

The ornamental design for a mobile phone, as shown and described.

(51) **LOC (13) Cl.** ..... **14-03**

**DESCRIPTION**

(52) **U.S. Cl.**

USPC ..... **D14/248**

(58) **Field of Classification Search**

USPC ..... D14/138 AA, 138 AB, 138 AC, 138 AD,  
D14/138 C, 138 R, 138 G, 214, 248, 250,  
D14/341, 342, 345, 439

CPC ... G06F 1/1626; H04M 1/027; H04M 1/0202;  
H04M 1/0279; H04M 1/0235; H04M  
1/0237; H04M 1/0239; H04M 1/0266;  
H04M 1/0268; H04M 1/0295

See application file for complete search history.

FIG. 1 is a front perspective view of a mobile phone showing our new design;

FIG. 2 is a front elevation view thereof;

FIG. 3 is a rear elevation view thereof;

FIG. 4 is a left side elevation view thereof;

FIG. 5 is a right side elevation view thereof;

FIG. 6 is a top plan view thereof;

FIG. 7 is a bottom plan view thereof;

FIG. 8 is a rear perspective view thereof; and,

FIG. 9 is an enlarged detail view of the encircled portion shown in FIG. 8.

The evenly-spaced dashed broken lines in the figures depict portions of the mobile phone that form no part of the claimed design. The dot-dash broken lines in the drawings represent the bounds of the claim and form no part thereof. The dot-dot-dash broken lines in FIGS. 8 and 9 encircling the portion of the claimed design that is illustrated in enlargement in FIG. 9 form no part of the claimed design.

(56) **References Cited**

U.S. PATENT DOCUMENTS

D783,567 S \* 4/2017 Park ..... D14/138 G  
D831,605 S \* 10/2018 Baik ..... D14/138 G  
D839,848 S \* 2/2019 Baik ..... D14/341  
D841,001 S \* 2/2019 Akana ..... D14/341  
D864,141 S \* 10/2019 Kim ..... D14/138 G

(Continued)

**1 Claim, 7 Drawing Sheets**

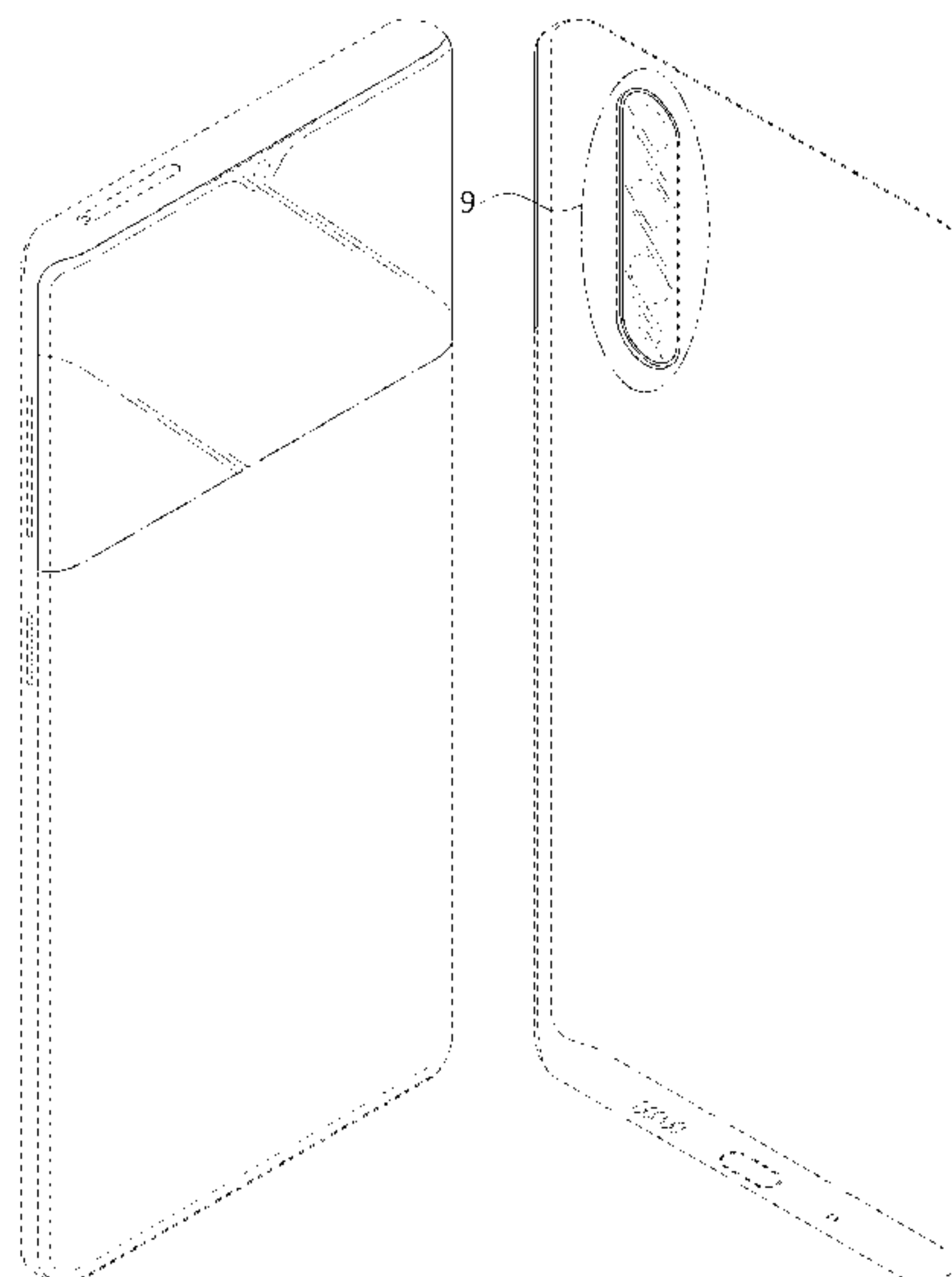

(56)

References Cited

U.S. PATENT DOCUMENTS

D872,044 S \* 1/2020 Lee ..... D14/138 G  
 D876,384 S \* 2/2020 Park ..... D14/138 G  
 D881,863 S \* 4/2020 Song ..... D14/248  
 D892,782 S \* 8/2020 Liu ..... D14/248  
 D900,775 S \* 11/2020 Kwon ..... D14/138 G  
 D904,993 S \* 12/2020 Xu ..... D14/138 G  
 D910,610 S \* 2/2021 Seo ..... D14/248  
 D911,997 S \* 3/2021 Seo ..... D14/138 G  
 D911,998 S \* 3/2021 Seo ..... D14/138 G  
 D914,632 S \* 3/2021 Kim ..... D14/138 G  
 D915,321 S \* 4/2021 Xu ..... D14/138 G  
 D922,992 S \* 6/2021 Seo ..... D14/248  
 D924,191 S \* 7/2021 Seo ..... D14/138 G  
 D924,192 S \* 7/2021 Seo ..... D14/138 G  
 D924,193 S \* 7/2021 Ryu ..... D14/138 G  
 D924,194 S \* 7/2021 Ryu ..... D14/138 G  
 D924,195 S \* 7/2021 Son ..... D14/138 G  
 D924,216 S \* 7/2021 Ryu ..... D14/248  
 D924,217 S \* 7/2021 Ryu ..... D14/248  
 D924,219 S \* 7/2021 Son ..... D14/248  
 D924,829 S \* 7/2021 Ryu ..... D14/138 G

D924,830 S \* 7/2021 Son ..... D14/138 G  
 D925,486 S \* 7/2021 Seo ..... D14/138 G  
 D929,357 S \* 8/2021 Guo ..... D14/138 G  
 D936,628 S \* 11/2021 Liu ..... D14/138 G  
 D938,404 S \* 12/2021 Seo ..... D14/248  
 D939,484 S \* 12/2021 Son ..... D14/248

OTHER PUBLICATIONS

Realme 5—Full phone specifications, announced Aug. 20, 2019 [online], [retrieved Feb. 8, 2022], available at URL: [gsmarena.com](http://gsmarena.com) (Year: 2019).\*

Vivo Z1x—Full phone specifications, announced Sep. 2019 [online], [retrieved Feb. 8, 2022], available at URL: [gsmarena.com](http://gsmarena.com) (Year: 2019).\*

Vivo U20—Full phone specifications, announced Nov. 2019 [online], [retrieved Feb. 8, 2022], available at URL: [gsmarena.com](http://gsmarena.com) (Year: 2019).\*

Oppo A91—Full phone specifications, announced Dec. 20, 2019 [online], [retrieved Feb. 8, 2022], available at URL: [gsmarena.com](http://gsmarena.com) (Year: 2019).\*

\* cited by examiner

FIG. 1

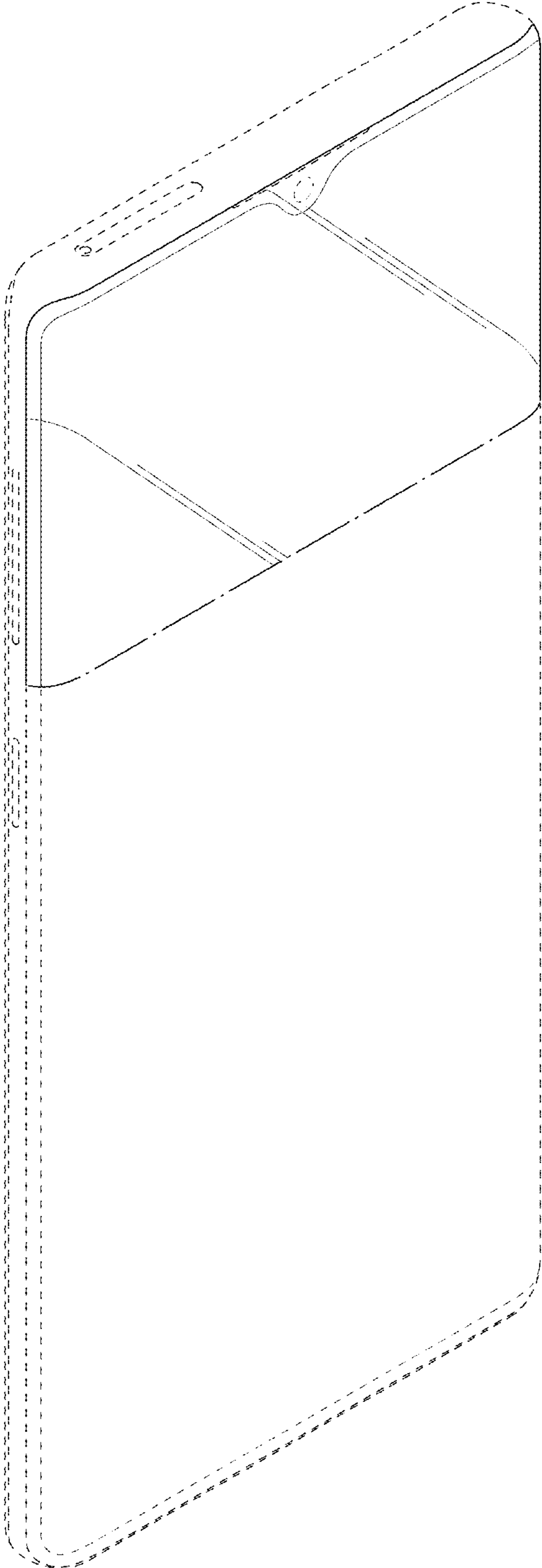

FIG. 2

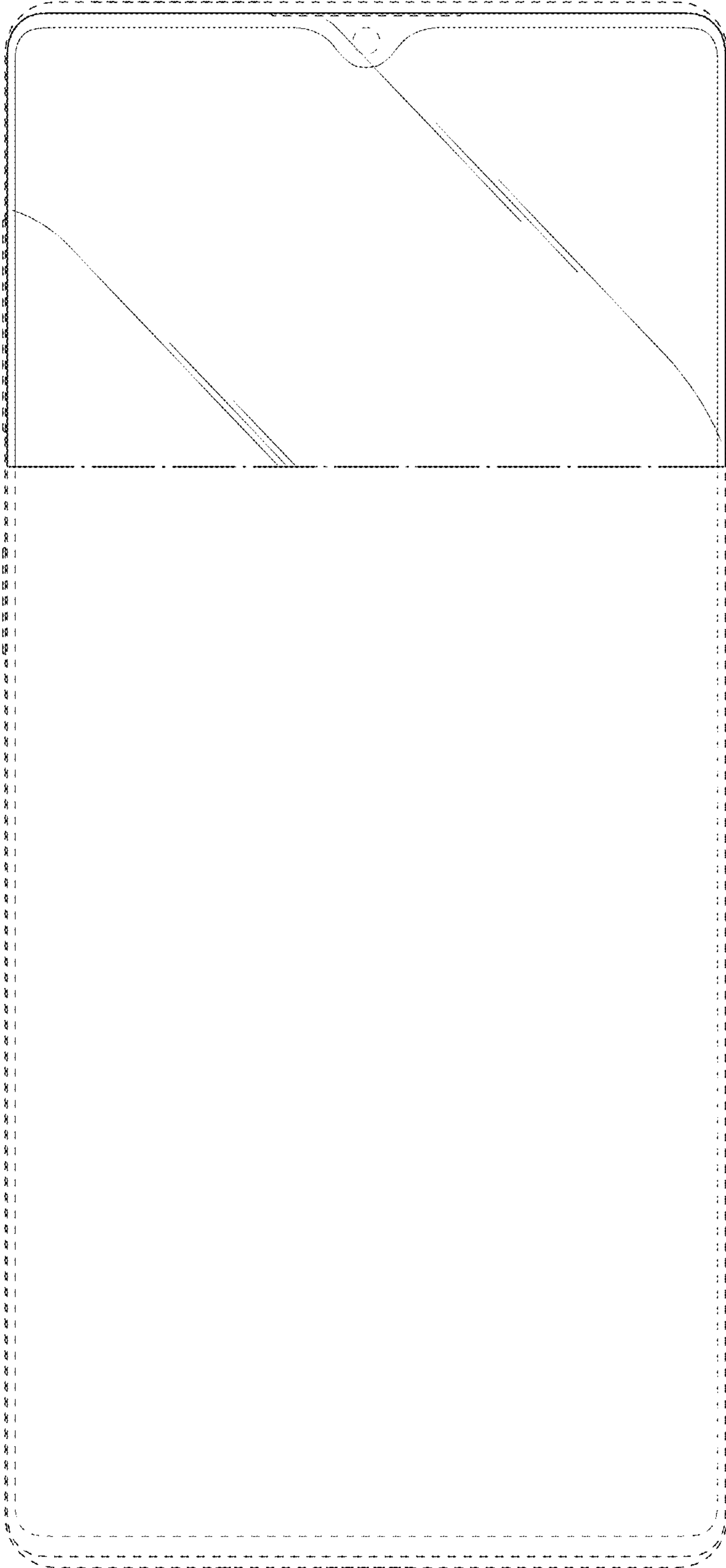

FIG. 3

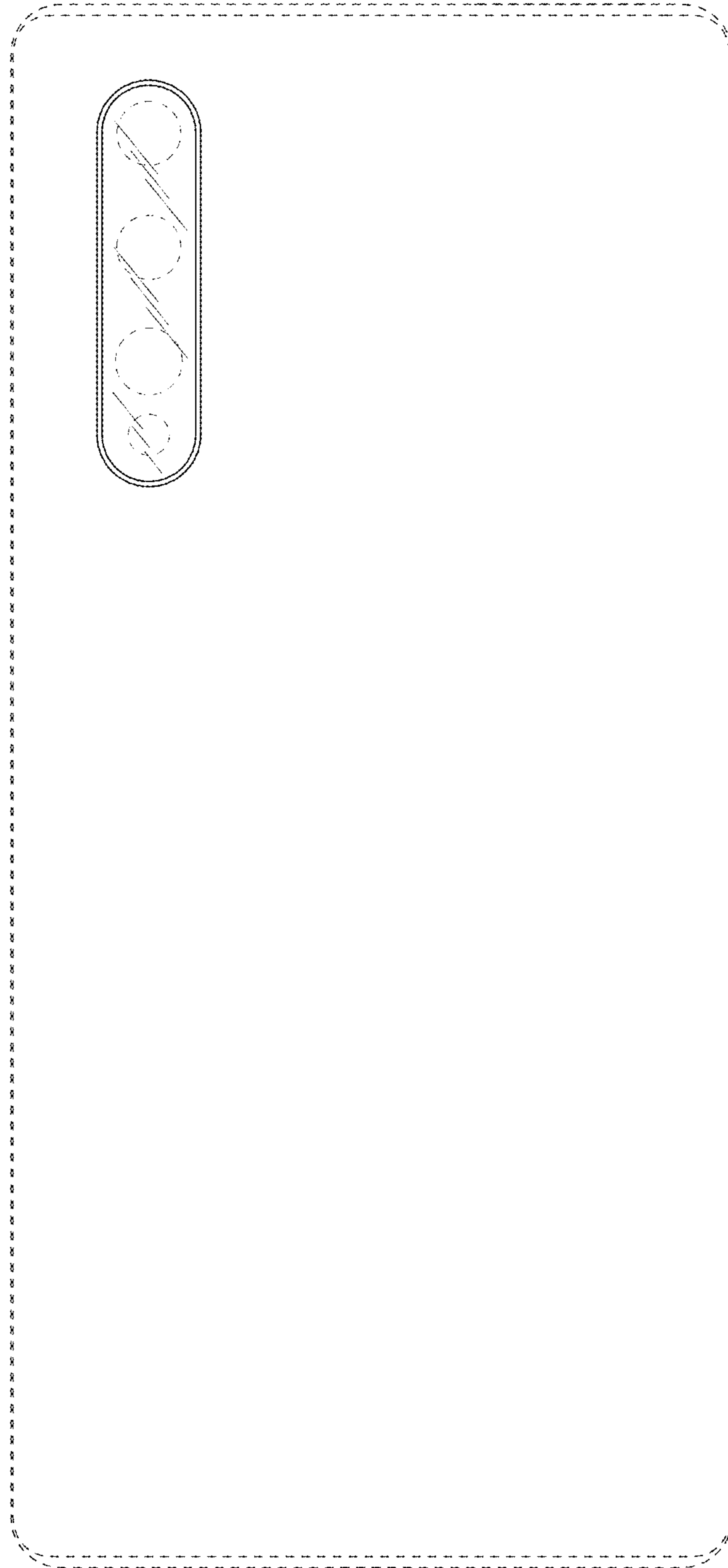

FIG. 4

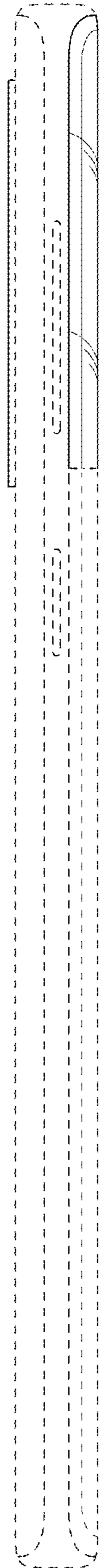

FIG. 5

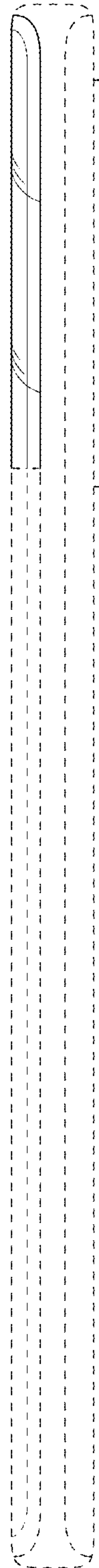

FIG. 6

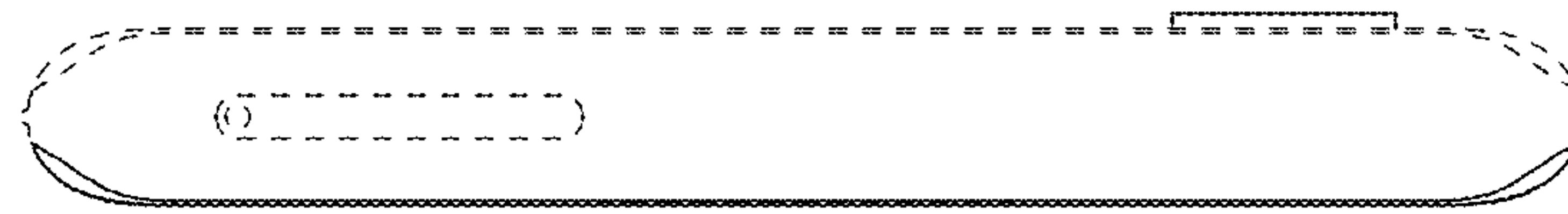

FIG. 7

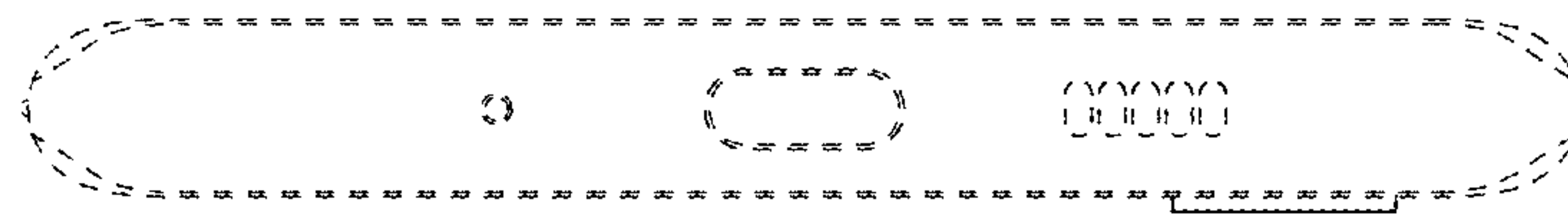



FIG. 8

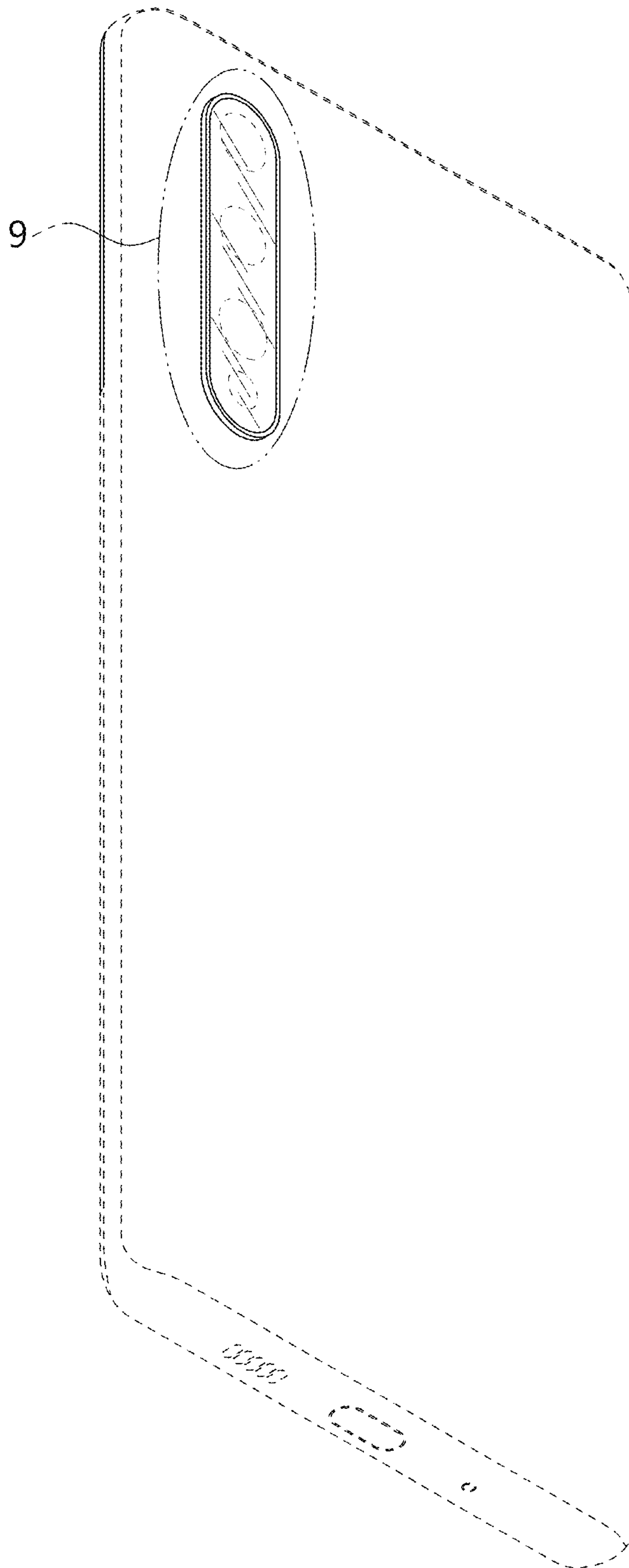



FIG. 9

