



US00D955918S

(12) **United States Design Patent**  
**Frazier**

(10) **Patent No.:** **US D955,918 S**  
(45) **Date of Patent:** **\*\* Jun. 28, 2022**

- (54) **HANGING PLANTER**
- (71) Applicant: **Susan L. Frazier**, Lakewood, OH (US)
- (72) Inventor: **Susan L. Frazier**, Lakewood, OH (US)
- (\*\*) Term: **15 Years**
- (21) Appl. No.: **29/652,594**
- (22) Filed: **Sep. 28, 2020**
- (51) **LOC (13) Cl.** ..... **11-02**
- (52) **U.S. Cl.**  
USPC ..... **D11/148**
- (58) **Field of Classification Search**  
USPC ..... D11/143–156, 164; D6/403–405,  
D6/556–558  
CPC . A01G 9/02; A01G 9/021; A01G 9/04; A01G  
27/003; A01G 31/06  
See application file for complete search history.

D837,094	S *	1/2019	Hung	.....	D11/152
D862,282	S *	10/2019	Hung	.....	D11/152
10,450,128	B2 *	10/2019	Hung	.....	B65D 5/5021
D877,652	S *	3/2020	Hung	.....	D11/152
10,813,304	B2 *	10/2020	Marshall	.....	A01G 13/0281
D908,039	S *	1/2021	Hung	.....	D11/152
2002/0104263	A1 *	8/2002	Chang	.....	A01G 9/021 47/65.7
2003/0209552	A1 *	11/2003	Leibner	.....	G07D 9/002 220/628
2005/0072704	A1 *	4/2005	Patz	.....	B65D 5/5286 206/418
2010/0212222	A1 *	8/2010	Gallo	.....	A01G 13/0281 47/21.1
2013/0036669	A1 *	2/2013	Rabii	.....	A01G 31/02 47/62 R

\* cited by examiner

*Primary Examiner* — Elizabeth A. Albert

(57) **CLAIM**

The ornamental design for a hanging planter, as shown and described.

(56) **References Cited**

U.S. PATENT DOCUMENTS

1,059,359	A *	4/1913	Hahn	.....	B65D 85/321 217/26
1,625,620	A *	4/1927	Maston	.....	B65D 85/32 229/120.32
D232,283	S *	8/1974	Wagschal	.....	47/67
D238,088	S *	12/1975	Grosfillex	.....	D11/155
4,113,093	A *	9/1978	Hendrickx	.....	B65D 81/36 47/84
D469,930	S *	2/2003	Bloedorn	.....	D30/124
6,564,745	B1 *	5/2003	Bloedorn	.....	A01K 39/014 119/57.8
D558,085	S *	12/2007	Jenkins	.....	D11/148
D638,262	S *	5/2011	Eberstadt, Jr.	.....	D7/554.2
D661,222	S *	6/2012	Jaworski	.....	D11/143
D661,223	S *	6/2012	Jaworski	.....	D11/143

**DESCRIPTION**

FIG. 1 is a top perspective view showing the new design.  
 FIG. 2 is a front view thereof.  
 FIG. 3 is a rear view thereof.  
 FIG. 4 is a left view thereof.  
 FIG. 5 is a right view thereof.  
 FIG. 6 is a top view thereof.  
 FIG. 7 is a bottom view thereof; and,  
 FIG. 8 is a bottom perspective view thereof.  
 The broken away symbols in the drawings indicate that the appearance of any portion of the article between the break lines forms no part of the claimed design.

**1 Claim, 7 Drawing Sheets**

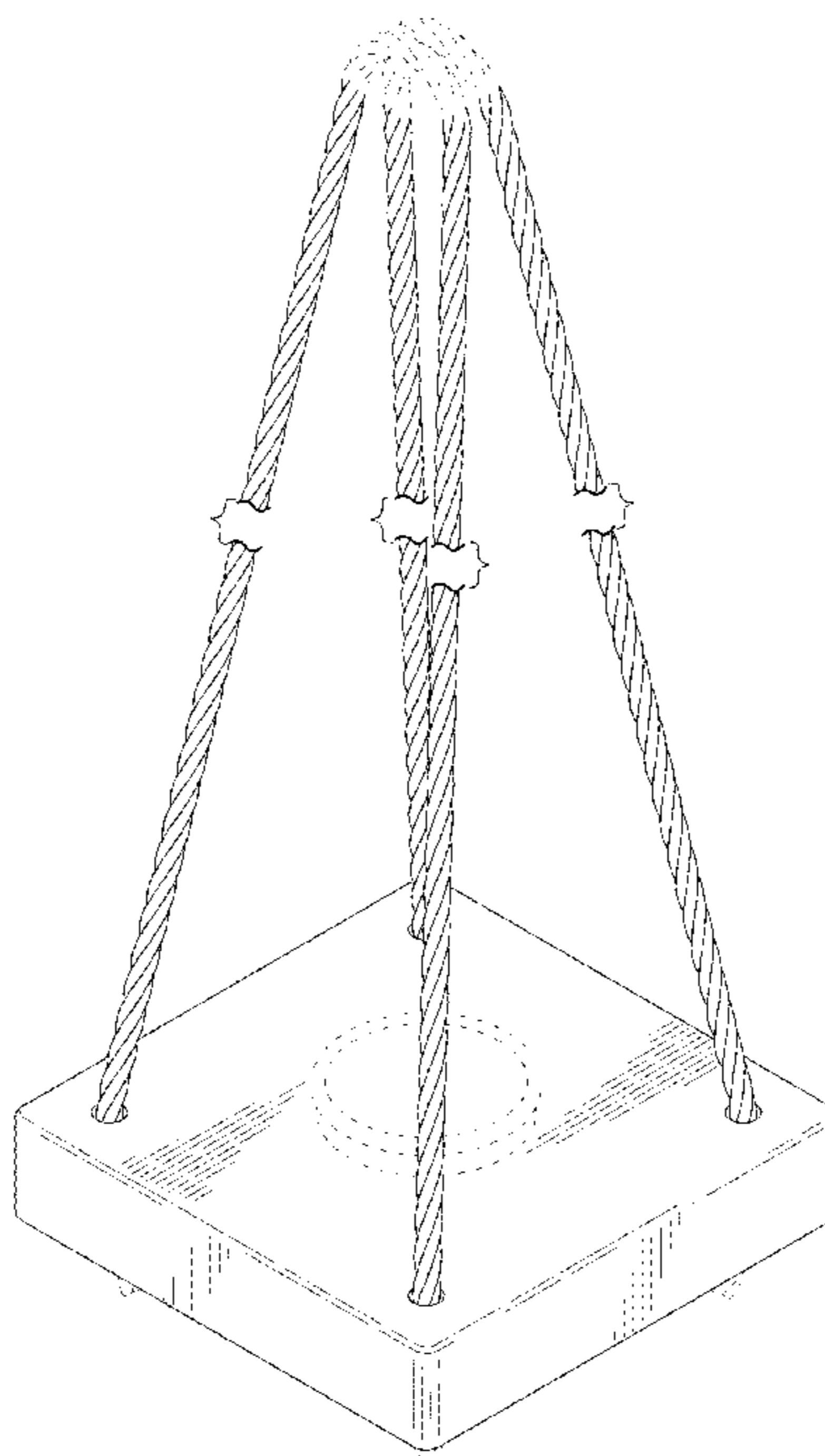

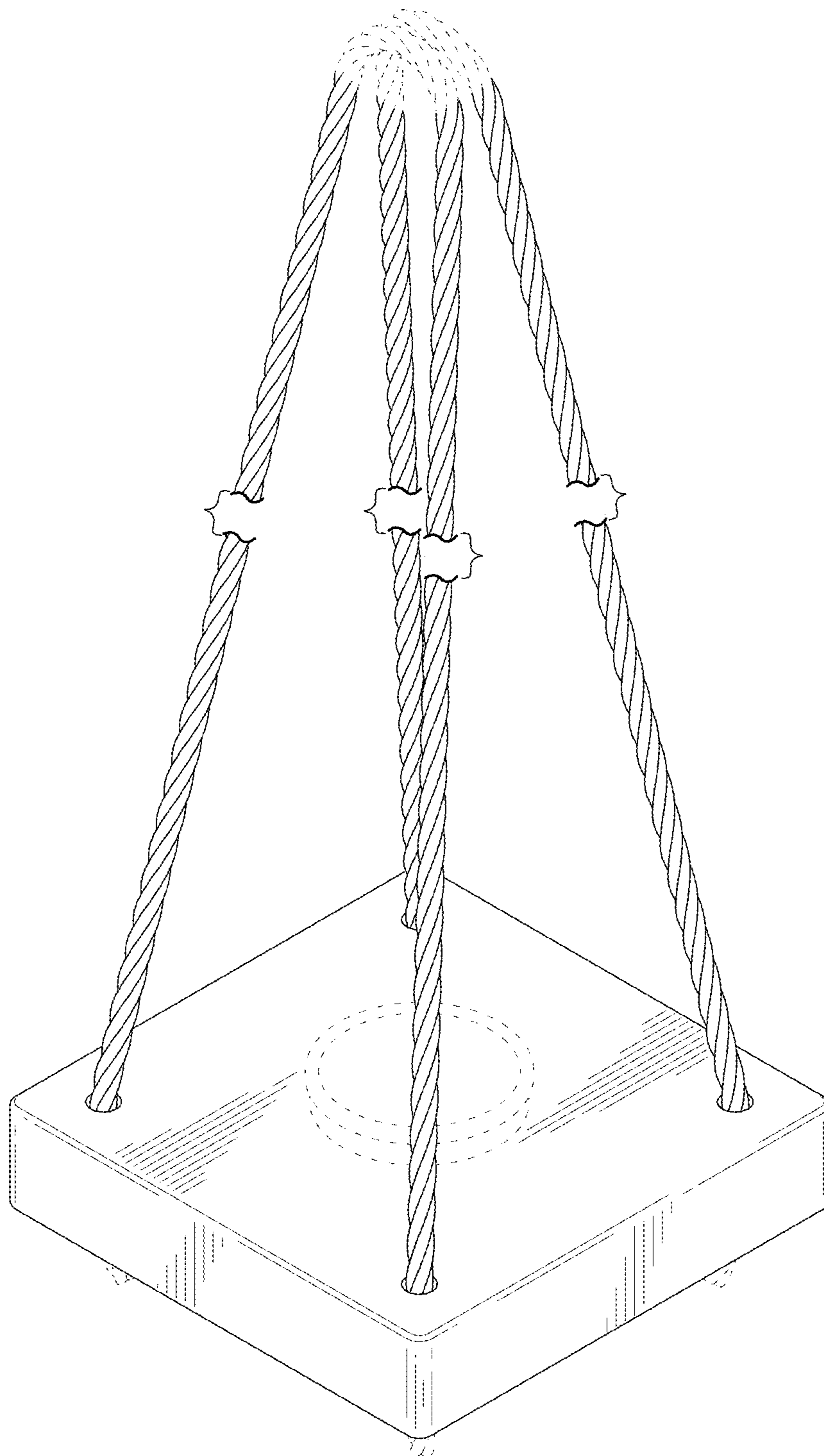

FIG. 1

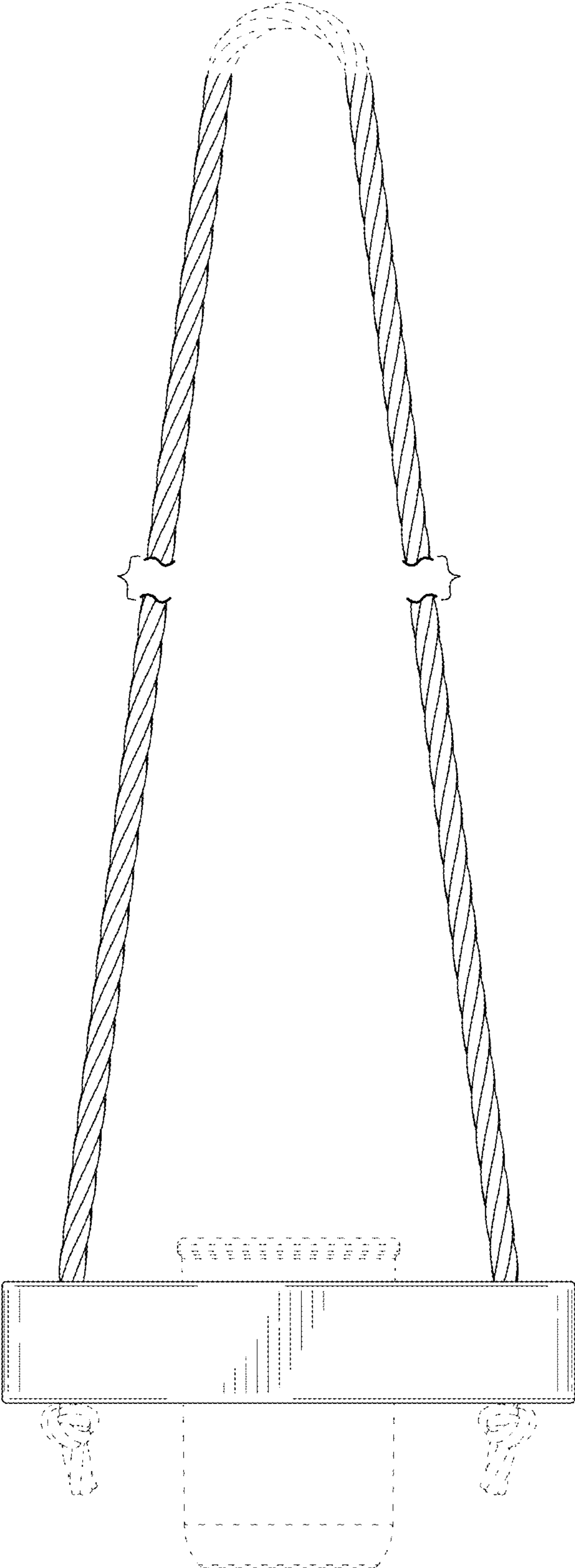

FIG. 2

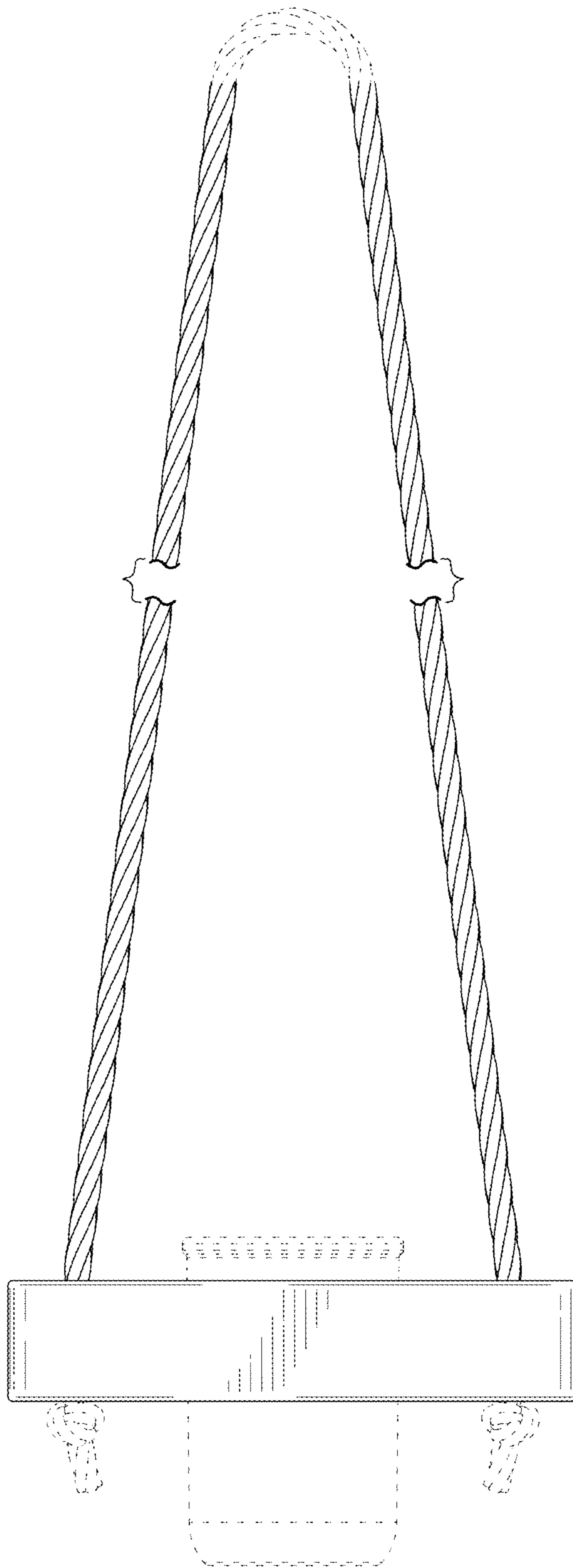

FIG. 3

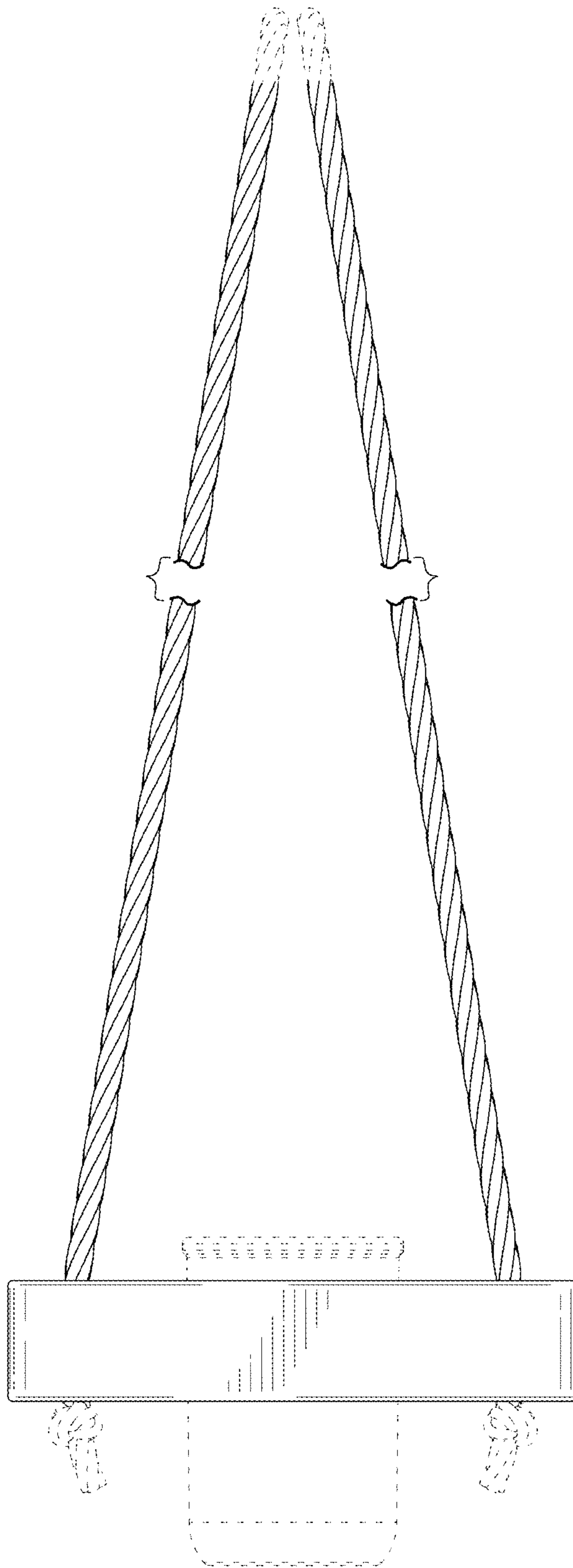

FIG. 4

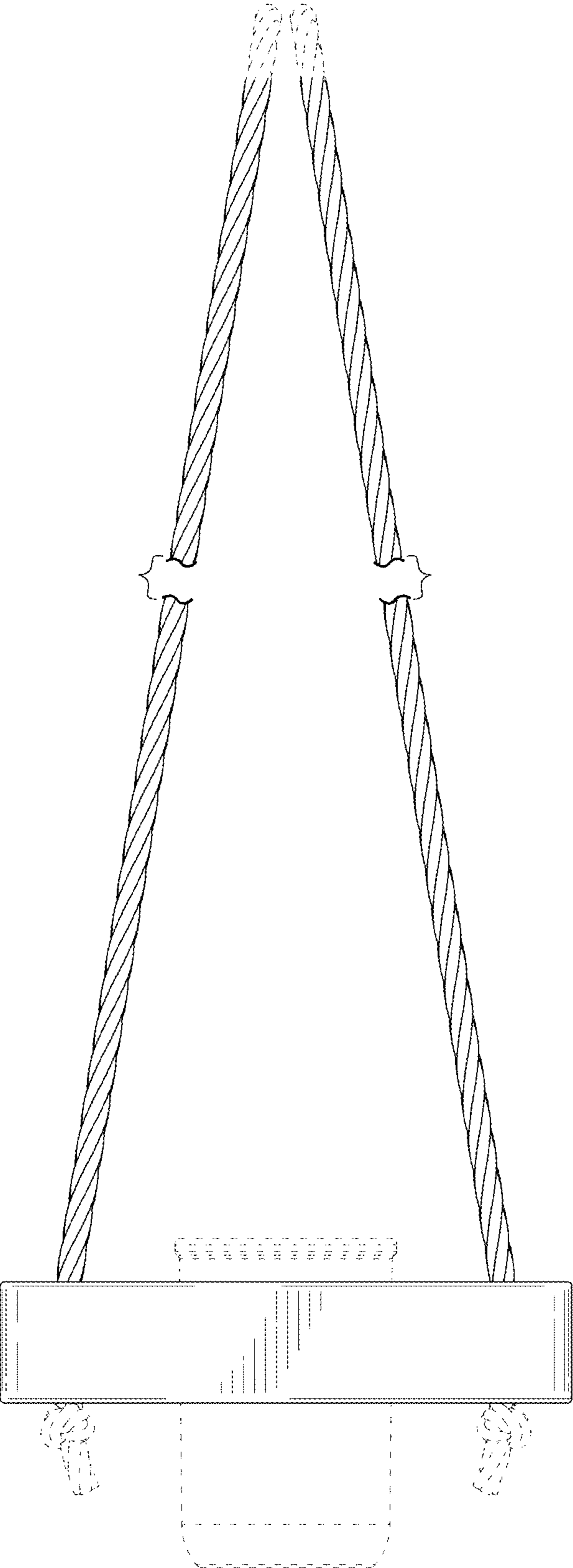

FIG. 5



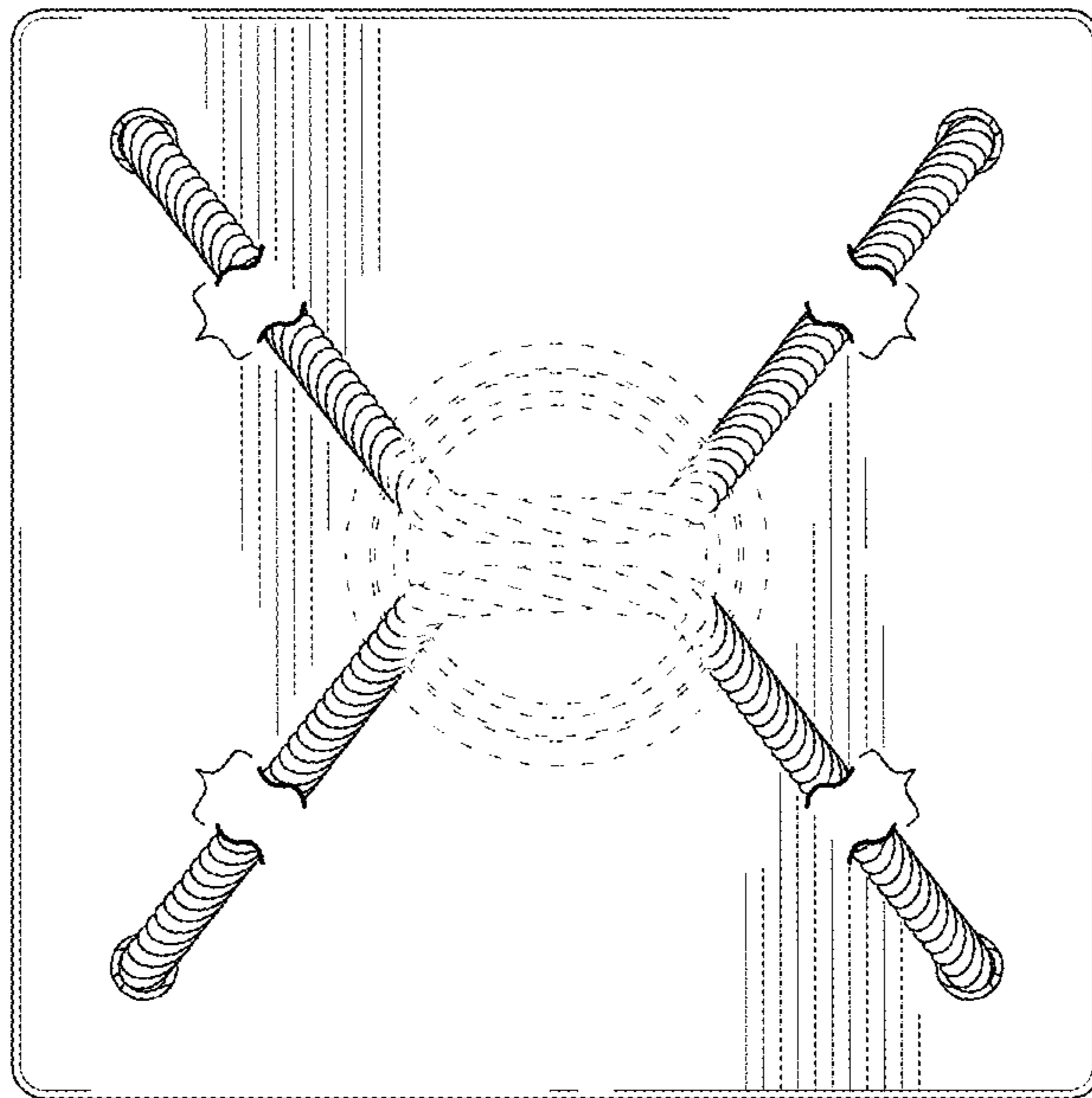

FIG. 6

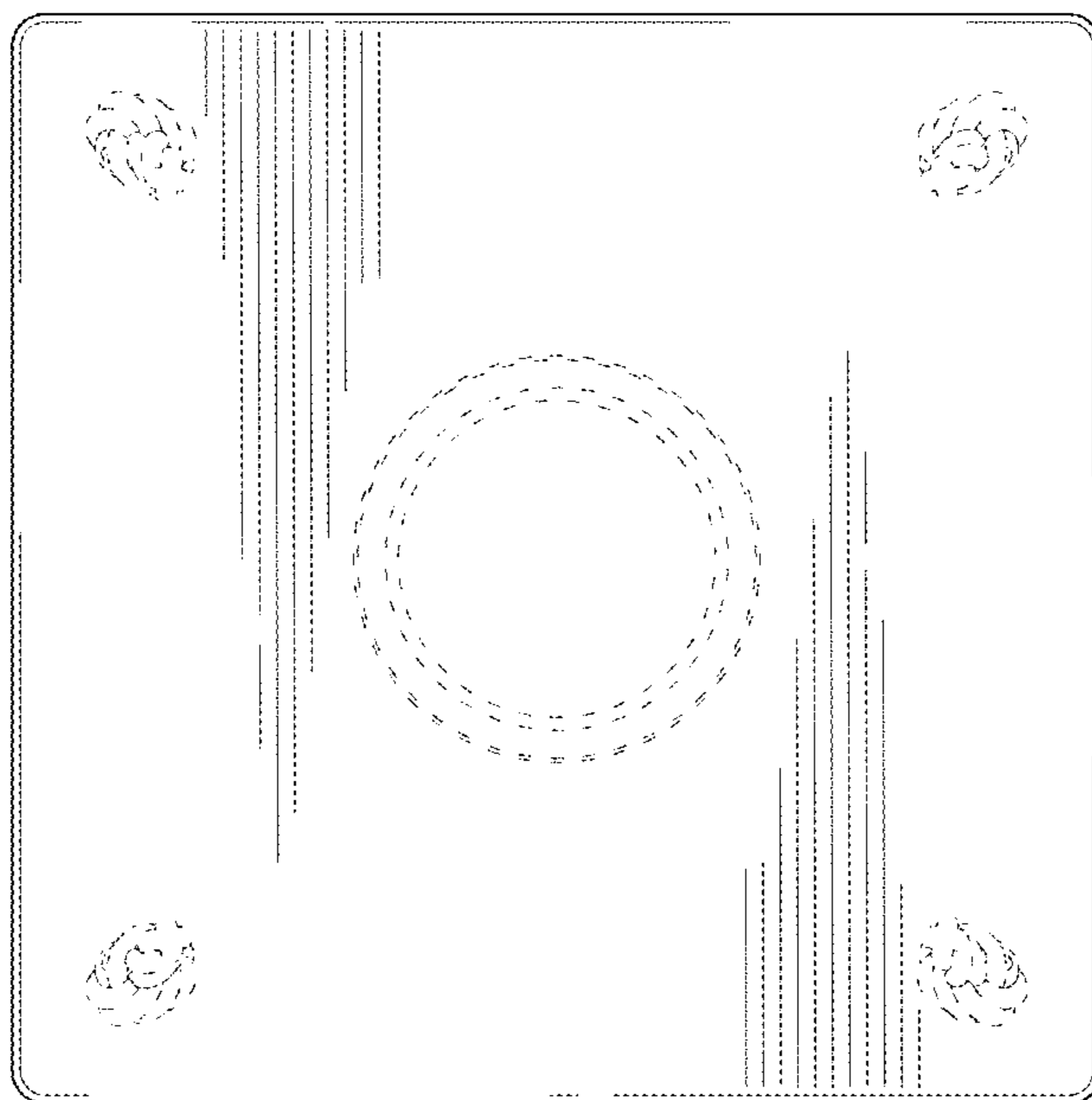

FIG. 7

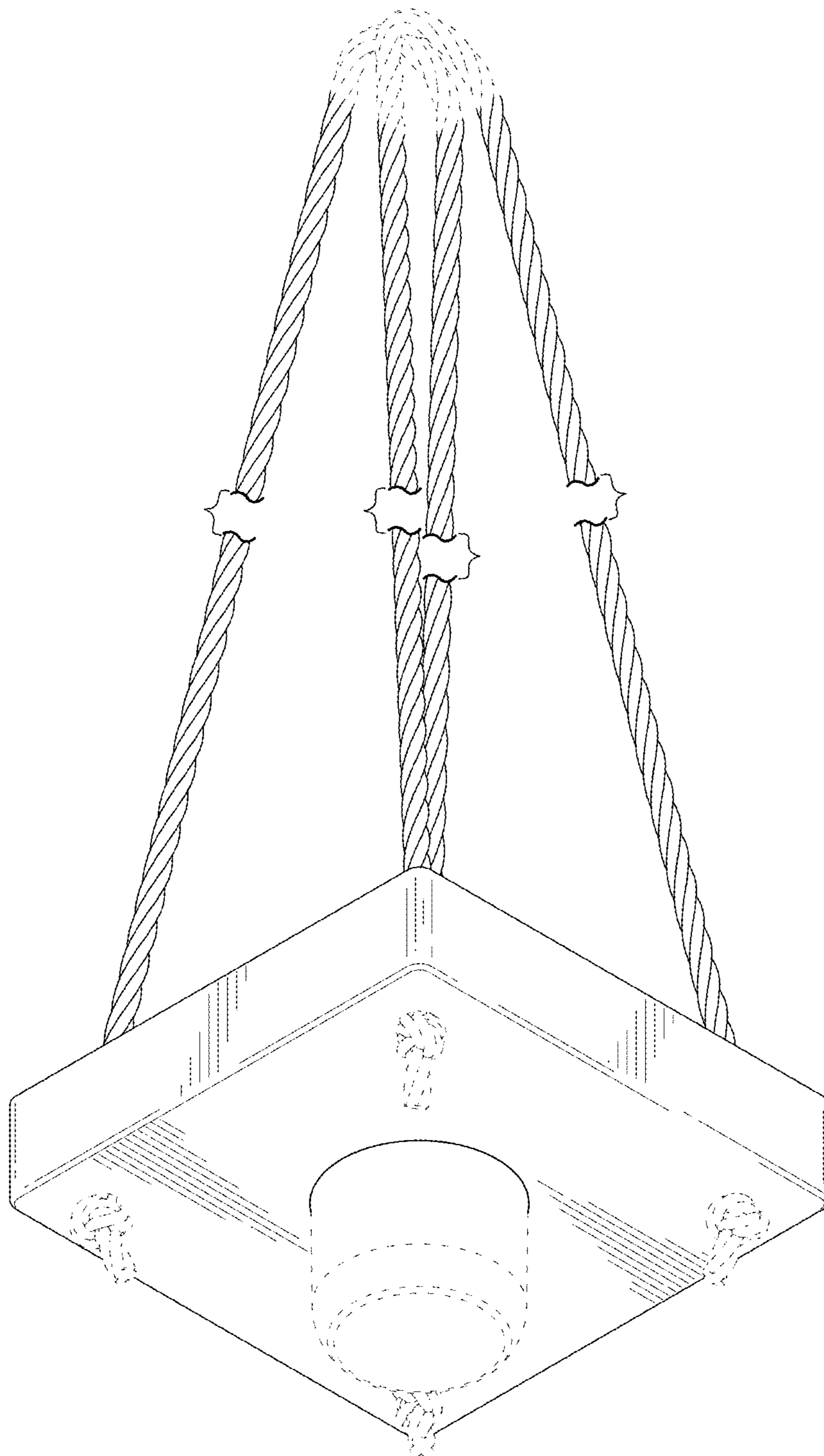

FIG. 8