



US00D955904S

(12) **United States Design Patent**
Pan et al.

(10) **Patent No.:** **US D955,904 S**
(45) **Date of Patent:** **** Jun. 28, 2022**

(54) **LIGHT DETECTION AND RANGING (LIDAR) COMPONENT**

(71) Applicant: **Beijing Voyager Technology Co., Ltd.**, Beijing (CN)

(72) Inventors: **Anan Pan**, Fremont, CA (US); **Henghui Jiang**, Newark, CA (US); **Ming-hui Wu**, Mountain View, CA (US); **Youmin Wang**, Berkeley, CA (US)

(73) Assignee: **BEIJING VOYAGER TECHNOLOGY CO., LTD.**, Beijing (CN)

(**) Term: **15 Years**

(21) Appl. No.: **29/764,334**

(22) Filed: **Dec. 29, 2020**

Related U.S. Application Data

(63) Continuation-in-part of application No. 17/134,286, filed on Dec. 26, 2020, which is a continuation-in-part of application No. 17/115,787, filed on Dec. 8, 2020.

(51) **LOC (13) Cl.** **10-04**

(52) **U.S. Cl.**
USPC **D10/74**

(58) **Field of Classification Search**
USPC D10/46, 65, 70, 74, 75, 81, 103;
D13/162, 173, 182; D16/203
CPC G01S 17/88; G01S 17/931; G01S 13/931;
G01S 15/931; G01S 2013/9325; G01S
13/93; G01S 13/426; G01S 15/93; G01S
7/4806; G08G 5/045; G08G 5/025; B60R
21/0134; B60R 2011/004; B60R
2300/301; B60Q 9/008; B60Q 1/0023
See application file for complete search history.

(56) **References Cited**

U.S. PATENT DOCUMENTS

D368,068	S	*	3/1996	Alden	D13/162
D609,195	S	*	2/2010	Yamashita	D13/162
D734,190	S	*	7/2015	Abdul-Hadi	D10/103
D742,338	S	*	11/2015	Akana	D13/182
D803,281	S	*	11/2017	Suzuki	D13/162
RE46,672	E	*	1/2018	Hall	G01S 7/4811
D816,048	S	*	4/2018	Stray	D13/162
10,295,656	B1	*	5/2019	Li	G01S 7/4813
10,310,058	B1	*	6/2019	Campbell	G01S 7/4817
10,451,716	B2	*	10/2019	Hughes	G01S 7/4817
10,705,189	B2	*	7/2020	Qiu	G01S 7/4863
D909,216	S	*	2/2021	Vuletici	D10/70
11,125,864	B2	*	9/2021	Qiu	G01S 7/4972

(Continued)

Primary Examiner — George D. Kirschbaum

Assistant Examiner — Lillian Windham

(74) *Attorney, Agent, or Firm* — Bayes PLLC

(57) **CLAIM**

The ornamental design for a light detection and ranging (LIDAR) component, as shown and described.

DESCRIPTION

FIG. 1 is a top front perspective view of a LIDAR component;
FIG. 2 is a top rear perspective view thereof;
FIG. 3 is a bottom rear perspective view thereof;
FIG. 4 is a right side view thereof;
FIG. 5 is a left side view thereof;
FIG. 6 is a front view thereof;
FIG. 7 is a rear view thereof;
FIG. 8 is a top view thereof; and,
FIG. 9 is a bottom view thereof.

The broken lines in the figures show portions of the LIDAR component that form no part of the claimed design.

1 Claim, 9 Drawing Sheets

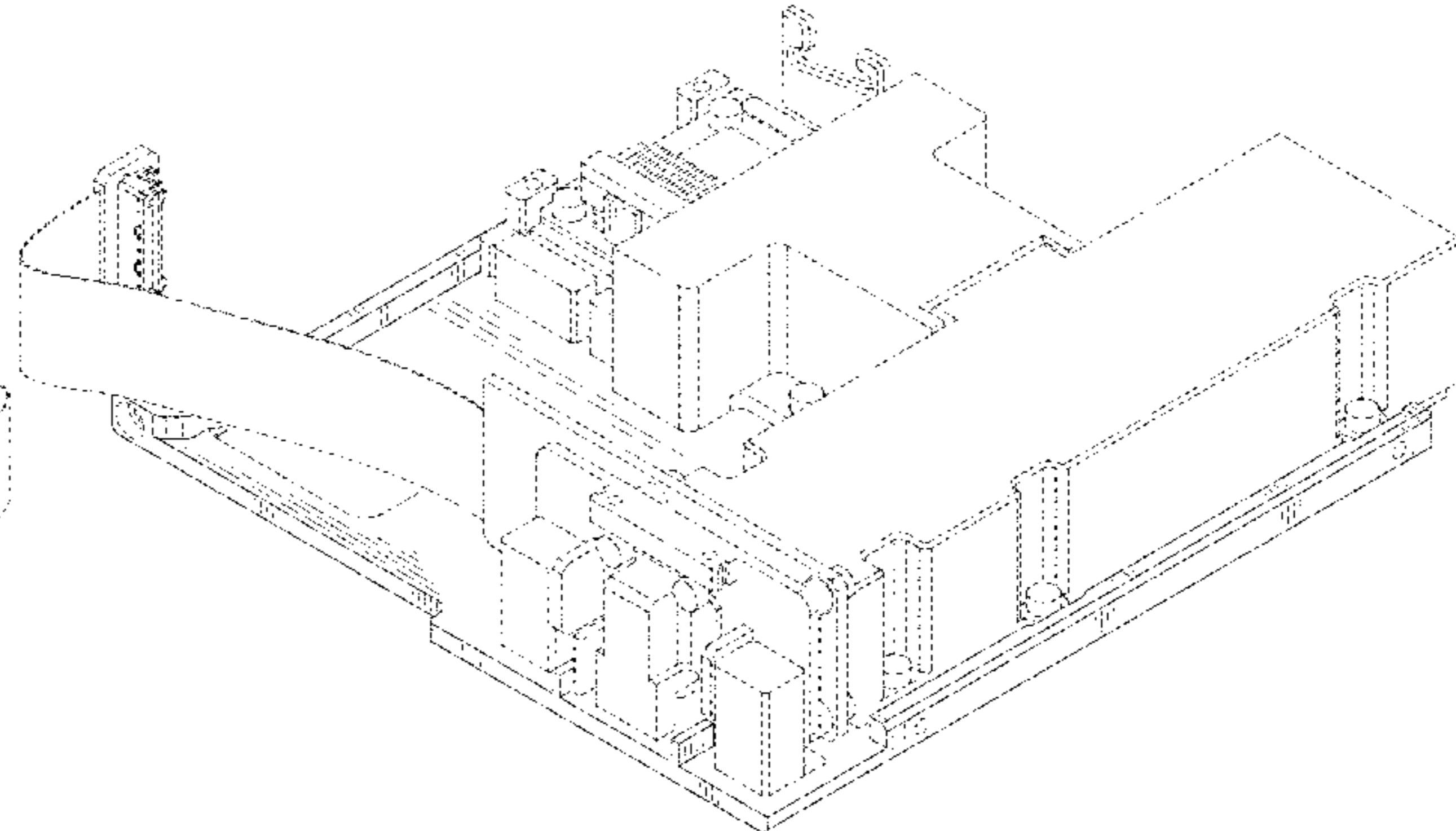
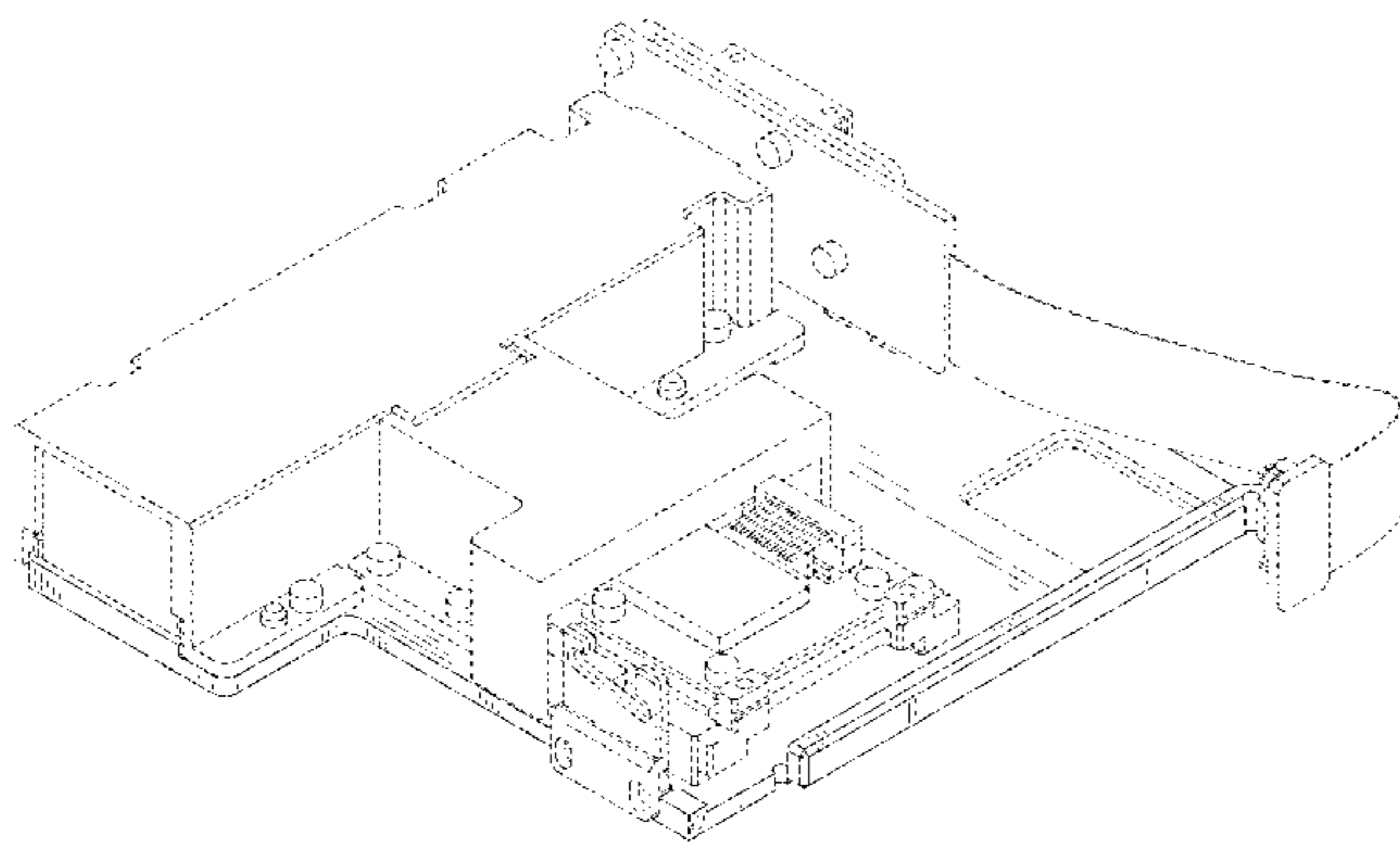

(56)

References Cited

U.S. PATENT DOCUMENTS

11,187,791 B2 * 11/2021 Ye G01S 7/4813
2011/0216304 A1 * 9/2011 Hall G01S 7/4813
356/4.01
2020/0355800 A1 * 11/2020 Toyama G01S 17/42
2021/0190918 A1 * 6/2021 Li G01S 7/4817
2022/0013957 A1 * 1/2022 Pan H05K 1/18

* cited by examiner

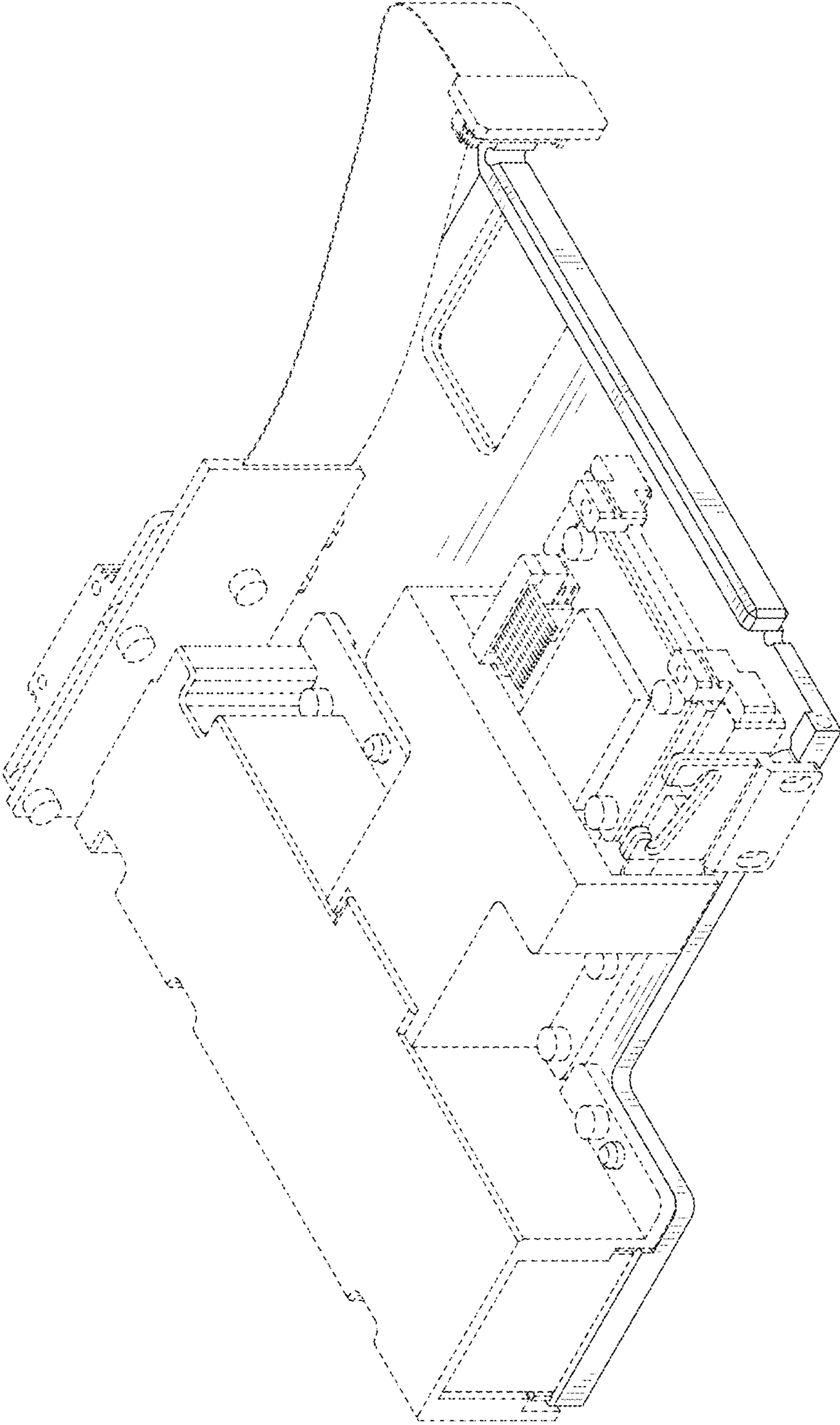

FIG. 1

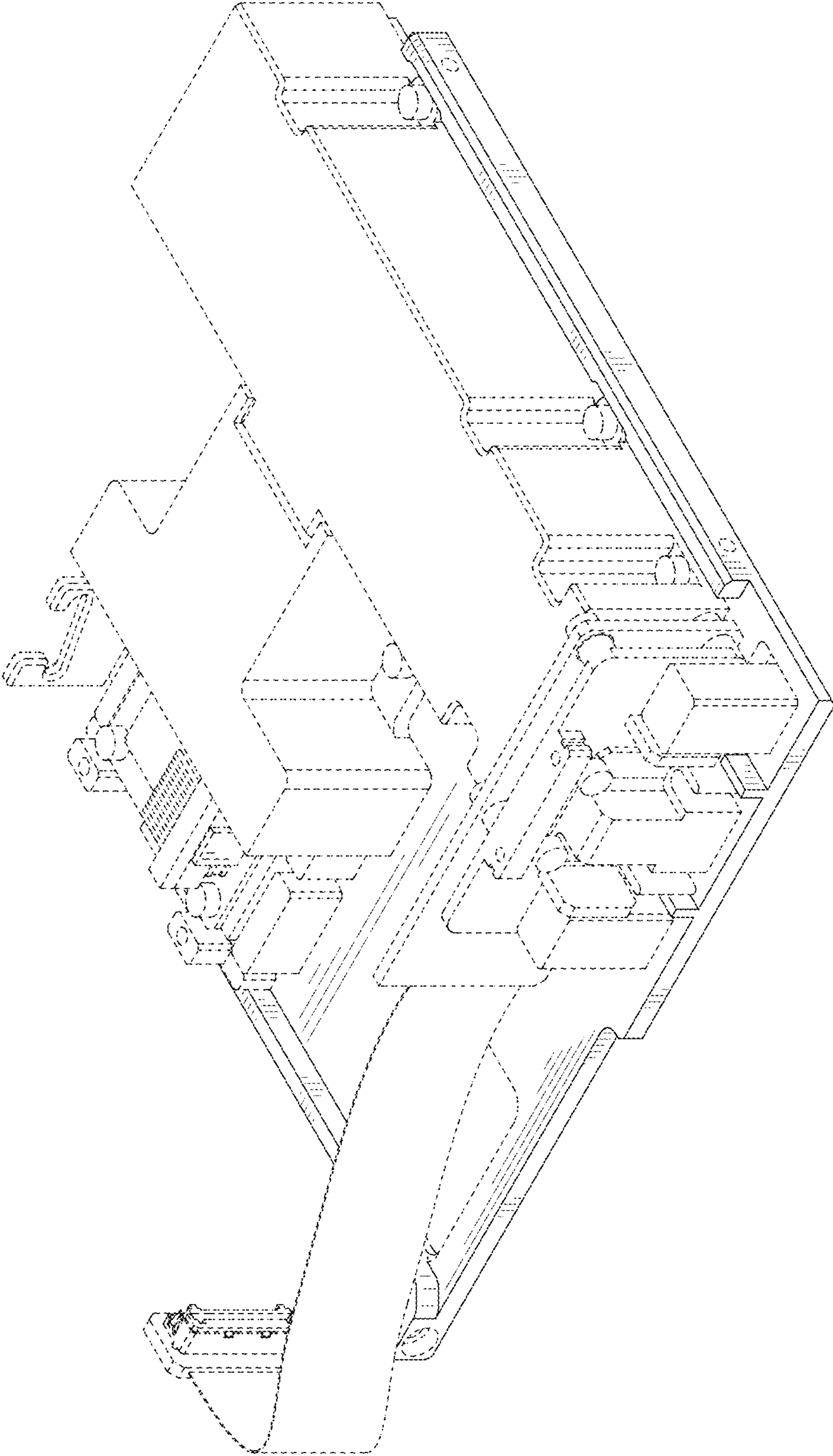

FIG. 2

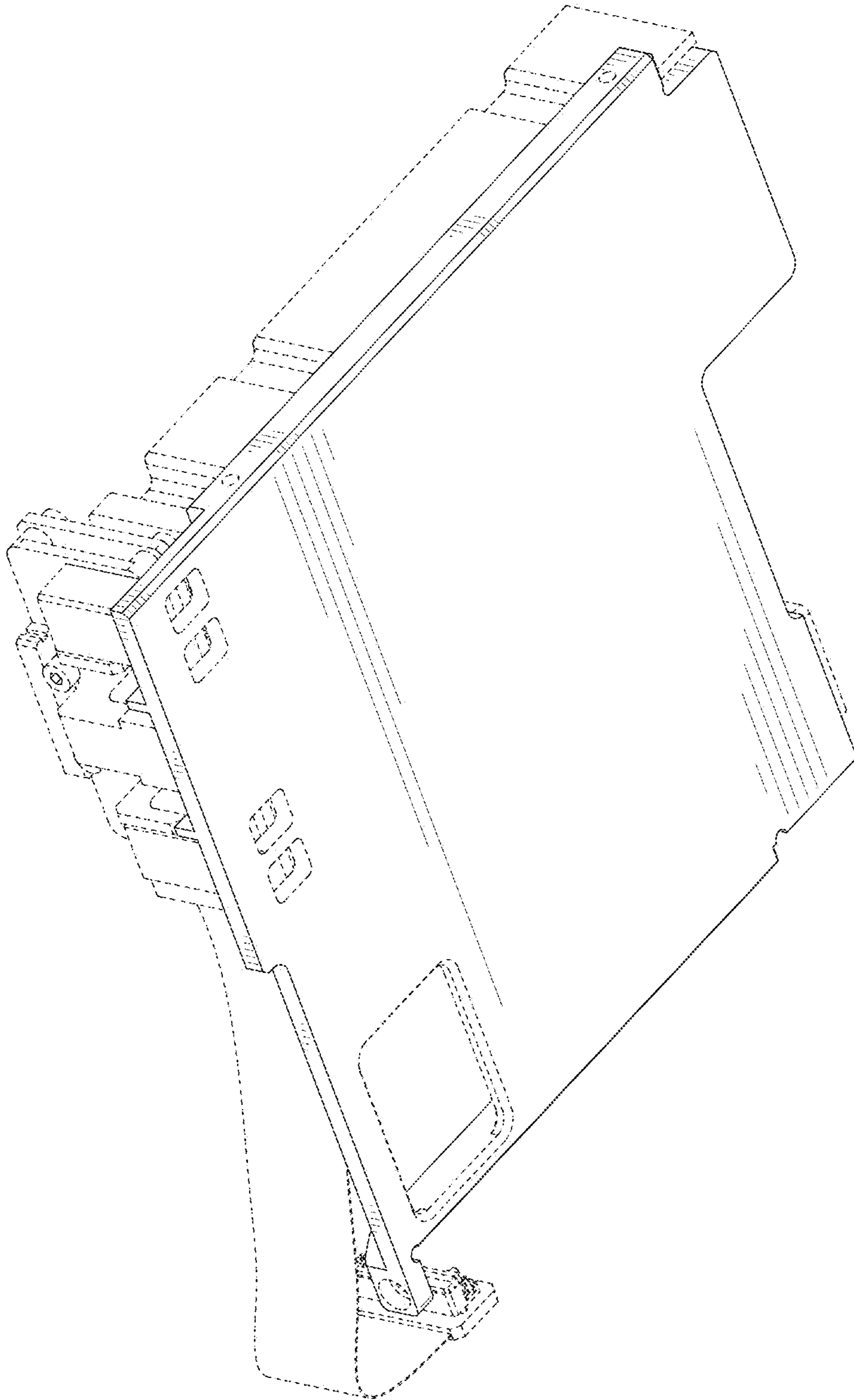

FIG. 3

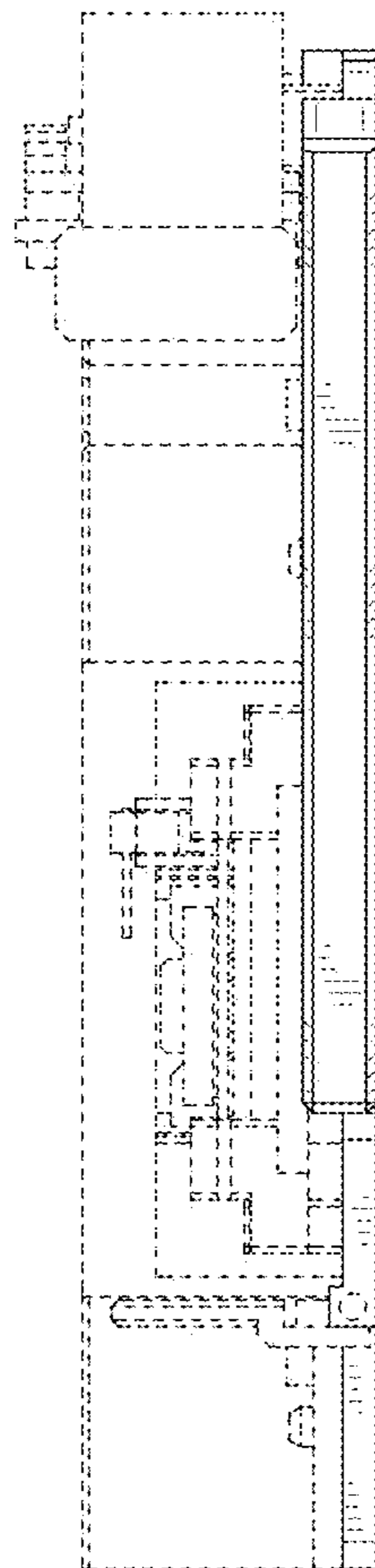

FIG. 4

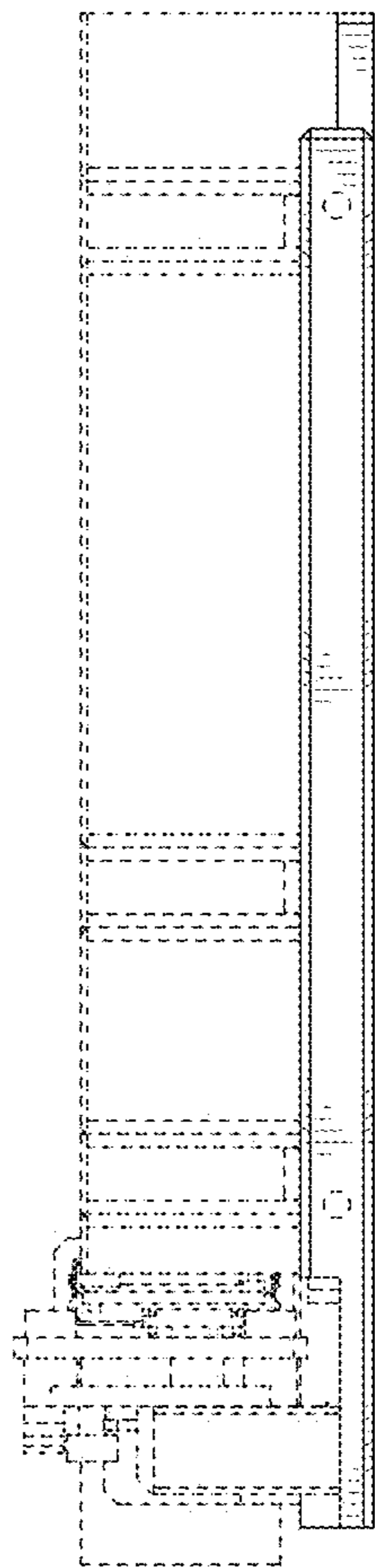

FIG. 5

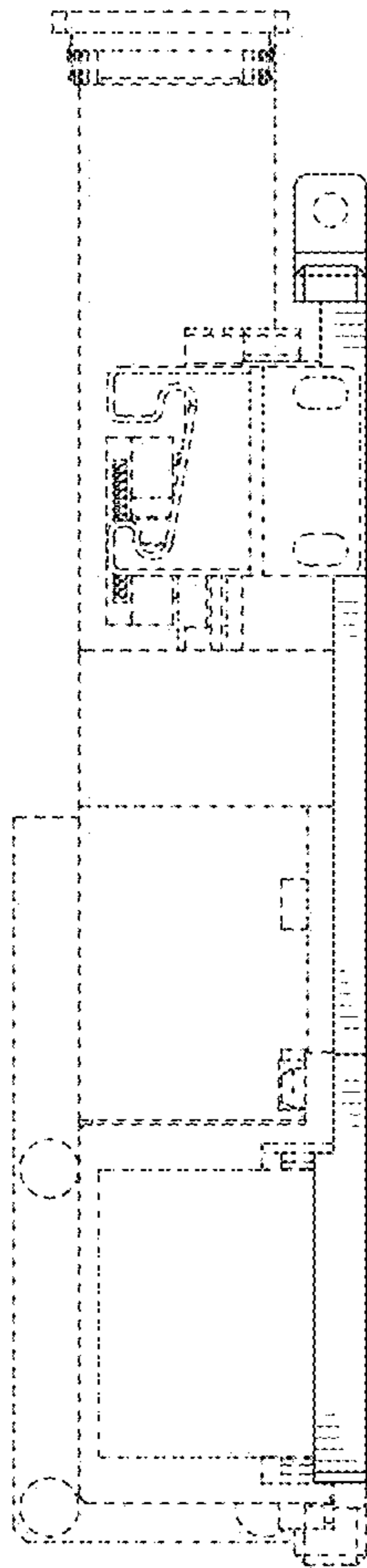

FIG. 6

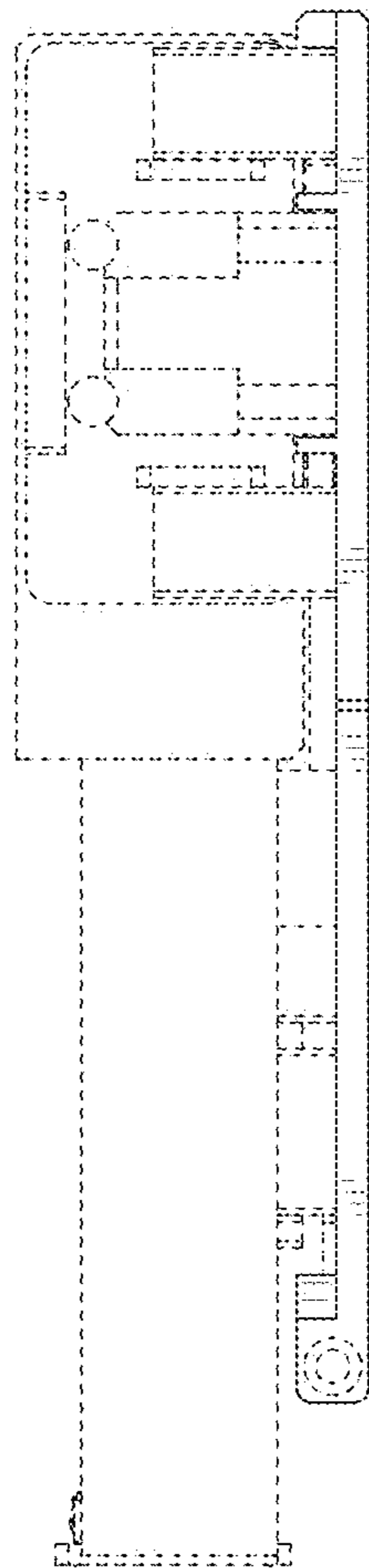

FIG. 7

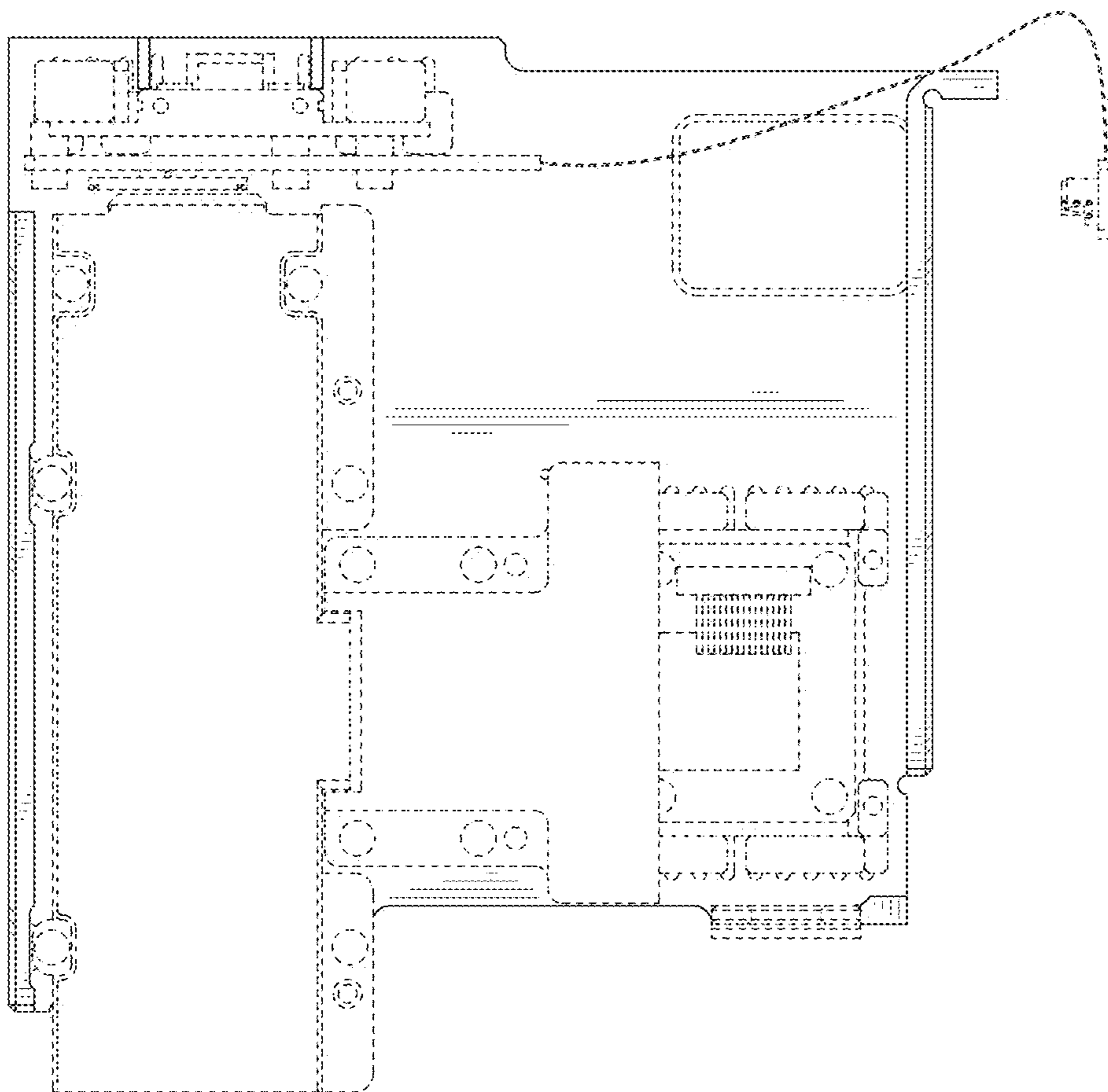

FIG. 8

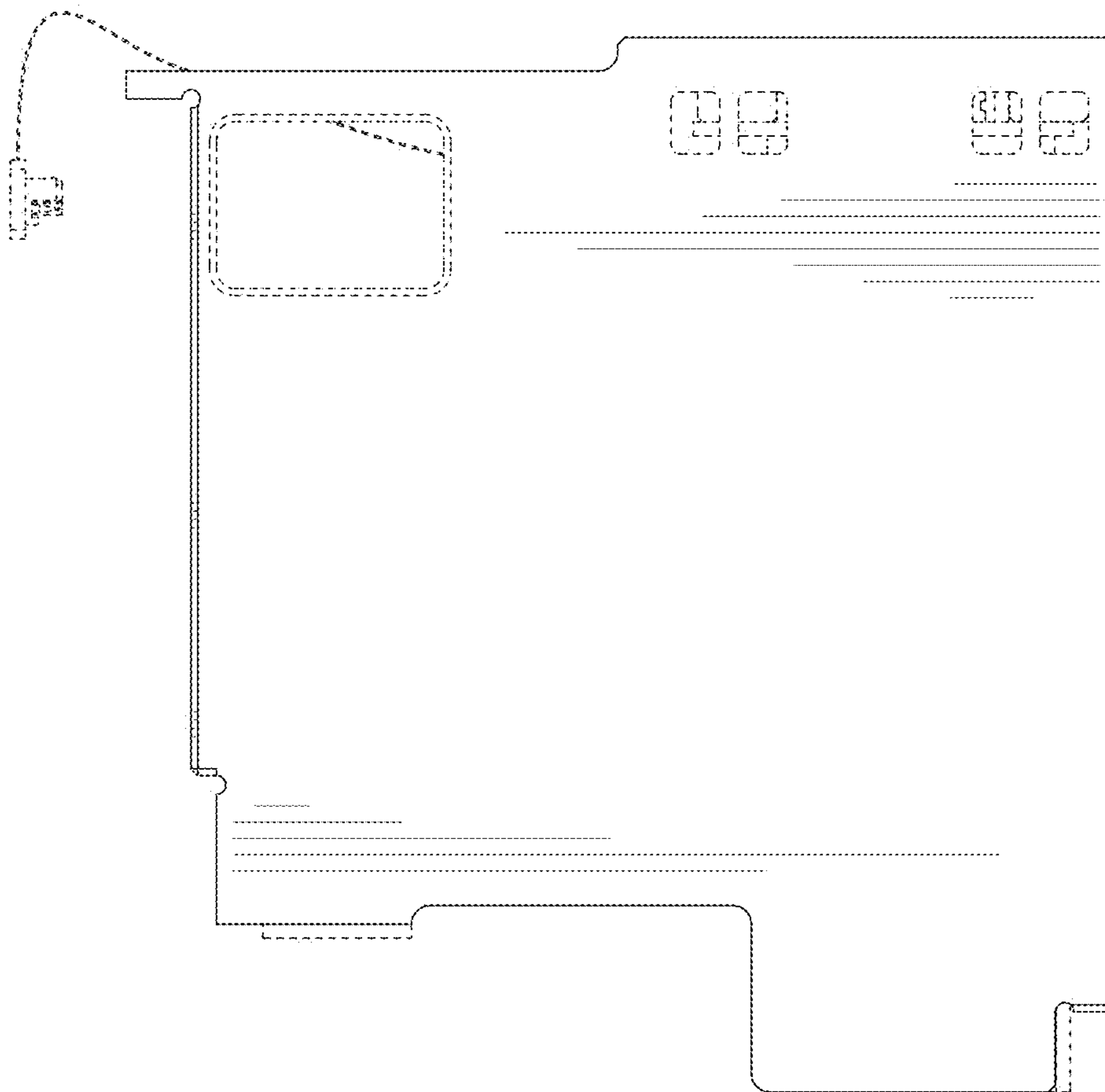

FIG. 9