



US00D955884S

(12) **United States Design Patent**  
**Clarke et al.**

(10) **Patent No.:** **US D955,884 S**  
(45) **Date of Patent:** **\*\* Jun. 28, 2022**

(54) **BOTTLE**

(71) Applicant: **Conopco Inc.**, Englewood Cliffs, NJ  
(US)  
(72) Inventors: **Peter Brian Clarke**, Fairfield, CT  
(US); **Luis Ramiro Gutierrez Montenegro**, Fairfield, CT (US);  
**Ricardo Felix Perez**, Fairfield, CT  
(US); **Trond Erik Tollefsen**, Fairfield,  
CT (US)  
(73) Assignee: **Conopco Inc.**, Englewood Cliffs, NJ  
(US)

D221,621 S \* 8/1971 Vanderhyde ..... D9/557  
D222,712 S \* 12/1971 Barker ..... D9/542  
D223,083 S \* 3/1972 Plunner ..... D9/563  
D225,726 S \* 1/1973 Auisander ..... D9/542  
D227,223 S \* 6/1973 Kretz ..... D9/542  
D236,801 S \* 9/1975 Waring ..... D9/563  
D243,064 S \* 1/1977 Beeman ..... D9/542  
D248,832 S \* 8/1978 Weckman ..... D9/543  
D252,670 S \* 8/1979 Beeman ..... D9/542  
D310,631 S \* 9/1990 Davis ..... D9/563  
D310,964 S \* 10/1990 Weckman ..... D9/542  
D333,984 S \* 3/1993 Maginnis, Jr. .... D9/569  
D333,985 S \* 3/1993 Maginnis, Jr. .... D9/569  
D352,461 S \* 11/1994 Flanagan ..... D9/542

(Continued)

(\*\*) Term: **15 Years**  
(21) Appl. No.: **29/733,852**  
(22) Filed: **May 7, 2020**

(30) **Foreign Application Priority Data**

Nov. 14, 2019 (EM) ..... 007229398-0001

(51) **LOC (13) Cl.** ..... **09-01**

(52) **U.S. Cl.**  
USPC ..... **D9/542; D9/550; D9/563; D9/575**

(58) **Field of Classification Search**  
USPC ..... D9/521, 522, 529, 549, 551, 552, 554,  
D9/558, 559, 560, 561, 562, 566, 567,  
D9/570-575, 430, 433, 434, 454, 500,  
D9/501, 503, 504, 682, 686, 691, 693,  
D9/530, 542, 543, 550, 563; D3/903  
CPC ..... A45D 40/0068; A45D 2200/051; B65D  
2251/0015; B65D 50/041; B65D  
2501/0081; B65D 1/0223; B65D 23/102  
See application file for complete search history.

(56) **References Cited**

**U.S. PATENT DOCUMENTS**

D208,116 S \* 7/1967 Landor ..... D9/542  
D209,102 S \* 10/1967 Linn ..... D9/542

**FOREIGN PATENT DOCUMENTS**

RU 00100158 \* 10/2016

*Primary Examiner* — Brett Miller

*Assistant Examiner* — Rani J Abdallah

(74) *Attorney, Agent, or Firm* — N.V. Nederlandsch  
Octrooibureau

(57) **CLAIM**

The ornamental design for a bottle, as shown and described.

**DESCRIPTION**

FIG. 1 is a front perspective view from the top and right side of a bottle showing our new design; FIG. 2 is a an elevational view of the front side thereof, FIG. 3 is a an elevational view of the back side thereof, FIG. 4 is an elevational view of the left side thereof; FIG. 5 is an elevational view of the right side thereof; FIG. 6 is a top plan view thereof; and, FIG. 7 is a bottom plan view thereof. All broken lines are directed to environment and are for illustrative purposes only; the broken lines form no part of the claimed design.

**1 Claim, 5 Drawing Sheets**

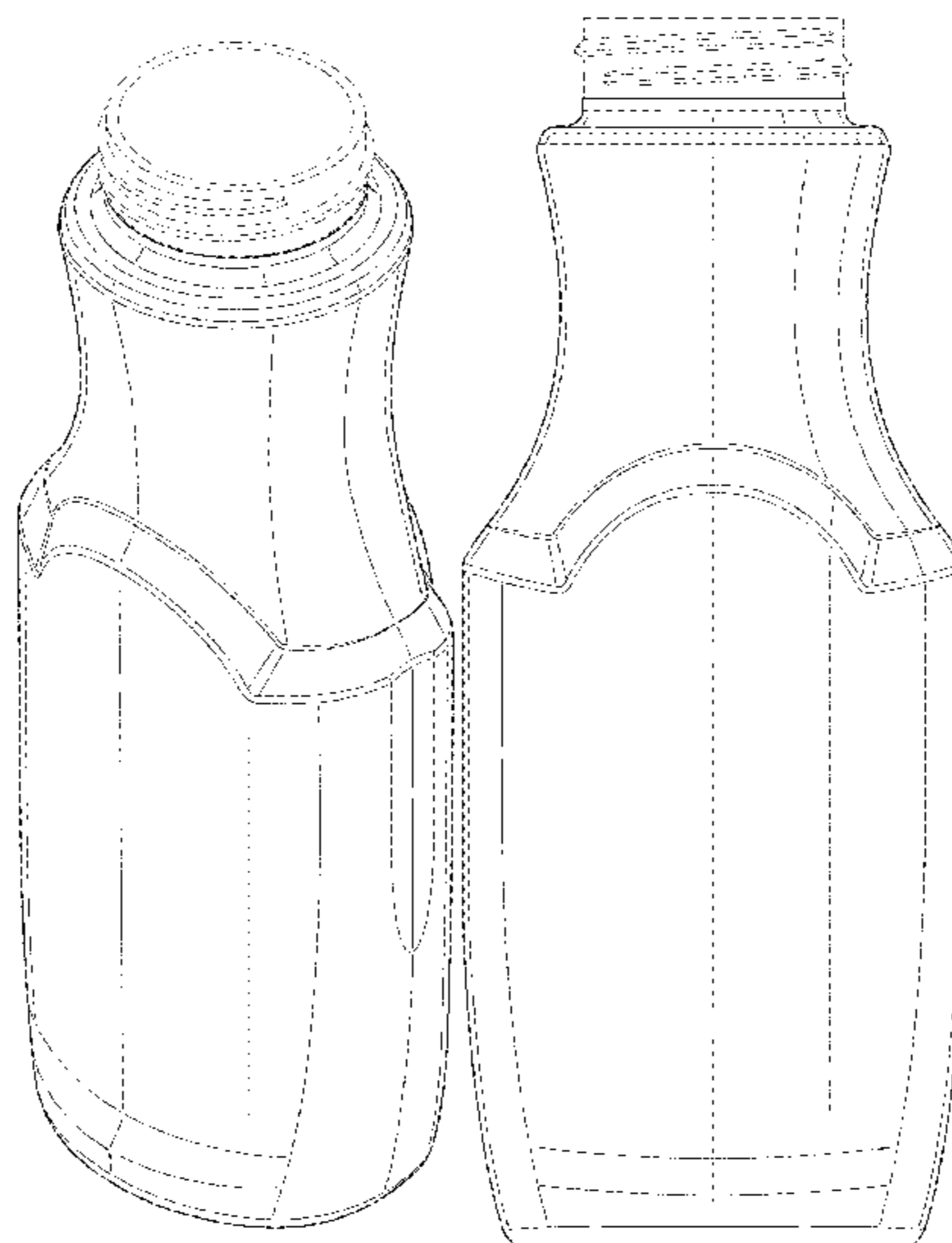

(56)

References Cited

U.S. PATENT DOCUMENTS

D369,979 S *	5/1996	Krampe .....	D9/542	D653,116 S *	1/2012	McMahon .....	D9/542
D416,791 S *	11/1999	Albrecht .....	D9/574	D653,555 S *	2/2012	Kelly .....	D9/563
D419,061 S *	1/2000	Croft .....	D9/542	D672,248 S *	12/2012	Nukuto .....	D9/542
D419,887 S *	2/2000	Dugan .....	D9/542	D690,601 S *	10/2013	Bryant .....	D9/542
D427,914 S *	7/2000	Croft .....	D9/542	D690,602 S *	10/2013	Bryant .....	D9/542
D446,127 S *	8/2001	Adee .....	D9/563	D693,689 S *	11/2013	Kim .....	D9/563
D446,730 S *	8/2001	Adee .....	D9/563	D697,415 S *	1/2014	Bryant .....	D9/542
D450,596 S *	11/2001	Adee .....	D9/563	D729,631 S *	5/2015	Kuzma .....	D9/542
D505,624 S *	5/2005	Helps .....	D9/563	D740,125 S *	10/2015	Kuzma .....	D9/542
D512,643 S *	12/2005	Busa, Jr. ....	D9/542	D740,677 S *	10/2015	Kuzma .....	D9/542
D526,569 S *	8/2006	Wurster .....	D9/563	D743,800 S *	11/2015	Whisler .....	D9/542
D536,619 S *	2/2007	Heisner .....	D9/541	D746,145 S *	12/2015	Kuzma .....	D9/542
D555,500 S *	11/2007	Johnston .....	D9/563	D747,653 S *	1/2016	Collier .....	D9/542
D569,733 S *	5/2008	Dodge .....	D9/570	D777,579 S *	1/2017	Jasso Gomez .....	D9/558
D584,634 S *	1/2009	Perez .....	D9/542	D820,096 S *	6/2018	Palm .....	D9/542
D585,746 S *	2/2009	Dodge .....	D9/571	D820,097 S *	6/2018	Palm .....	D9/542
D585,747 S *	2/2009	Dodge .....	D9/571	D899,255 S *	10/2020	Mendenhall, Jr. ....	D9/542
D585,755 S *	2/2009	Dodge .....	D9/563	D908,013 S *	1/2021	Rohling .....	D9/542
D609,576 S *	2/2010	Kuzma .....	D9/557	10,882,673 B2 *	1/2021	Shah .....	B65D 49/12
D616,756 S *	6/2010	Schlies .....	D9/542	D914,507 S *	3/2021	Koekkoek .....	D9/542
D626,002 S *	10/2010	Charyszyn .....	D9/542	D928,620 S *	8/2021	Clarke .....	D9/542
D641,247 S *	7/2011	Kuzma .....	D9/542	2008/0000932 A1 *	1/2008	Cleary .....	B65D 47/2031 222/215
D642,066 S *	7/2011	Kuzma .....	D9/563	2008/0061024 A1 *	3/2008	Keilen .....	B65D 79/0084 215/382
				2020/0165044 A1 *	5/2020	Shah .....	B65D 47/02

\* cited by examiner

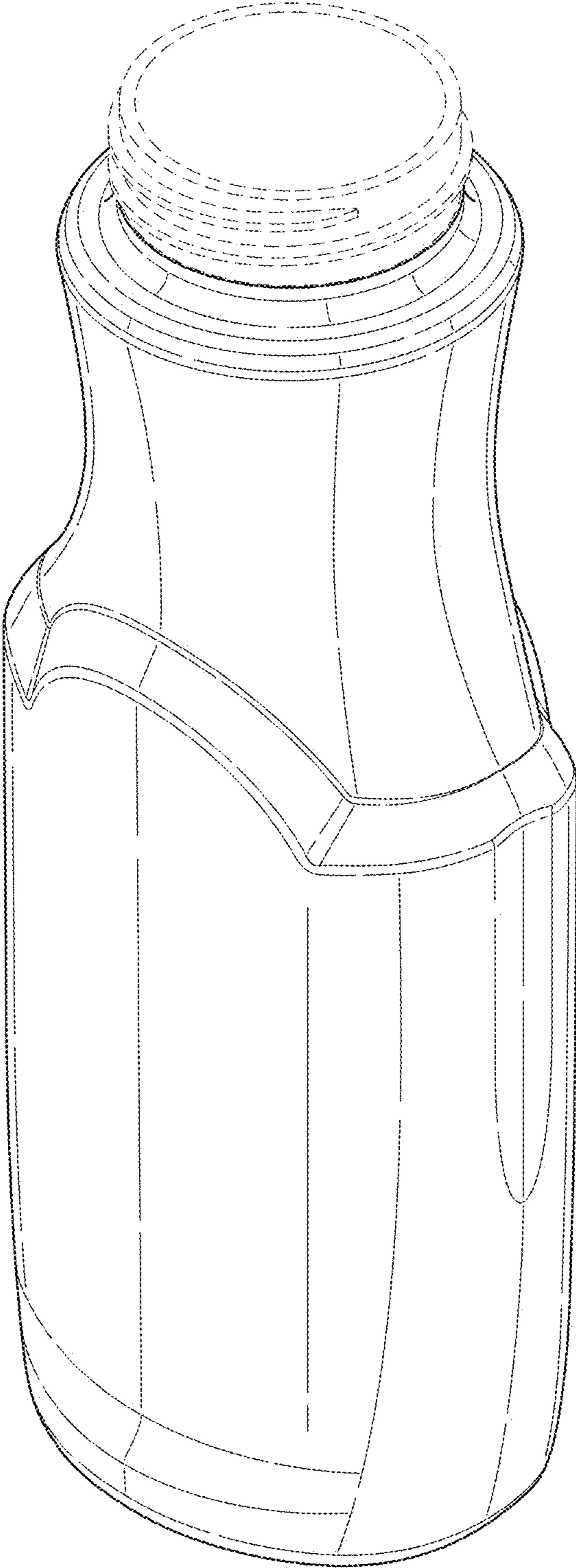

Fig. 1

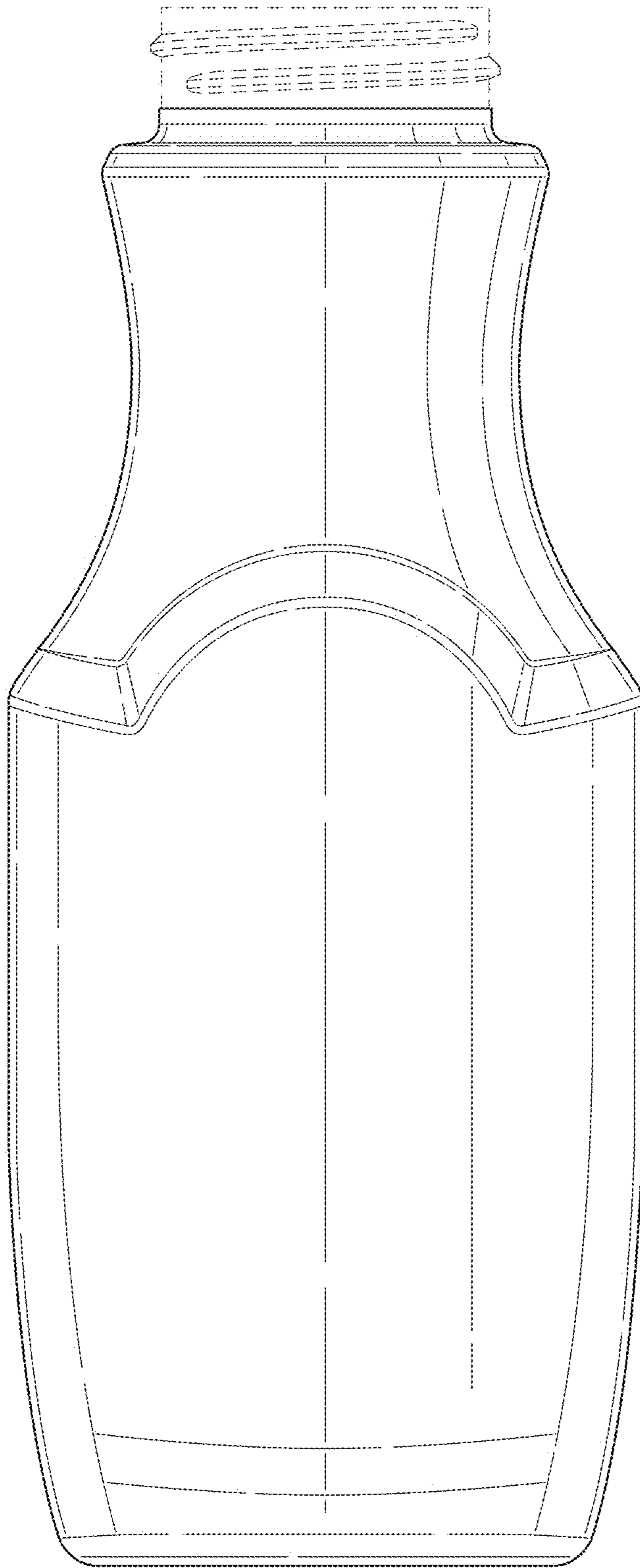

Fig. 2



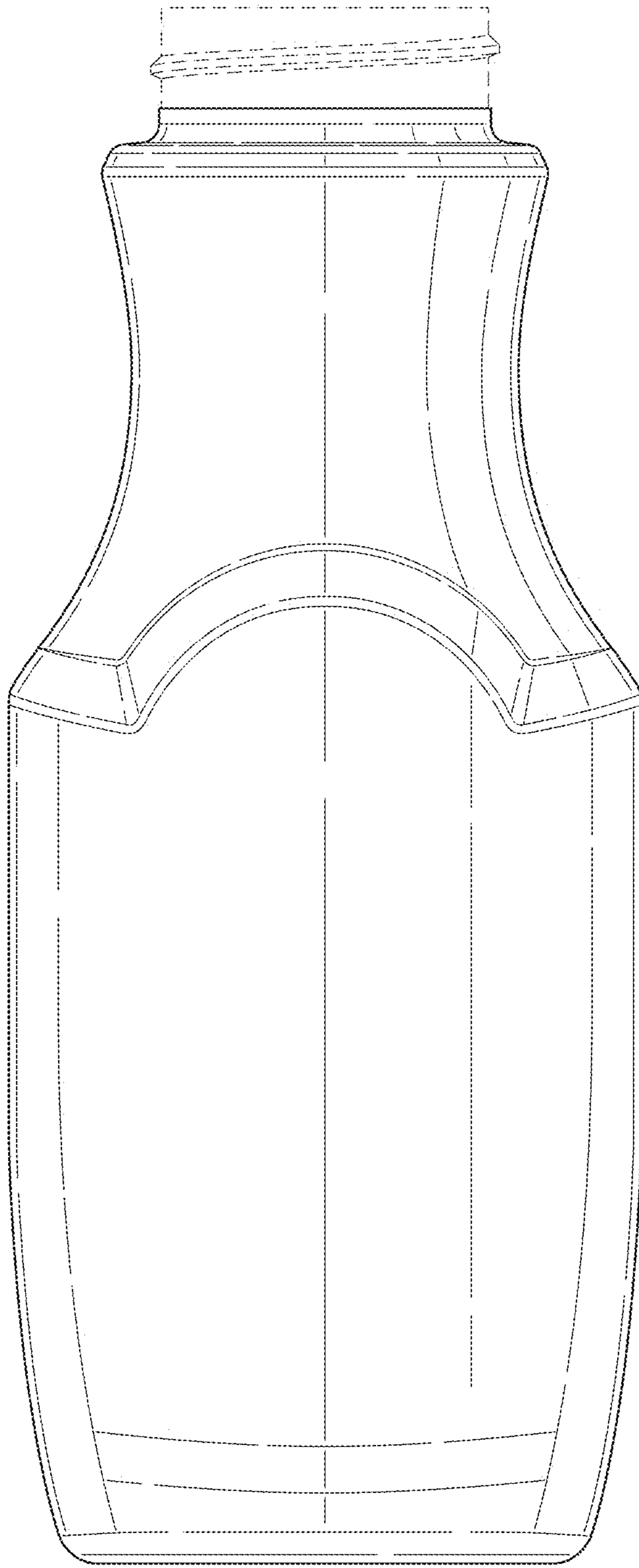

Fig. 3

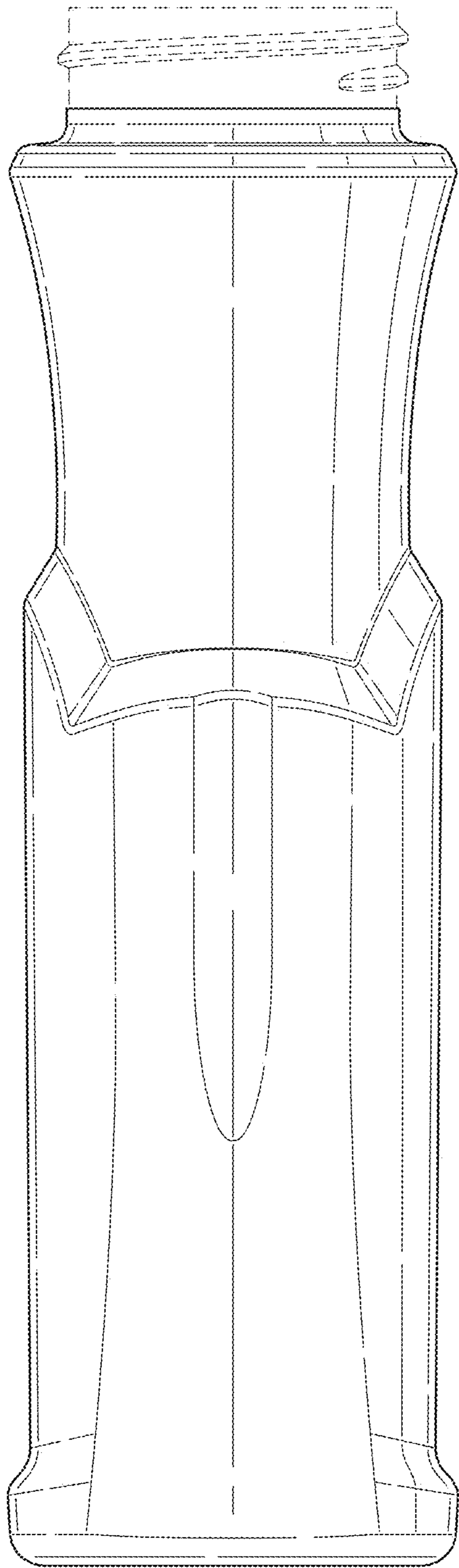

Fig. 4

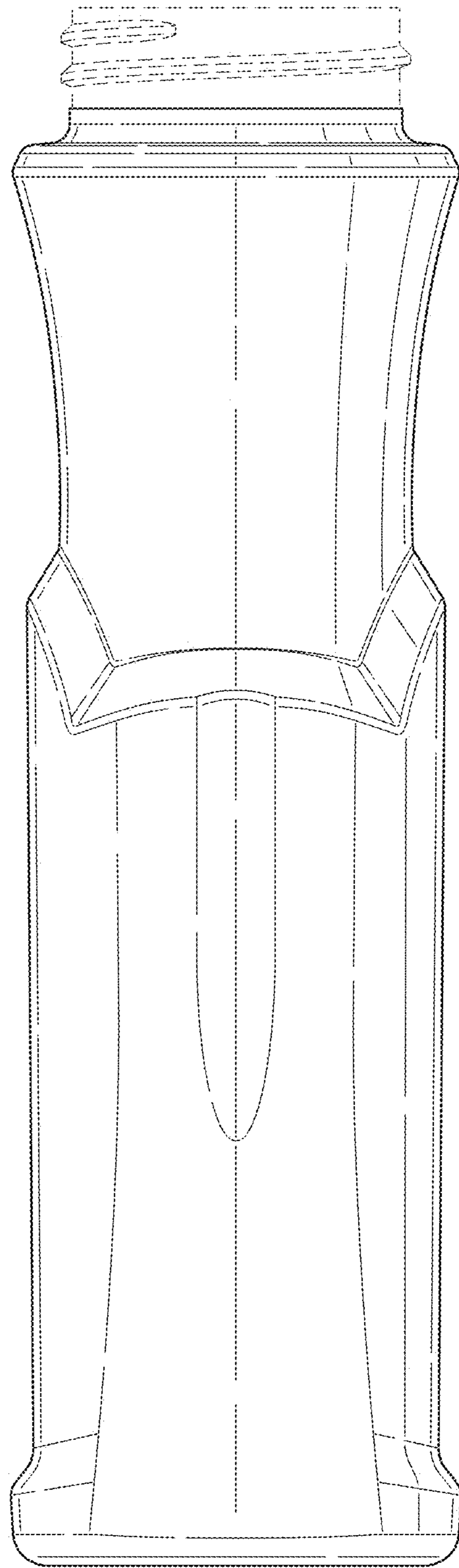

Fig. 5

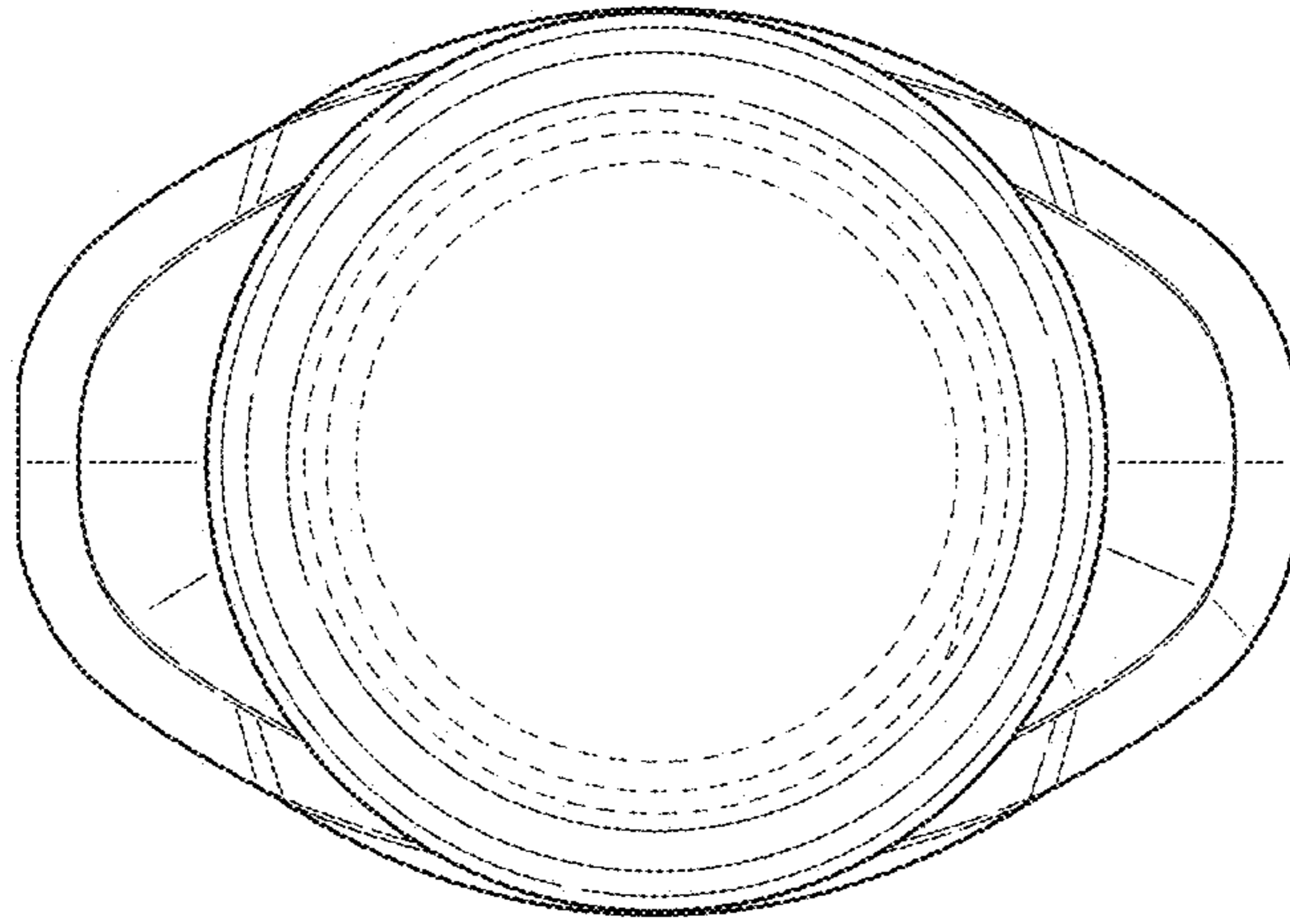

Fig. 6

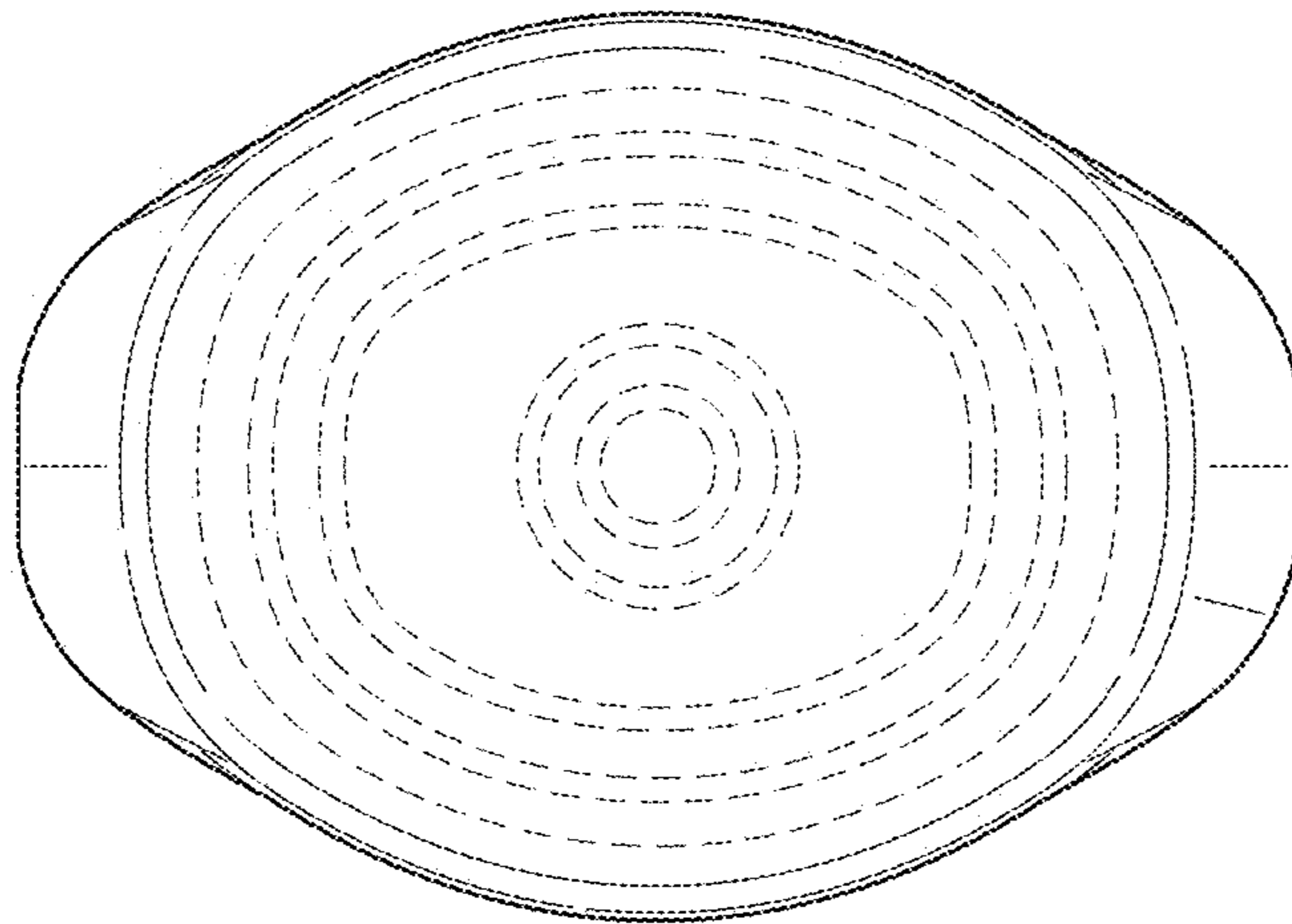

Fig. 7