



US00D955874S

(12) **United States Design Patent**
Marino et al.

(10) **Patent No.:** **US D955,874 S**
(45) **Date of Patent:** **** Jun. 28, 2022**

(54) **CONTAINER**

(71) Applicant: **S.C. Johnson & Son, Inc.**, Racine, WI (US)

(72) Inventors: **Samuel J. Marino**, Oak Creek, WI (US); **Kasey A. Fuller**, Freeland, MI (US); **Amy P. Goldsmith**, Saint Francis, WI (US); **Brian T. Davis**, Burlington, WI (US); **Donald E. McCumber**, Madison, WI (US); **Pierce J. Peterson**, Oregon, WI (US); **Michael T. Robl**, Madison, WI (US)

(73) Assignee: **S. C. Johnson & Son, Inc.**, Racine, WI (US)

(**) Term: **15 Years**

(21) Appl. No.: **29/718,140**

(22) Filed: **Dec. 20, 2019**

(51) **LOC (13) Cl.** **09-03**

(52) **U.S. Cl.**
USPC **D9/425**; D9/429

(58) **Field of Classification Search**
USPC D9/414-419, 432, 420, 425, 429, 431;
D7/354, 357, 553.1, 553.2, 555, 601, 602,
D7/610, 615, 620, 703, 707, 543, 545,
D7/603

CPC B65D 5/62; B65D 5/42; B65D 5/5206;
B65D 2543/00296; B65D 21/02

See application file for complete search history.

(56) **References Cited**

U.S. PATENT DOCUMENTS

3,447,714 A 6/1969 Elliot
D320,743 S * 10/1991 Alexander D9/425
D323,114 S * 1/1992 Sheehan D9/420
6,170,696 B1 1/2001 Tucker et al.
6,467,647 B1 10/2002 Tucker et al.

6,672,473 B2 1/2004 Tornainen et al.
6,910,599 B2 6/2005 Tucker et al.
D512,278 S 12/2005 Schultz et al.
D539,099 S 3/2007 Tucker et al.
D541,598 S 5/2007 Kim
D542,100 S 5/2007 Kim et al.

(Continued)

FOREIGN PATENT DOCUMENTS

EM 000202858-0002 7/2004
EM 001259295-0007 2/2011

(Continued)

OTHER PUBLICATIONS

Ziploc Food Storage Meal Prep Containers. Date first available 2016. Visited Sep. 24, 2021. <https://www.amazon.com/Ziploc-Containers-Variety-Pack-Count/dp/B01IH2TRI8> (Year: 2016).*

(Continued)

Primary Examiner — Darcey E Gottschalk

Assistant Examiner — Vanessa Michelle Pursley

(74) *Attorney, Agent, or Firm* — Sterne, Kessler, Goldstein & Fox P.L.L.C.

(57) **CLAIM**

The ornamental design for a container, as shown and described.

DESCRIPTION

FIG. 1 is a top front perspective view of a container showing the claimed design;

FIG. 2 is a bottom front perspective view thereof;

FIG. 3 is a front view thereof;

FIG. 4 is a left side view thereof;

FIG. 5 is a right side view thereof;

FIG. 6 is a rear view thereof;

FIG. 7 is a top view thereof; and,

FIG. 8 is a bottom view thereof.

1 Claim, 8 Drawing Sheets

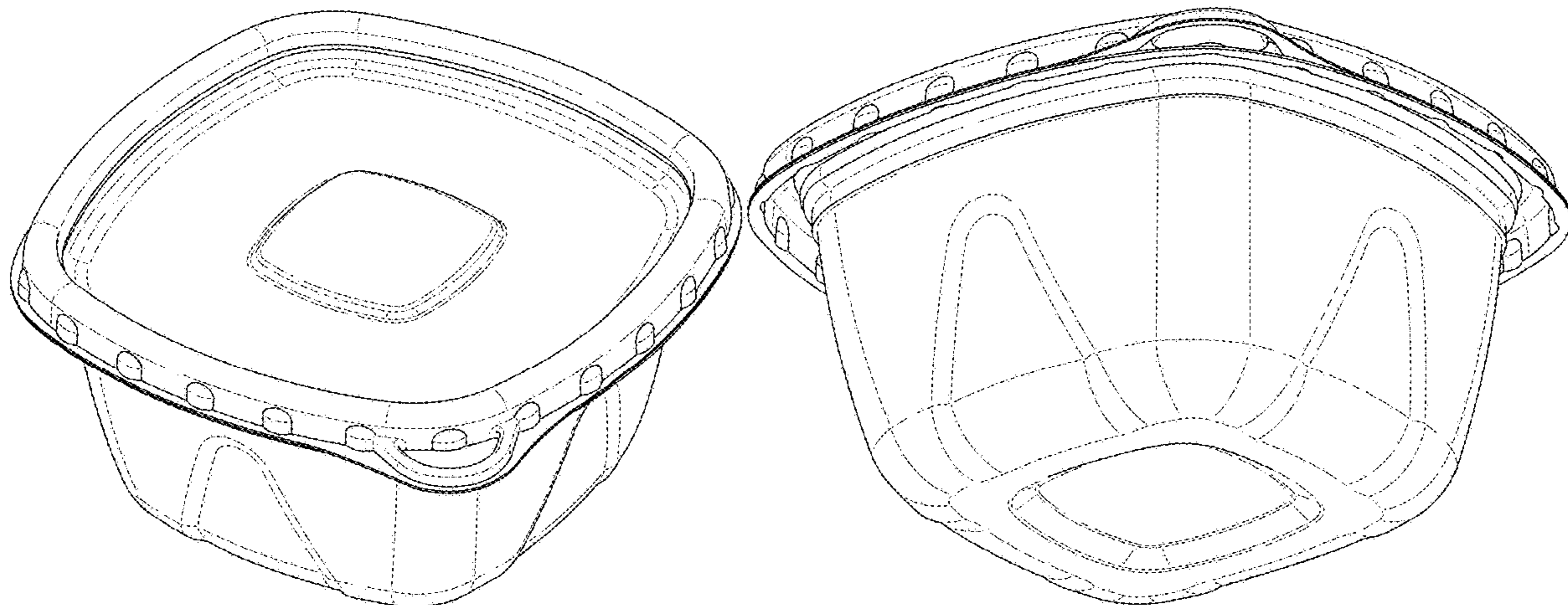

(56)

References Cited

U.S. PATENT DOCUMENTS

D547,115 S 7/2007 Bouveret et al.
 7,261,219 B2 8/2007 Tucker et al.
 D551,496 S 9/2007 Ablo et al.
 D551,515 S 9/2007 Ablo et al.
 D555,983 S 11/2007 Tucker et al.
 D557,569 S 12/2007 Stamper et al.
 D562,640 S 2/2008 Tucker et al.
 D566,482 S 4/2008 Tucker et al.
 D568,693 S 5/2008 Furlong
 D613,111 S 4/2010 Furlong
 D615,349 S 5/2010 Furlong
 D633,341 S 3/2011 Smyers
 D643,251 S 8/2011 Stamper et al.
 D649,410 S 11/2011 Segal
 D649,838 S 12/2011 Stamper et al.
 D666,875 S 9/2012 Rusnak
 D666,876 S 9/2012 Rusnak
 8,267,278 B2 9/2012 Tucker et al.
 D672,612 S 12/2012 Stamper et al.
 D679,587 S * 4/2013 Krueger D9/432
 D681,450 S * 5/2013 Wichmann D9/432
 D682,116 S 5/2013 Sina
 D684,466 S * 6/2013 Wichmann D9/432
 D688,126 S * 8/2013 Snedden D9/435
 D688,941 S * 9/2013 Sifuentes D9/432
 D690,194 S * 9/2013 Snedden D9/425
 D691,038 S 10/2013 Tyberghein
 D696,559 S 12/2013 Song
 D697,763 S 1/2014 Carlson
 D697,764 S 1/2014 Carlson
 D707,120 S 6/2014 Tyberghein
 D708,898 S 7/2014 Carlson
 D708,899 S 7/2014 Carlson
 D710,146 S 8/2014 Carlson
 D711,220 S 8/2014 Tyberghein
 D716,613 S 11/2014 Carlson
 D717,120 S 11/2014 Carlson
 D717,121 S 11/2014 Carlson
 D717,122 S 11/2014 Carlson
 D723,339 S 3/2015 Maxwell et al.
 D730,112 S 5/2015 Yessin et al.
 D730,127 S 5/2015 Maxwell et al.
 D739,231 S * 9/2015 Snedden D9/425
 D742,224 S 11/2015 Thurin et al.
 D750,423 S 3/2016 Shirley et al.
 D750,425 S 3/2016 Shirley et al.
 D751,335 S * 3/2016 Shirley D7/391
 D751,349 S 3/2016 Carlson
 D752,973 S 4/2016 Thurin et al.
 D759,427 S 6/2016 Wiggins
 D759,478 S 6/2016 Fife et al.
 D760,073 S 6/2016 Mather et al.
 D765,503 S 9/2016 Shiffer et al.
 D772,058 S * 11/2016 Urushidani D9/432
 D778,154 S 2/2017 Strachan
 D778,155 S 2/2017 Strachan
 D787,930 S 5/2017 Buck et al.
 D801,808 S * 11/2017 Irimia D9/432

D811,212 S 2/2018 Pickard et al.
 D850,218 S 6/2019 Lum et al.
 D864,667 S * 10/2019 Shirley D7/545
 D900,602 S * 11/2020 Hartley D9/432
 D918,671 S 5/2021 Souza et al.
 D926,564 S * 8/2021 Pessagno D9/425
 2007/0119743 A1 * 5/2007 Tucker B65D 21/0223
 206/503
 2009/0084796 A1 * 4/2009 Coonce B65D 43/0208
 220/508
 2011/0114638 A1 * 5/2011 Kettner B65D 43/021
 220/260
 2012/0048874 A1 * 3/2012 Oakes B65D 21/064
 220/839
 2014/0284346 A1 * 9/2014 McCumber B65D 43/162
 220/792
 2021/0002037 A1 * 1/2021 Marino B65D 1/22

FOREIGN PATENT DOCUMENTS

EM 001259295-0009 2/2011
 EM 001259295-0010 2/2011
 EM 001259295-0012 2/2011
 EM 002173245-0014 1/2013
 EM 001388789-0001 10/2013
 EM 002611491-0002 1/2015
 EM 002611640-0002 1/2015
 EM 003432178-0001 10/2016
 EM 003517556-0001 12/2016
 JP 2004075123 A 3/2004
 WO WO 200691471 A2 8/2006

OTHER PUBLICATIONS

Ziploc(R) Brand Snap 'N Seal containers. Published on Jun. 4, 2021. Visited Sep. 24, 2021. <https://www.youtube.com/watch?v=DghHWzAigJI> (Year: 2021).*

De-clutter Your Kitchen with Magnetic Spice Storage Using Ziploc(R) Containers. Published on Dec. 12, 2016. Visited Sep. 24, 2021. <https://www.youtube.com/watch?v=RsBdbGL2tbA> (Year: 2016).*

Amazon. Ziploc Food Storage Meal Prep Containers Images. Latest modified date Apr. 5, 2021. Visited Feb. 7, 2022. All images taken from <https://www.amazon.com/Ziploc-Containers-Variety-Pack-Count/dp/B01IH2TRI8> (Year: 2021).*

Wayback Machine. Ziploc Containers. Archived May 9, 2021. Visited Feb. 7, 2022. <https://web.archive.org/web/20210509002354/https://ziploc.com/en/products/containers> (Year: 2021).*

Wayback Machine. Ziploc Containers. Archived Jun. 8, 2021. Visited Feb. 7, 2022. <https://web.archive.org/web/20210608035714/https://ziploc.com/en/products/containers> (Year: 2021).*

Glad, Glad Gladware Entrée Plastic Square Containers with Lids, 25 Ounce, 5 Count (Pack of 1), Amazon.com, available at least as early as Dec. 20, 2019, https://www.amazon.com/Glad-Gladware-Entree-Plastic-Containers/dp/B004IAE1WQ/ref=sr_1_1?crd=3FYRTSTIYSOUC&keywords=glad+gladware+entree+plastic+square+containers+with+lids%2C+25+ounce&qid=1582556518&srefix=glad+gladware+entree%2Caps%2C125&sr=8-1.

* cited by examiner

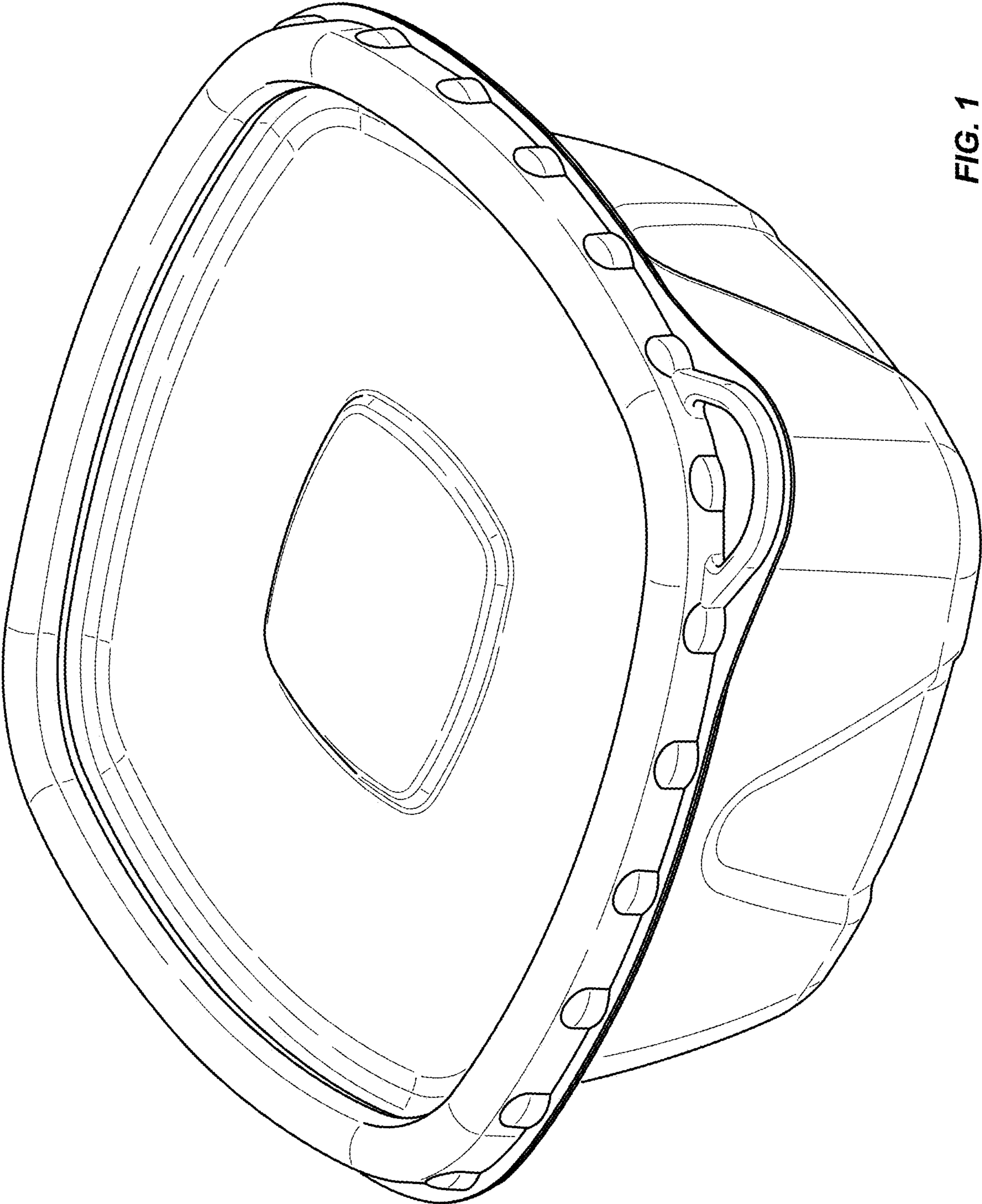

FIG. 1

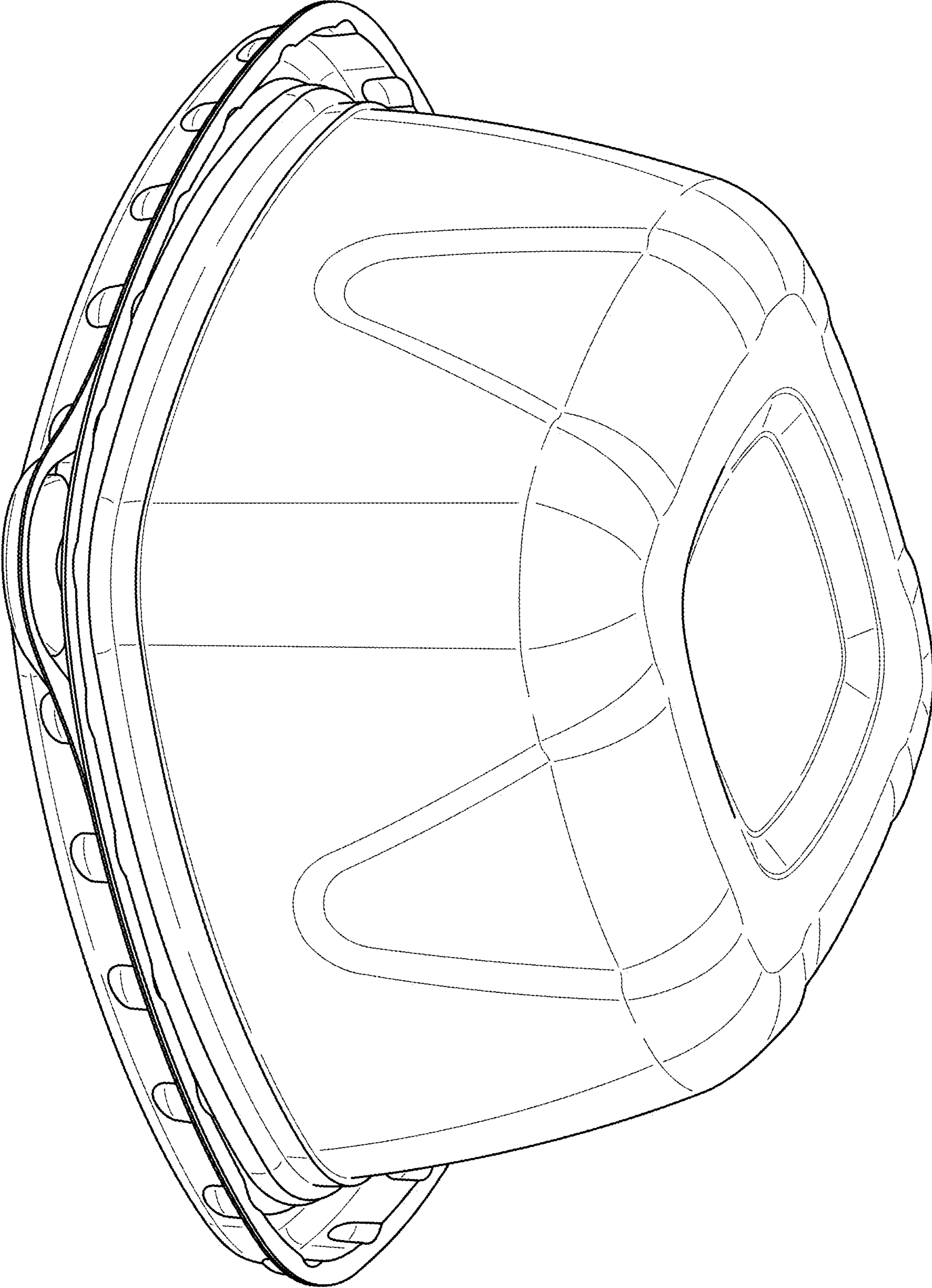

FIG. 2

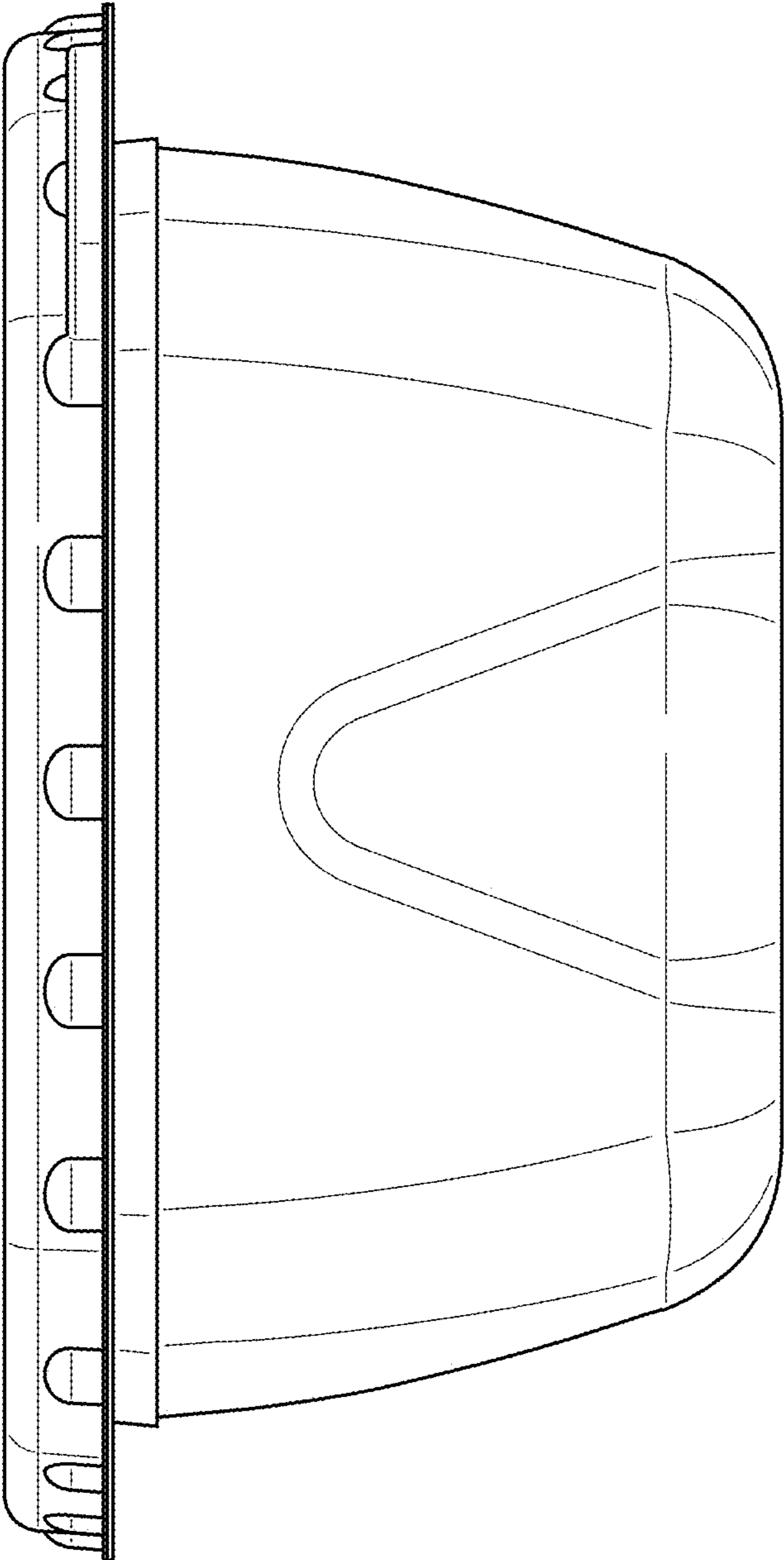

FIG. 3

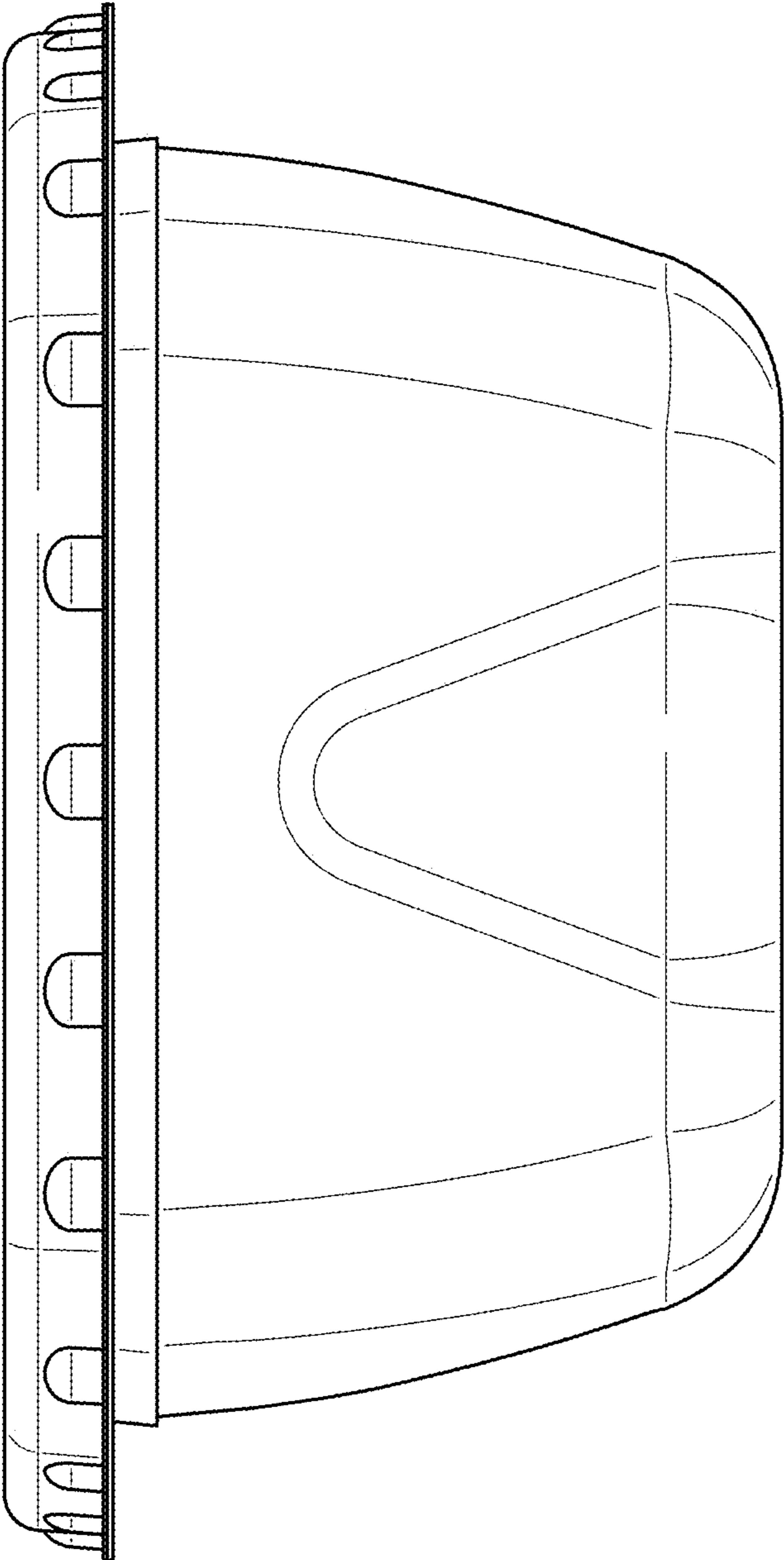

FIG. 4

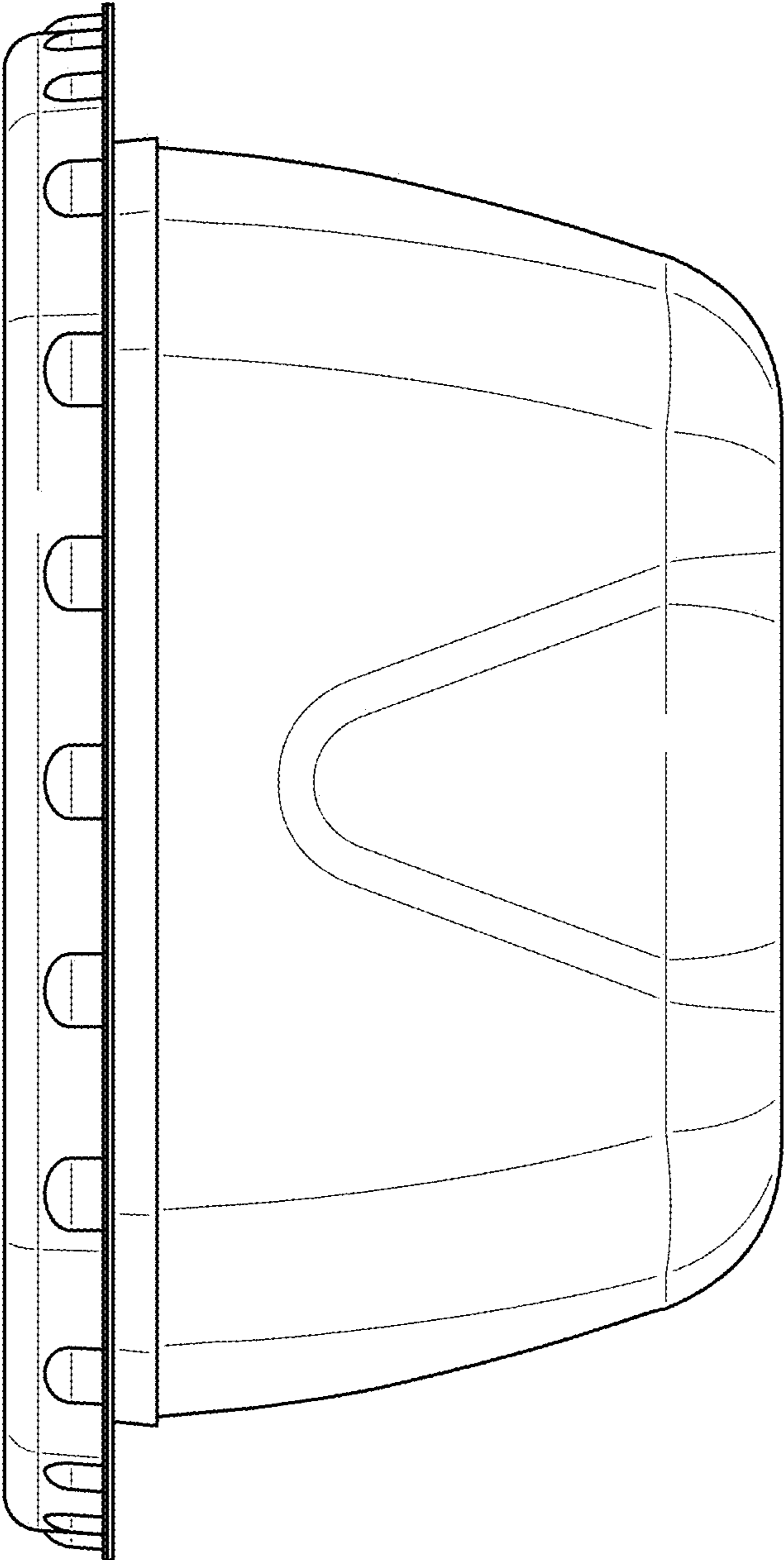

FIG. 5

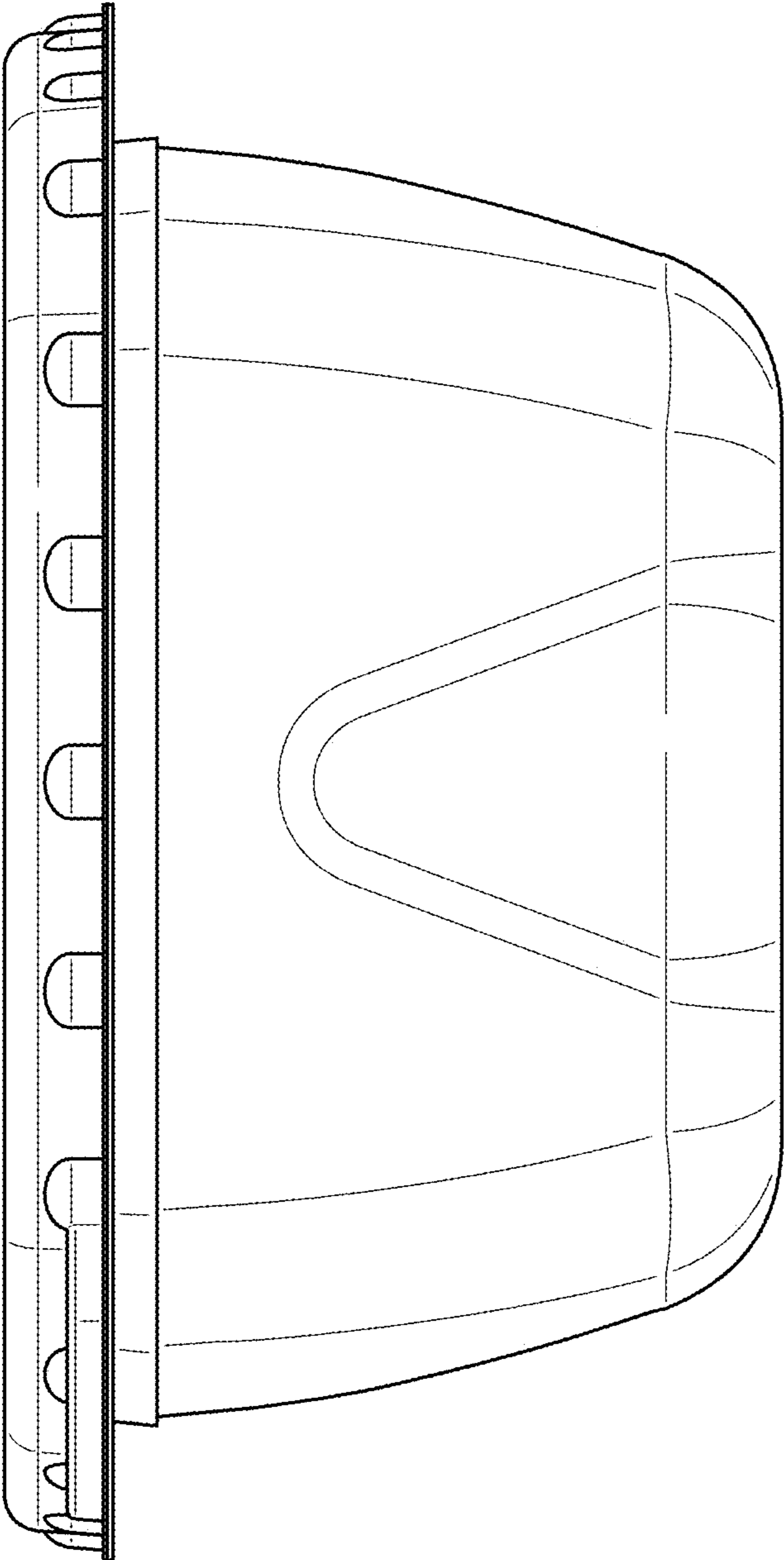
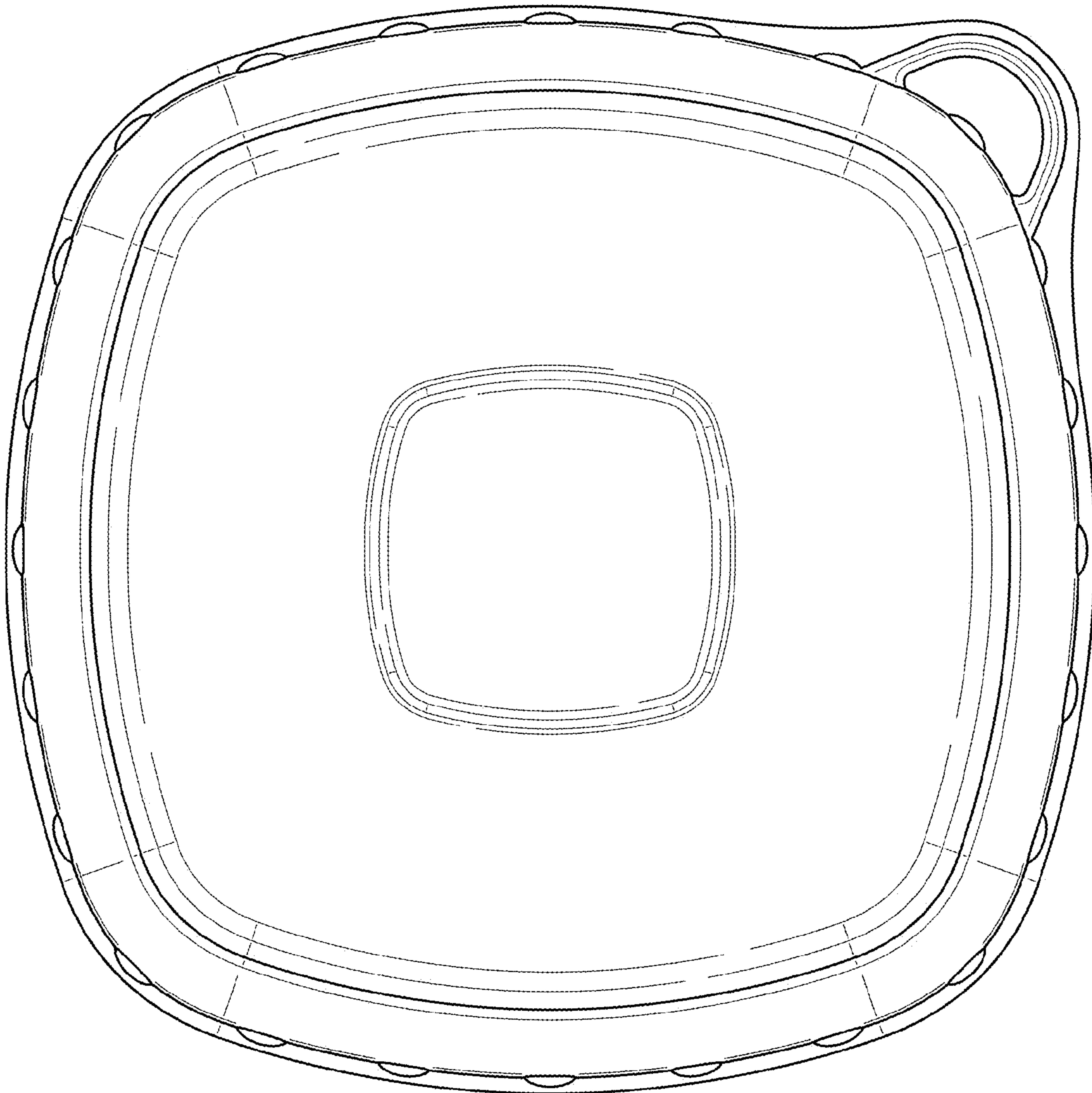

FIG. 6

FIG. 7



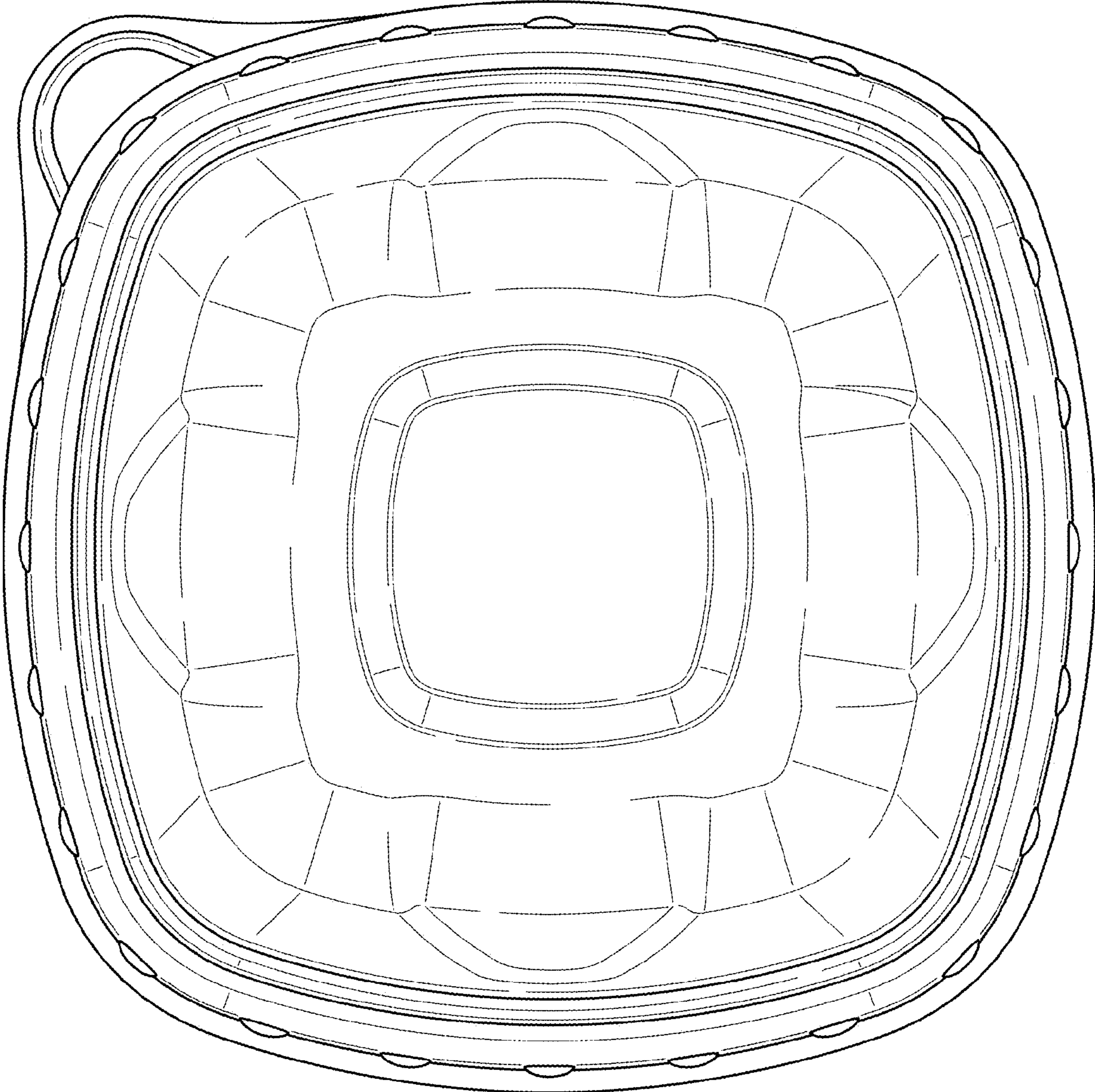

FIG. 8