



US00D955784S

(12) **United States Design Patent**
Jensen

(10) **Patent No.:** **US D955,784 S**

(45) **Date of Patent:** **** Jun. 28, 2022**

(54) **NECK SUPPORT PILLOW**

D858,143 S * 9/2019 Tu A47C 7/383
D6/601

(71) Applicant: **Gemma Jensen**, Altrincham (GB)

10,881,213 B2 * 1/2021 Jensen A47C 7/383
2014/0345057 A1 * 11/2014 Jensen A47C 7/383

(72) Inventor: **Gemma Jensen**, Altrincham (GB)

5/636

(**) Term: **15 Years**

(Continued)

(21) Appl. No.: **29/734,902**

Primary Examiner — Jennifer L Rempfer

(22) Filed: **May 15, 2020**

(74) *Attorney, Agent, or Firm* — Craft Chu PLLC;
Andrew W. Chu

(30) **Foreign Application Priority Data**

(57) **CLAIM**

The ornamental design for a neck support pillow, as shown and described.

Nov. 15, 2019 (EM) 007243860-0004

DESCRIPTION

(51) **LOC (13) Cl.** **06-09**

(52) **U.S. Cl.**
USPC **D6/601**

(58) **Field of Classification Search**
USPC D6/582–583, 587–592, 595–609,
D6/617–622; D21/803–809; D24/183
CPC A47G 9/00; A47G 2009/001; A47G
2009/002; A47G 2009/003; A47G 9/10;
A47G 9/1009; A47G 2009/1018; A47G
9/1045; A47G 9/1081; A47G 9/109
See application file for complete search history.

FIG. 1 is a side perspective view of the neck support pillow showing my design with a loop and scarf in broken line portions and a dashed seam line.

FIG. 2 is a front elevation view thereof showing the loop and scarf in broken line portions and a dashed seam line;

FIG. 3 is a back elevation view showing a strip pattern, the loop and scarf in broken line portions and dashed seam lines;

FIG. 4 is a back elevation view showing the loop in a broken line portion and a dashed seam line;

FIG. 5 is a side elevation view thereof, showing the loop and scarf in broken line portions and a dashed seam line;

FIG. 6 is an opposite side elevation view thereof, showing the loop and scarf in broken line portions and a dashed seam line;

FIG. 7 is a top plan view thereof, showing the strip pattern, the loop and scarf in broken line portions and dashed seam lines; and,

FIG. 8 is a bottom plan view thereof, showing the strip pattern, the loop and scarf in broken line portions and dashed seam lines.

The broken line portions in FIGS. 1-8, showing a strip pattern, a loop, and a scarf with optional holes, are presented for illustrative purposes and form no part of the claimed design.

(56) **References Cited**

U.S. PATENT DOCUMENTS

- D399,675 S * 10/1998 Ferris D6/601
- 6,795,990 B1 * 9/2004 Hutchinson D. C.
A47C 20/021
5/490
- 8,136,186 B1 * 3/2012 Leach A47C 27/086
5/631
- D675,807 S 2/2013 Alvarez
- D695,996 S 12/2013 Paul
- D716,582 S * 11/2014 Jensen D6/601
- D721,520 S * 1/2015 Jensen D6/601
- D741,042 S 10/2015 Paul
- D775,863 S * 1/2017 Jensen D6/601
- D836,287 S 12/2018 Melamed

1 Claim, 4 Drawing Sheets

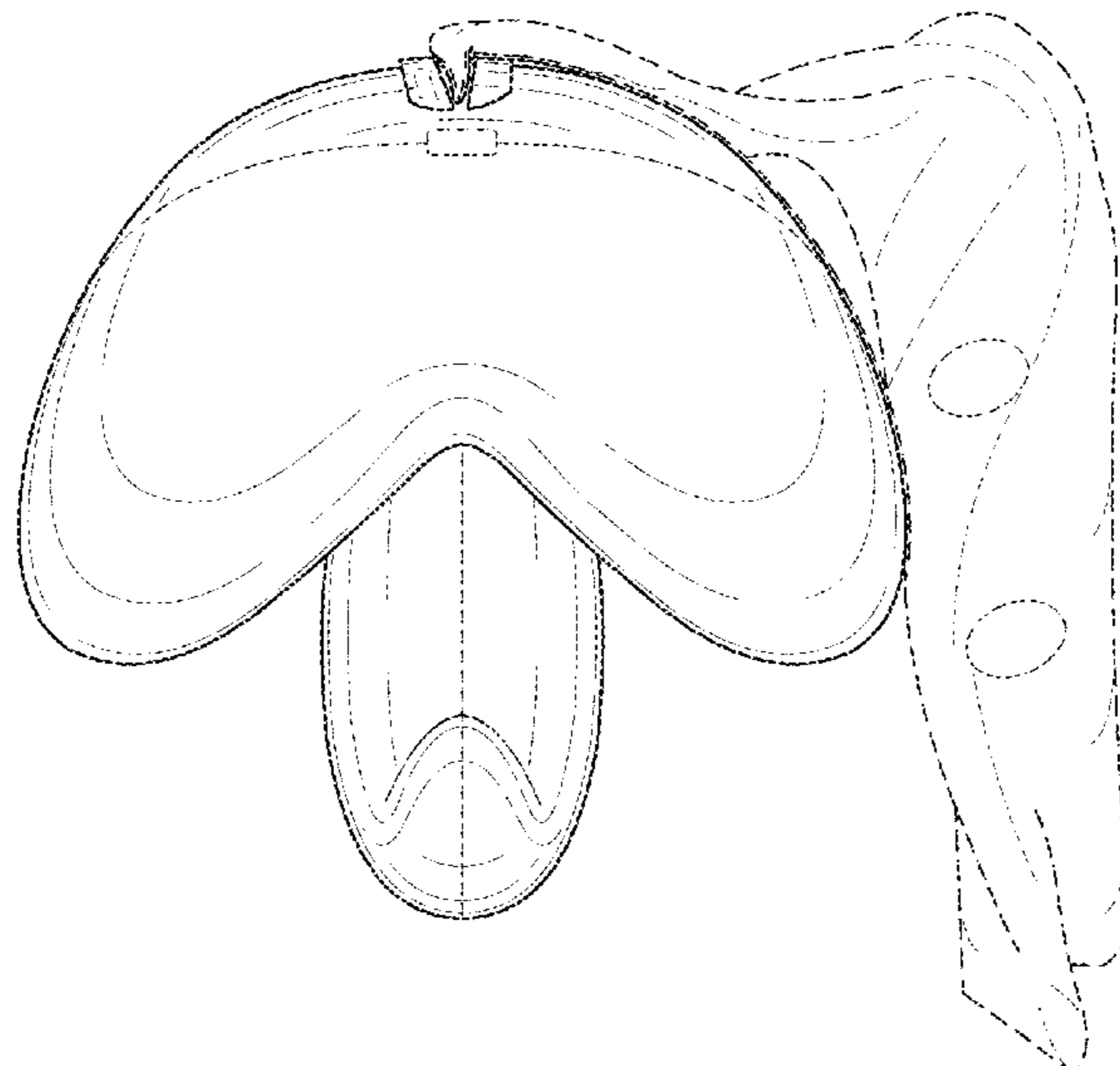

(56)

References Cited

U.S. PATENT DOCUMENTS

2016/0345760 A1* 12/2016 Pesale A47G 9/109

* cited by examiner

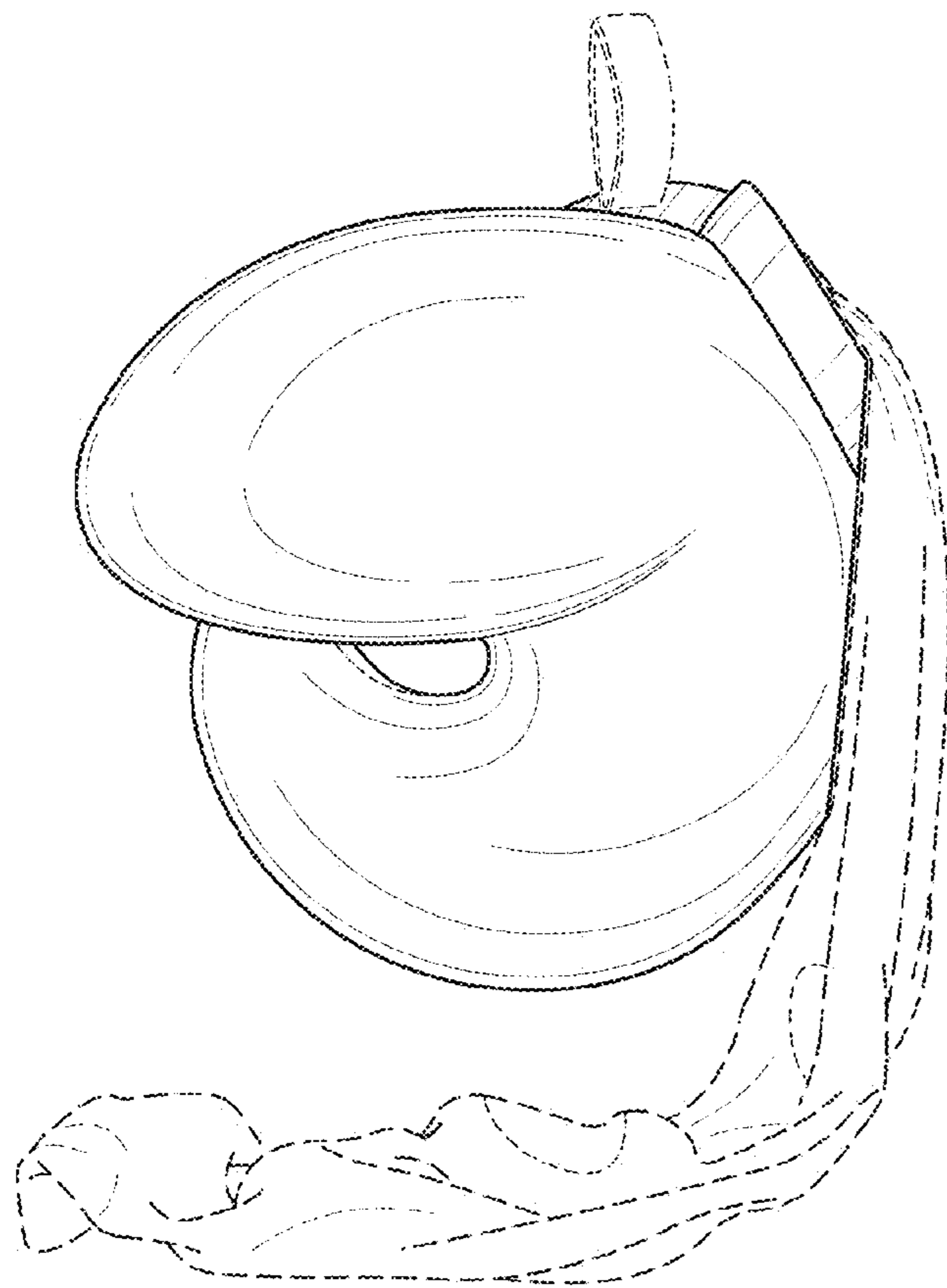

FIG. 1

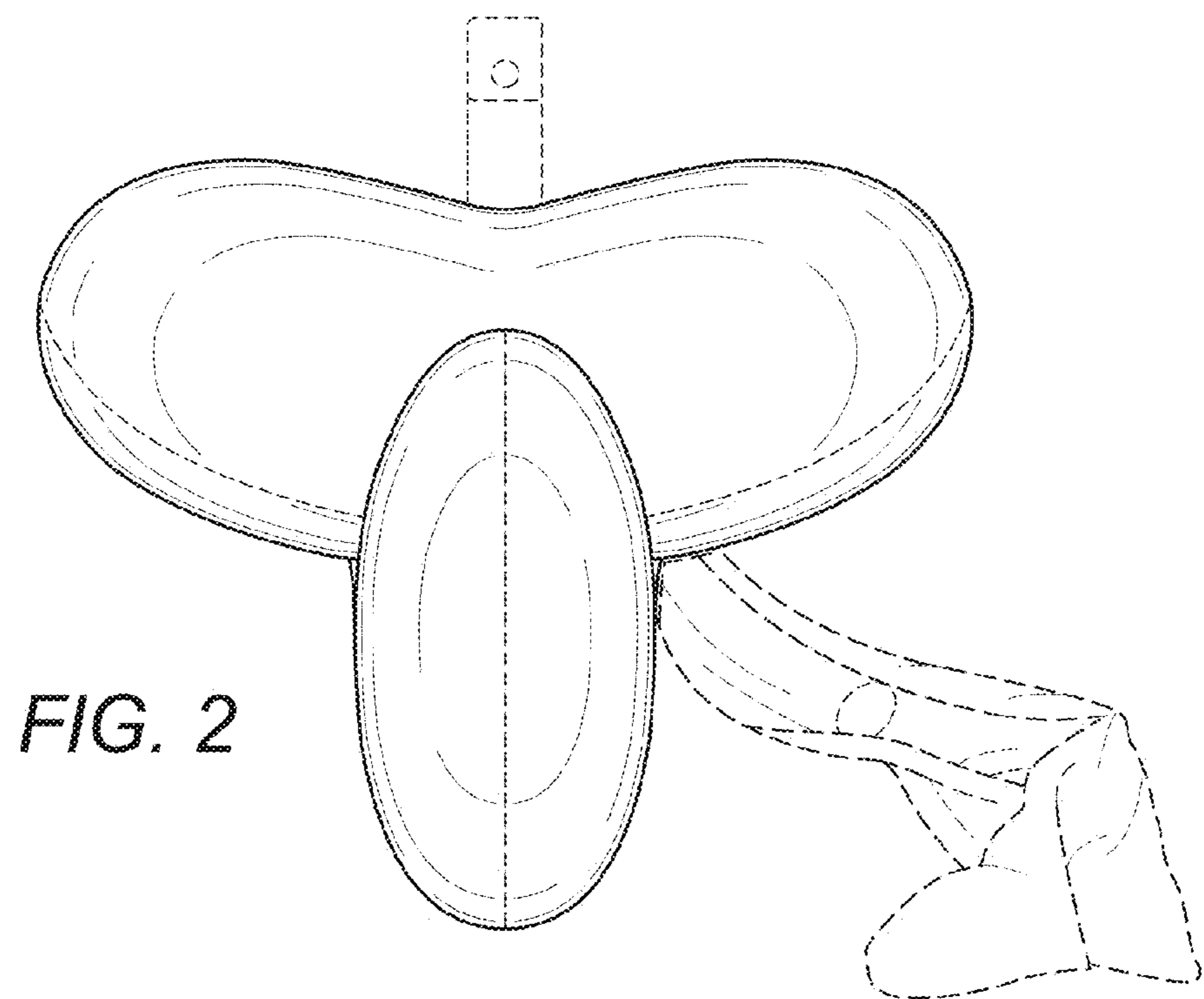

FIG. 2

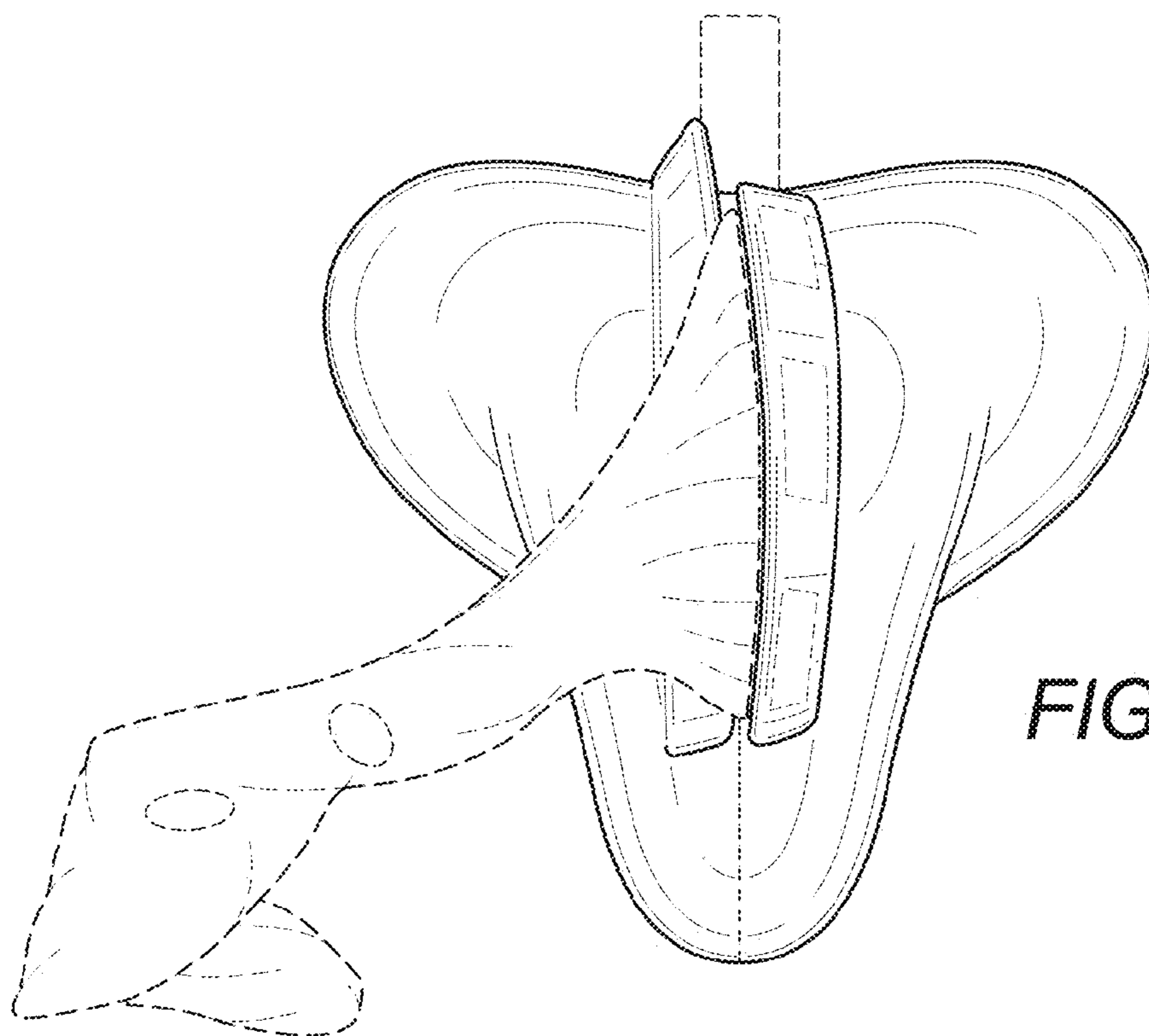

FIG. 3

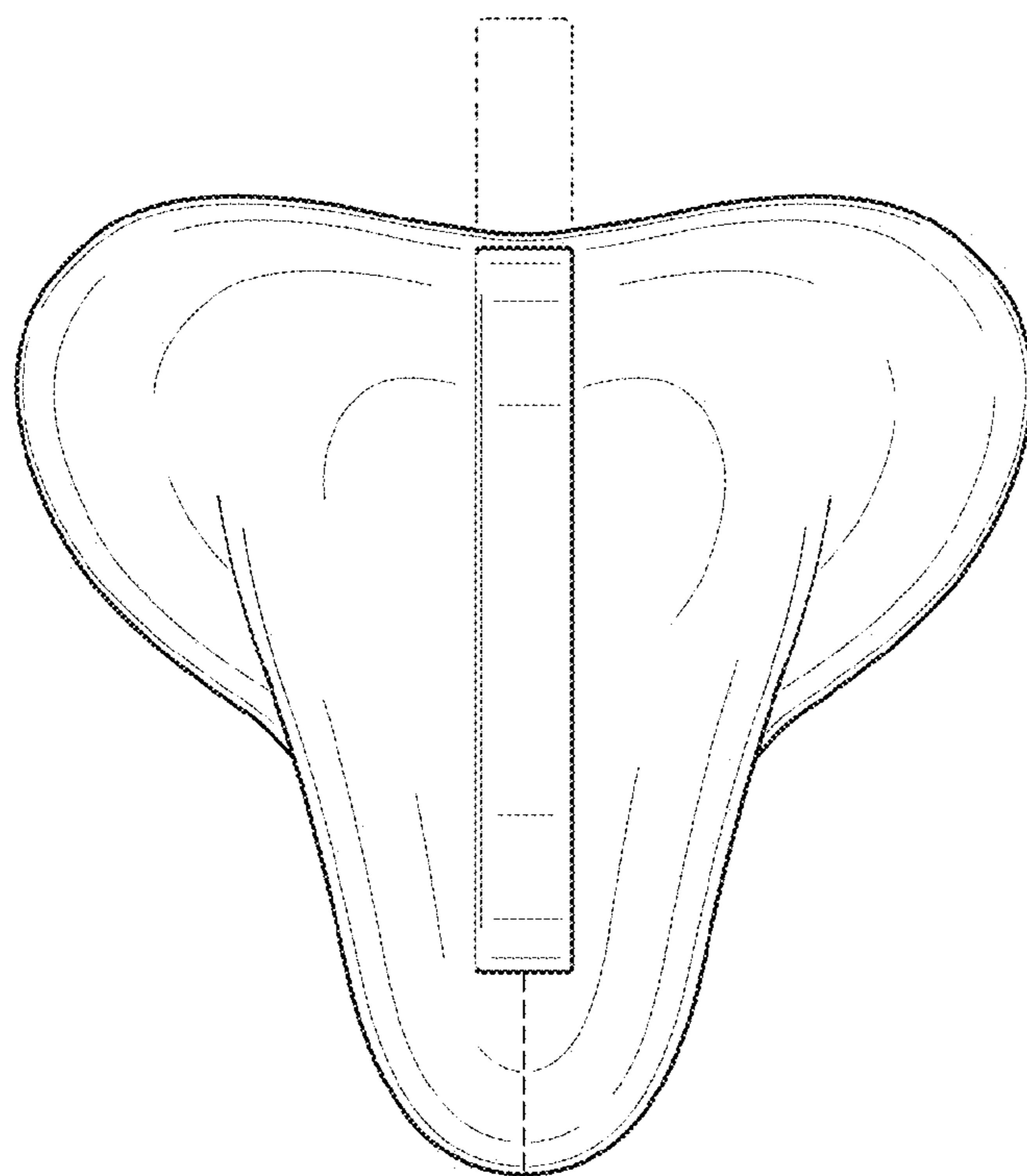

FIG. 4

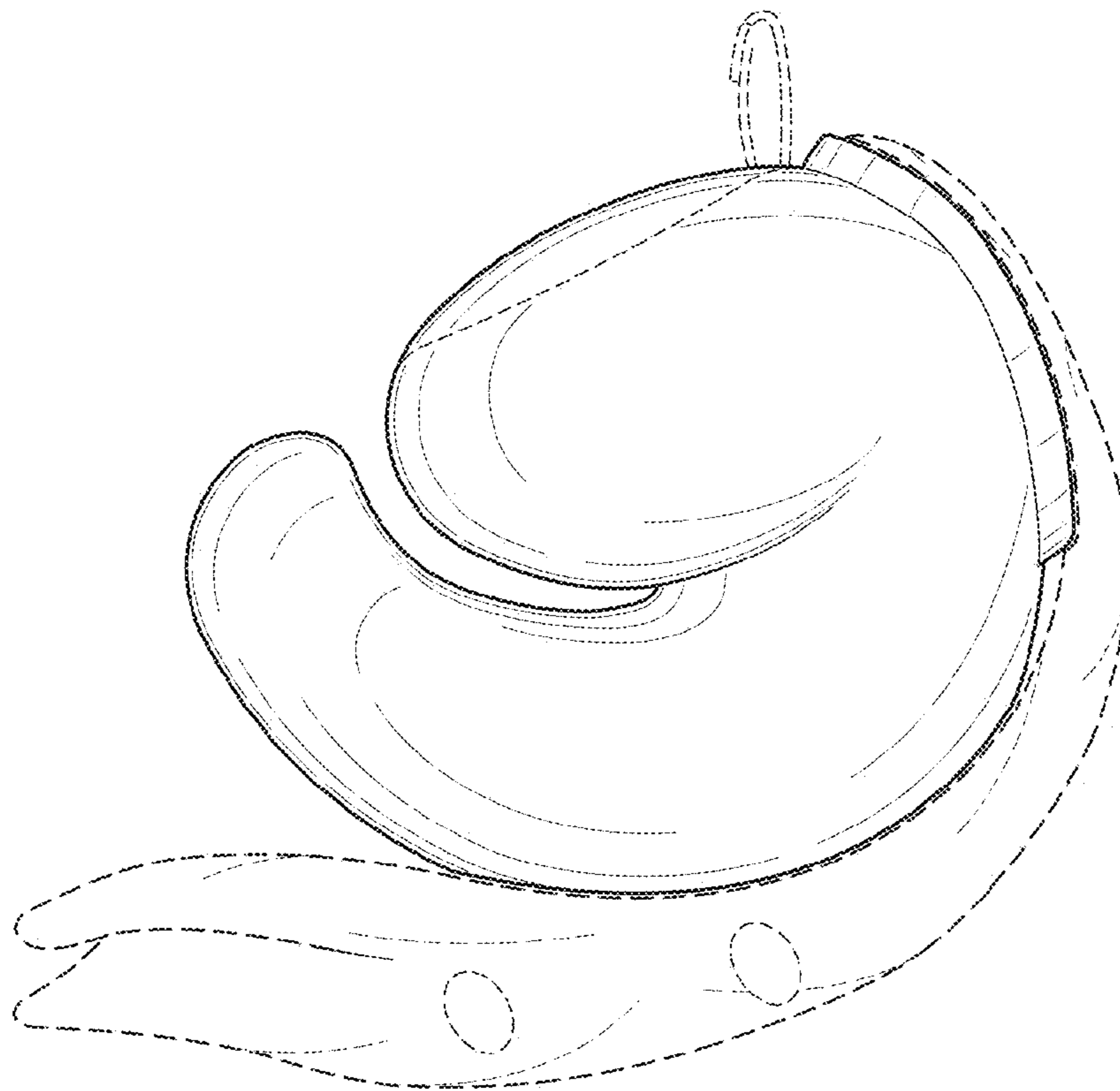

FIG. 5

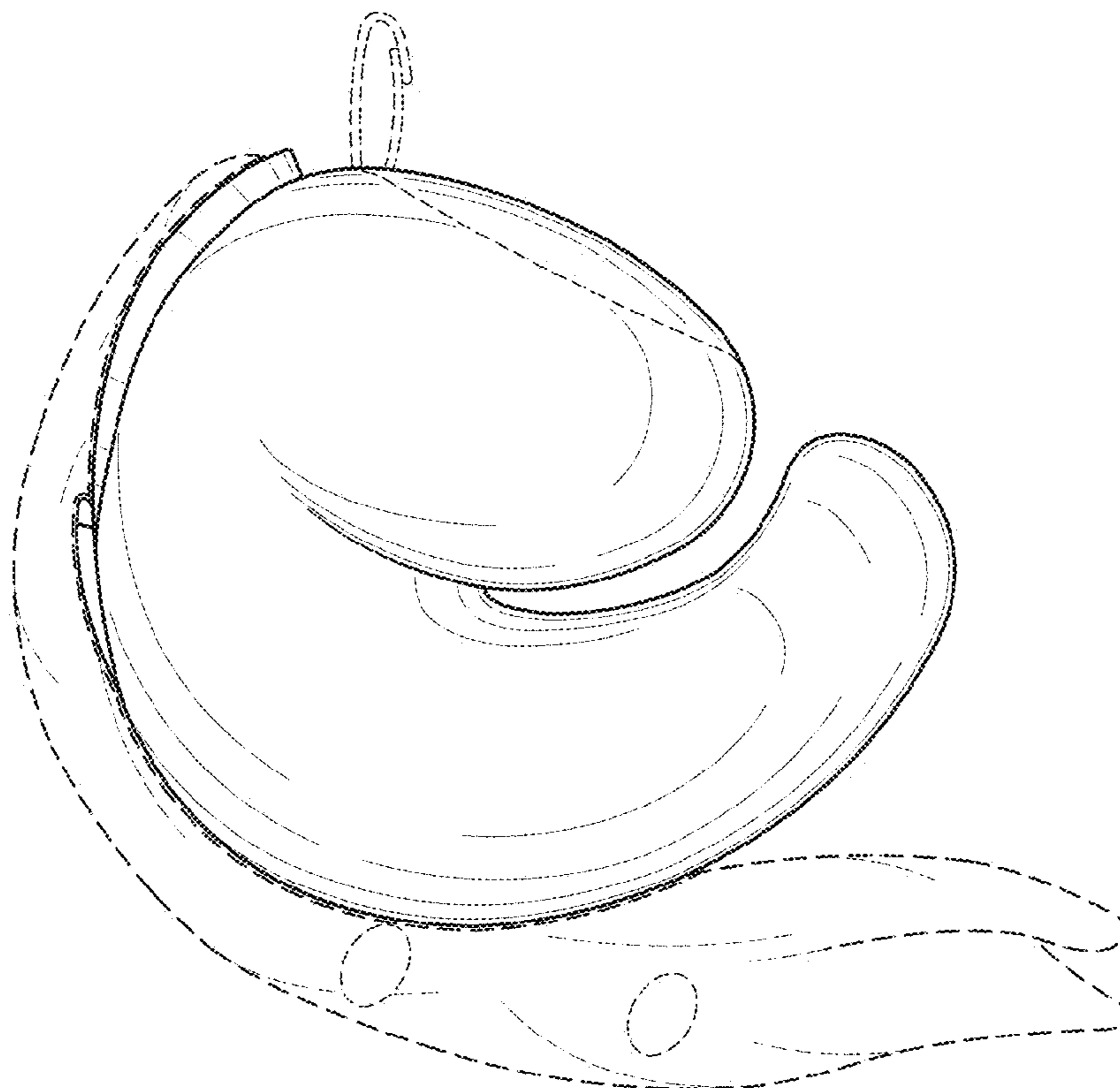

FIG. 6

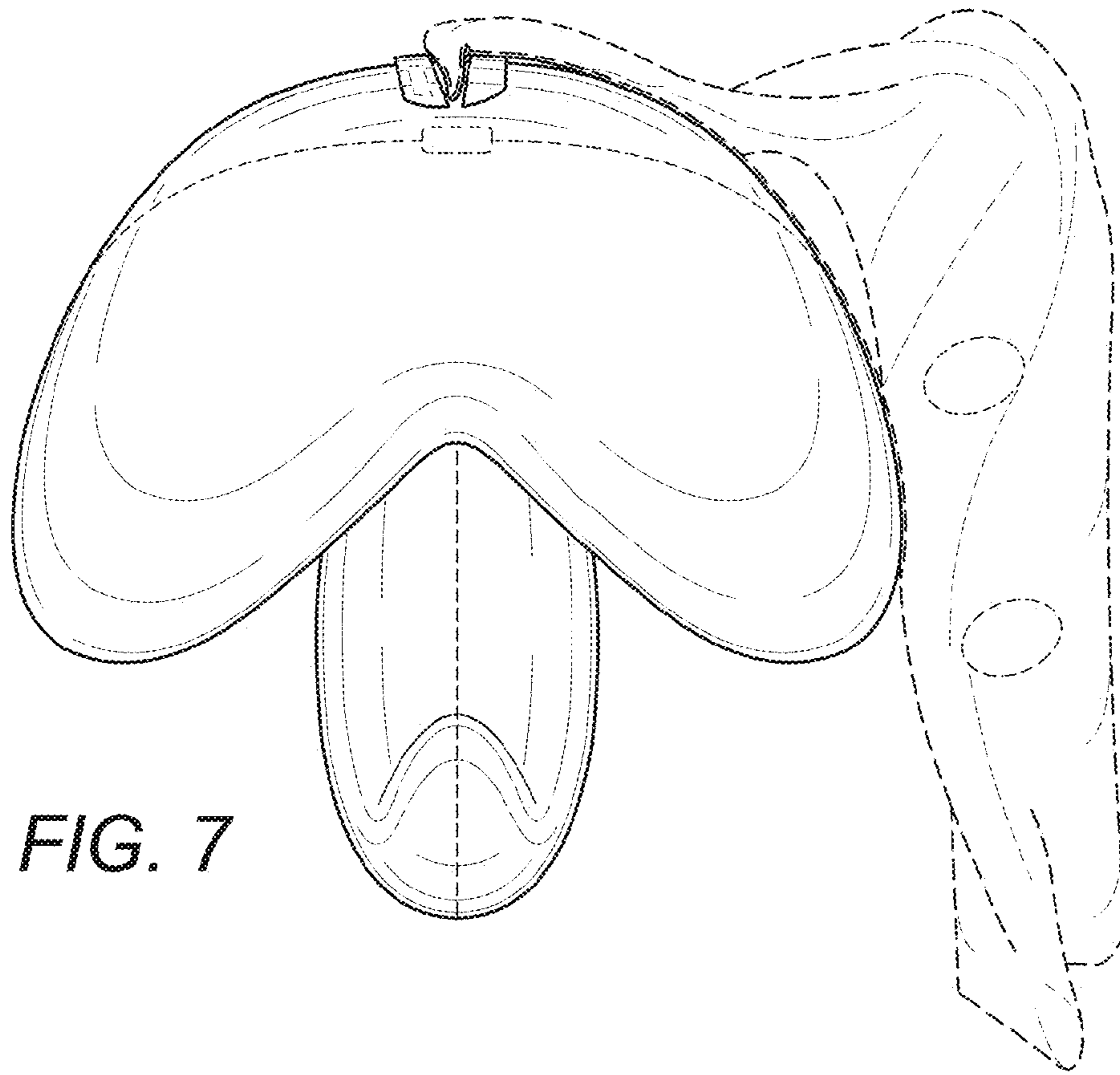

FIG. 7

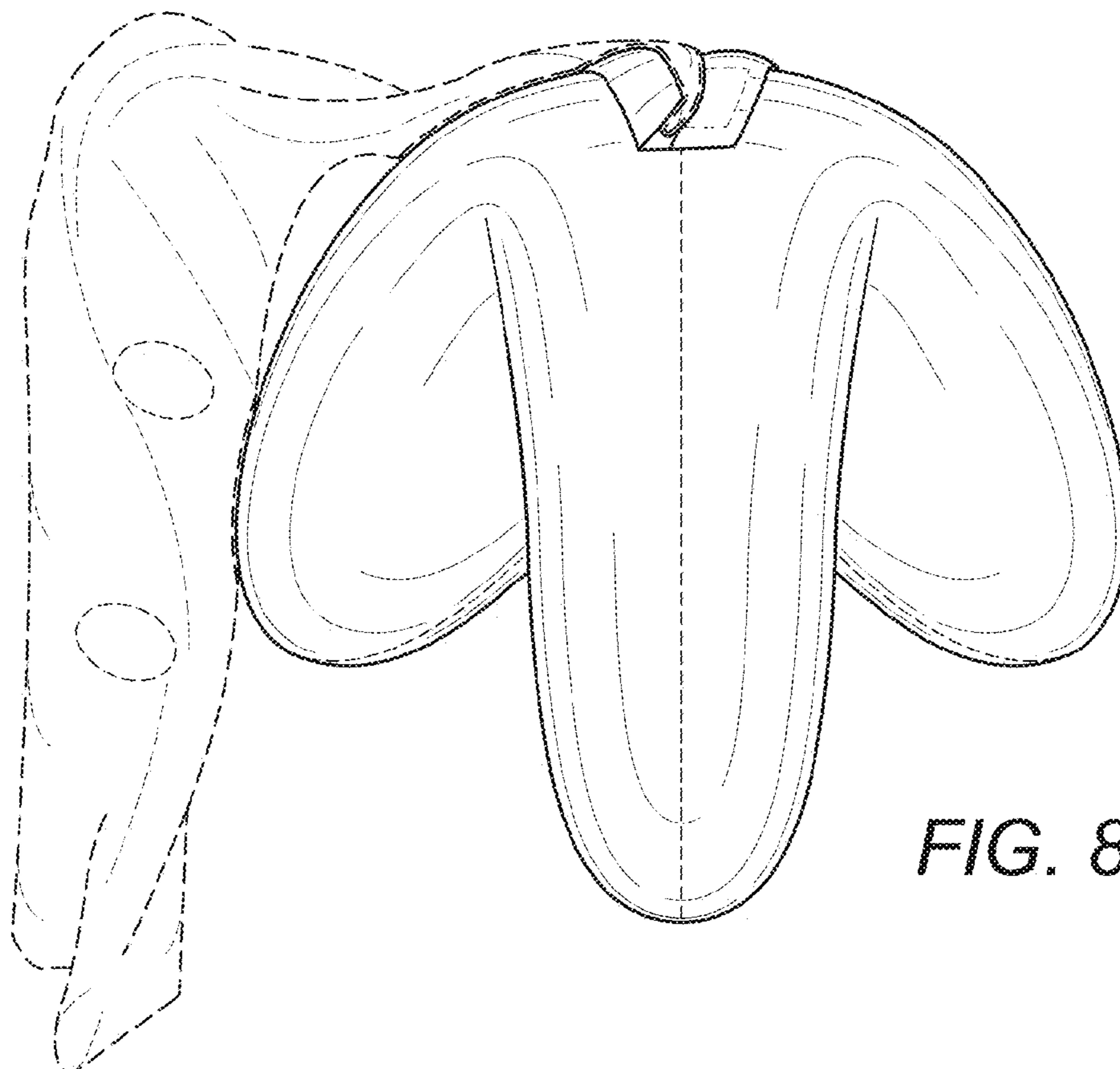

FIG. 8