



US00D955735S

(12) **United States Design Patent** (10) **Patent No.:** **US D955,735 S**
Li et al. (45) **Date of Patent:** **** Jun. 28, 2022**

(54) **COMPRESSION SOCK**
(71) Applicants: **Zhipeng Li**, Baldwin Park, CA (US);
Jinliang Zhang, Baldwin Park, CA (US)
(72) Inventors: **Zhipeng Li**, Baldwin Park, CA (US);
Jinliang Zhang, Baldwin Park, CA (US)
(73) Assignee: **Chongqing Qing Er Technology Co. Ltd.**, Chongqing (CN)

2014/0289924 A1* 10/2014 Cleveland A61F 13/08
2/2.5
2016/0076175 A1* 3/2016 Rock A61F 13/08
66/171
2017/0354543 A1* 12/2017 Mazourik A61H 1/008
2018/0303677 A1* 10/2018 Griffiths A61F 13/08
(Continued)

FOREIGN PATENT DOCUMENTS

CN 306339478 * 2/2021
EM 007430558-0001 * 1/2020

OTHER PUBLICATIONS

Colorful Striped Pattern Cycling Running Custom Knee High Athletic Socks, Alibaba.com, [Post Date unknown], [Site seen Oct. 20, 2021], Seen at URL: https://www.alibaba.com/product-detail/Colorful-Striped-Pattern-Cycling-Running-Custom_62192964664.html (Year: 2021).*

(Continued)

Primary Examiner — Natasha Vujcic
Assistant Examiner — Gilbert B Ford
(74) *Attorney, Agent, or Firm* — Tsz Lung Yeung

(**) Term: **15 Years**
(21) Appl. No.: **29/733,942**
(22) Filed: **May 7, 2020**
(51) **LOC (13) Cl.** **24-02**
(52) **U.S. Cl.**
USPC **D2/980; D2/994; D24/192**
(58) **Field of Classification Search**
USPC D2/980–994; D24/190, 192
CPC A61F 13/085; A61F 13/08; A41B 11/02;
A61H 2205/10; A61H 2205/108; A41D
13/0543; D04B 1/265
See application file for complete search history.

(57) **CLAIM**

The ornamental design for a compression sock, as shown and described.

(56) **References Cited**

U.S. PATENT DOCUMENTS

D171,951 S * 4/1954 Nolan D2/987
D650,574 S * 12/2011 Loth D2/980
D740,014 S * 10/2015 Amis D2/994
D747,601 S * 1/2016 Middleton D2/980
D849,390 S * 5/2019 Abdul-Malik D2/980
D872,453 S * 1/2020 Durisch D2/994
D872,457 S * 1/2020 Durisch D2/994
D896,498 S * 9/2020 Lin D2/994
D903,295 S * 12/2020 Moon D2/994
2008/0249454 A1* 10/2008 Mills A61F 13/08
602/63
2012/0102613 A1* 5/2012 Loth A41D 13/0543
2/22

DESCRIPTION

FIG. 1 is a perspective view of a compression sock in an in-use configuration for right leg, showing my new design; FIG. 2 is a front view thereof; FIG. 3 is a rear view thereof; FIG. 4 is a right side view thereof; FIG. 5 is a left side view thereof; and, FIG. 6 is a bottom view thereof. The broken lines depict portions of the compression sock that form no part of the claimed design.

1 Claim, 6 Drawing Sheets

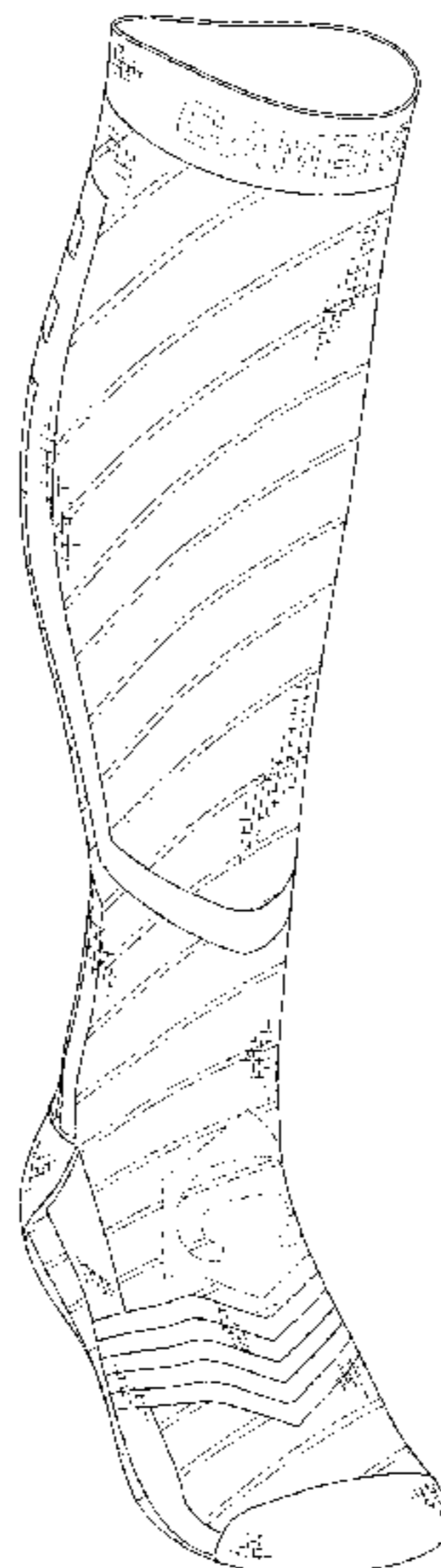

(56)

References Cited

U.S. PATENT DOCUMENTS

2019/0015259 A1* 1/2019 Stein D04B 1/265
2020/0347530 A1* 11/2020 Tannebaum D04B 1/26

OTHER PUBLICATIONS

Cambivo | Compression Socks And Knee Brace |, youtube, [Post Date May 12, 2018], [Site seen Oct. 20, 2021], Seen at URL: <https://www.youtube.com/watch?v=ElmFBsGkLws> (Year: 2018).*

ZFiSt 3Pair Medical Sport Compression Socks Men,20-30mmhg Run Nurse Socks for Edema Diabetic Varicose Veins, Amazon, [Post Date Apr. 7, 2018], [Site seen Oct. 20, 2021], Seen at URL: <https://amzn.to/2Z4WKw3> (Year: 2018).*

* cited by examiner

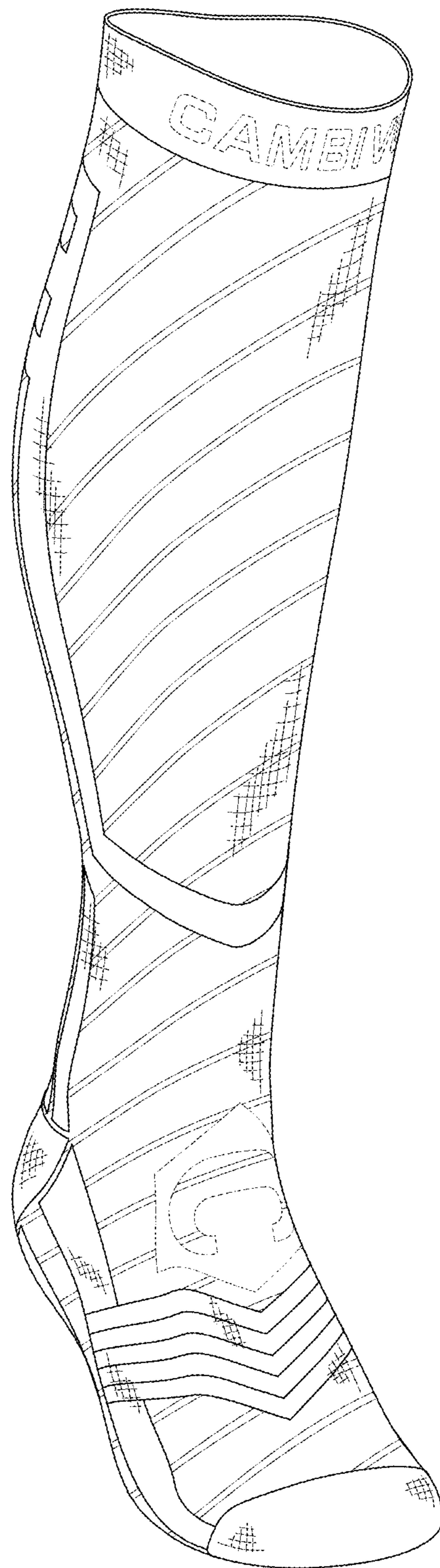

FIG.1

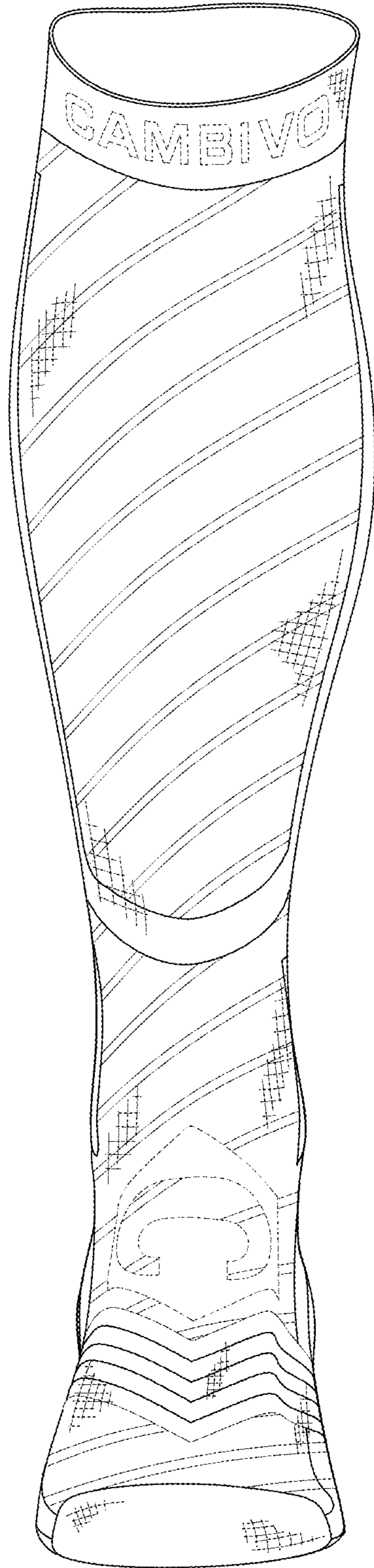

FIG. 2

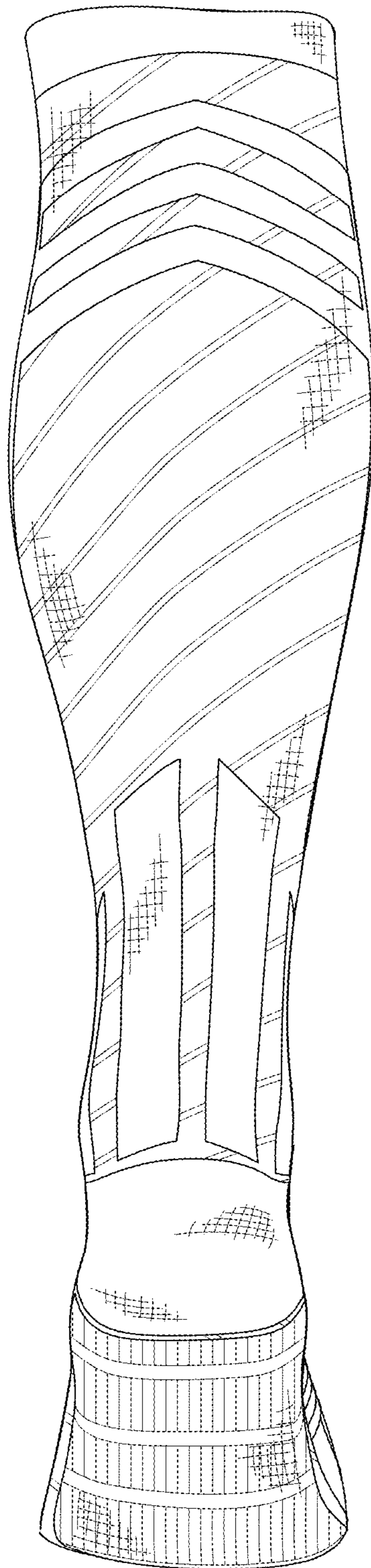

FIG. 3

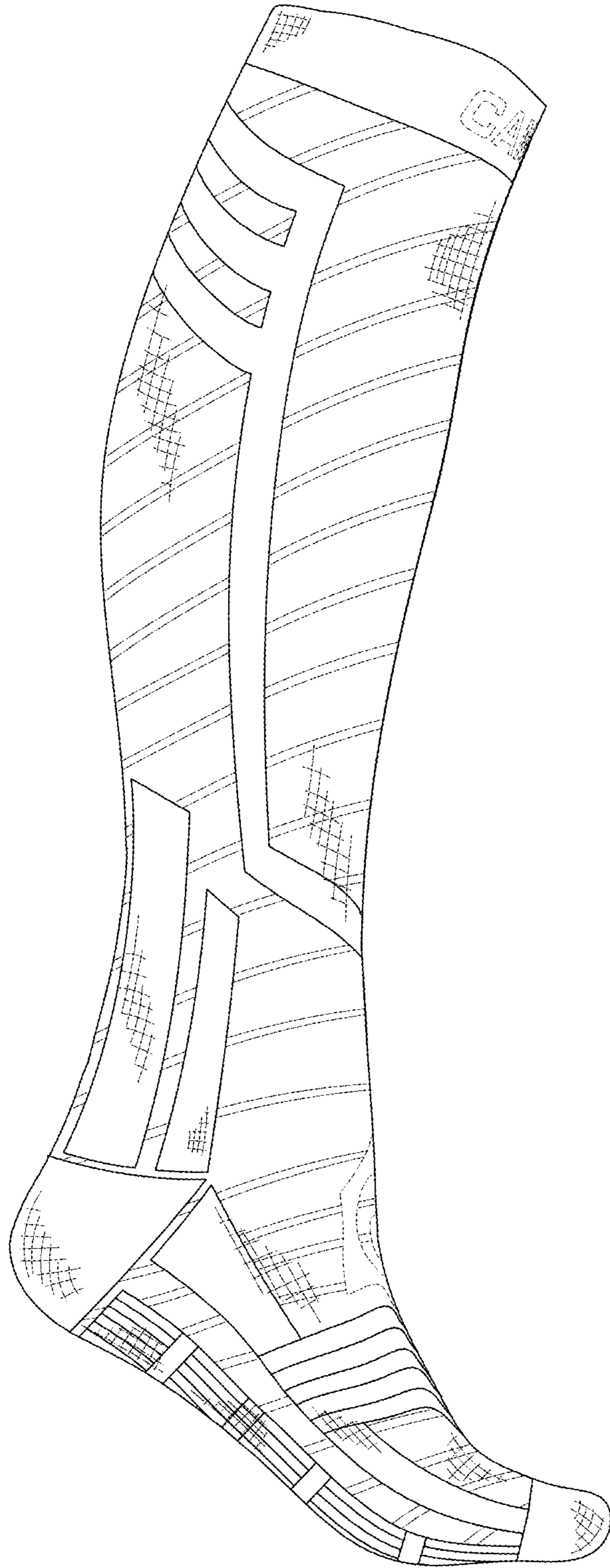

FIG. 4

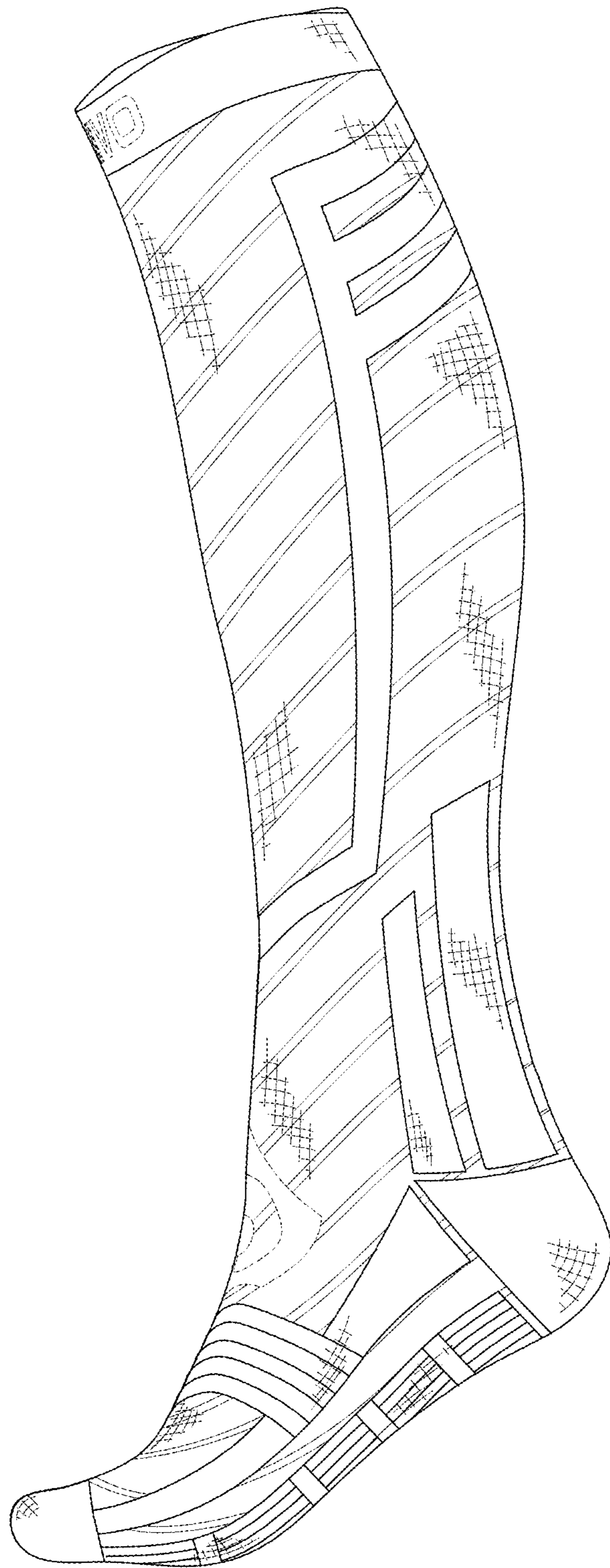

FIG. 5

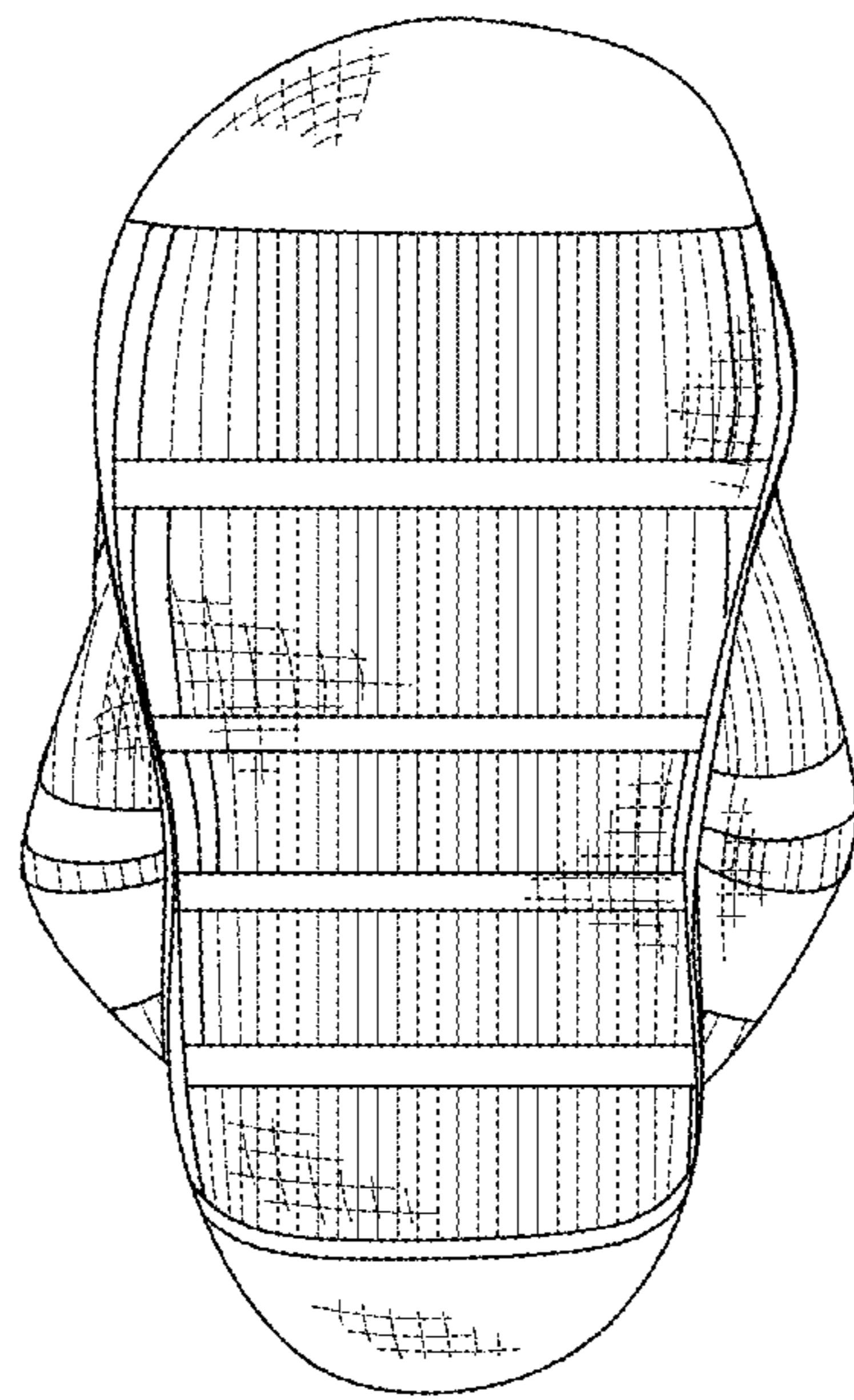

FIG.6