



US00D955677S

(12) **United States Design Patent**
Chen

(10) **Patent No.:** **US D955,677 S**
(45) **Date of Patent:** **** Jun. 21, 2022**

(54) **TOUCH BIN**
(71) Applicant: **EKO DEVELOPMENT LTD.,**
Guangzhou (CN)
(72) Inventor: **Yizhi Chen,** Guangzhou (CN)
(73) Assignee: **EKO Development Ltd.,** Guangdong
(CN)
(**) Term: **15 Years**

D472,688 S 4/2003 Lin
D482,169 S 11/2003 Lin
D488,903 S 4/2004 Yang et al.
D491,706 S 6/2004 Yang et al.
D513,103 S 12/2005 Lin
D513,445 S 1/2006 Lin
6,981,606 B2 1/2006 Yang et al.
D517,763 S 3/2006 Daams
D517,767 S 3/2006 Yang et al.
D525,756 S 7/2006 Yang et al.
D527,155 S 8/2006 Frankhauser
(Continued)

(21) Appl. No.: **29/753,352**
(22) Filed: **Sep. 30, 2020**
(51) **LOC (13) Cl.** **09-09**
(52) **U.S. Cl.**
USPC **D34/7**
(58) **Field of Classification Search**
USPC D34/1, 7, 8, 9, 10, 11
CPC B65F 1/163; B65F 1/1438; B65F 1/162;
B65F 1/16; B65F 1/23; B65F 1/004;
B65F 1/1473; B65F 1/002; B65F 1/04;
B65F 1/1638; B65F 2240/138; B65F
2230/134
See application file for complete search history.

OTHER PUBLICATIONS

Qubyk.co.uk Feb. 8, 2022, 60l Stainless Steel Sensor Bin Rubbish
Trash Bins, <https://qubyk.co.uk/nav/home-and-living/kitchen/kitchen-cleaning/product/60l-stainless-steel-sensor-bin-rubbish-trash-bins-motion-automatic-ac-adaptor/92d649c1-3cdc-4c0a-a183-f488edc933f7> (Year: 2022).*
(Continued)

Primary Examiner — Cynthia Ramirez
(74) *Attorney, Agent, or Firm* — William H. Dippert;
Laurence A. Greenberg; Werner H. Stemer

(56) **References Cited**

U.S. PATENT DOCUMENTS

D215,617 S 10/1969 Heck
D246,090 S 10/1977 Gault
D250,744 S 1/1979 Morin
D333,542 S 2/1993 McKenzie
D335,562 S 5/1993 Evans
5,242,074 A 9/1993 Conaway et al.
D342,817 S 12/1993 Lippisch et al.
D343,709 S 1/1994 Doty et al.
5,531,348 A 7/1996 Baker et al.
D380,613 S 7/1997 Apps et al.
D437,384 S 2/2001 Fletcher et al.
D447,611 S 9/2001 Lin
6,345,725 B1 2/2002 Lin
D472,357 S 3/2003 Stewart

(57) **CLAIM**
The ornamental design for a touch bin, as shown and described.

DESCRIPTION

FIG. 1 is a perspective view of a touch bin, showing my new design.
FIG. 2 is a top plan view thereof.
FIG. 3 is a left-side elevation view thereof.
FIG. 4 is a front elevation view thereof.
FIG. 5 is a right-side elevation view thereof.
FIG. 6 is a bottom plan view thereof; and,
FIG. 7 is a rear elevation view thereof.
The broken lines in the drawings depict portions of the touch bin that form no part of the claimed design.

1 Claim, 7 Drawing Sheets

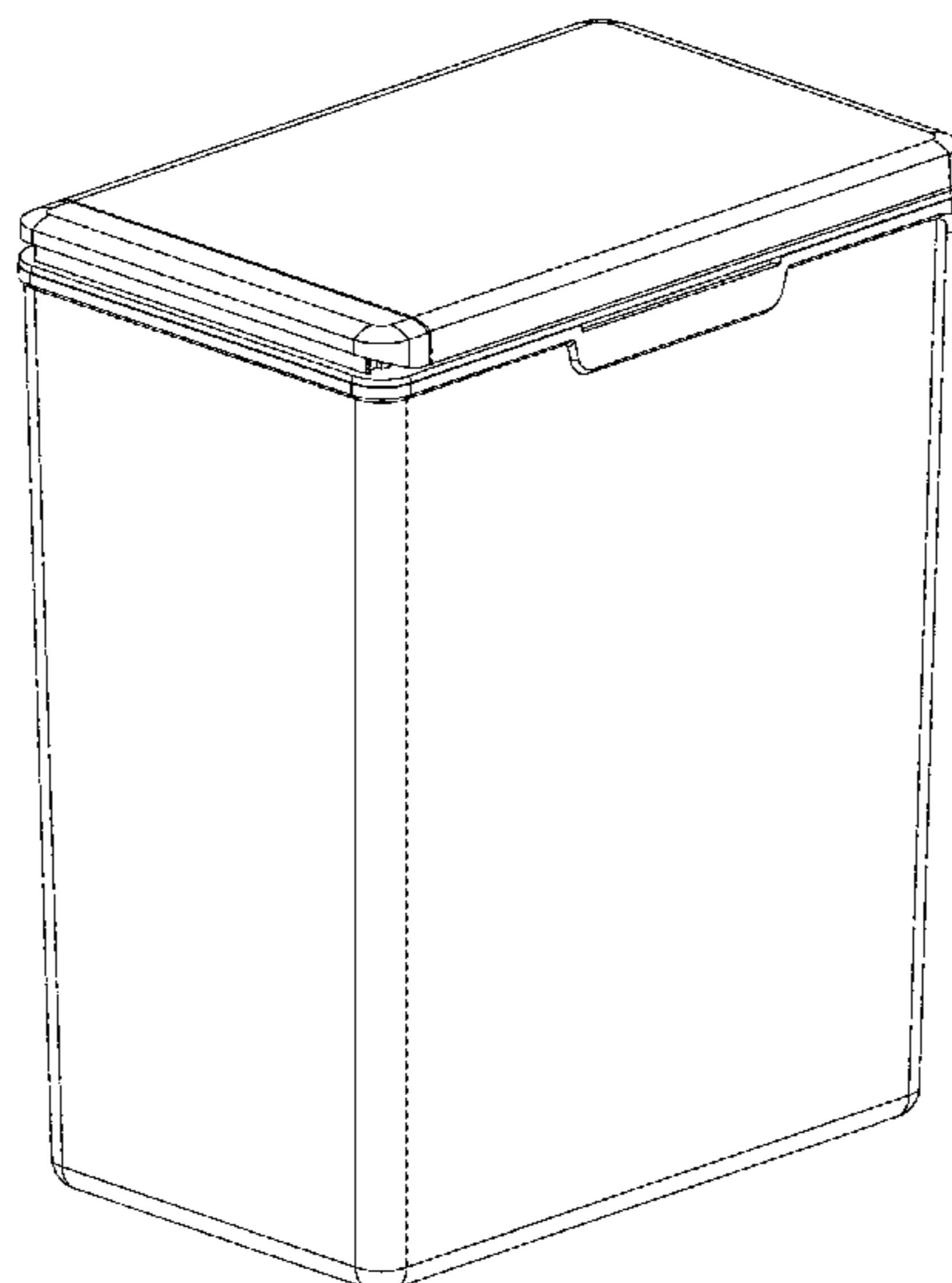

(56)

References Cited

U.S. PATENT DOCUMENTS

D533,703 S 12/2006 Lin
 D535,800 S 1/2007 Yang et al.
 D537,223 S 2/2007 Lin
 D537,599 S 2/2007 Lin
 D537,601 S 2/2007 Lin
 D538,000 S 3/2007 Lin
 D540,501 S 4/2007 Wang
 D542,001 S 5/2007 Yang et al.
 D543,673 S 5/2007 Yang et al.
 D544,671 S 6/2007 Saunders et al.
 D547,917 S 7/2007 Yang et al.
 D552,321 S 10/2007 Yang et al.
 D555,318 S 11/2007 Lin
 D555,320 S 11/2007 Yang et al.
 D561,969 S 2/2008 Lin
 D561,971 S 2/2008 Lin
 D566,367 S 4/2008 Lin
 D566,923 S 4/2008 Lin
 D567,468 S 4/2008 Yang et al.
 D568,570 S 5/2008 Lin
 D568,571 S 5/2008 Lin
 D571,520 S 6/2008 Lin
 D572,423 S 7/2008 Lin
 D580,120 S 11/2008 Lin
 D580,613 S 11/2008 Yang et al.
 D580,615 S 11/2008 Yang et al.
 D584,469 S 1/2009 Yang et al.
 D591,471 S 4/2009 Lee
 D593,271 S 5/2009 Yang et al.
 D593,796 S 6/2009 Kevan
 D595,917 S 7/2009 Liao
 7,559,433 B2 7/2009 Yang et al.
 7,597,210 B2 10/2009 Lin
 D620,667 S 7/2010 Liao
 D620,668 S 7/2010 Liao
 D627,533 S 11/2010 Yang et al.
 D629,579 S 12/2010 Lin
 D631,221 S 1/2011 Yang et al.
 D632,864 S 2/2011 Yang et al.
 D634,911 S 3/2011 Yang et al.
 D639,009 S 5/2011 Lin
 D644,390 S 8/2011 Smeets et al.
 D644,806 S 9/2011 Yang et al.
 8,074,824 B1 12/2011 Roby-Wilson
 8,074,833 B2 12/2011 Yang et al.
 D655,061 S 2/2012 Scaturro
 D657,108 S 4/2012 Yang et al.
 D657,109 S 4/2012 Liao
 D671,290 S 11/2012 Vanhoof
 D675,802 S 2/2013 Yang et al.
 D675,803 S 2/2013 Yang et al.
 D685,231 S 7/2013 Lane
 D709,662 S 7/2014 Yang et al.
 8,820,566 B2 9/2014 Ude
 D716,015 S 10/2014 van de Leest
 D717,014 S 11/2014 Han
 D719,313 S 12/2014 Kao
 D720,513 S 12/2014 Yang et al.
 D725,861 S 3/2015 Yang et al.
 D727,583 S 4/2015 Yang et al.
 D730,007 S 5/2015 Machen
 D730,008 S 5/2015 Yang et al.
 D734,912 S 7/2015 Ho et al.
 D739,109 S 9/2015 Becham et al.
 D736,489 S 10/2015 Wall
 D743,138 S 11/2015 Sun Ting Kung et al.
 D754,413 S 4/2016 Wall
 D759,934 S 6/2016 Yang et al.
 D762,037 S 7/2016 Chen
 D765,937 S 9/2016 Chen
 D769,564 S 10/2016 Chen
 D771,344 S 11/2016 Yang et al.
 D773,145 S 11/2016 Yang et al.
 D773,769 S 12/2016 Chen
 D787,828 S 5/2017 Thoma et al.

D790,145 S 6/2017 Chen
 D793,022 S 7/2017 Liao
 D793,642 S 8/2017 Yang et al.
 D796,766 S 9/2017 Chen
 D796,767 S 9/2017 Chen
 D798,016 S 9/2017 Yang et al.
 D803,505 S 11/2017 Duvigneau
 D804,133 S 11/2017 Yang et al.
 D809,729 S 2/2018 Chen
 D813,485 S 3/2018 Liao
 D825,130 S 8/2018 Duvigneau
 D827,968 S 9/2018 Chen
 D829,400 S 9/2018 Yang et al.
 D830,029 S 10/2018 Greenspon et al.
 D830,659 S 10/2018 Greenspon et al.
 D831,289 S 10/2018 Greenspon et al.
 D835,374 S 12/2018 Yang et al.
 D836,278 S 12/2018 Berberet et al.
 D837,473 S 1/2019 Magnuson et al.
 D841,275 S 2/2019 Chen
 D842,573 S 3/2019 Smeets
 D845,576 S 4/2019 Lu
 D851,349 S 6/2019 Beumer et al.
 D851,350 S 6/2019 Lu
 D853,064 S 7/2019 Chen
 D853,066 S 7/2019 Liao
 D853,067 S 7/2019 Chen
 D853,068 S 7/2019 Chen
 D855,919 S 8/2019 Yang et al.
 D860,570 S 9/2019 Chen
 D871,012 S 12/2019 Chen
 D871,707 S * 12/2019 Chen B65F 1/08
 D34/7
 D872,959 S * 1/2020 Chen D34/7
 D872,960 S * 1/2020 Chen D34/7
 D878,854 S 3/2020 Lee
 D879,400 S 3/2020 Chen
 D886,402 S * 6/2020 Chen D34/9
 D895,918 S 9/2020 Stravitz
 D903,217 S * 11/2020 Smeets D34/7
 D906,620 S * 12/2020 Tan B65F 1/1638
 D34/8
 D915,713 S * 4/2021 Chen B65F 1/1638
 D34/9
 D942,106 S * 1/2022 Liao D34/9
 2003/0201267 A1 10/2003 Yang et al.
 2005/0006536 A1 1/2005 Yang et al.
 2005/0082196 A1 4/2005 Lin
 2005/0230397 A1 10/2005 Yang et al.
 2006/0278643 A1 12/2006 Chiou
 2007/0090112 A1 4/2007 Kalman et al.
 2007/0205195 A1 9/2007 Yang et al.
 2008/0006638 A1 1/2008 Yang et al.
 2008/0116207 A1 5/2008 Yang et al.
 2009/0314779 A1 12/2009 Lee
 2010/0147865 A1 6/2010 Yang et al.
 2011/0017735 A1 1/2011 Wang et al.
 2011/0049149 A1 3/2011 Shih
 2011/0139781 A1 6/2011 Jin et al.
 2011/0220648 A1 * 9/2011 Yang B65F 1/1638
 220/211
 2013/0098913 A1 4/2013 Yang et al.
 2013/0105486 A1 5/2013 Mashburn et al.
 2013/0213965 A1 * 8/2013 Shek B65F 1/1638
 220/211
 2013/0233853 A1 * 9/2013 Yang B65F 1/02
 220/211
 2014/0238989 A1 8/2014 Wang et al.
 2014/0305946 A1 10/2014 Han
 2019/0152696 A1 * 5/2019 Wegner B65F 1/08

OTHER PUBLICATIONS

The Home Depot.com Feb. 8, 2022, CozyBlock 13 Gal. Automatic Trash Can for Kitchen, <https://www.homedepot.com/p/eModernDecor-CozyBlock-13-Gal-Automatic-Trash-Can-for-Kitchen-Black-Steel-Touchless-Operation-Motion-Sensor-Bin-HN-ZS02-13-BLK/317492097> (Year: 2022).*

(56)

References Cited

OTHER PUBLICATIONS

At home.com Feb. 8, 2022, 68 L Square Sensor Bin Stainless Steel, <https://www.athome.com/68l-square-sensor-bin-stainless-steel/124319758.html> (Year: 2022).*

Walmart.com Feb. 8, 2022, Better Homes & Garden 13.7 gal touchless dual sensor garbage can, <https://www.walmart.com/ip/Better-Homes-Gardens-13-7-gal-Touchless-Dual-Sensor-Kitchen-Garbage-Can-with-Stay-Open-Lid-Black/968281256> (Year: 2022).*

Eko Step on Trash Can, announced 2020 [online], [site visited Sep. 17, 2020]. Available from internet, URL: <https://www.ekousa.com/shop-all/serene-round-step-can/> (Year: 2020).

Simple Human, announced Dec. 23, 2015 [online], [site visited Sep. 17, 2020]. Available from internet, URL: <https://www.simplehuman.com/products/round-classic-step-can-301> (Year: 2015).

Amazon Honey Can Do, announced 2015 [online], [site visited Sep. 17, 2020]. Available from internet, URL: https://www.amazon.com/Honey-Can-Do-TRS-02110-Stainless-30-Liter-8-Gallon/dp/B007ZSLRD4/ref=sr_1_3 (Year: 2015).

Target, announced 2020 [online], [site visited Sep. 17, 2020]. Available from internet, URL: <https://www.target.com/p/301-step-trash-can-silver-made-by-design-8482/-/A-78261306> (Year: 2020).

Eko Artistic Step on Trash Can, announced 2020 [online], [site visited Sep. 17, 2020]. Available from internet, URL: <https://www.ekousa.com/shop-all/serene-round-step-can/> (Year: 2020).

Eko Ava Step on Trash Can, announced 2020 [online], [site visited Sep. 17, 2020]. Available from internet, URL: <https://www.ekousa.com/shop-all/serene-round-step-can/> (Year: 2020).

Belson Outdoors “Durable Two-Piece Fiberglass Trash Receptacle”, <http://www.belson.com/Open-Top-Lift-Off-20-Gallon-Round-Fiberglass-Trash-Can>. Jun. 6, 2017. shown in p. 1, Model FG1829 TPL.

Amazon “Simplehuman Bullet Open Trash Can”, https://www.amazon.com/simplehuman-Bullet-Trash-Commercial-Stainless/dp/B000BHUHP0/ref=cm_cr_ar_p_d_product_top?ie=UTF8. Apr. 17, 2008. shown in p. 1, Model No. CW1407.

Amazon: “Trash bin sensor”, <https://www.amazon.com/trash-bin-sensor/s?k=trash+bin+sensor>.

* cited by examiner

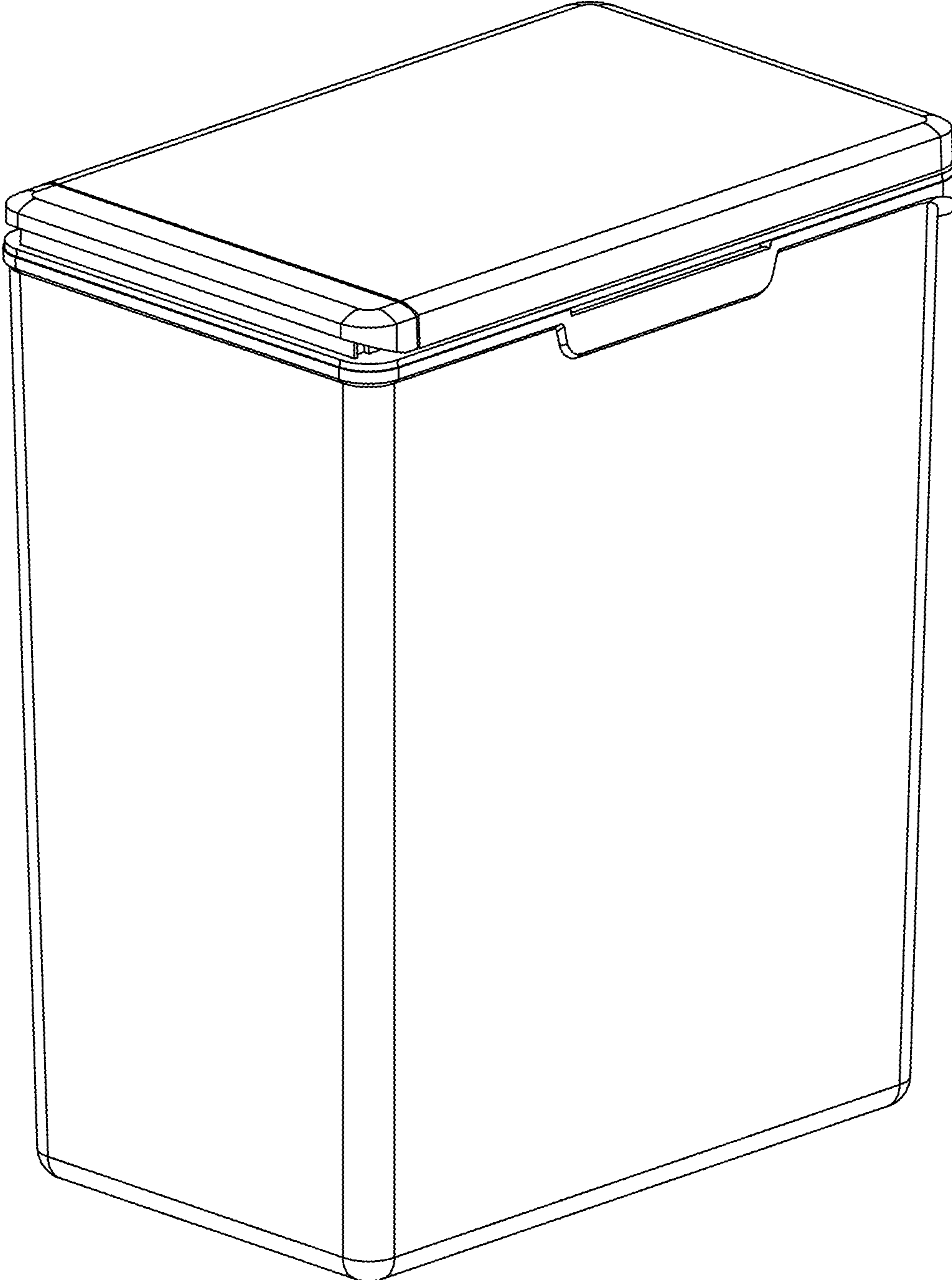

FIG. 1

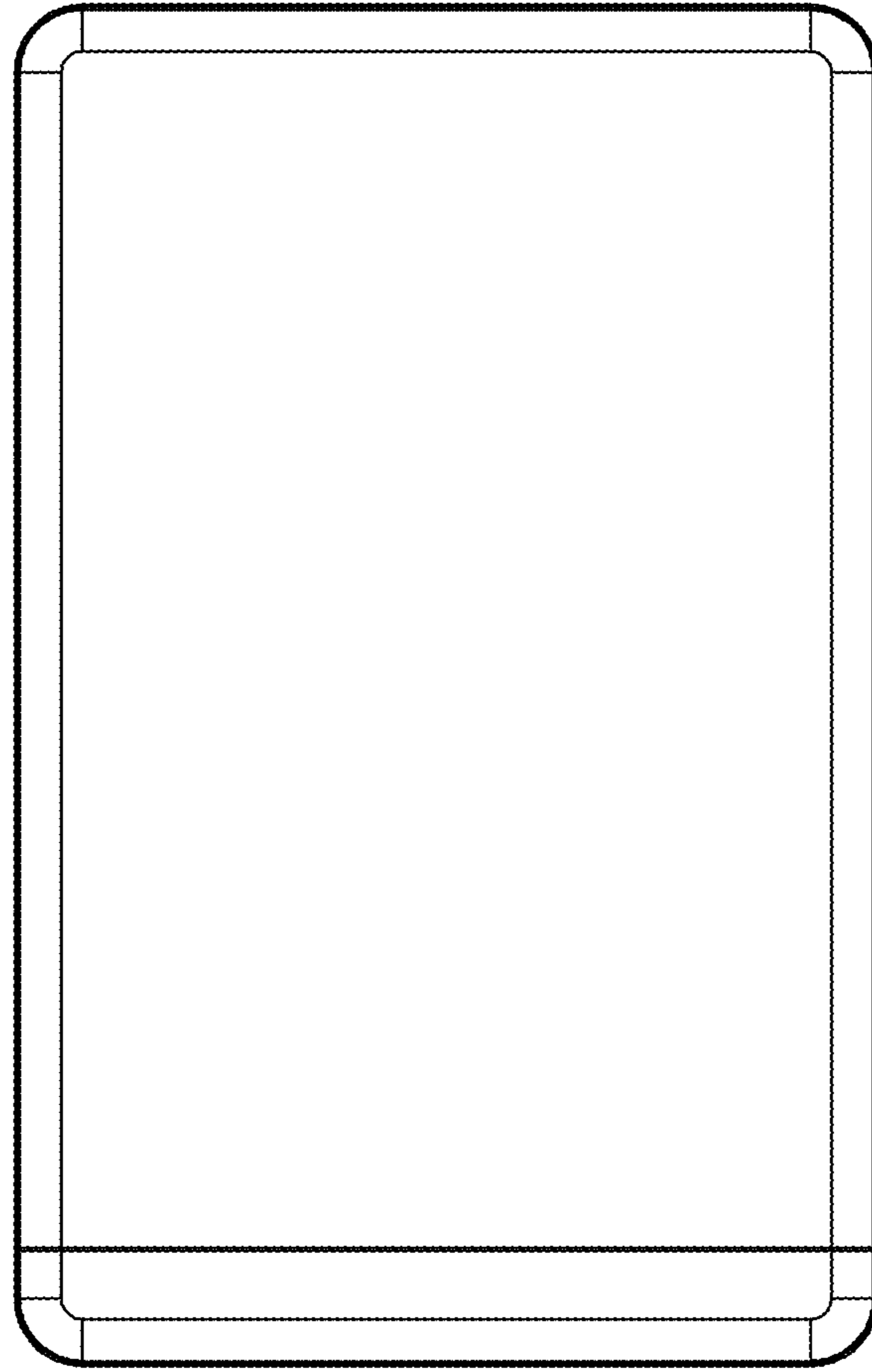

FIG. 2

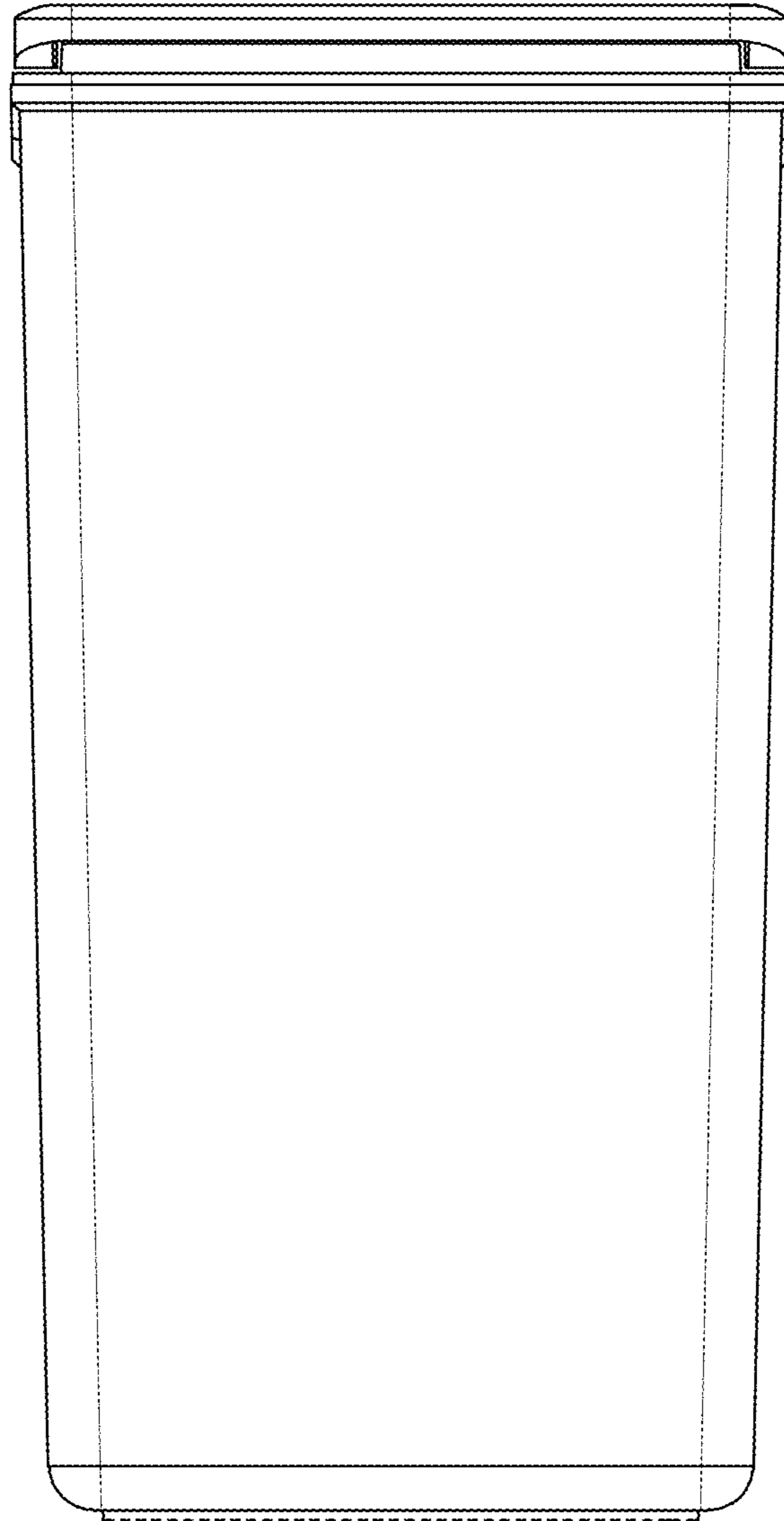

FIG. 3

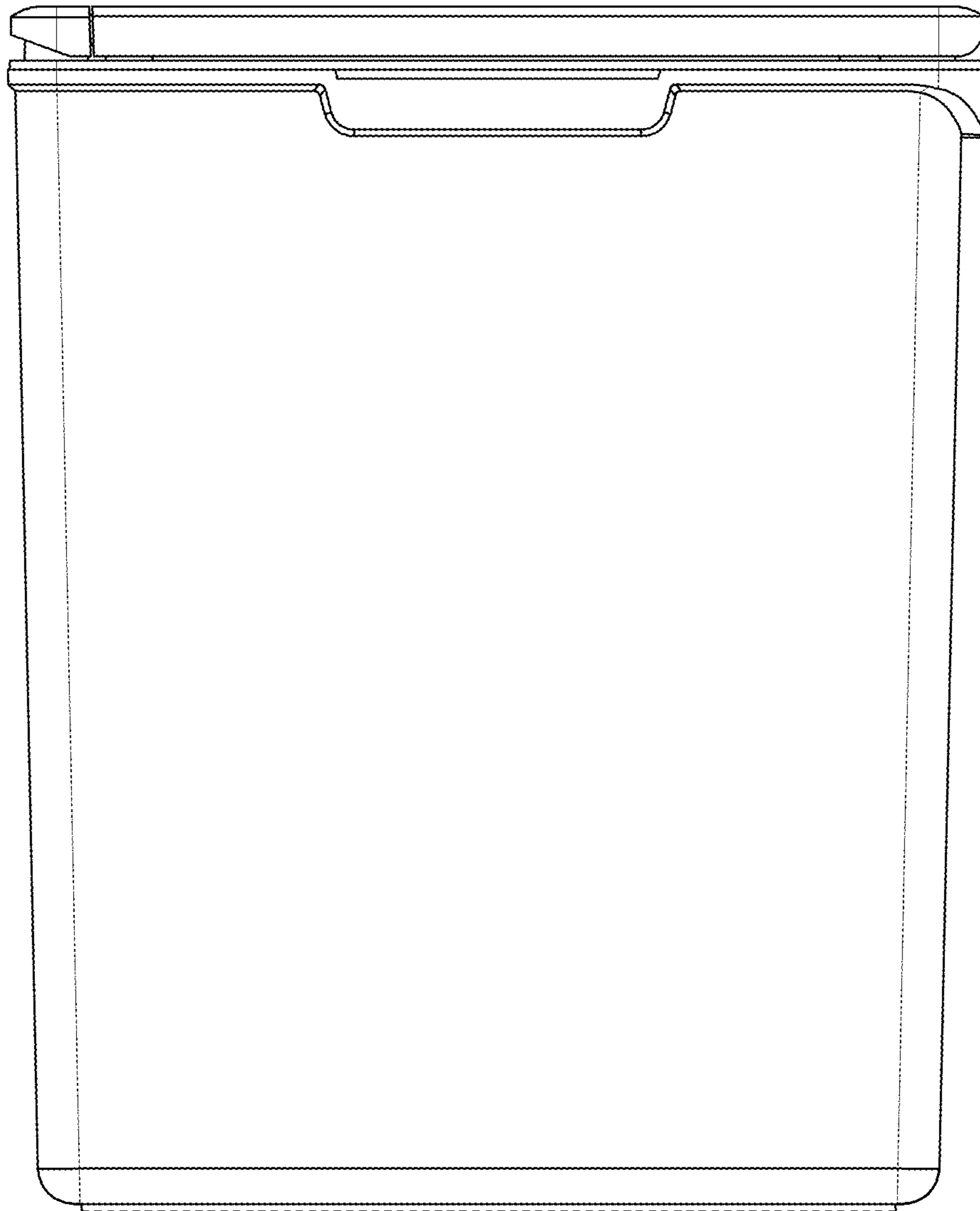

FIG. 4

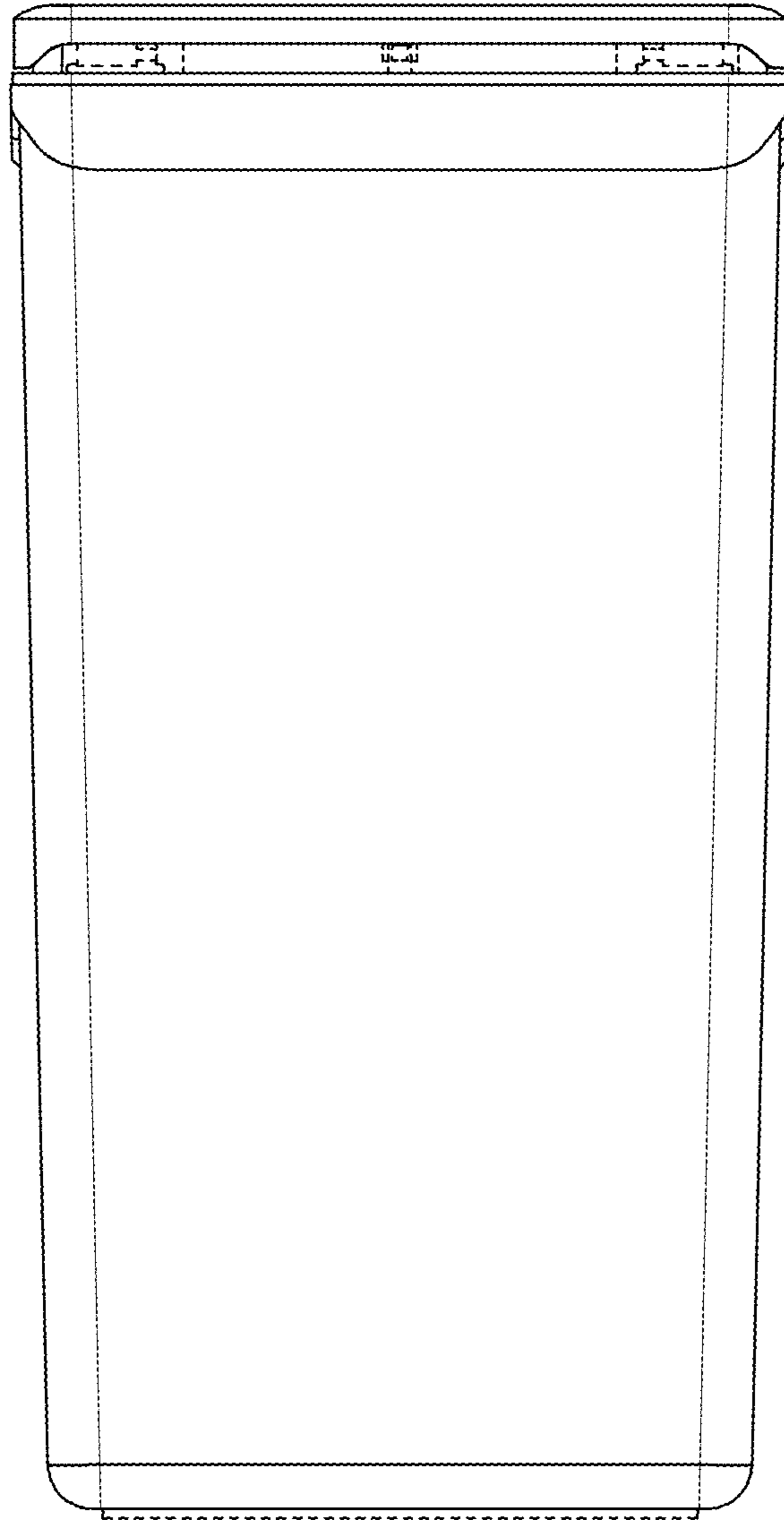

FIG. 5

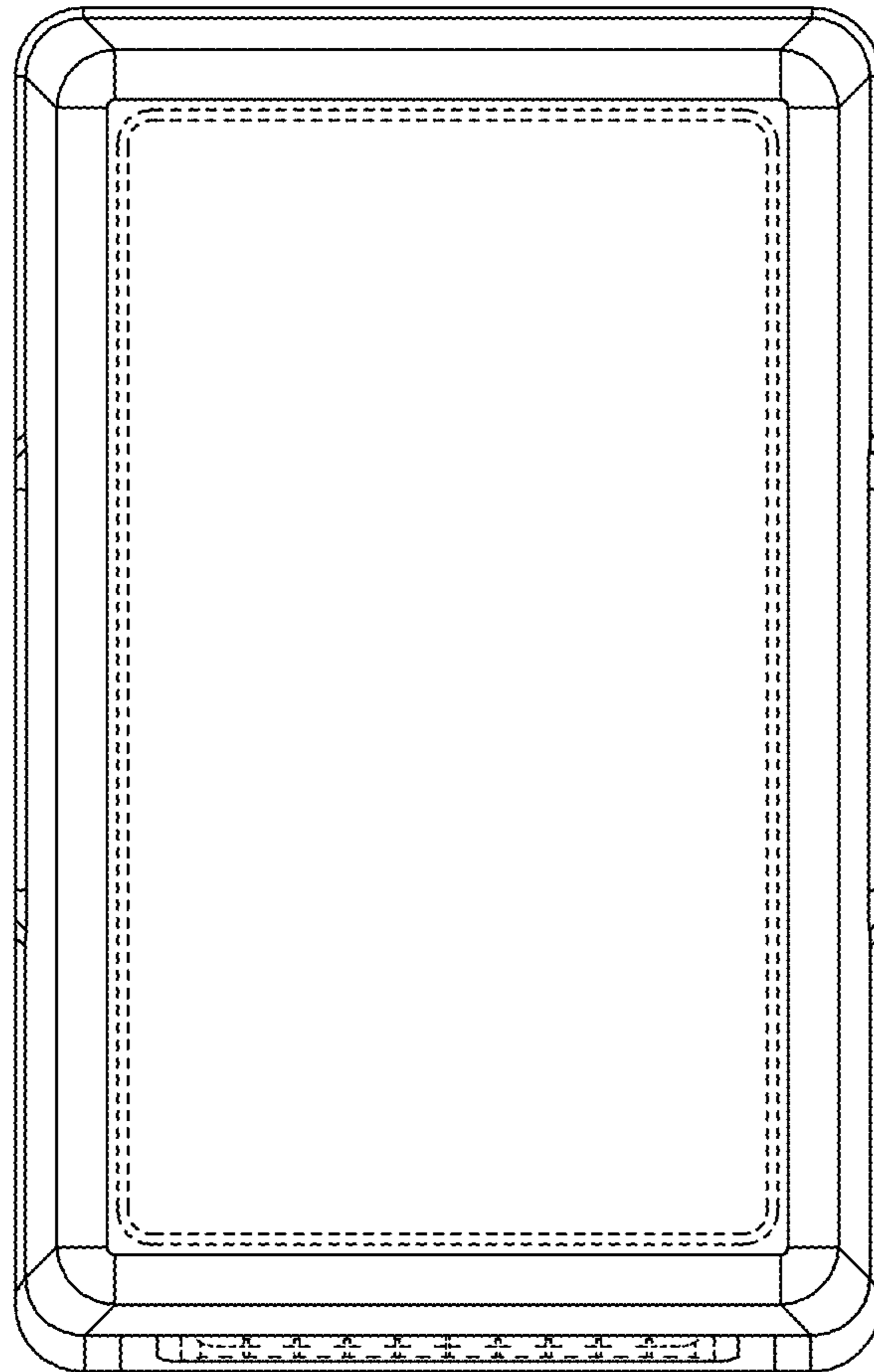

FIG. 6

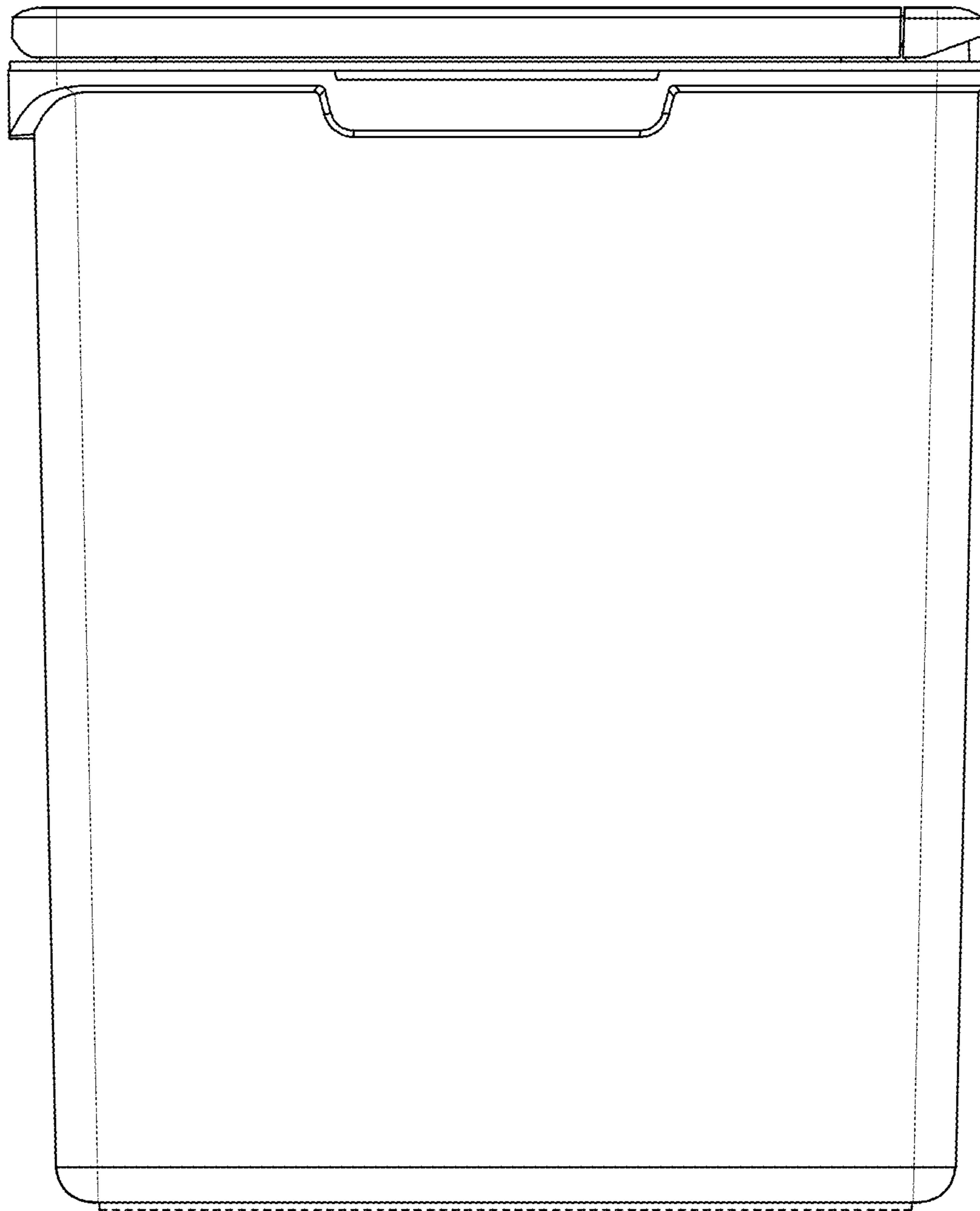

FIG. 7