



US00D955621S

(12) **United States Design Patent**
Genovese

(10) **Patent No.:** **US D955,621 S**
(45) **Date of Patent:** **** Jun. 21, 2022**

(54) **WALL LIGHT SET**

(71) Applicant: **H - 07 SRL**, Milan (IT)

(72) Inventor: **Isabella Genovese**, Pieve di Soligo (IT)

(73) Assignee: **H - 07 SRL**, Milan (IT)

(**) Term: **15 Years**

(21) Appl. No.: **29/716,673**

(22) Filed: **Dec. 11, 2019**

(30) **Foreign Application Priority Data**

Sep. 9, 2019 (EM) 006849634-0001

Sep. 9, 2019 (EM) 006849634-0002

(Continued)

(51) **LOC (13) Cl.** **26-05**

(52) **U.S. Cl.**
USPC **D26/80**

(58) **Field of Classification Search**
USPC D26/24, 71, 72, 76, 78, 80-87, 90, 92,
D26/113, 118, 120, 138, 145, 155
(Continued)

(56) **References Cited**

U.S. PATENT DOCUMENTS

5,181,777 A * 1/1993 Segill F21S 8/065

362/405

D564,125 S * 3/2008 Chandler D26/85

(Continued)

OTHER PUBLICATIONS

Gallery_of_empty_frames_on_wall_with_lighting (available online)
Retrieved from the internet Apr. 29, 2022 from URL: <https://www.vectorstock.com/royalty-free-vector/gallery-of-empty-frames-on-wall-with-lighting-vector-11715886>.*

(Continued)

Primary Examiner — Richard Kearney

(74) *Attorney, Agent, or Firm* — Richard M. Goldberg

(57) **CLAIM**

The ornamental design for a wall light set, as shown and described.

DESCRIPTION

FIG. 1 is a front perspective view of a first portion of the wall light set shown separately for completeness of illustration; FIG. 2 is a front perspective view thereof from a different angle;

FIG. 3 is a rear perspective view thereof;

FIG. 4 is a front elevational view thereof;

FIG. 5 is a rear elevational view thereof;

FIG. 6 is a left side elevational view thereof;

FIG. 7 is a right side elevational view thereof;

FIG. 8 is a top plan view thereof;

FIG. 9 is a bottom plan view thereof;

FIG. 10 is a front perspective view of a second portion of the wall light set shown separately for completeness of illustration;

FIG. 11 is a front perspective view of the wall light set of FIG. 10 from a different angle;

FIG. 12 is a rear perspective view of the wall light set of FIG. 10;

FIG. 13 is a front elevational view of the wall light set of FIG. 10;

FIG. 14 is a rear elevational view of the wall light set of FIG. 10;

FIG. 15 is a left side elevational view of the wall light set of FIG. 10;

FIG. 16 is a right side elevational view of the wall light set of FIG. 10;

FIG. 17 is a top plan view of the wall light set of FIG. 10;

FIG. 18 is a bottom plan view of the wall light set of FIG. 10;

FIG. 19 is a front perspective view of a thirds portion of the wall light set shown separately for completeness of illustration;

FIG. 20 is a front perspective view of the wall light set of FIG. 19 from a different angle;

(Continued)

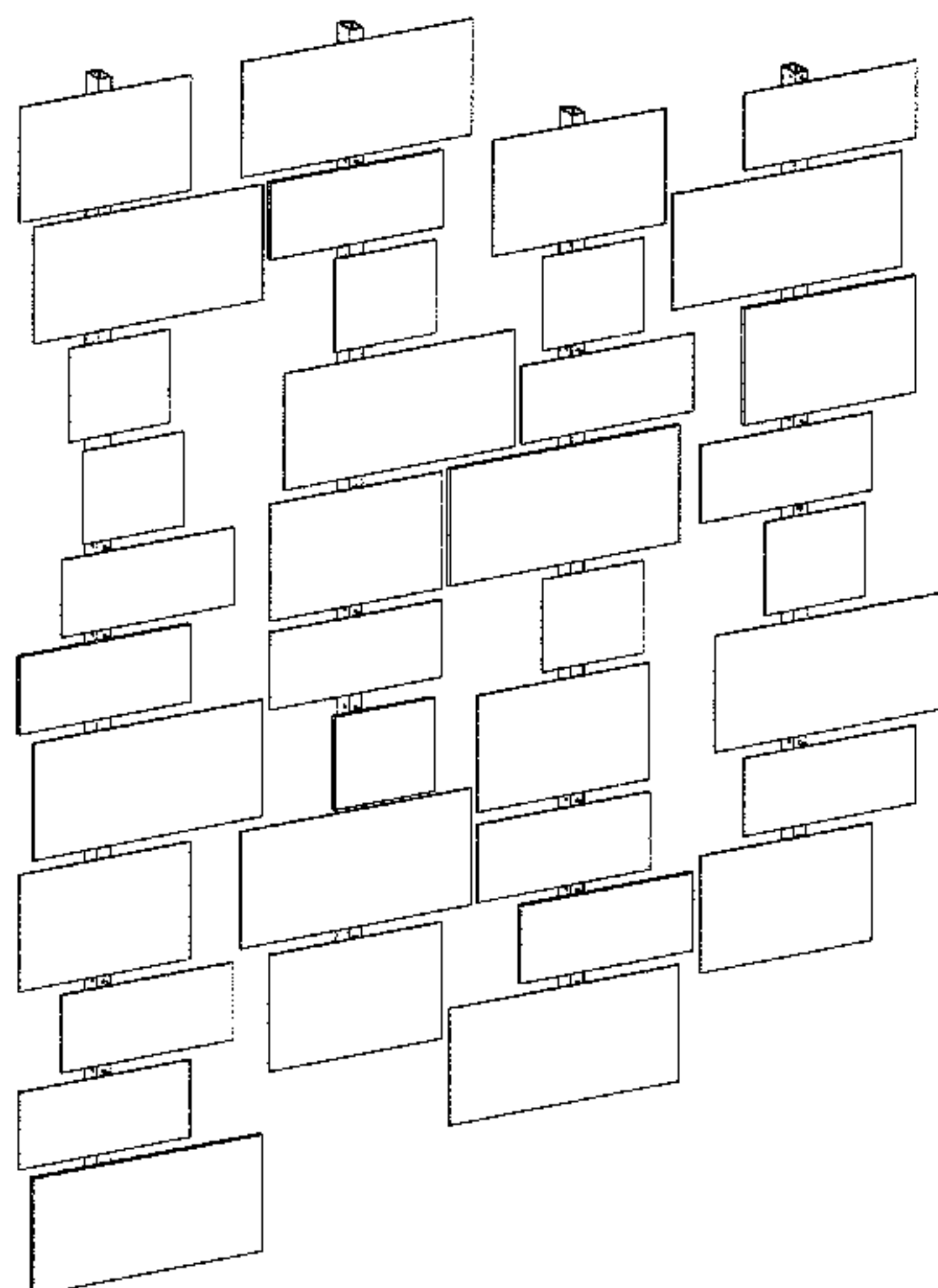

FIG. 21 is a rear perspective view of the wall light set of FIG. 19;
 FIG. 22 is a front elevational view of the wall light set of FIG. 19;
 FIG. 23 is a rear elevational view of the wall light set of FIG. 19;
 FIG. 24 is a left side elevational view of the wall light set of FIG. 19;
 FIG. 25 is a right side elevational view of the wall light set of FIG. 19;
 FIG. 26 is a top plan view of the wall light set of FIG. 19;
 FIG. 27 is a bottom plan view of the wall light set of FIG. 19;
 FIG. 28 is a front perspective view of a fourth portion of the wall light set shown separately for completeness of illustration;
 FIG. 29 is a front perspective view of the wall light set of FIG. 28 from a different angle;
 FIG. 30 is a rear perspective view of the wall light set of FIG. 28;
 FIG. 31 is a front elevational view of the wall light set of FIG. 28;
 FIG. 32 is a rear elevational view of the wall light set of FIG. 28;
 FIG. 33 is a left side elevational view of the wall light set of FIG. 28;
 FIG. 34 is a right side elevational view of the wall light set of FIG. 28;
 FIG. 35 is a top plan view of the wall light set of FIG. 28;
 FIG. 36 is a bottom plan view of the wall light set of FIG. 28;
 FIG. 37 is a front perspective view of the complete wall light set including the first through fourth portions;
 FIG. 38 is a front perspective view of the wall light set of FIG. 37 from a different angle;
 FIG. 39 is a rear perspective view of the wall light set of FIG. 37;
 FIG. 40 is a front elevational view of the wall light set of FIG. 37;
 FIG. 41 is a rear elevational view of the wall light set of FIG. 37;
 FIG. 42 is a left side elevational view of the wall light set of FIG. 37;

FIG. 43 is a right side elevational view of the wall light set of FIG. 37;
 FIG. 44 is a top plan view of the wall light set of FIG. 37;
 and,
 FIG. 45 is a bottom plan view of the wall light set of FIG. 37.

1 Claim, 45 Drawing Sheets

(30) **Foreign Application Priority Data**

Sep. 9, 2019 (EM) 006849634-0003
 Sep. 9, 2019 (EM) 006849634-0004
 Sep. 9, 2019 (EM) 006849634-0005

(58) **Field of Classification Search**

CPC F21S 8/00; F21S 8/033; F21S 8/036; F21S 8/061; F21S 8/063; F21S 8/068; F21S 8/085; F21S 8/086; F21W 2131/103; F21W 2131/105; F21W 2131/107; G02B 6/24; G02B 6/0001

See application file for complete search history.

(56) **References Cited**

U.S. PATENT DOCUMENTS

D564,695 S * 3/2008 Krause D26/85
 D655,439 S * 3/2012 Sabernig D26/86
 D700,736 S * 3/2014 Schuyler D26/113
 D715,478 S * 10/2014 Blum D26/85
 D825,814 S * 8/2018 Sonneman D26/85
 2014/0049956 A1 * 2/2014 Manahan F21V 21/14
 362/249.02

OTHER PUBLICATIONS

Henge_19_Catalogue (available online Mar. 29, 2019) Retrieved from the internet Apr. 29, 2022 from URL: https://issuu.com/ashtongrove1/docs/h19_book_web.*

* cited by examiner

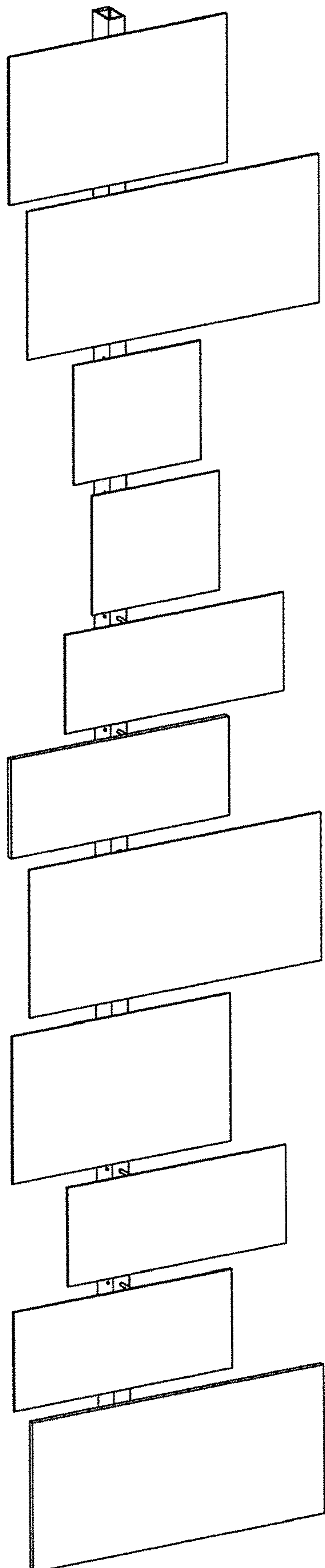

FIG. 1

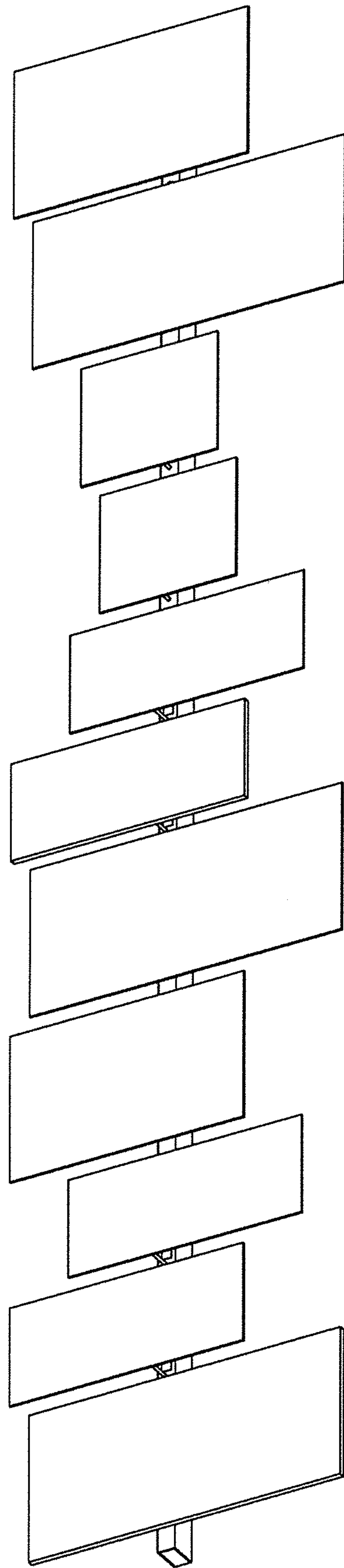

FIG. 2

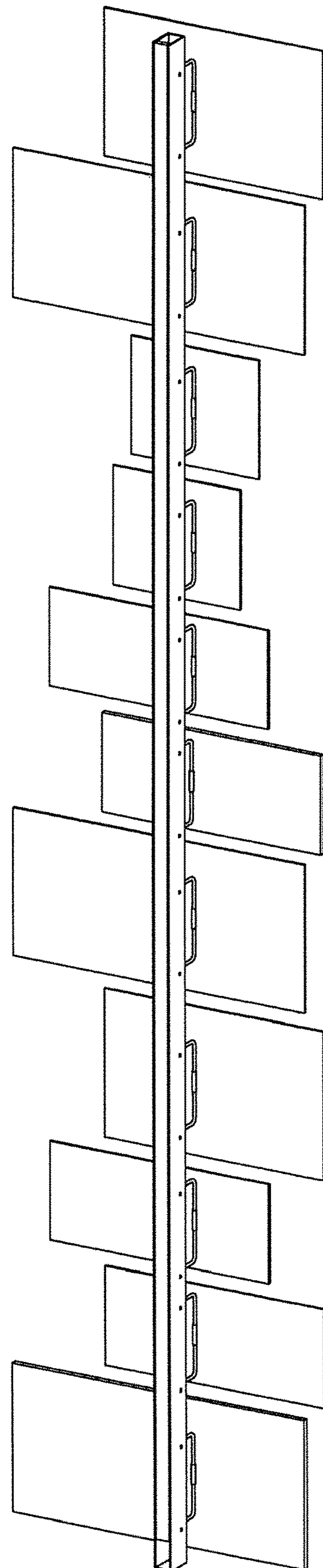

FIG. 3

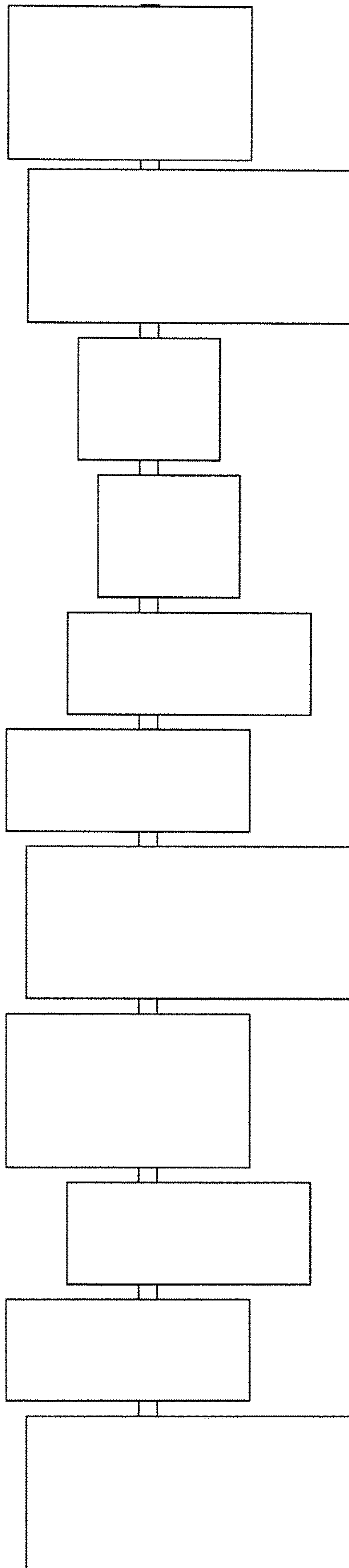

FIG. 4

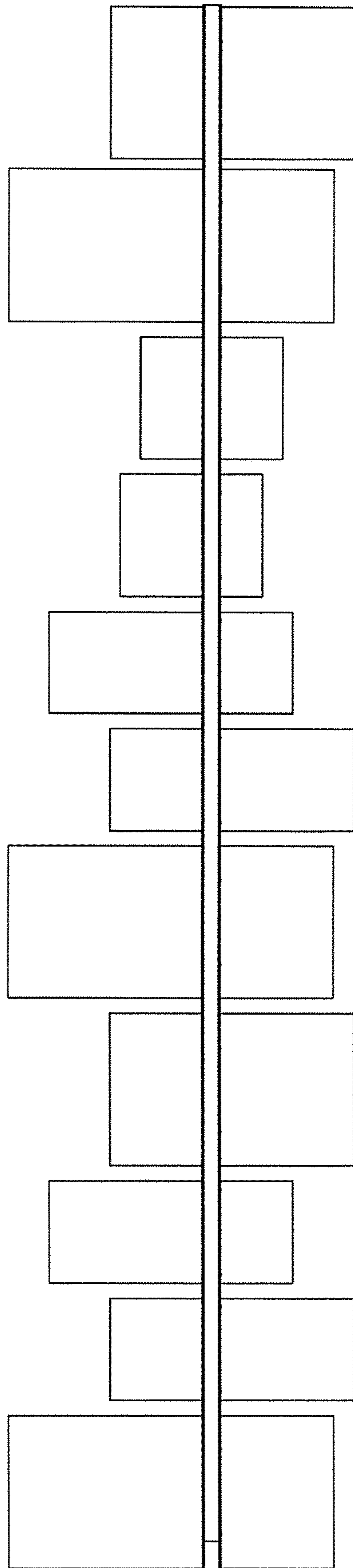

FIG. 5

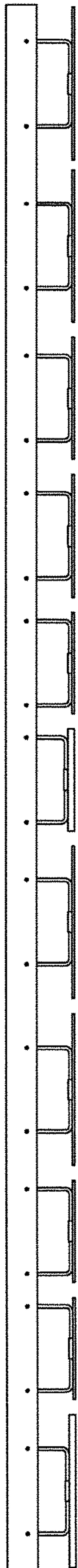

FIG. 6

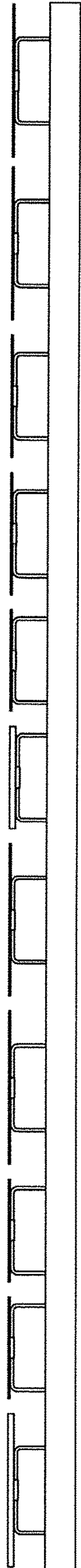

FIG. 7

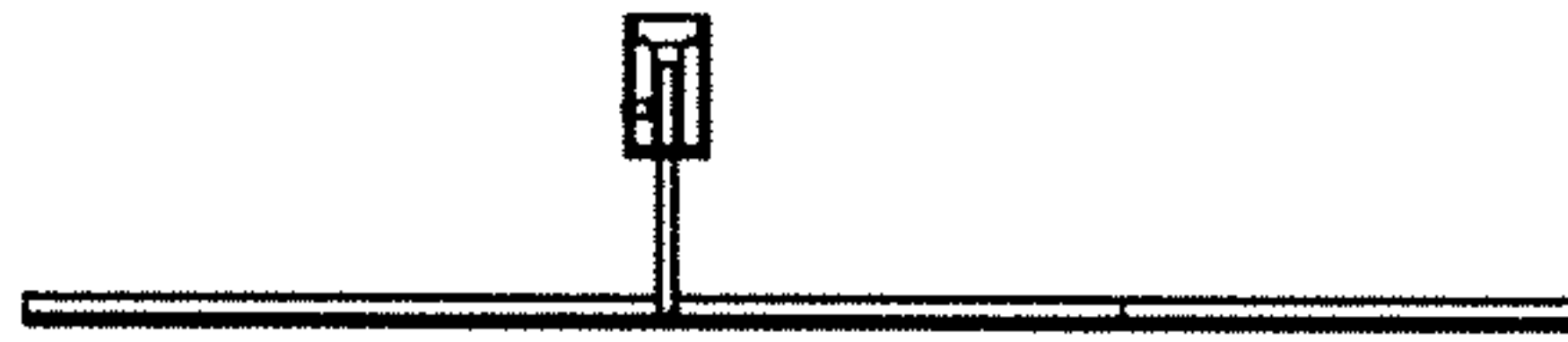

FIG. 8

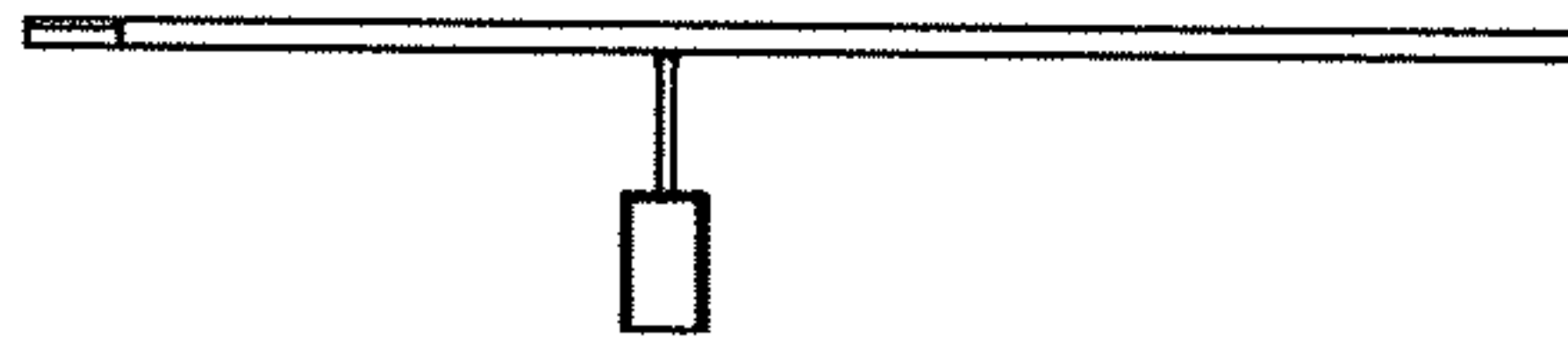

FIG. 9

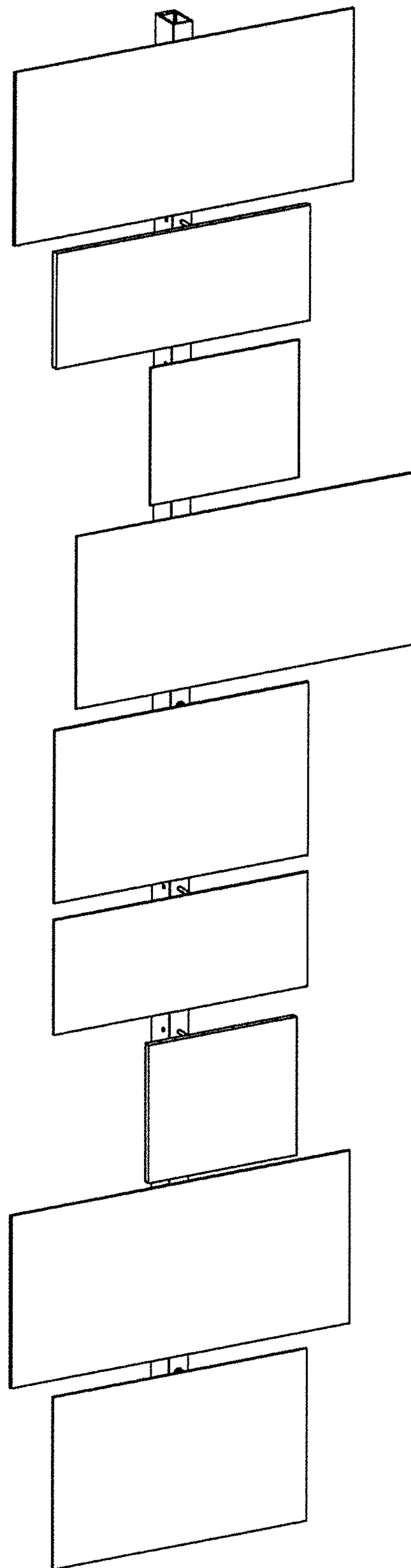

FIG. 10

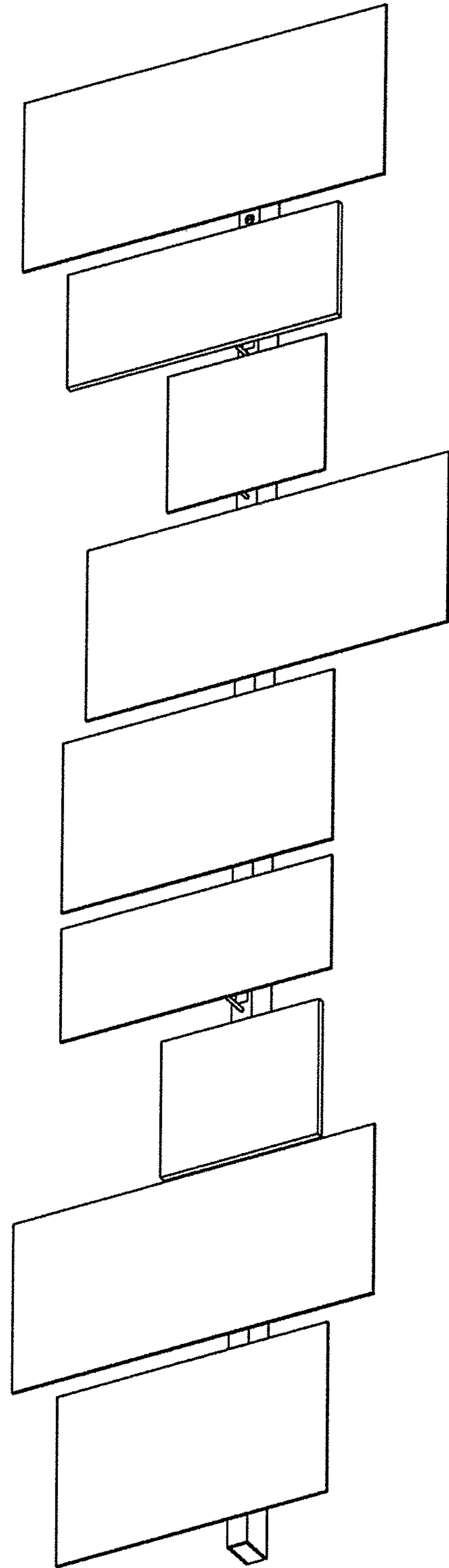

FIG. 11

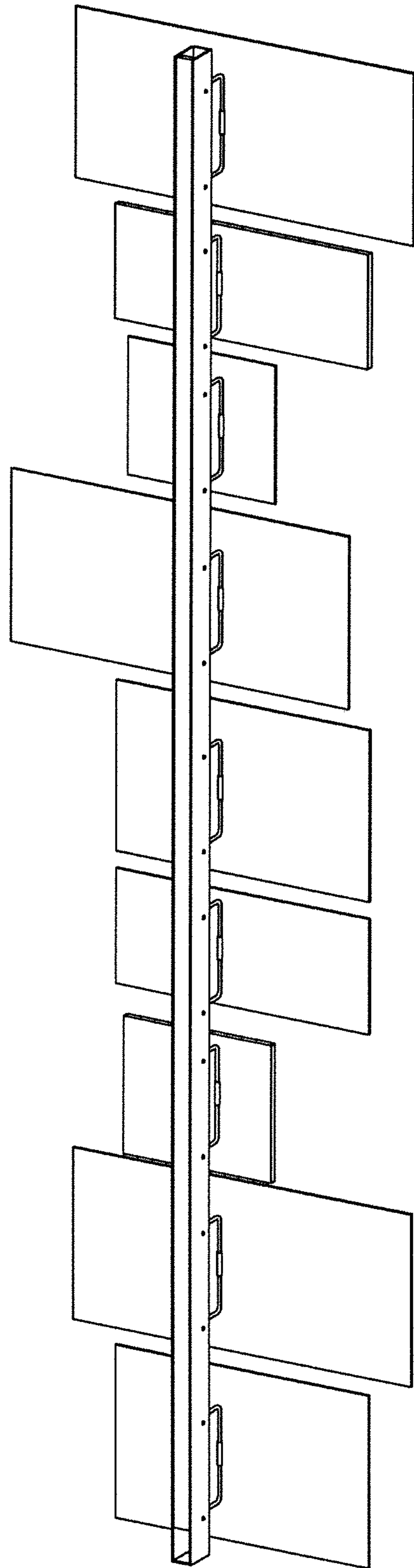

FIG. 12

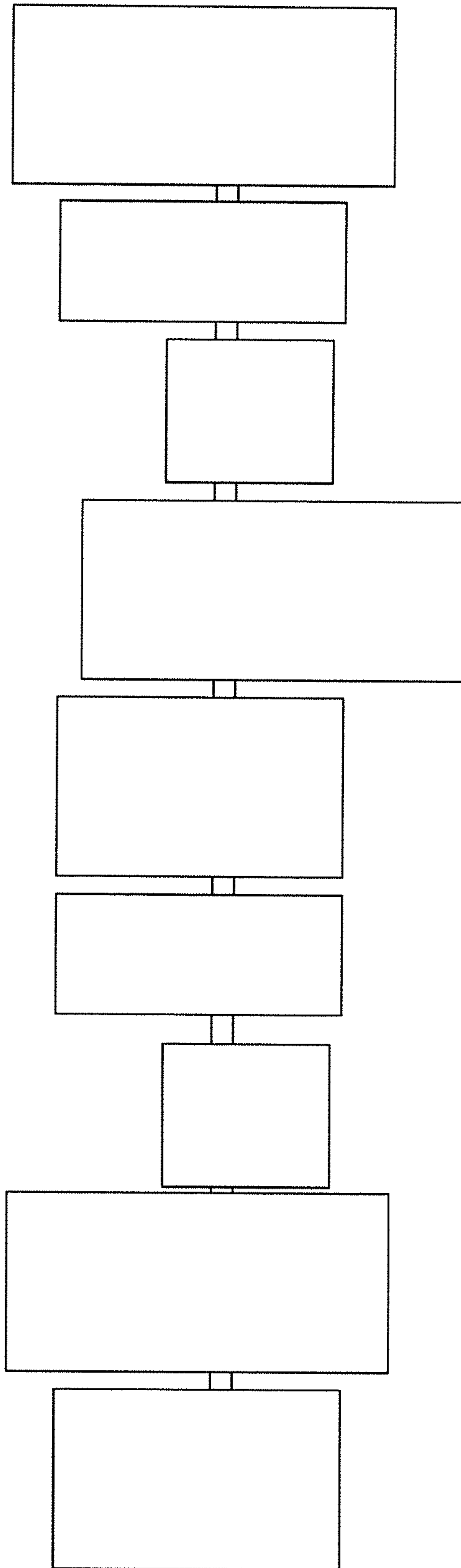

FIG. 13

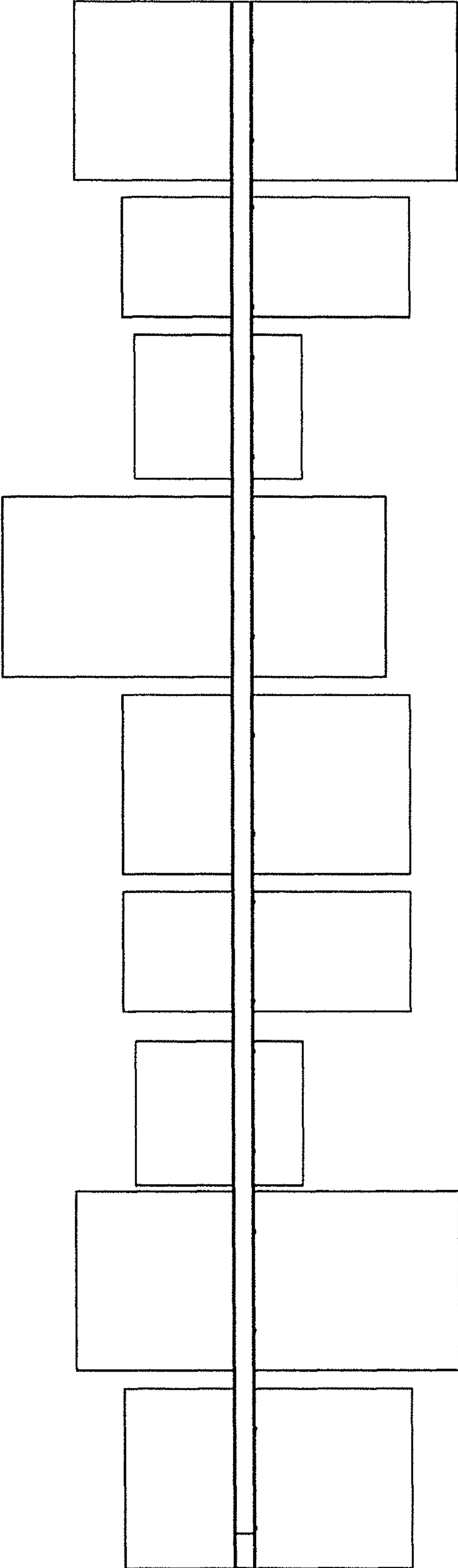

FIG. 14

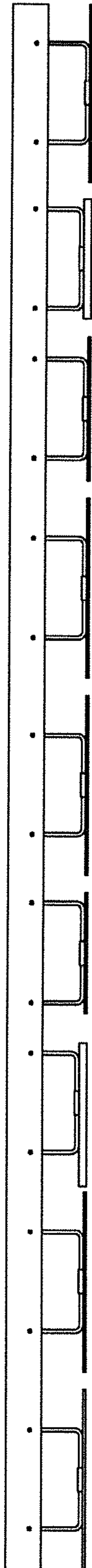

FIG. 15

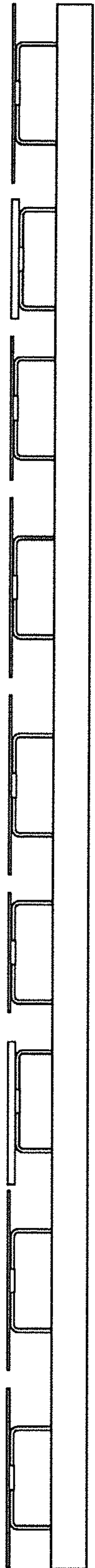

FIG. 16

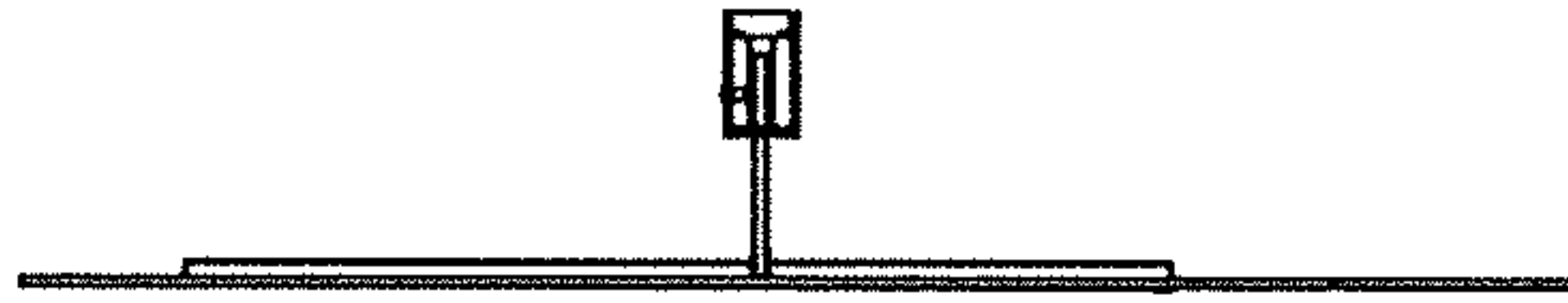

FIG. 17

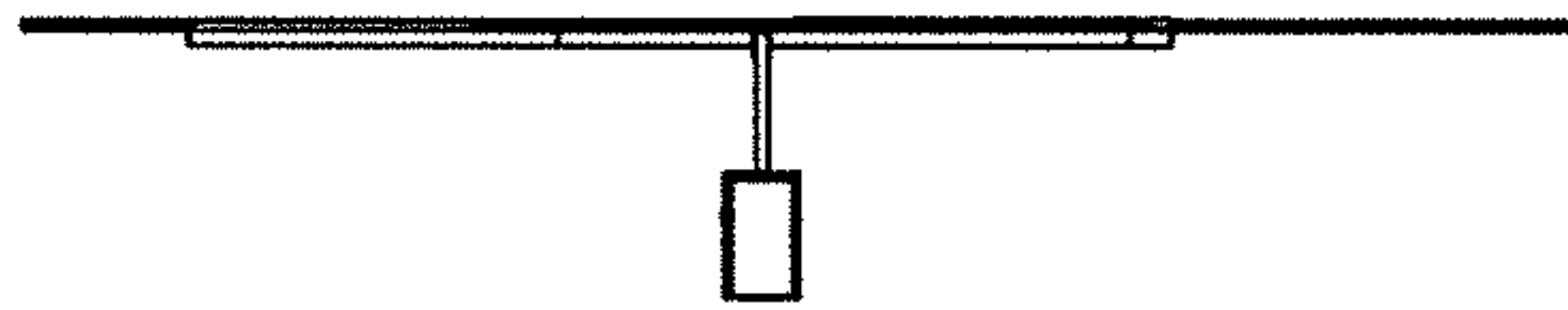

FIG. 18

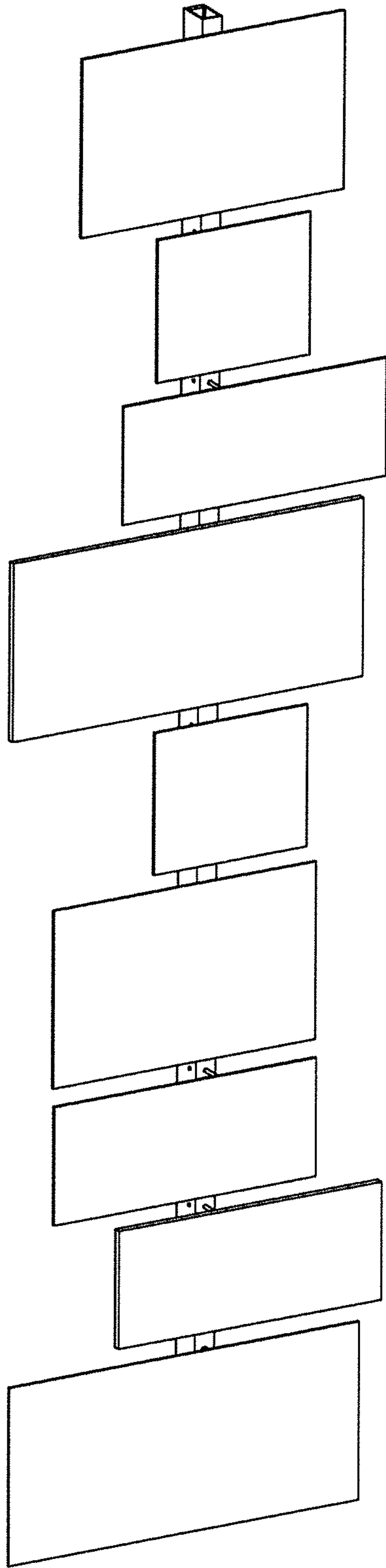

FIG. 19

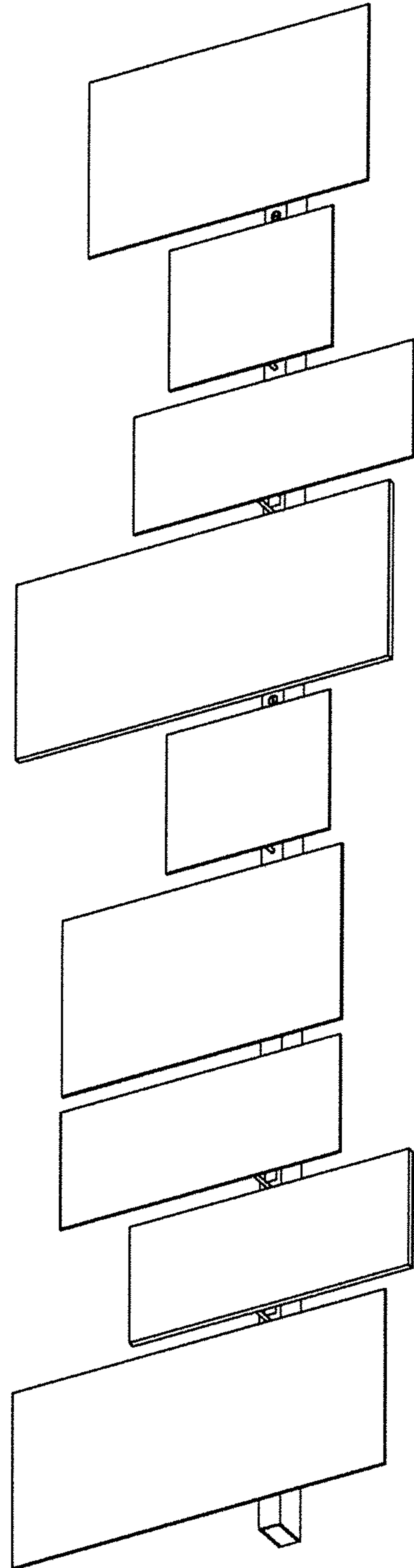

FIG. 20

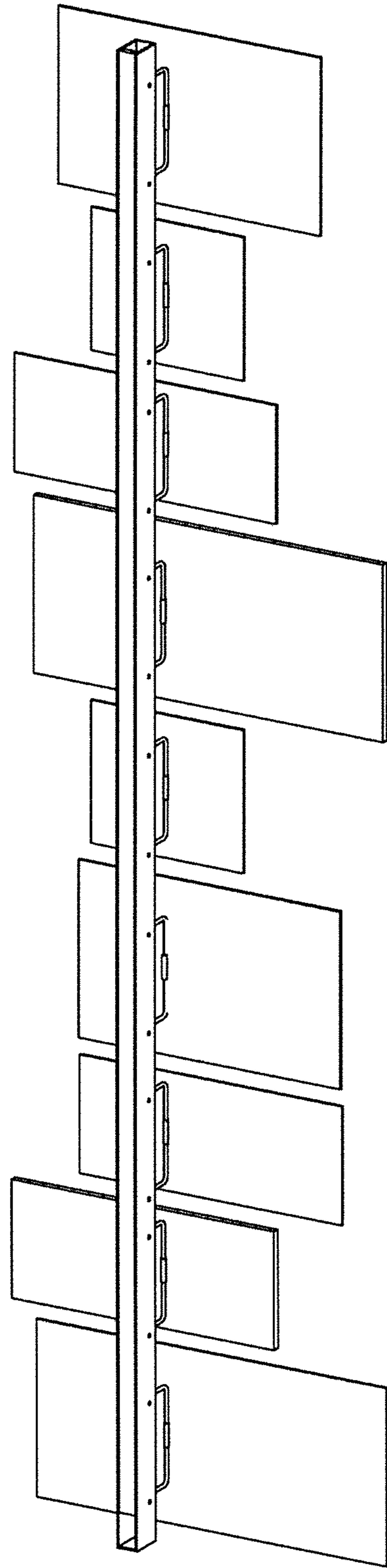

FIG. 21

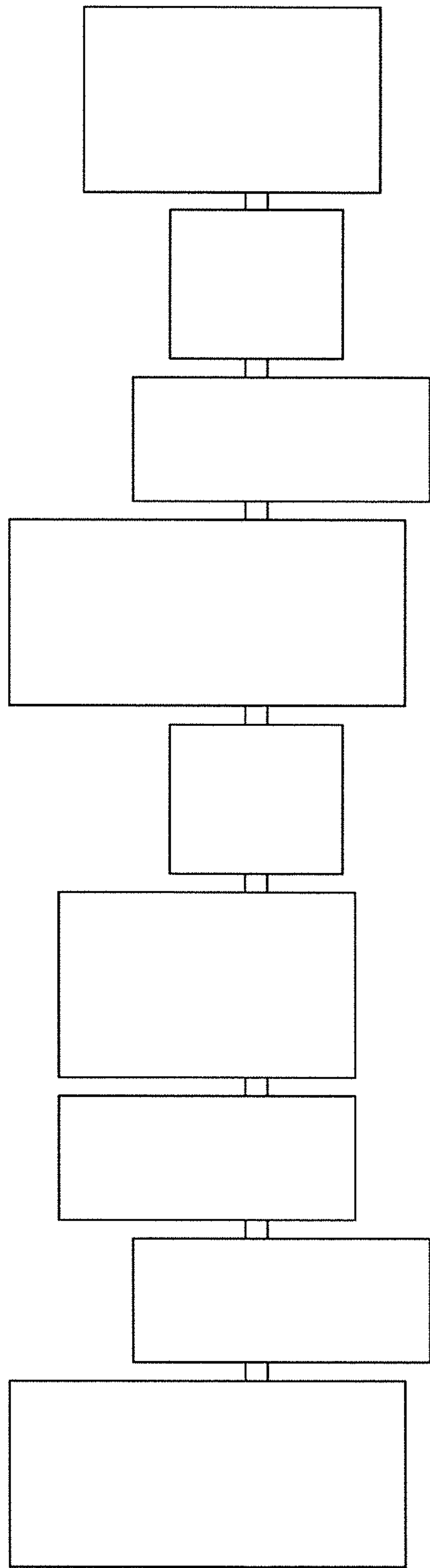

FIG. 22

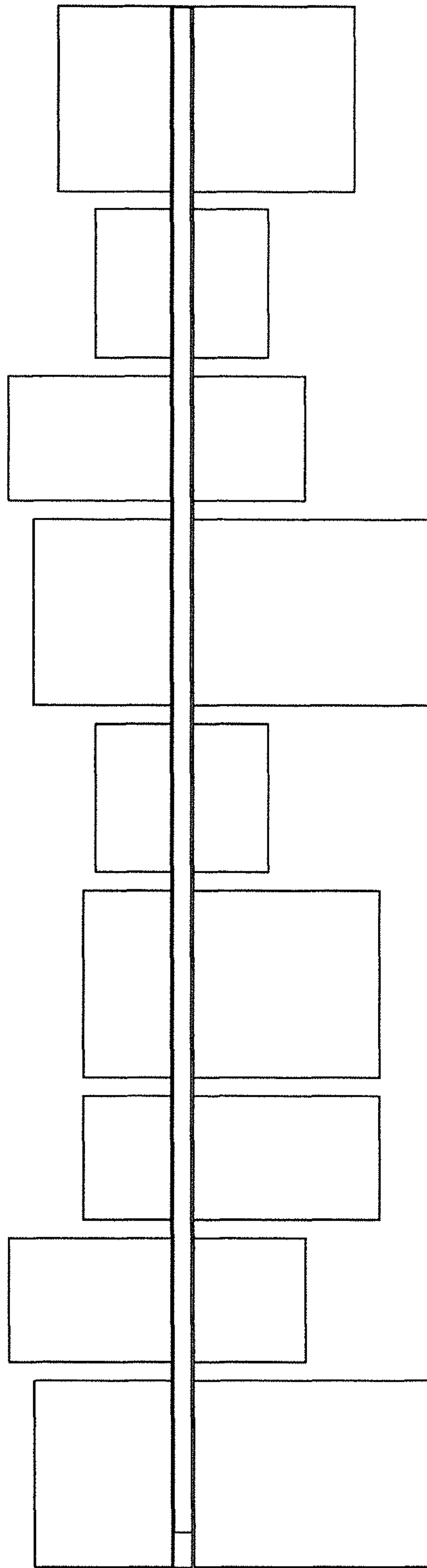

FIG. 23

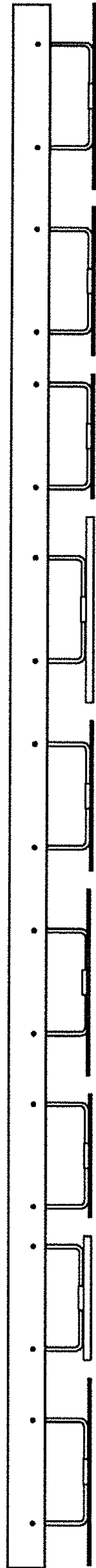

FIG. 24

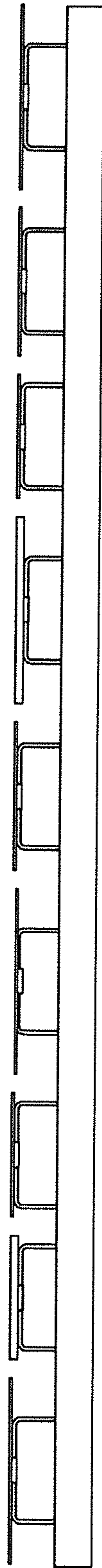

FIG. 25

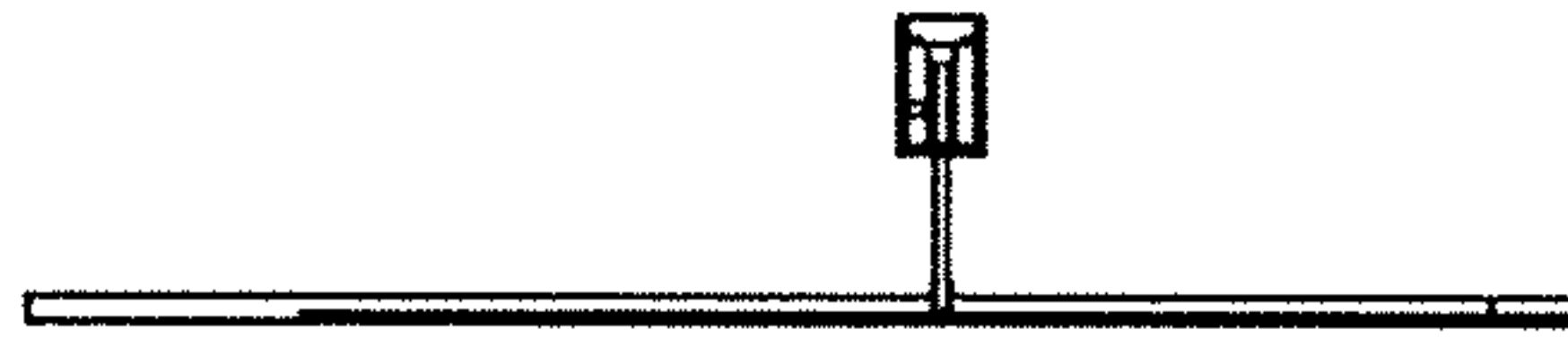

FIG. 26

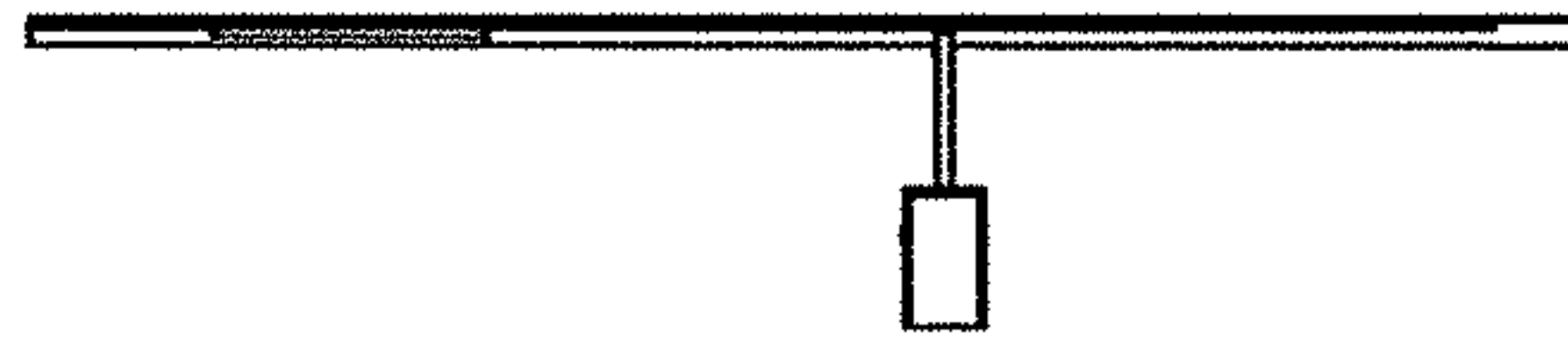

FIG. 27

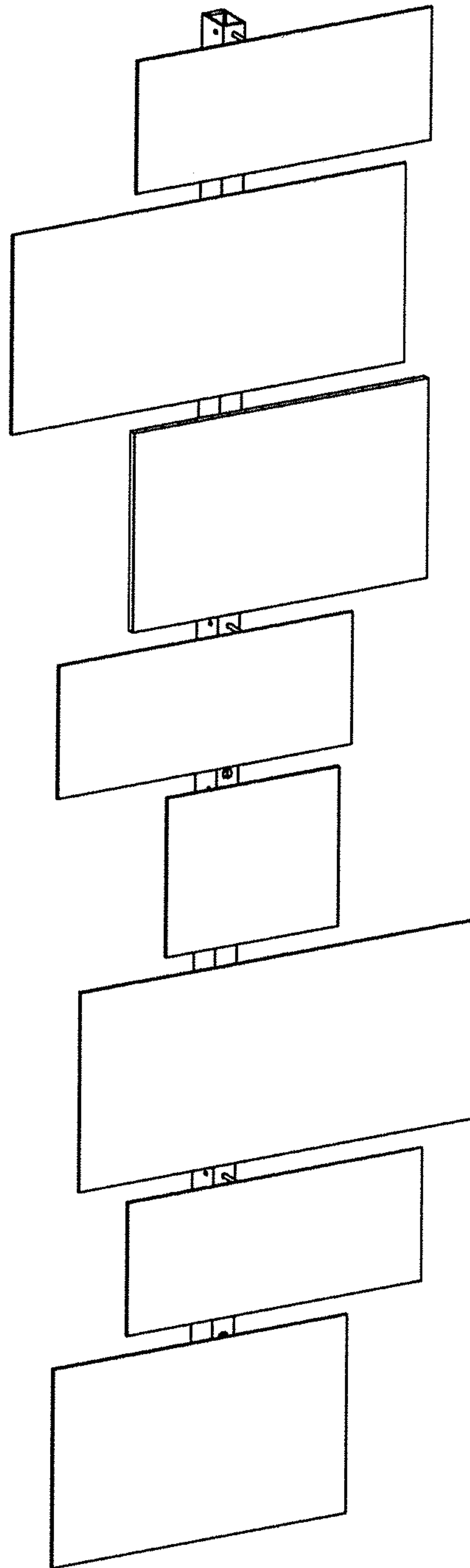

FIG. 28

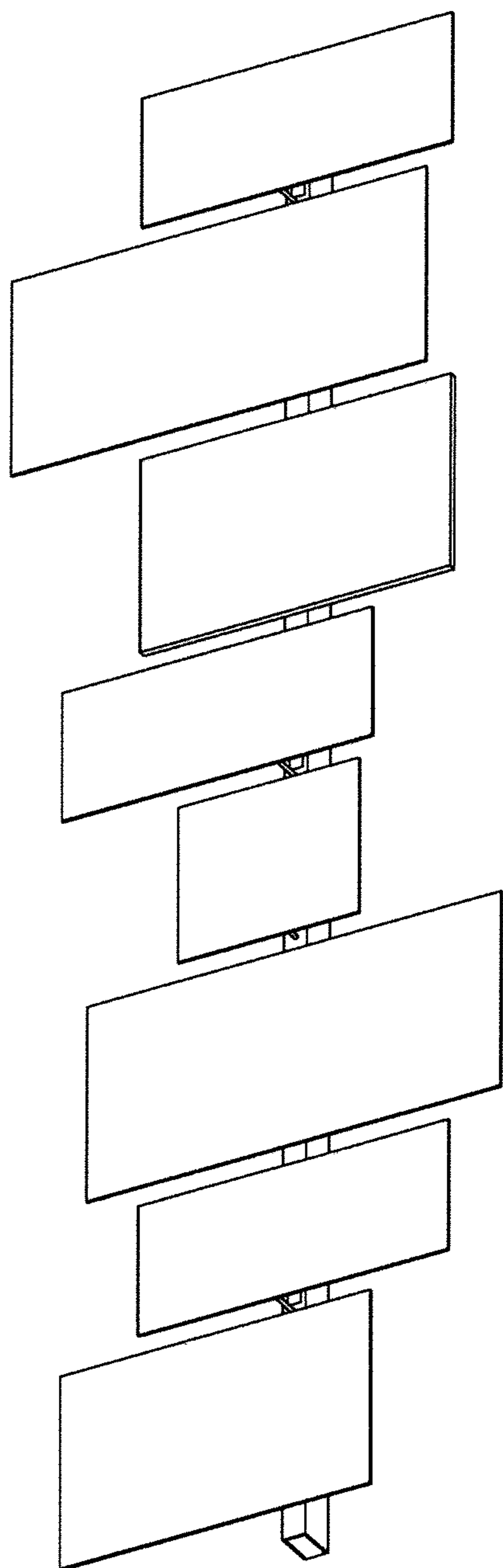

FIG. 29

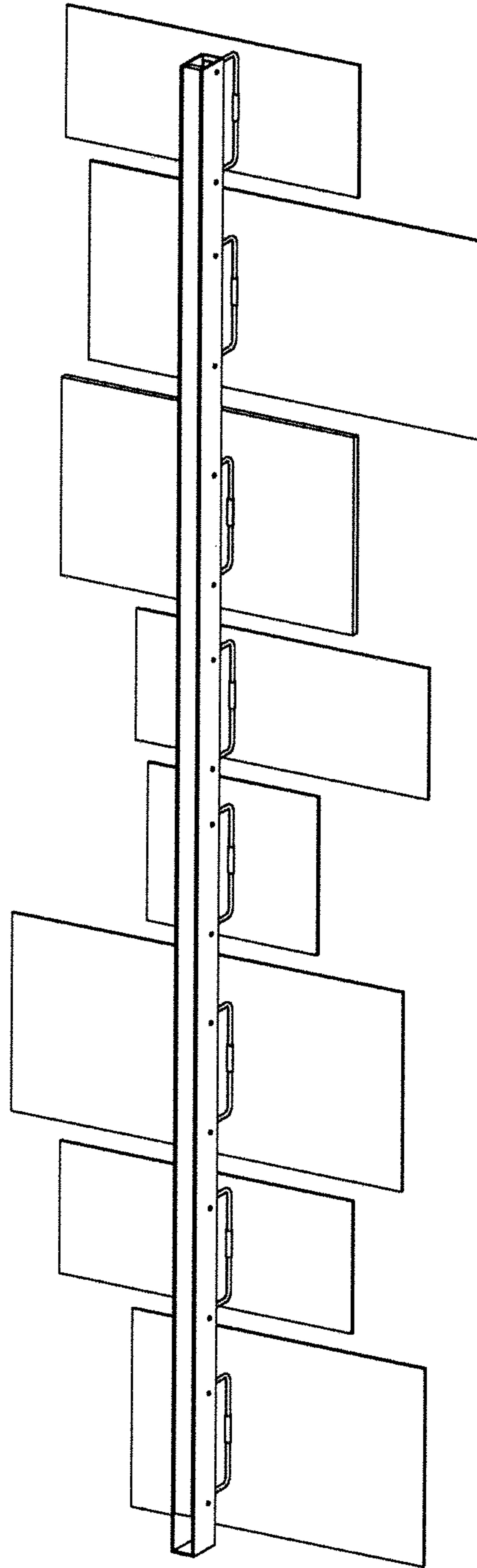

FIG. 30

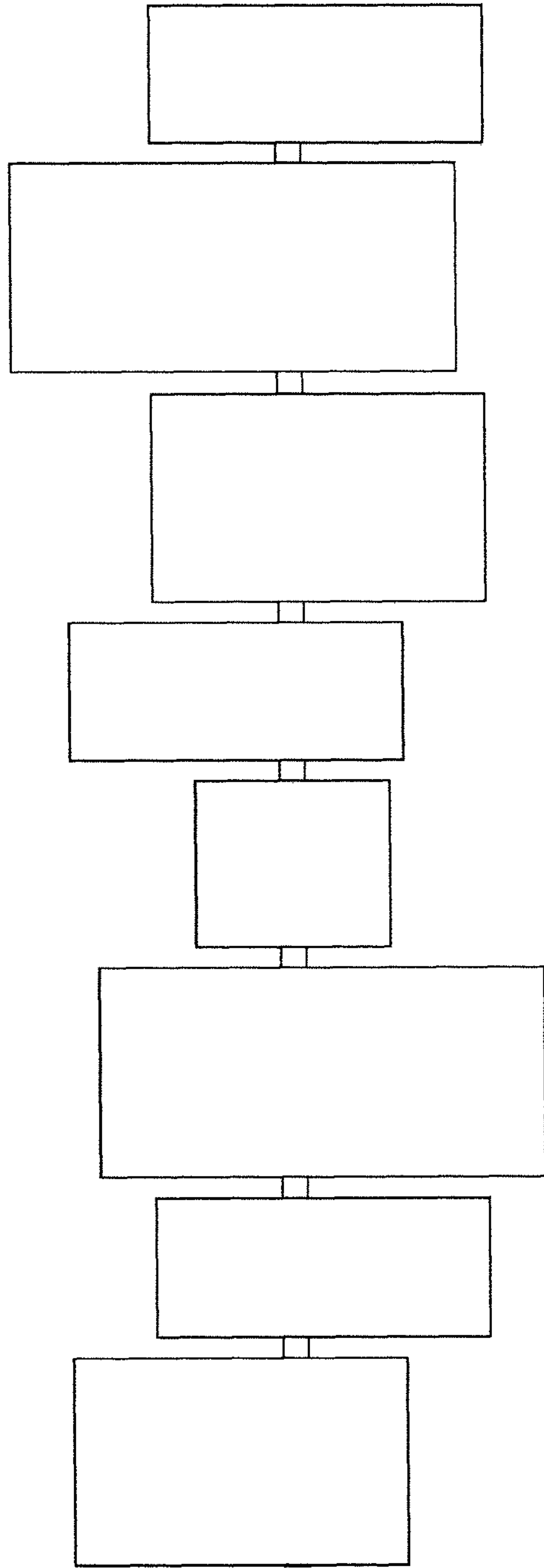

FIG. 31

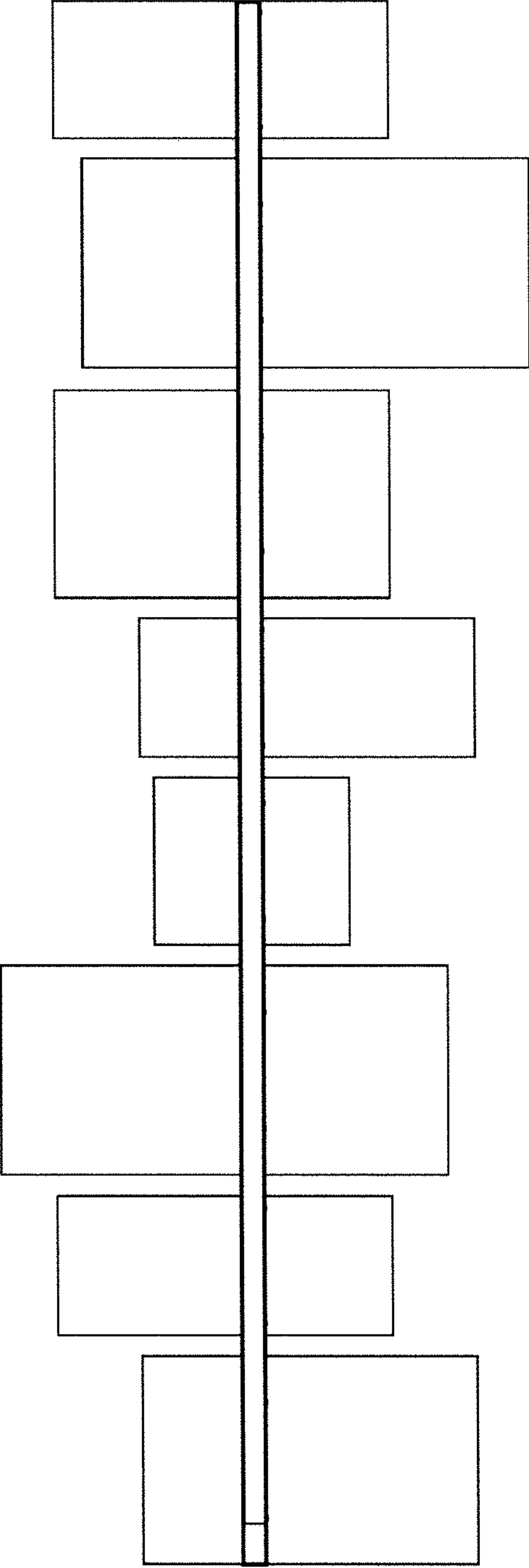

FIG. 32

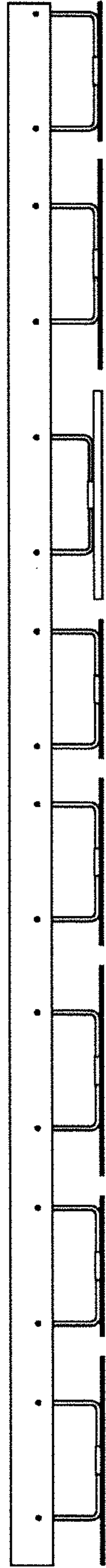

FIG. 33

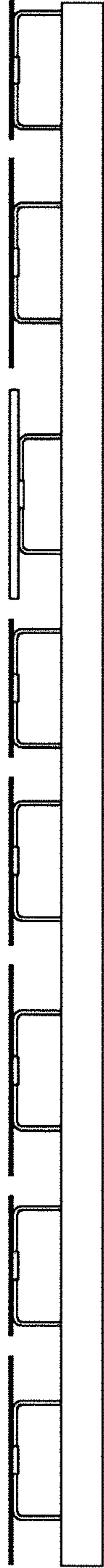

FIG. 34

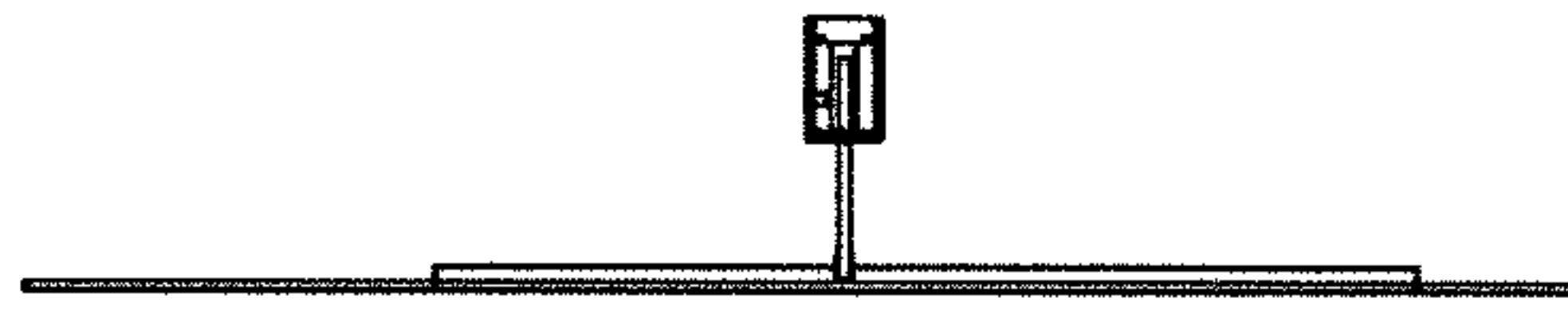

FIG. 35

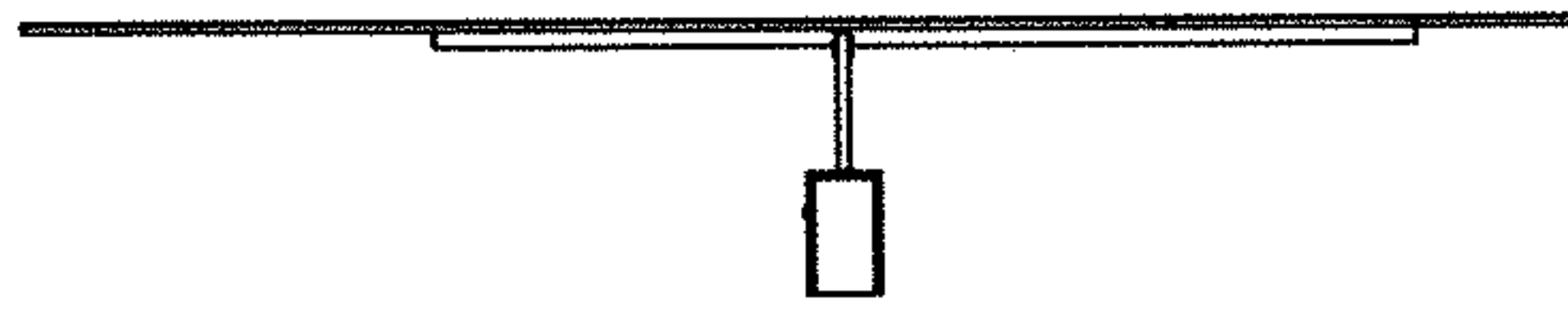

FIG. 36

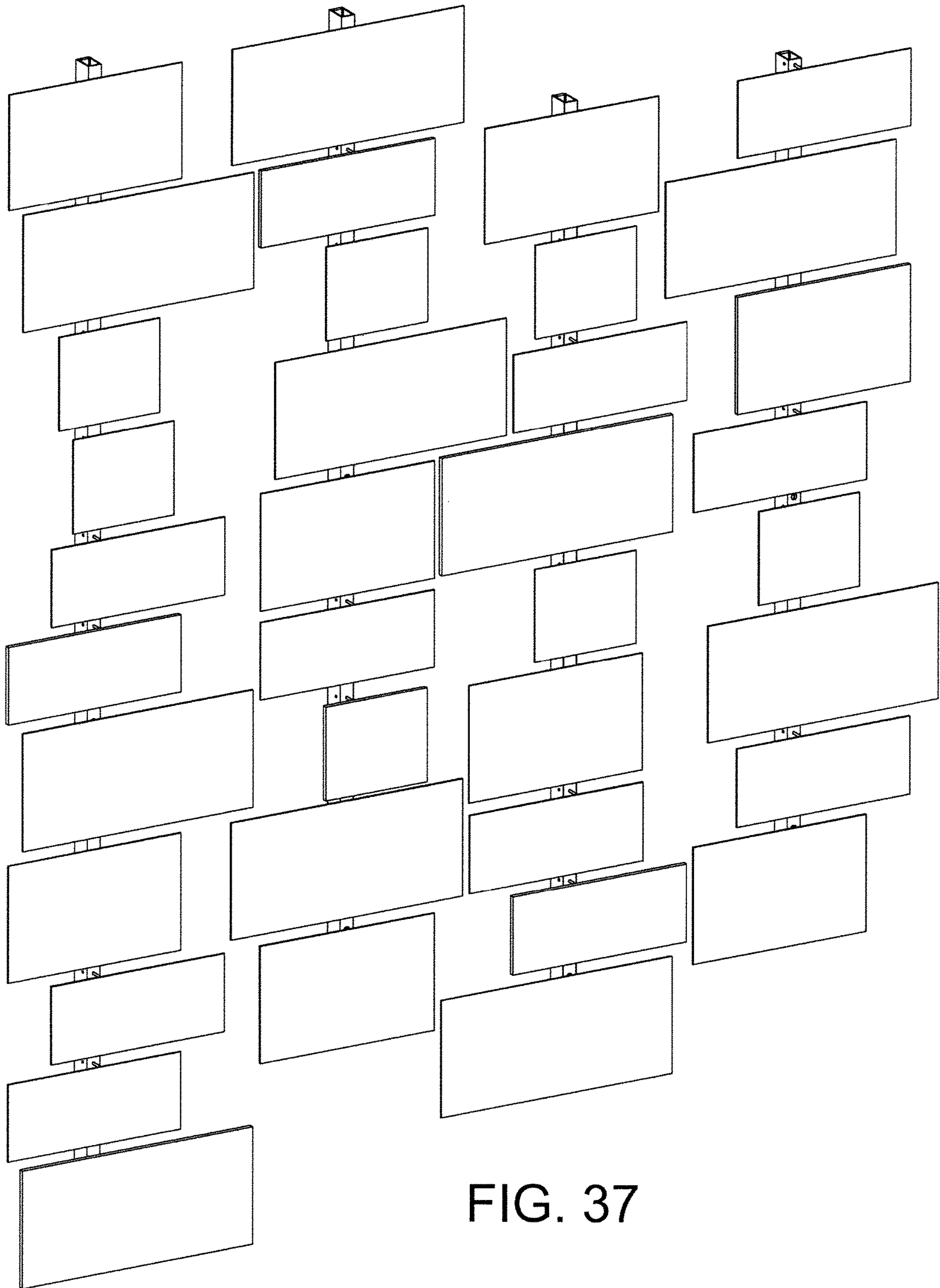

FIG. 37

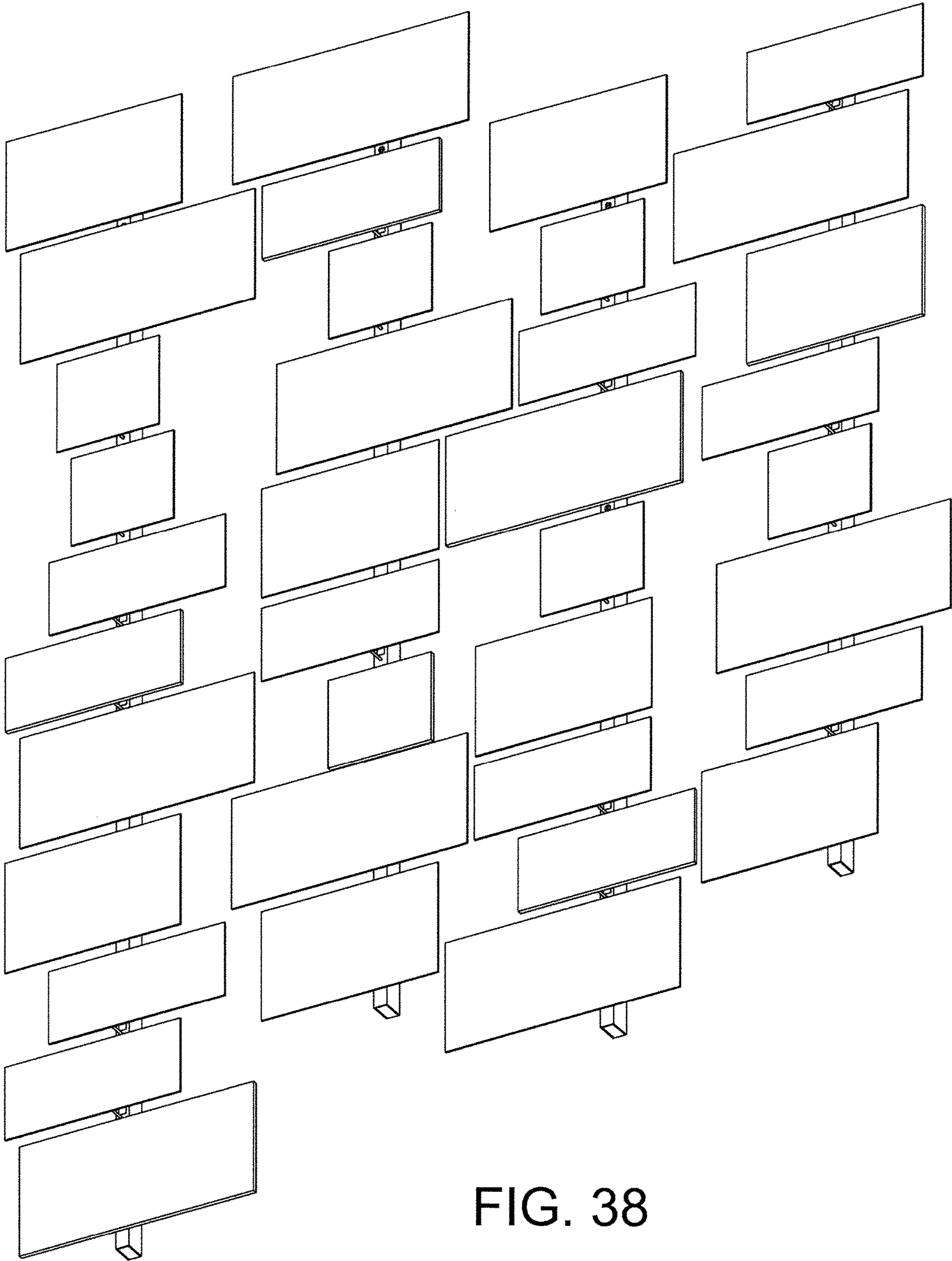

FIG. 38

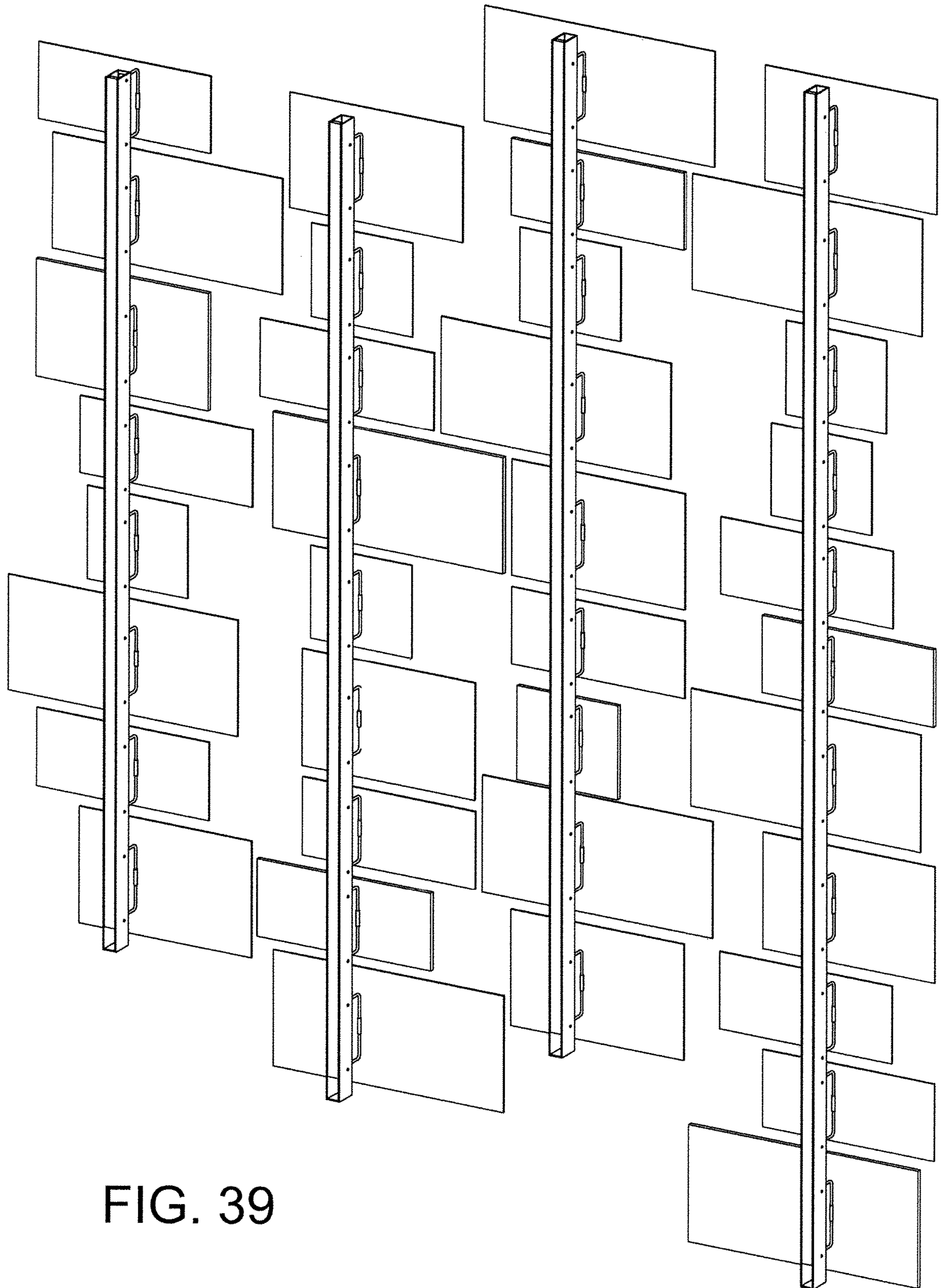

FIG. 39

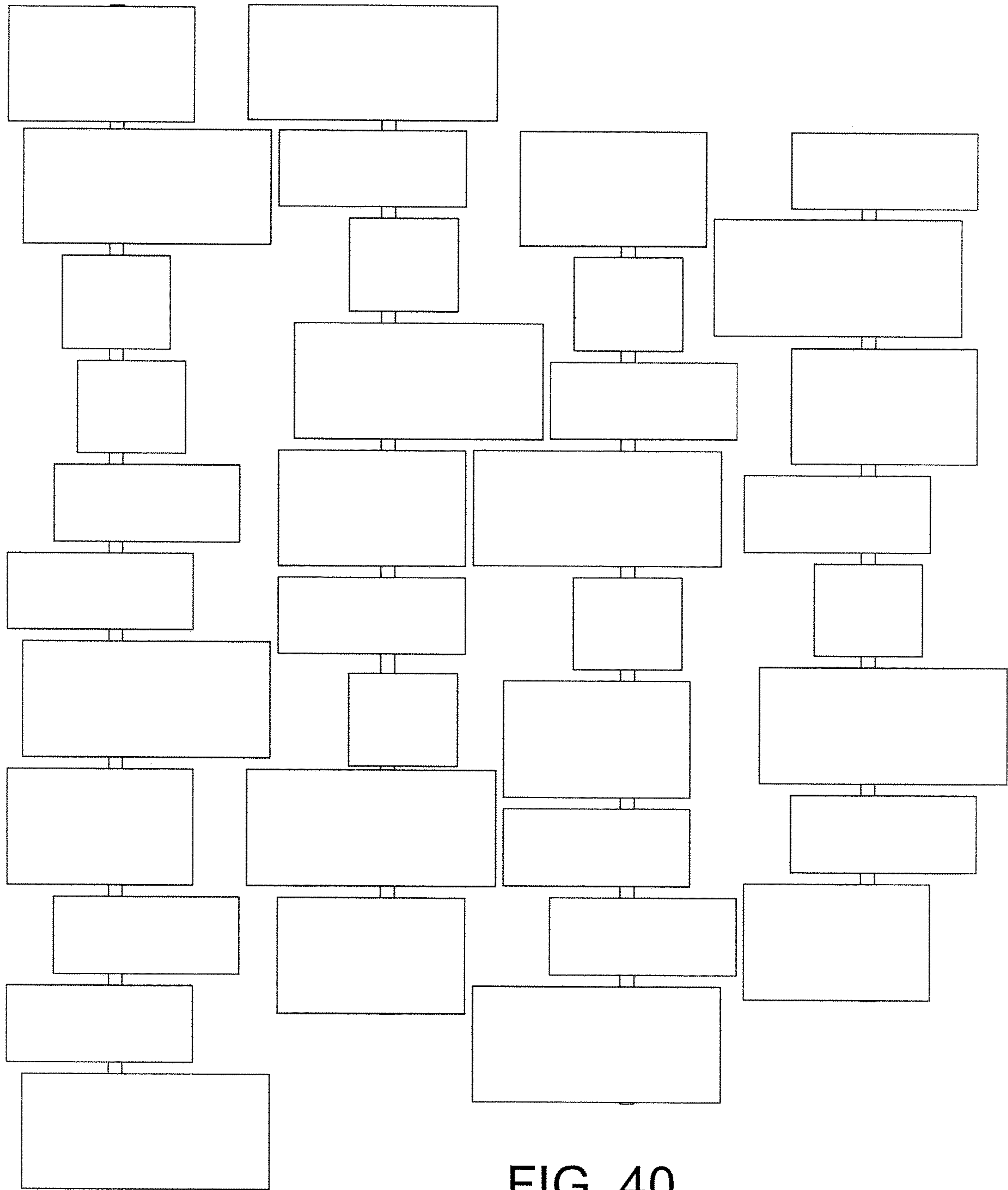

FIG. 40

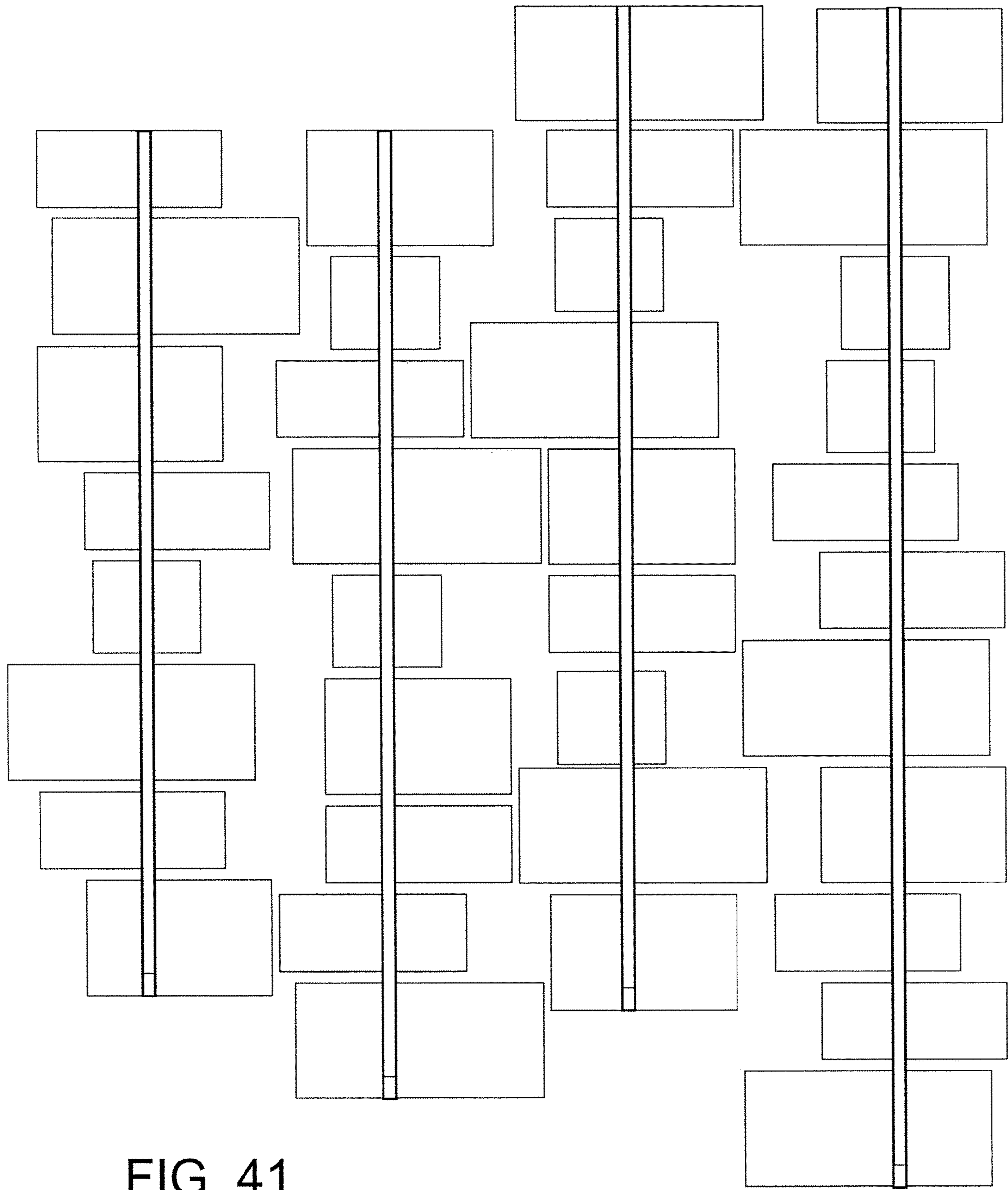

FIG. 41

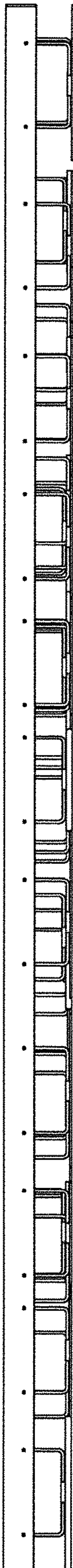

FIG. 42

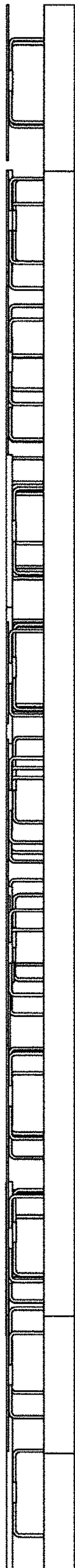

FIG. 43

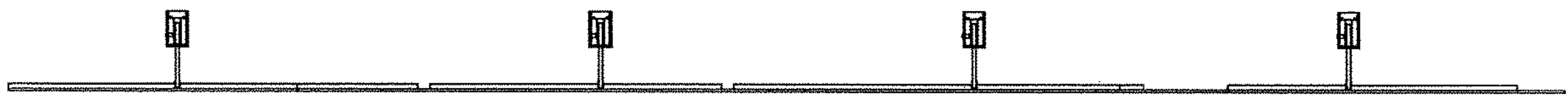

FIG. 44



FIG. 45