



US00D955494S

(12) **United States Design Patent** (10) **Patent No.:** **US D955,494 S**
Chambers et al. (45) **Date of Patent:** **** Jun. 21, 2022**

(54) **GAMING MACHINE WITH MODULAR TOPPER**

internet URL: <https://www.linsnled.com/jackpot-gaming-led-display-solutions.html> (Year: 2017).*

(71) Applicant: **Aristocrat Technologies, Inc. (ATI)**, Las Vegas, NV (US)

Primary Examiner — Garth Rademaker
Assistant Examiner — Salamah Jordan

(72) Inventors: **Keith Chambers**, Las Vegas, NV (US); **John Curtis**, Biddaddaba (AU); **Daniel Egar**, Upper Coomera (AU); **Scott Hendrickson**, Las Vegas, NV (US)

(74) *Attorney, Agent, or Firm* — McAndrews Held & Malloy, Ltd.

(73) Assignee: **ARISTOCRAT TECHNOLOGIES, INC.**, Las Vegas, NV (US)

(57) **CLAIM**

(**) Term: **15 Years**

The ornamental design for a gaming machine with modular topper, as shown and described.

(21) Appl. No.: **29/739,022**

(22) Filed: **Jun. 22, 2020**

DESCRIPTION

(51) **LOC (13) Cl.** **21-03**

(52) **U.S. Cl.**
USPC **D21/369**

(58) **Field of Classification Search**
USPC D14/374, 341, 307, 173, 140.8, 138 R,
D14/127, 486, 172, 107; D21/325, 329,
D21/369, 371, 370, 385, 394
(Continued)

FIG. 1 is a front perspective view of embodiment one, of a gaming machine with modular topper shown in environmental use, showing our new design;
FIG. 2 is an exploded front perspective view thereof;
FIG. 3 is an exploded front elevation view thereof;
FIG. 4 is an exploded rear elevation view thereof;
FIG. 5 is a left side elevation view thereof;
FIG. 6 is a right side elevation view thereof;
FIG. 7 is an exploded top plan view thereof;
FIG. 8 is a front perspective view of embodiment two, of a gaming machine with modular topper, shown in environmental use, showing our new design;
FIG. 9 is an exploded front perspective view thereof;
FIG. 10 is an exploded front elevation view thereof;
FIG. 11 is an exploded rear elevation view thereof;
FIG. 12 is a left side elevation view thereof;
FIG. 13 is a right side elevation view thereof;
FIG. 14 is an exploded top plan view thereof;
FIG. 15 is a front perspective view of embodiment three of a gaming machine with modular topper, shown in environmental use, showing our new design;
FIG. 16 is an exploded front perspective view thereof;
FIG. 17 is an exploded front elevation view thereof;
FIG. 18 is an exploded rear view thereof;

(56) **References Cited**

U.S. PATENT DOCUMENTS

D383,802 S * 9/1997 Levy D21/370
D450,096 S * 11/2001 Legras D21/325
(Continued)

FOREIGN PATENT DOCUMENTS

AU 201810719 5/2018
AU 201812634 5/2018
(Continued)

OTHER PUBLICATIONS

Jackpot Gaming Led Display, first available May 25, 2017, www.linsnled.com [online], site visited Jan. 6, 2022], Available from

(Continued)

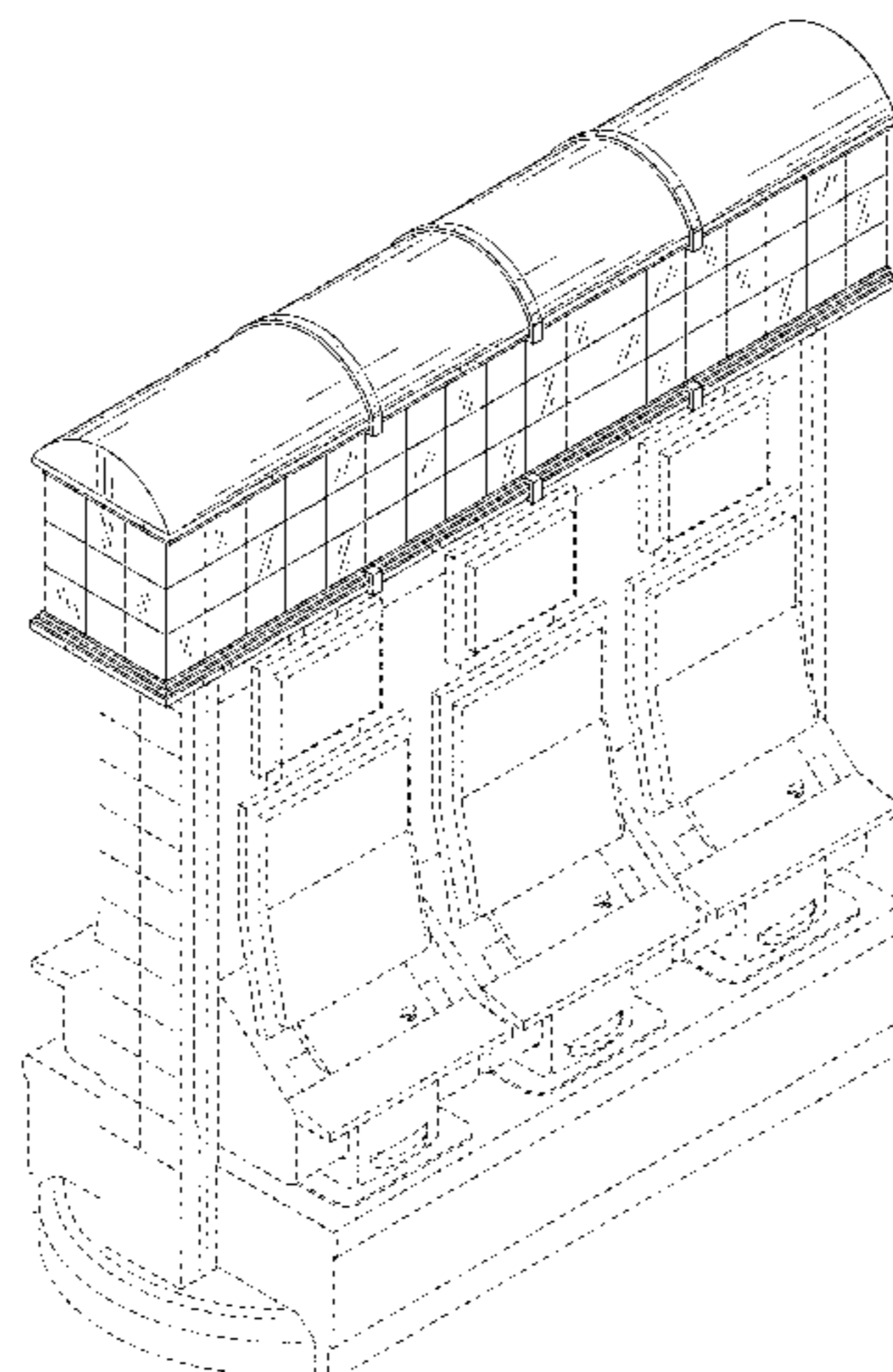

FIG. 19 is a left side elevation view thereof;
 FIG. 20 is a right side elevation view thereof; and,
 FIG. 21 is an exploded top plan view thereof.
 The broken lines in the figures illustrate portions of the
 gaming machine with modular topper that form no part of
 the claimed design.

1 Claim, 15 Drawing Sheets

(58) **Field of Classification Search**

CPC A63F 9/0406; A63F 5/02; A63F 5/045;
 A63F 13/20; A63F 13/25; A63F 3/00157;
 B60R 13/00; B43L 1/06; G09F 21/04;
 G07F 17/34; G07F 17/3211; G07F
 17/3213; G07F 17/3216; G07F 17/3244;
 G07F 17/3267

See application file for complete search history.

(56)

References Cited

U.S. PATENT DOCUMENTS

D484,550	S	*	12/2003	Seelig	D21/370
D508,719	S	*	8/2005	de Haas	D21/325
D513,523	S	*	1/2006	Crouch	D21/370
D628,656	S	*	12/2010	Bruzzese	D21/385
D629,466	S	*	12/2010	Bruzzese	D21/385
D673,622	S	*	1/2013	Wudtke	D21/385
D706,359	S	*	6/2014	Wudtke	D21/385
D803,323	S	*	11/2017	Bussey	D21/369
D900,938	S	*	11/2020	Lesourd	D21/369
D934,236	S	*	10/2021	Giacomin	D14/307
2019/0287337	A1	*	9/2019	Shiraishi	G07F 17/3267

FOREIGN PATENT DOCUMENTS

AU	201812637	5/2018
AU	201812639	5/2018
AU	201812640	5/2018

* cited by examiner

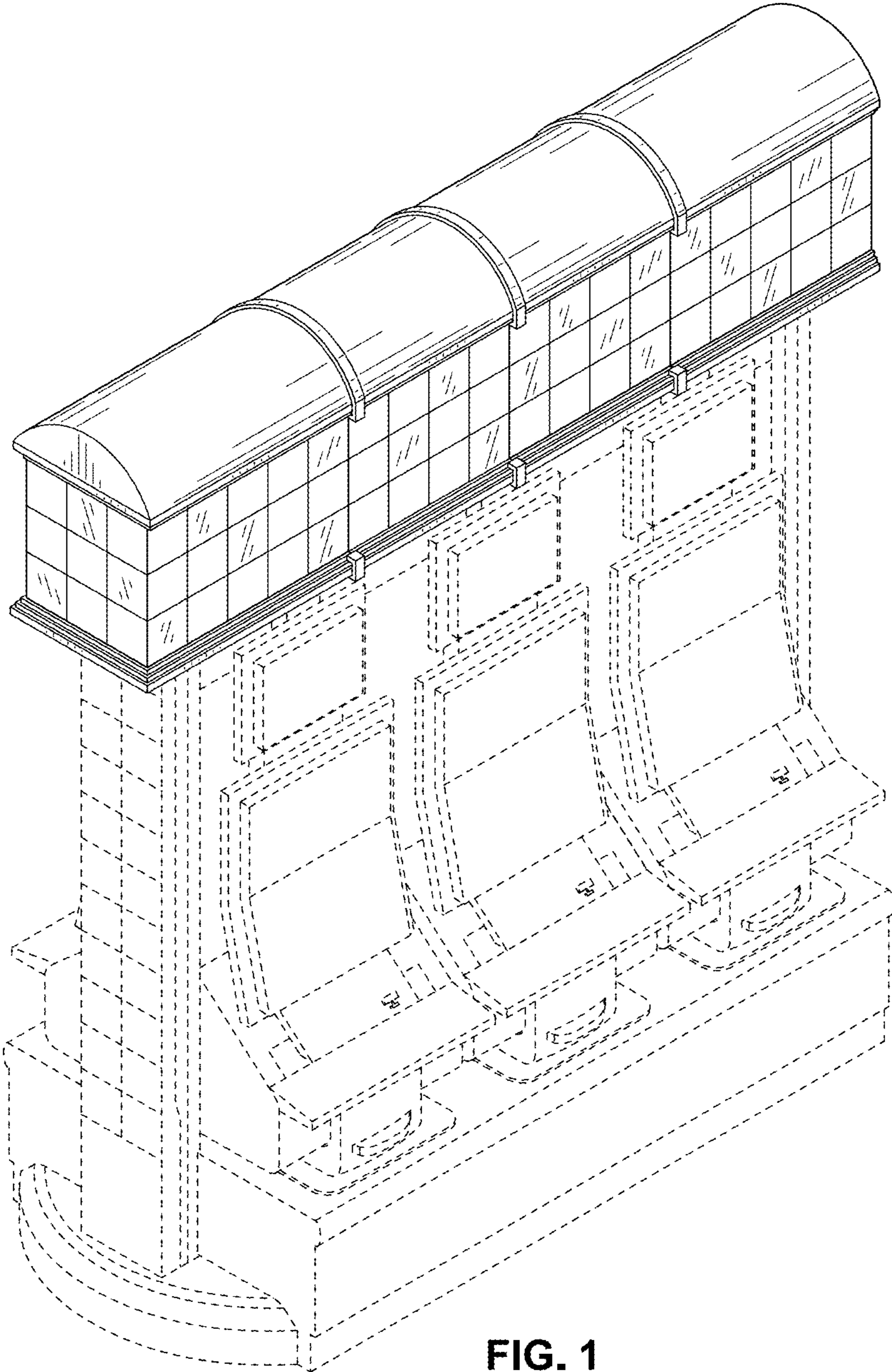

FIG. 1

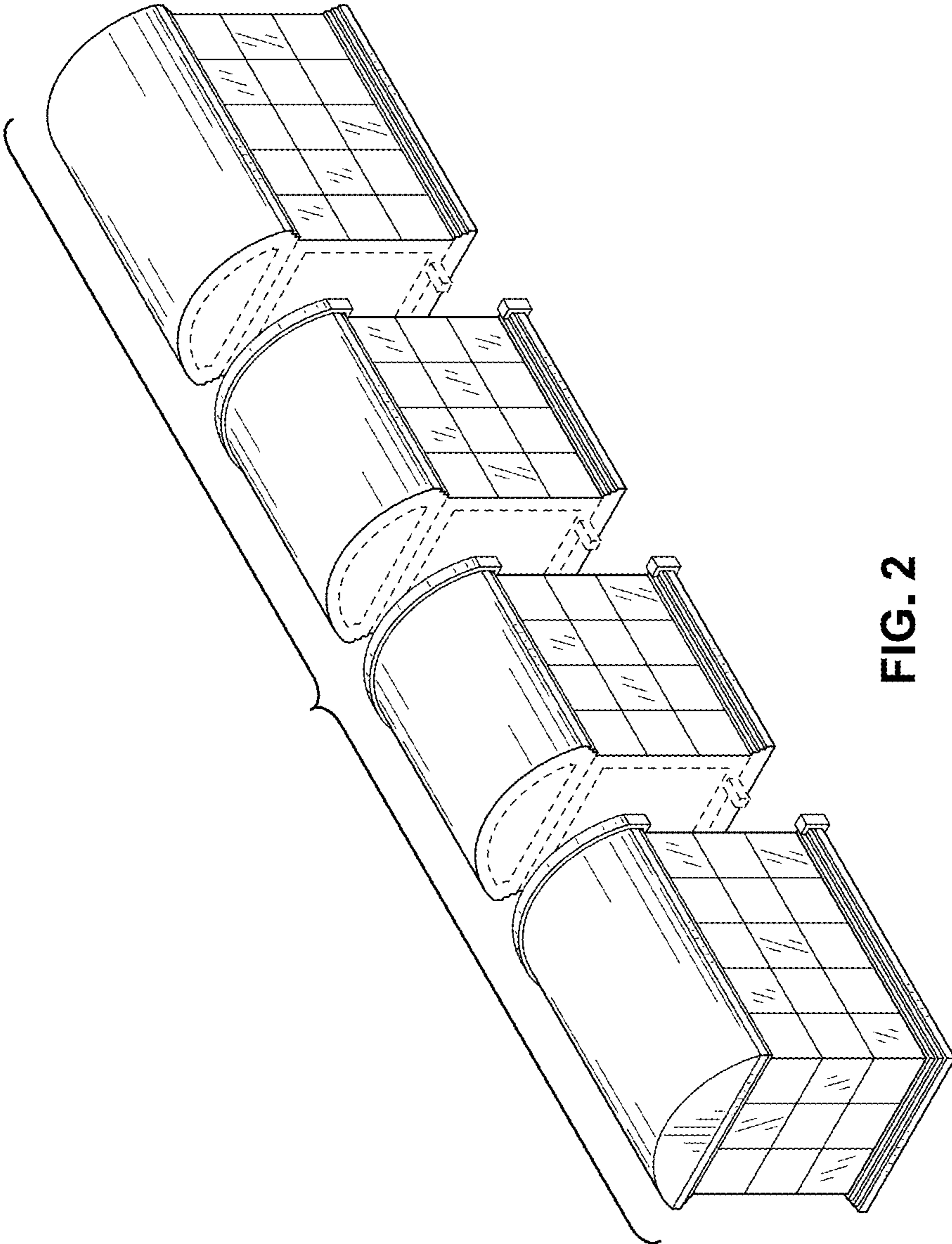

FIG. 2

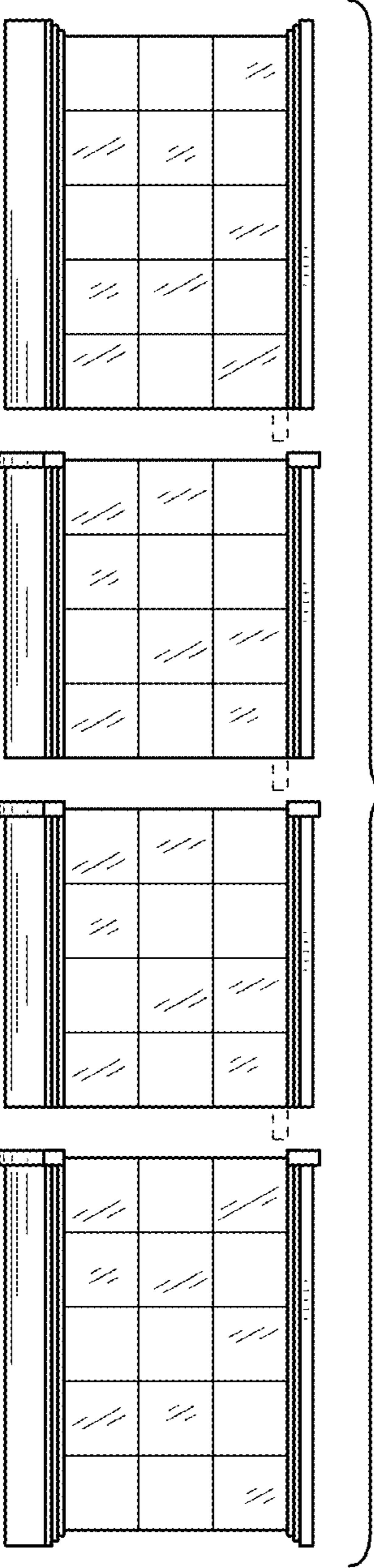

FIG. 3

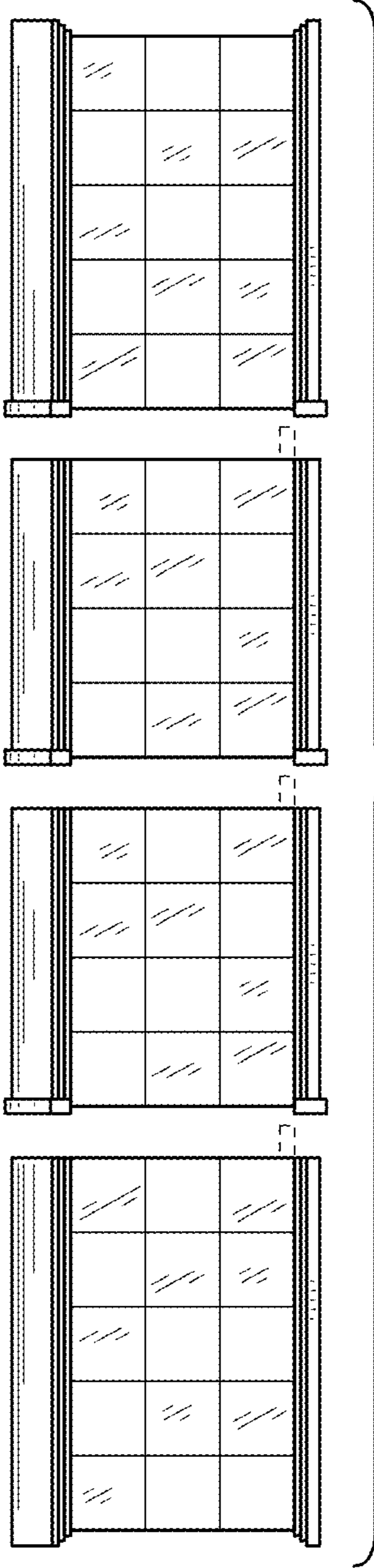

FIG. 4

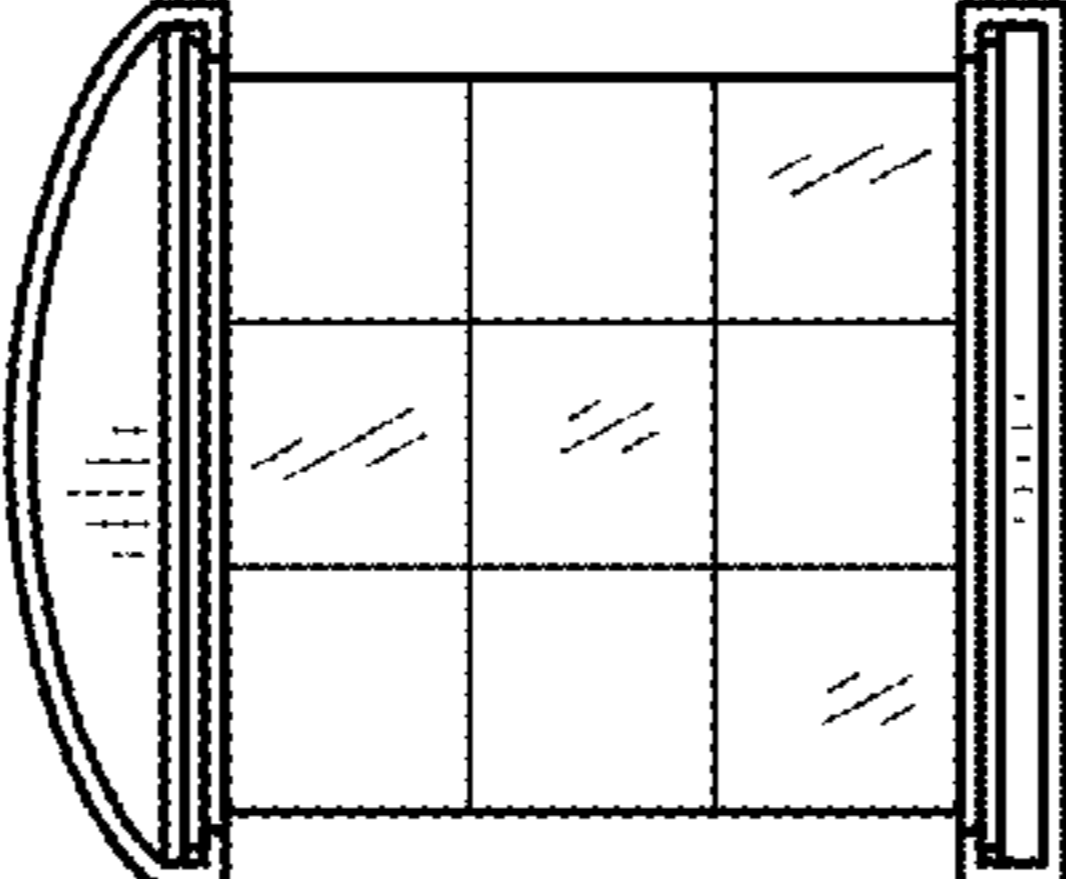

FIG. 5

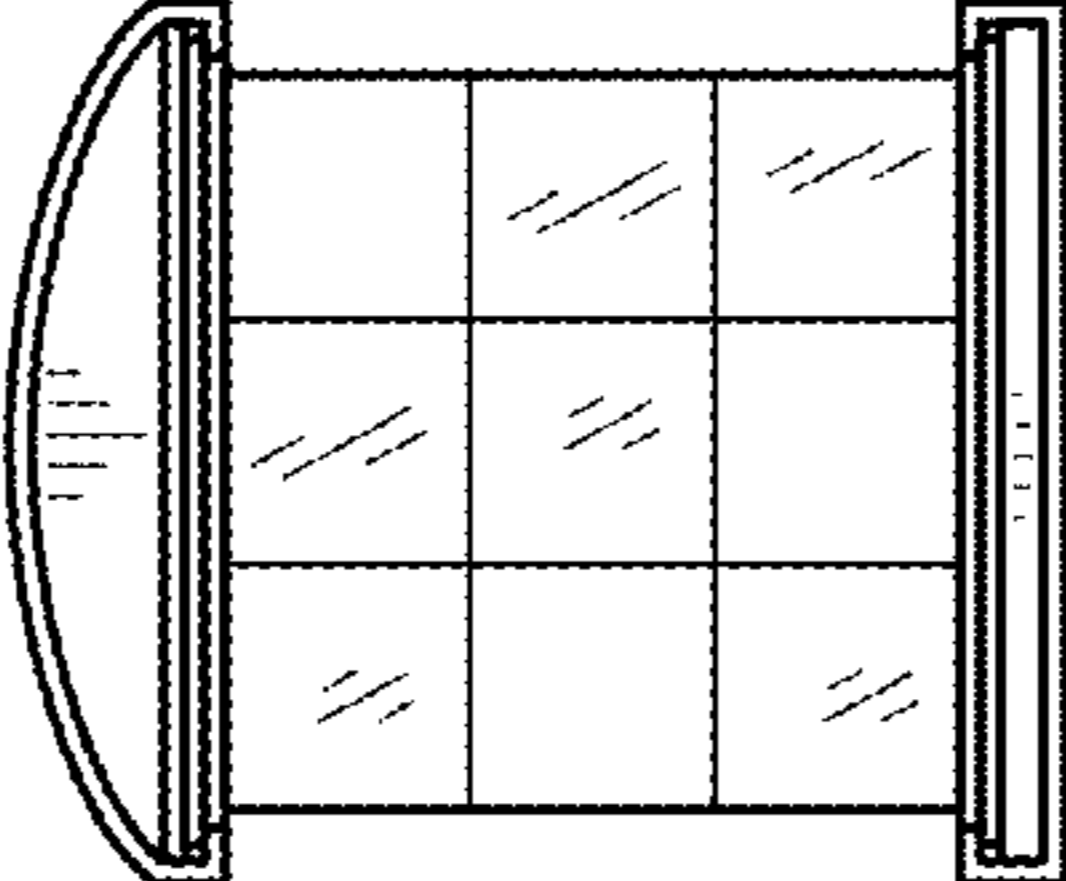
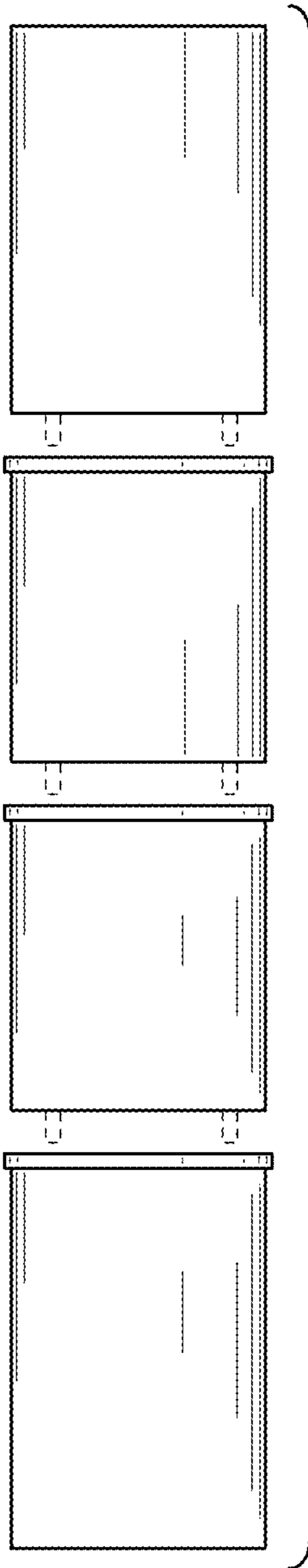

FIG. 6



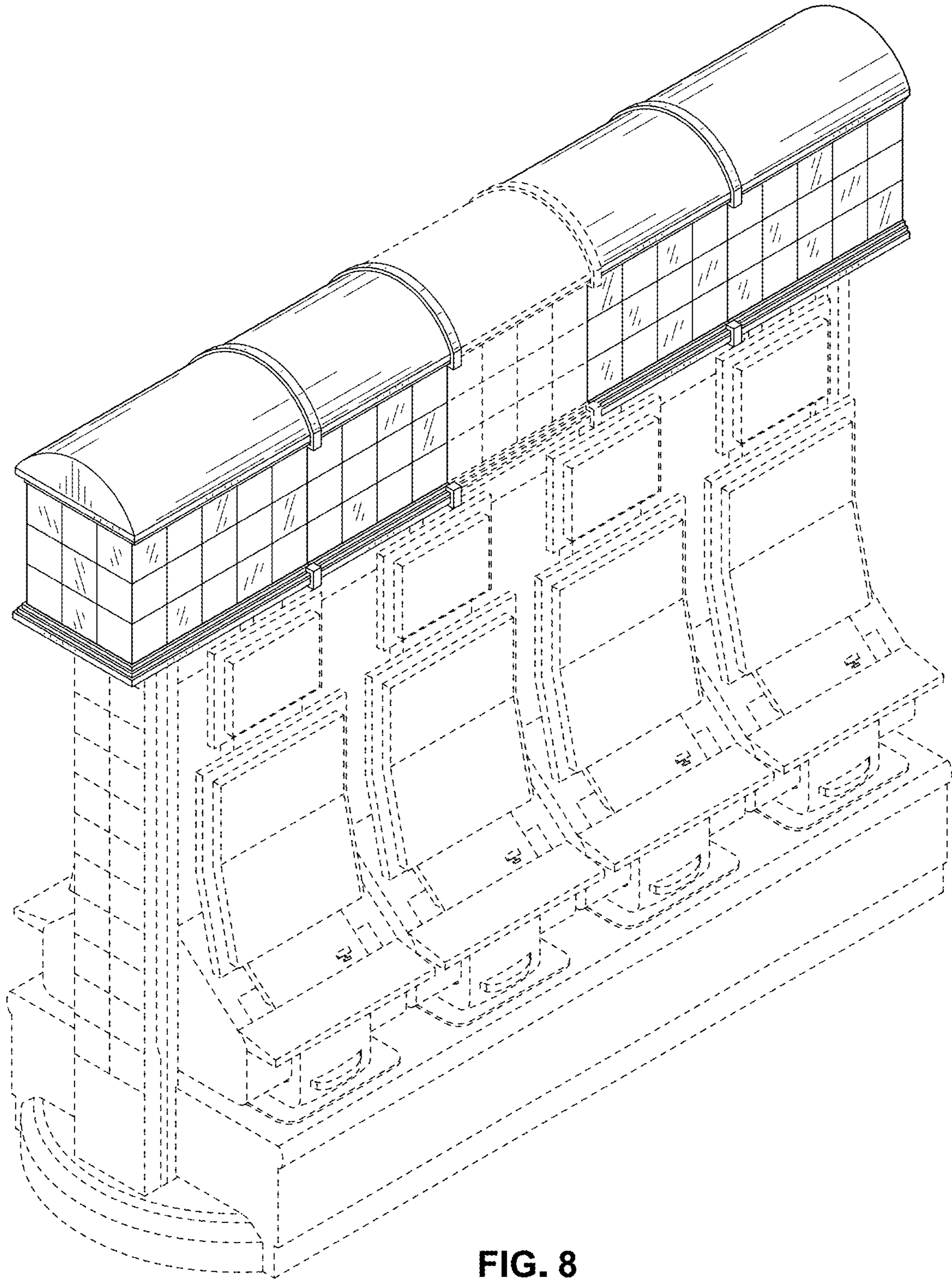

FIG. 8

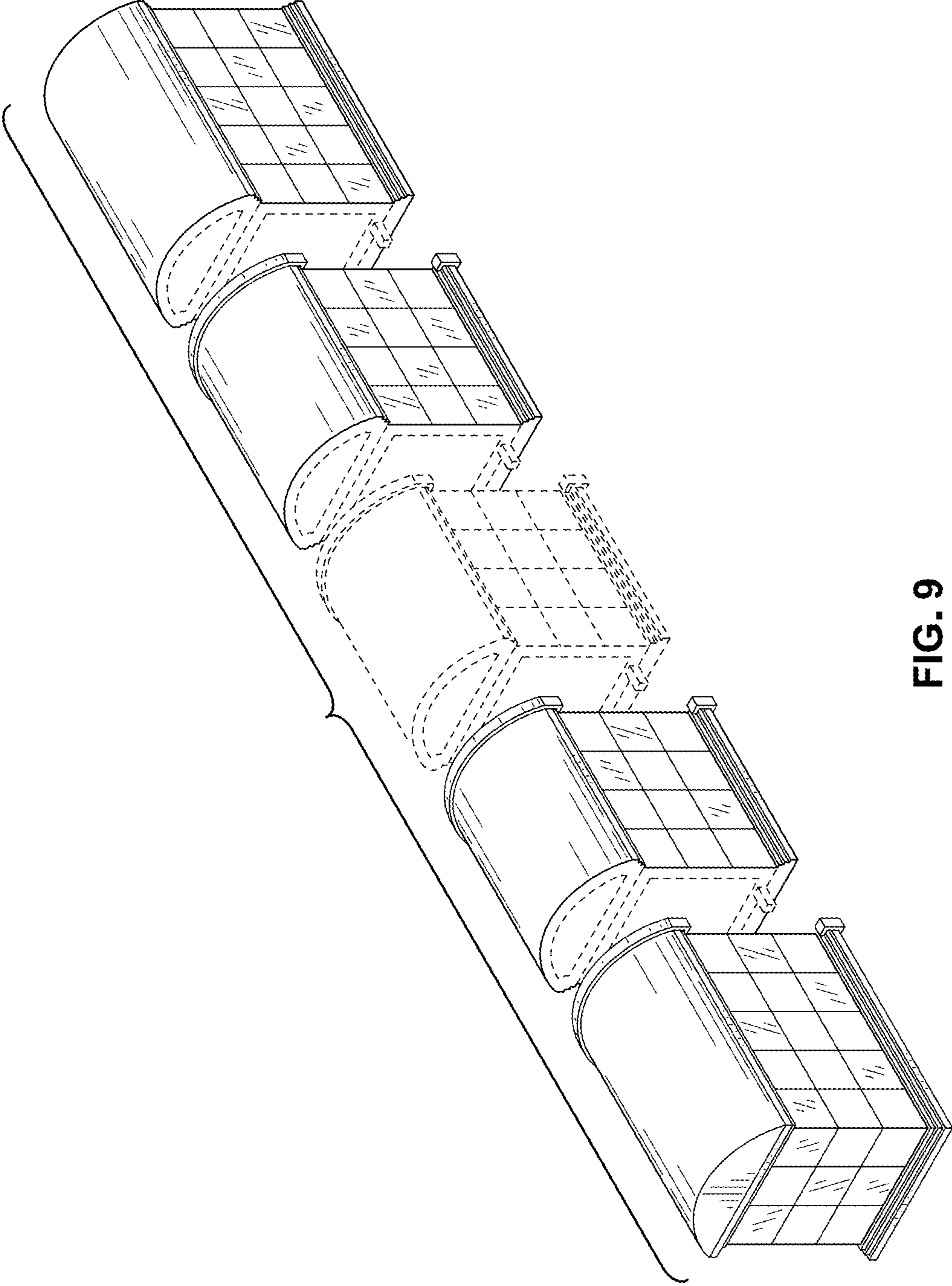
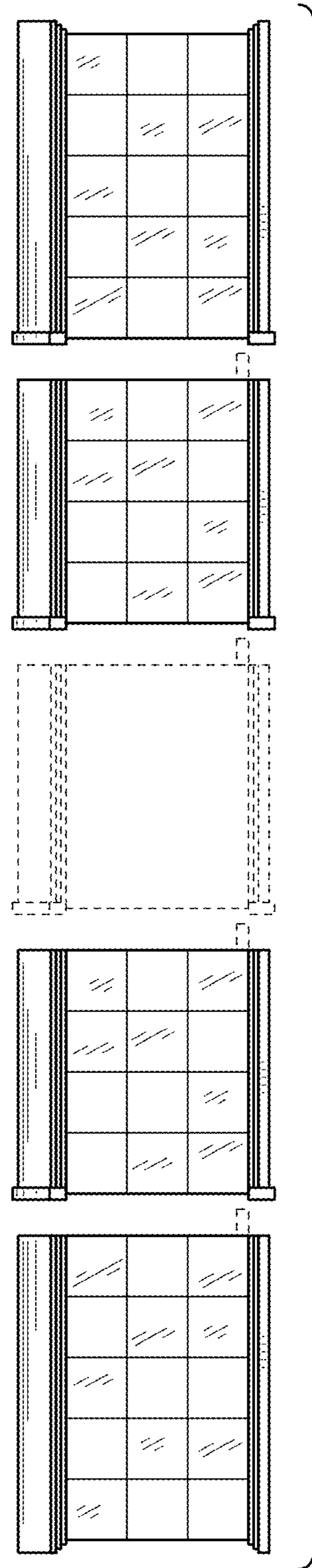
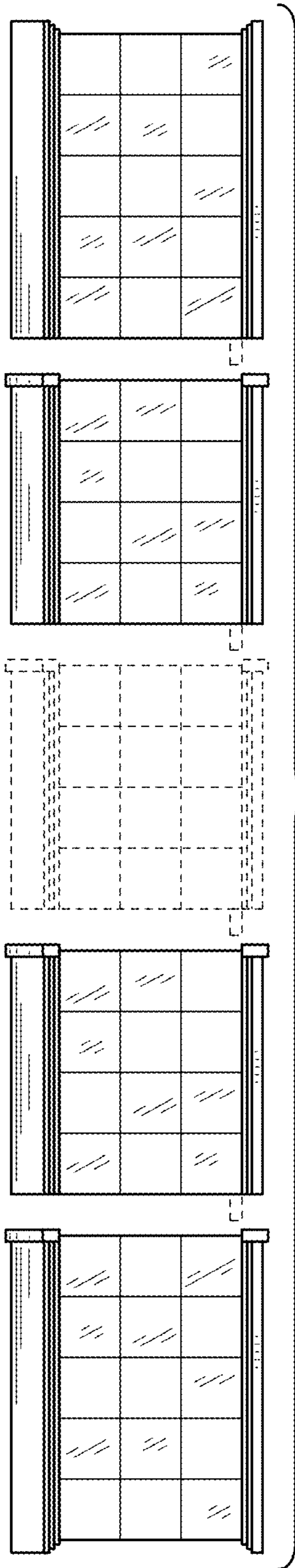

FIG. 9



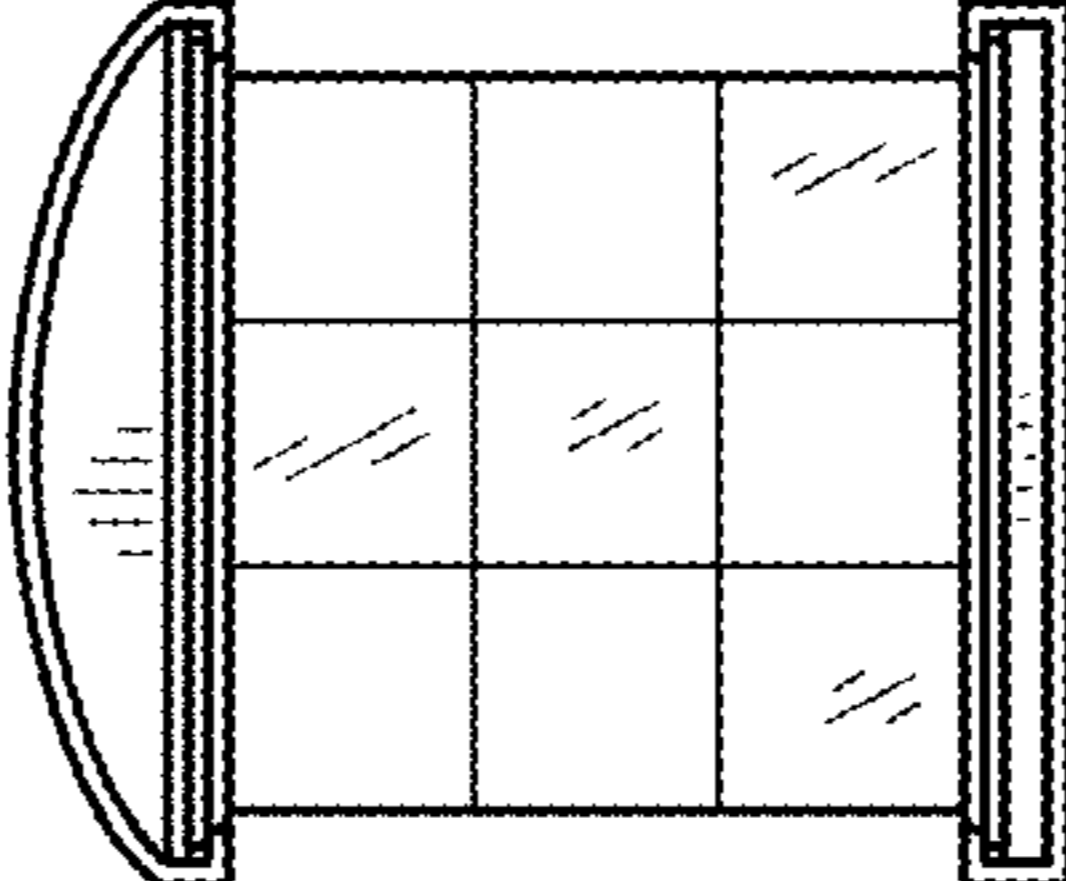

FIG. 12

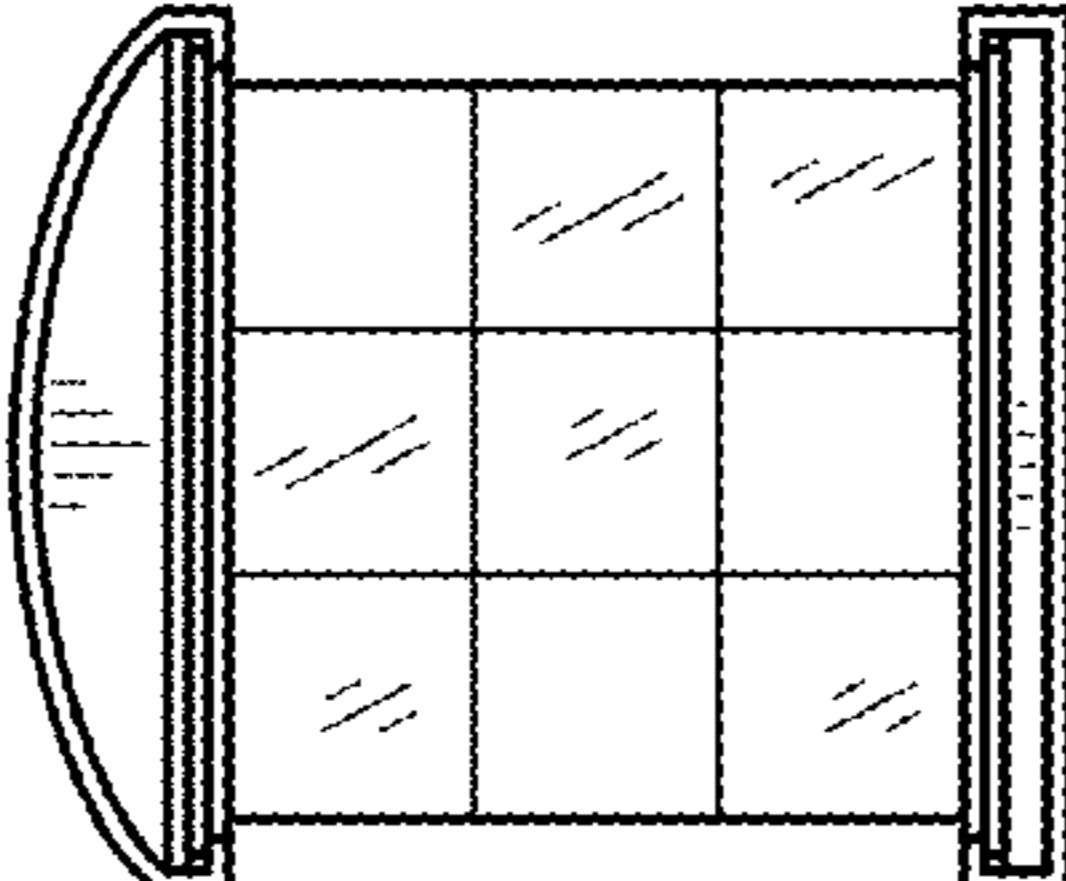

FIG. 13

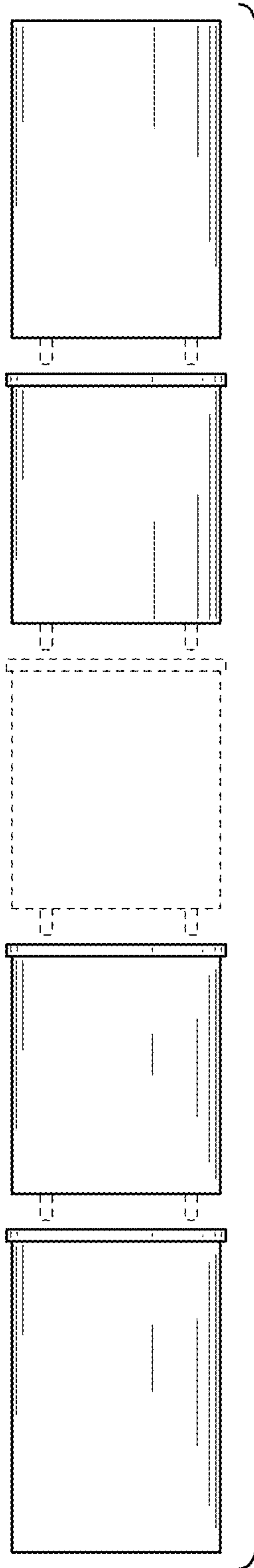

FIG. 14

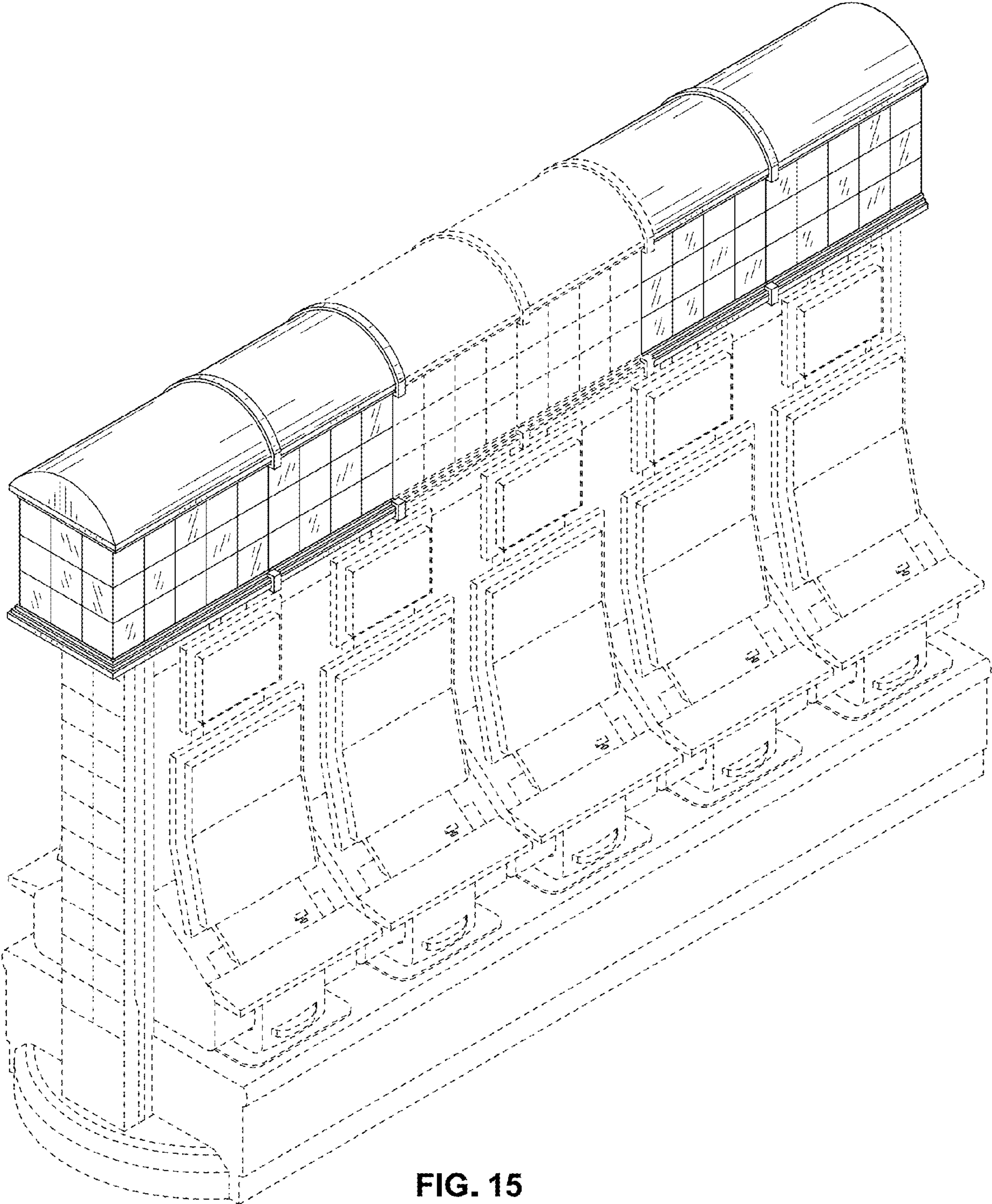

FIG. 15

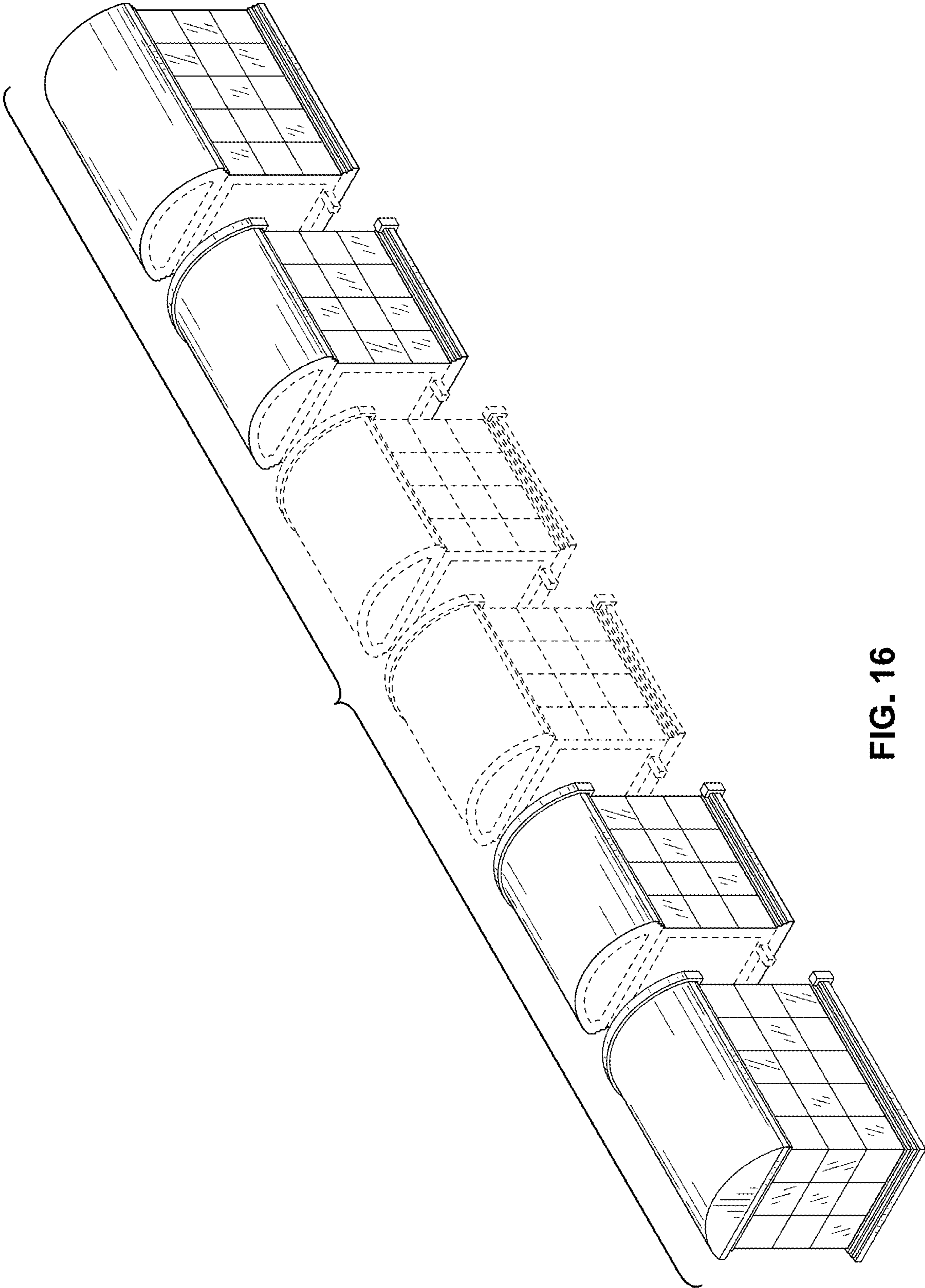

FIG. 16

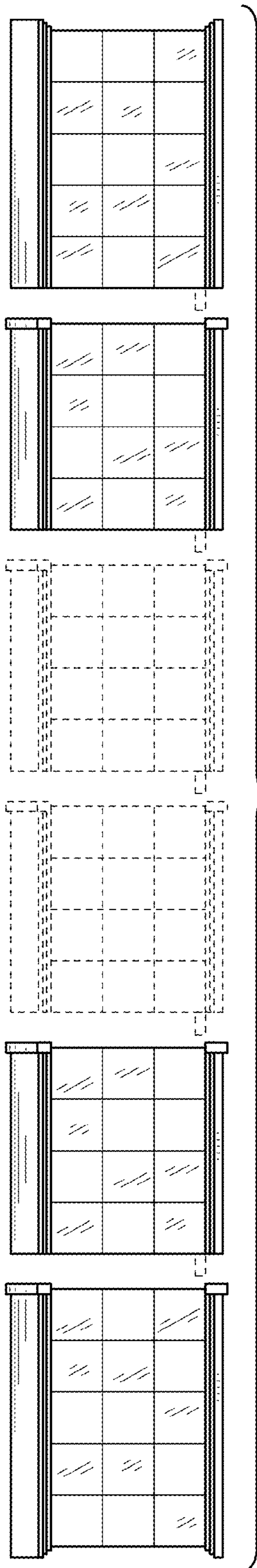

FIG. 17

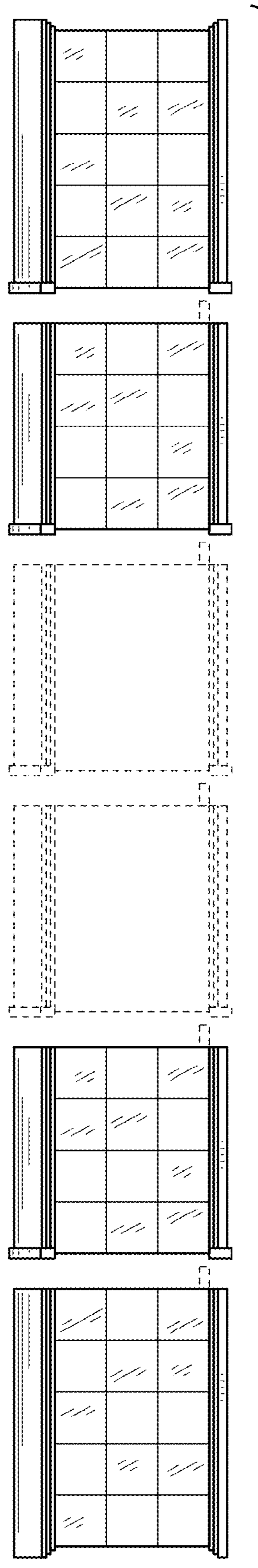

FIG. 18

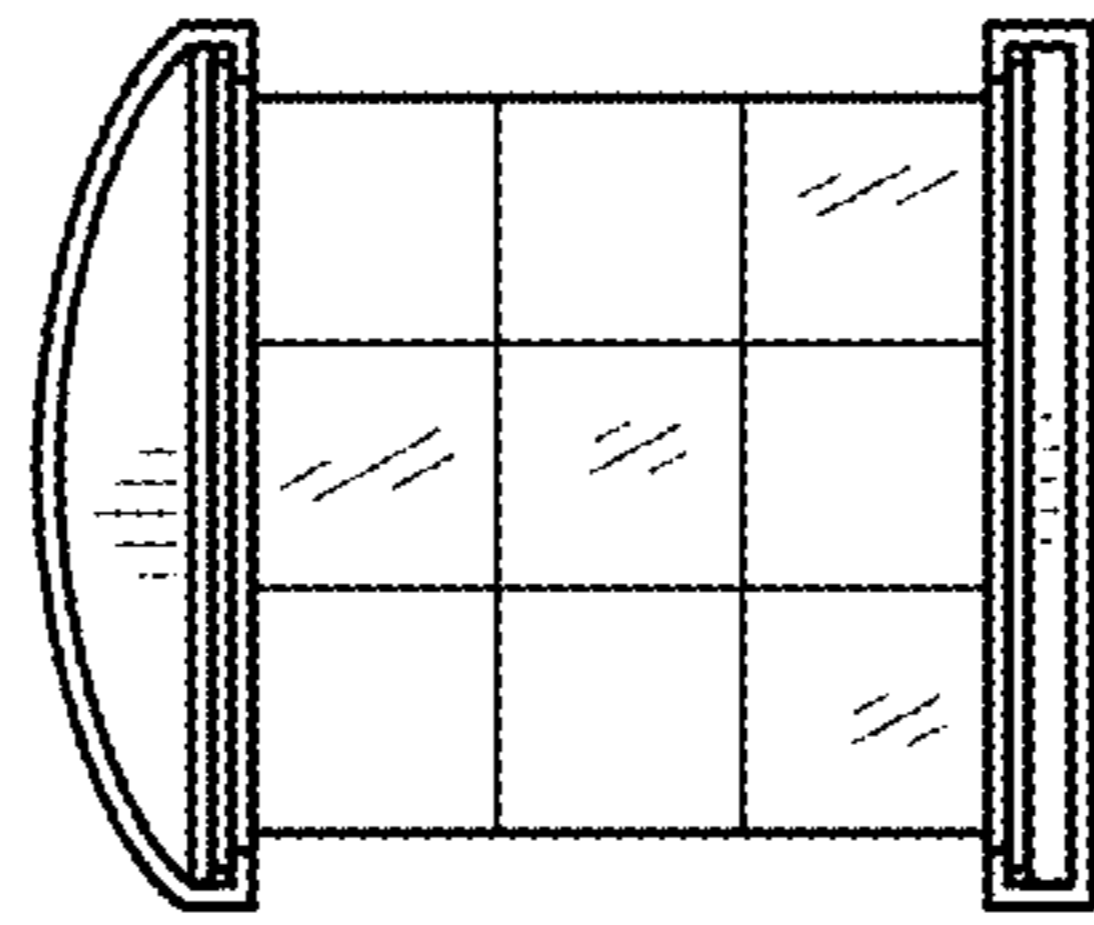

FIG. 20

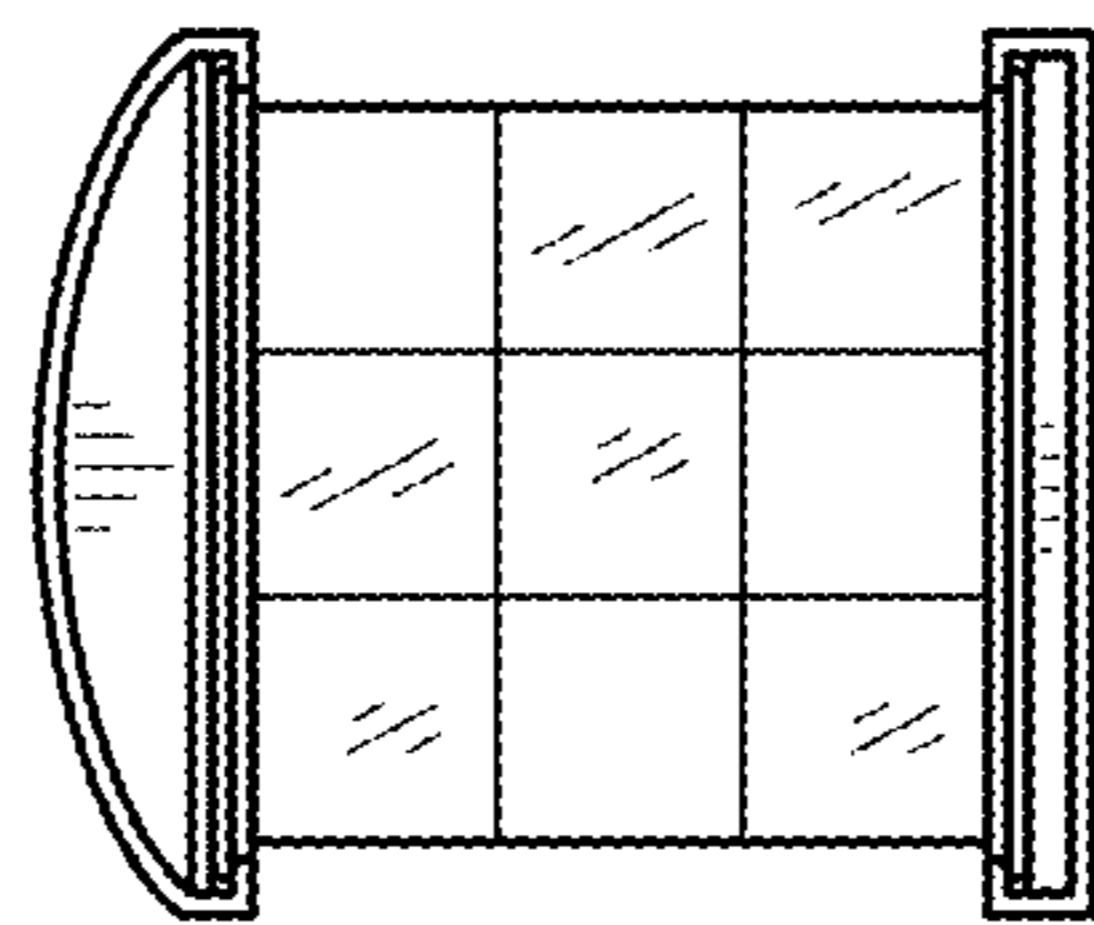

FIG. 19

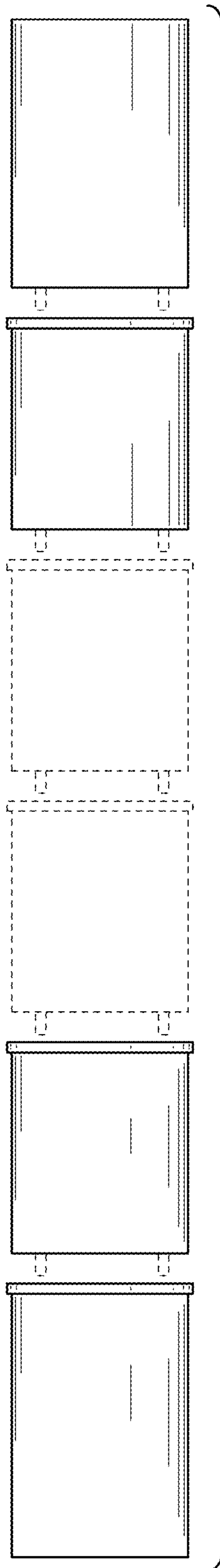

FIG. 21