



US00D955455S

(12) **United States Design Patent**
Matsui et al.

(10) **Patent No.: US D955,455 S**

(45) **Date of Patent: ** Jun. 21, 2022**

(54) **ROBOT**

(74) *Attorney, Agent, or Firm* — Leason Ellis LLP

(71) Applicant: **Google LLC**, Mountain View, CA (US)

(57) **CLAIM**

The ornamental design for a robot, as shown and described.

(72) Inventors: **Hideaki Matsui**, San Francisco, CA (US); **Arthur Kenzo Debaigue**, San Francisco, CA (US); **Guy Noren**, San Francisco, CA (US); **Keun young Park**, Santa Clara, CA (US); **Scott E. Stanford**, Palo Alto, CA (US)

DESCRIPTION

(73) Assignee: **GOOGLE LLC**, Mountain View, CA (US)

FIG. 1 is a perspective view of a robot according to our new design, showing a first condition of use in which three sections of the robot are shown stacked and rotationally aligned with each other;

(**) Term: **15 Years**

FIG. 2 is a front view thereof;

(21) Appl. No.: **29/700,094**

FIG. 3 is a rear view thereof;

(22) Filed: **Jul. 31, 2019**

FIG. 4 is a left side view thereof;

(51) **LOC (13) Cl. 15-99**

FIG. 5 is a right side view thereof;

(52) **U.S. Cl.**

FIG. 6 is a top plan view thereof;

USPC **D15/199**

FIG. 7 is a bottom plan view thereof;

(58) **Field of Classification Search**

USPC D14/172, 216, 357, 358, 496; D15/199;

FIG. 8 is a perspective view of the robot, now showing a second condition of use in which a top section of the robot is elevated and in which the top and central section of the robot are each rotated counterclockwise relative to the bottom section;

D21/578-583, 621, 622; D32/21;

D34/34

FIG. 9 is a front view thereof;

(Continued)

FIG. 10 is a rear view thereof;

(56) **References Cited**

U.S. PATENT DOCUMENTS

717,703 A * 1/1903 McCarty A47C 27/001

5/722

1,976,320 A * 10/1934 Austin B61D 31/00

297/62

FIG. 11 is a left side view thereof;

FIG. 12 is a right side view thereof;

FIG. 13 is a top plan view thereof;

FIG. 14 is a bottom plan view thereof;

FIG. 15 is a perspective view of the robot, now showing a third condition of use in which both the top and central sections of the robot are further elevated and in which the top and central section of the robot are each further rotated counterclockwise relative to the bottom section, all as compared to FIG. 8;

FIG. 16 is a front view thereof;

FIG. 17 is a rear view thereof;

FIG. 18 is a left side view thereof;

FIG. 19 is a right side view thereof;

FIG. 20 is a top plan view thereof; and,

FIG. 21 is a bottom plan view thereof.

The process or period in which the robot transitions from one condition of use to another condition of use forms no part of the claimed design.

(Continued)

OTHER PUBLICATIONS

<https://allcitycandy.com/collections/bulk-gum/products/chiclets-3lb-4> (Year: 2018).*

(Continued)

Primary Examiner — Patricia A Palasik

(Continued)

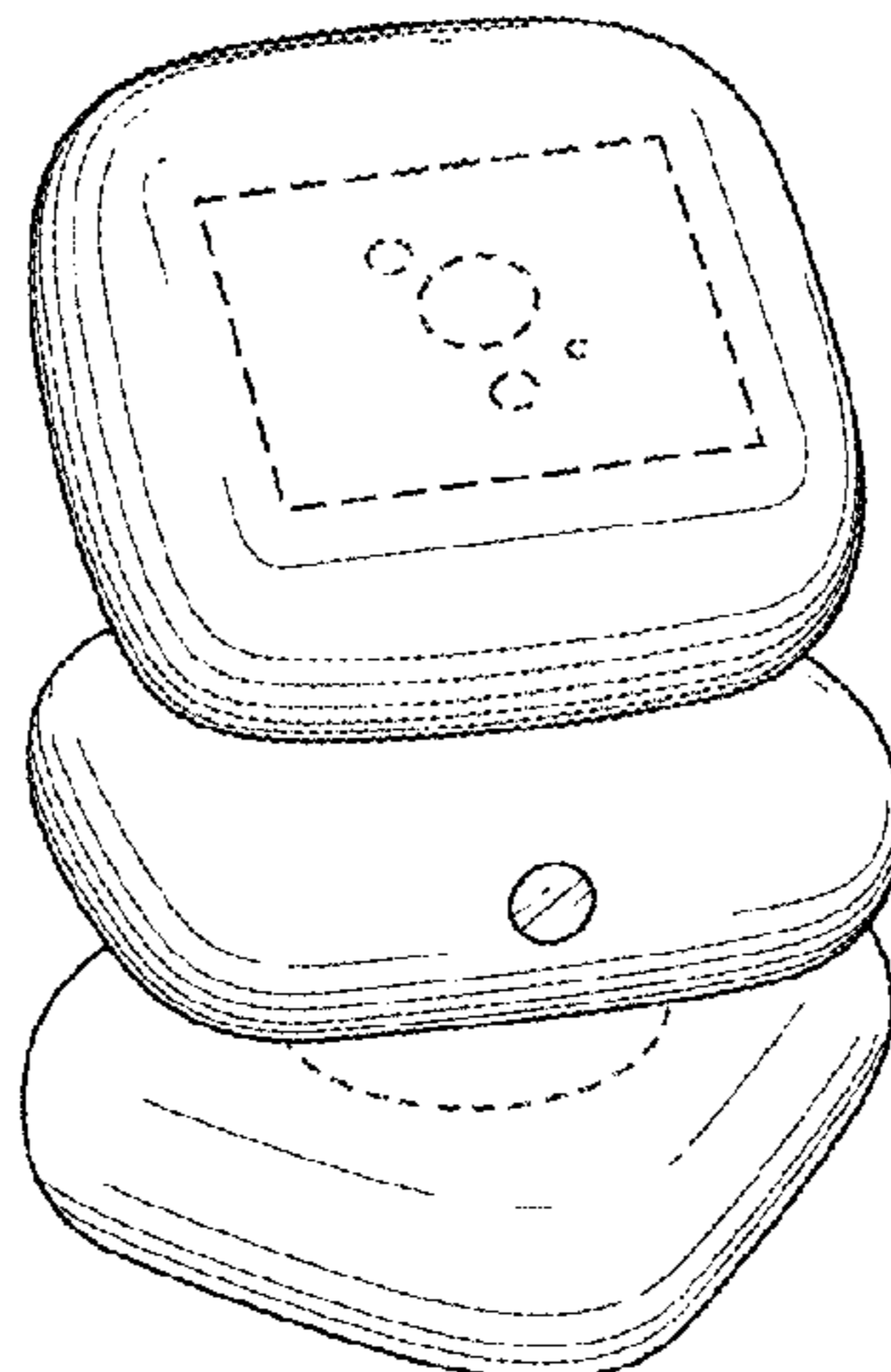

The broken-line showing of a display screen, hinge, and turntable are included for the purpose of illustrating portions of the robot and form no part of the claimed design.

1 Claim, 6 Drawing Sheets

(58) **Field of Classification Search**

CPC B25J 5/007; B25J 11/008; B60B 19/006; B62D 57/024; Y10S 901/01
See application file for complete search history.

(56) **References Cited**

U.S. PATENT DOCUMENTS

2,192,472 A * 3/1940 Huston B65D 75/20
426/115
2,536,168 A * 1/1951 Goggin A61K 9/0058
424/440
2,547,840 A * 4/1951 Smith A47C 27/001
5/722
D193,138 S * 7/1962 Ohlsson D6/379
3,308,489 A * 3/1967 Winkler A47C 27/10
5/648
3,336,610 A * 8/1967 Arthur A47D 15/00
5/420
3,572,836 A * 3/1971 Khanh A47C 4/54
297/452.41
D229,994 S * 1/1974 Thompson D6/372
D229,995 S * 1/1974 Niemeyer D6/367
3,902,759 A * 9/1975 Monteforte A47C 17/045
297/452.16
D278,582 S * 4/1985 Kramer D6/373
4,518,203 A * 5/1985 White A47C 17/045
297/108
D288,634 S * 3/1987 Williams D6/334
D298,788 S * 12/1988 Thompson D6/334
D300,884 S * 5/1989 Friedman D6/349
5,086,529 A * 2/1992 DeGroot A47C 27/001
5/710
D328,823 S * 8/1992 Rogers, Jr. D6/367
D336,376 S * 6/1993 Hollington D6/334
D348,792 S * 7/1994 DeGroot D6/604
D350,240 S * 9/1994 Carstarphen D6/361
D366,383 S * 1/1996 Briegleb D6/601
5,491,851 A * 2/1996 Alonso A47C 27/001
5/420
5,506,012 A * 4/1996 Wright B66F 3/35
254/93 HP
5,867,849 A * 2/1999 Pontrello A47C 5/125
5/2.1
6,042,186 A * 3/2000 Kojic A47C 4/54
297/452.41
D477,104 S * 7/2003 Wang D26/72
6,886,204 B2 * 5/2005 Kasatshko A47C 4/54
297/452.41
7,036,162 B1 * 5/2006 Gatten A47C 21/04
5/420
D672,182 S * 12/2012 Mischak D6/601
D685,211 S * 7/2013 Vega-Woller D6/596
D749,570 S * 2/2016 Lee D14/344
D807,665 S * 1/2018 Vega-Woller D6/596

D831,990 S * 10/2018 Lu D6/349
10,264,888 B2 * 4/2019 Clark A47C 7/021
D856,429 S * 8/2019 Hwang D20/10
D863,797 S * 10/2019 Qu D6/349
D907,399 S * 1/2021 Pavlin D6/601
D925,588 S * 7/2021 Matsui D14/488
D925,589 S * 7/2021 Matsui D14/488
D925,590 S * 7/2021 Matsui D14/488
D925,591 S * 7/2021 Matsui D14/488
D925,592 S * 7/2021 Matsui D14/488
2003/0080021 A1 * 5/2003 Kopecky B65D 77/04
206/531
2003/0192121 A1 * 10/2003 Fleming A47C 31/007
5/420
2007/0048414 A1 * 3/2007 Glydon B65D 5/38
426/120
2007/0122521 A1 * 5/2007 Degady A23G 4/00
426/5
2008/0028529 A1 * 2/2008 Abell A47G 9/0253
5/640
2009/0202673 A1 * 8/2009 Phillips A23G 4/20
426/5
2010/0068339 A1 * 3/2010 Neergaard A23G 4/08
426/5
2013/0276238 A1 * 10/2013 Vega-Woller A47D 15/003
5/703
2013/0306511 A1 * 11/2013 Branyon B65D 75/327
53/412
2014/0000634 A1 * 1/2014 Mishra A24B 13/00
131/355
2014/0130814 A1 * 5/2014 Gao A24B 15/16
131/359
2014/0130818 A1 * 5/2014 Carroll A24B 13/00
131/352
2014/0261504 A1 * 9/2014 Griscik B29C 43/006
264/120
2015/0096577 A1 * 4/2015 Gao A24B 15/16
131/290
2015/0098909 A1 * 4/2015 Gao A23G 3/38
514/217
2016/0021909 A1 * 1/2016 Brown A23G 4/02
426/5
2016/0081500 A1 * 3/2016 Bradshaw A47G 9/10
5/640
2017/0210530 A1 * 7/2017 Lyzenga B65B 61/007
2020/0069581 A1 * 3/2020 Ghalili A61K 36/185

OTHER PUBLICATIONS

<https://nuts.com/chocolatessweets/bubble-gum/chiclets/1lb.html> (Year: 2015).*
https://www.amazon.com/Canels-Gum-Box-Original-Count/dp/B007RYDBVW/ref=asc_df_B007RYDBVW/?tag=hyprod-20&linkCode=df0&hvadid=312193679191 &hvpos=&hvnetw=g&hvrnd=16625825000532520999&hvpone=&hvptwo=&hvqmt=&hvdev=c&hvdvcmdl=&hvlocint=&hvlocphy=9059726&hvtargid=pla-572033129217&pvc=1 (Year: 2012).*
<https://gameforge.com/en-US/littlegames/stack-blocks-3d/> (Year: 2022).*
<https://www.sweetasfudge.com/product/chiclet-assorted-gum/> (Year: 2022).*

* cited by examiner

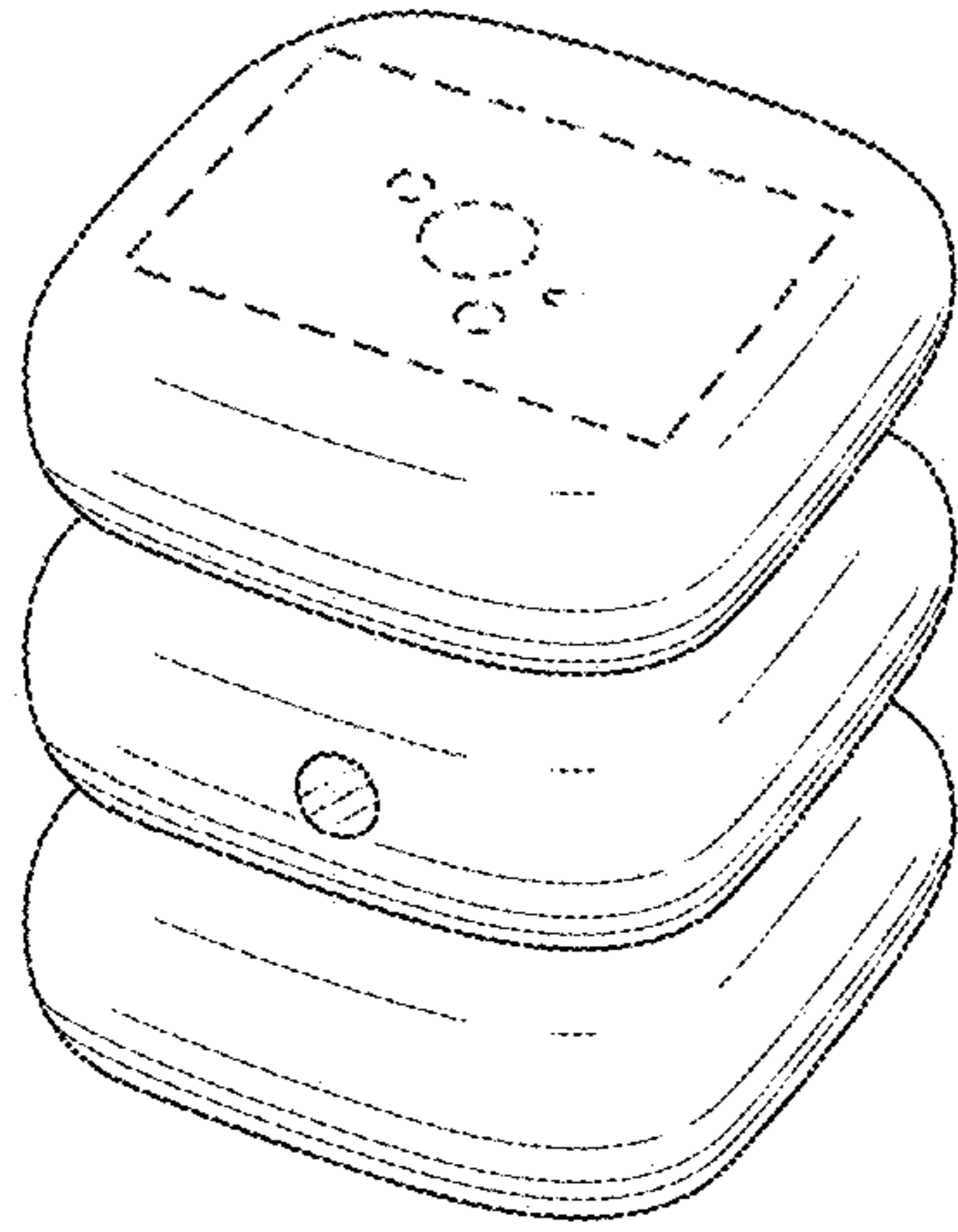

Fig. 1

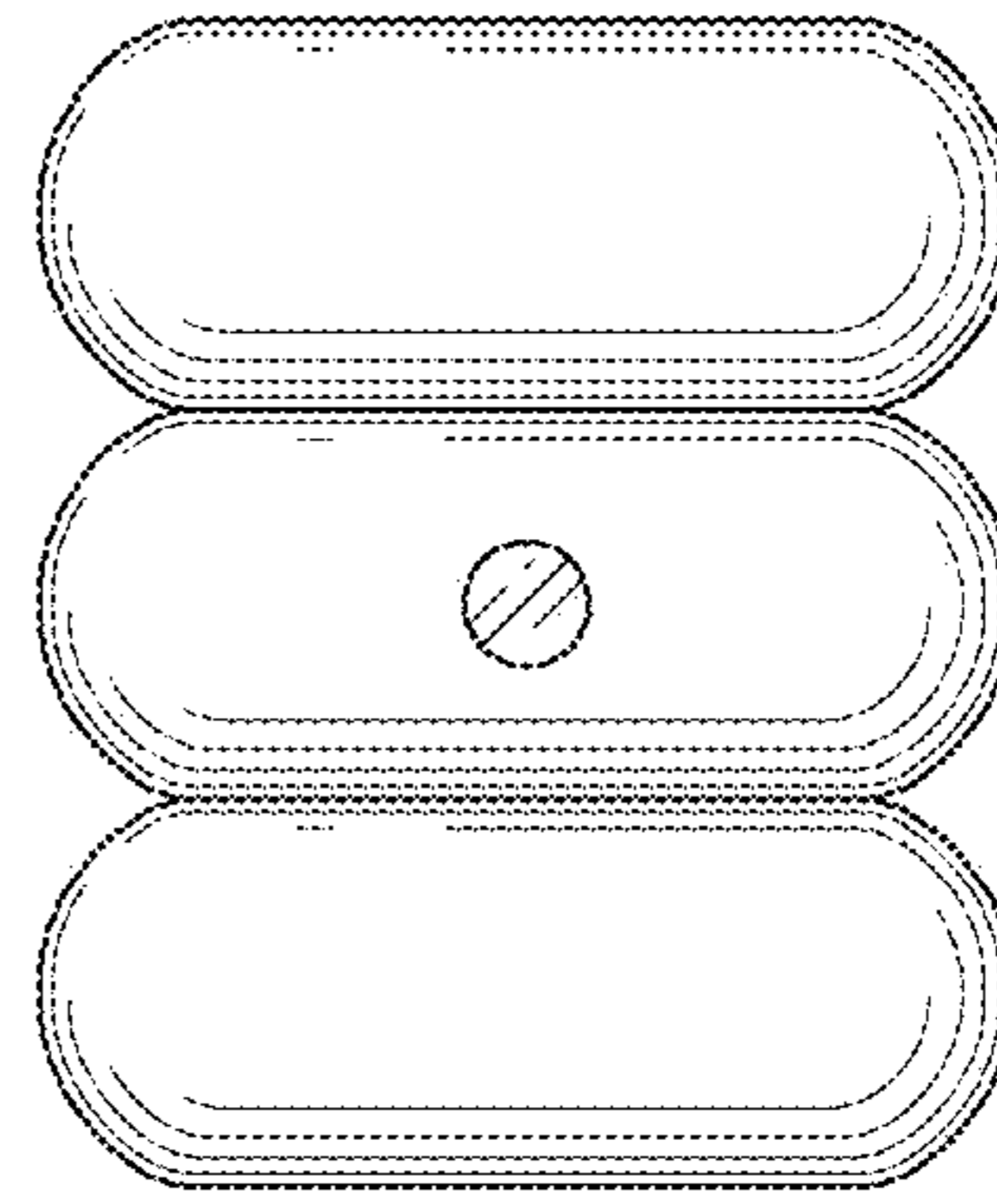

Fig. 2

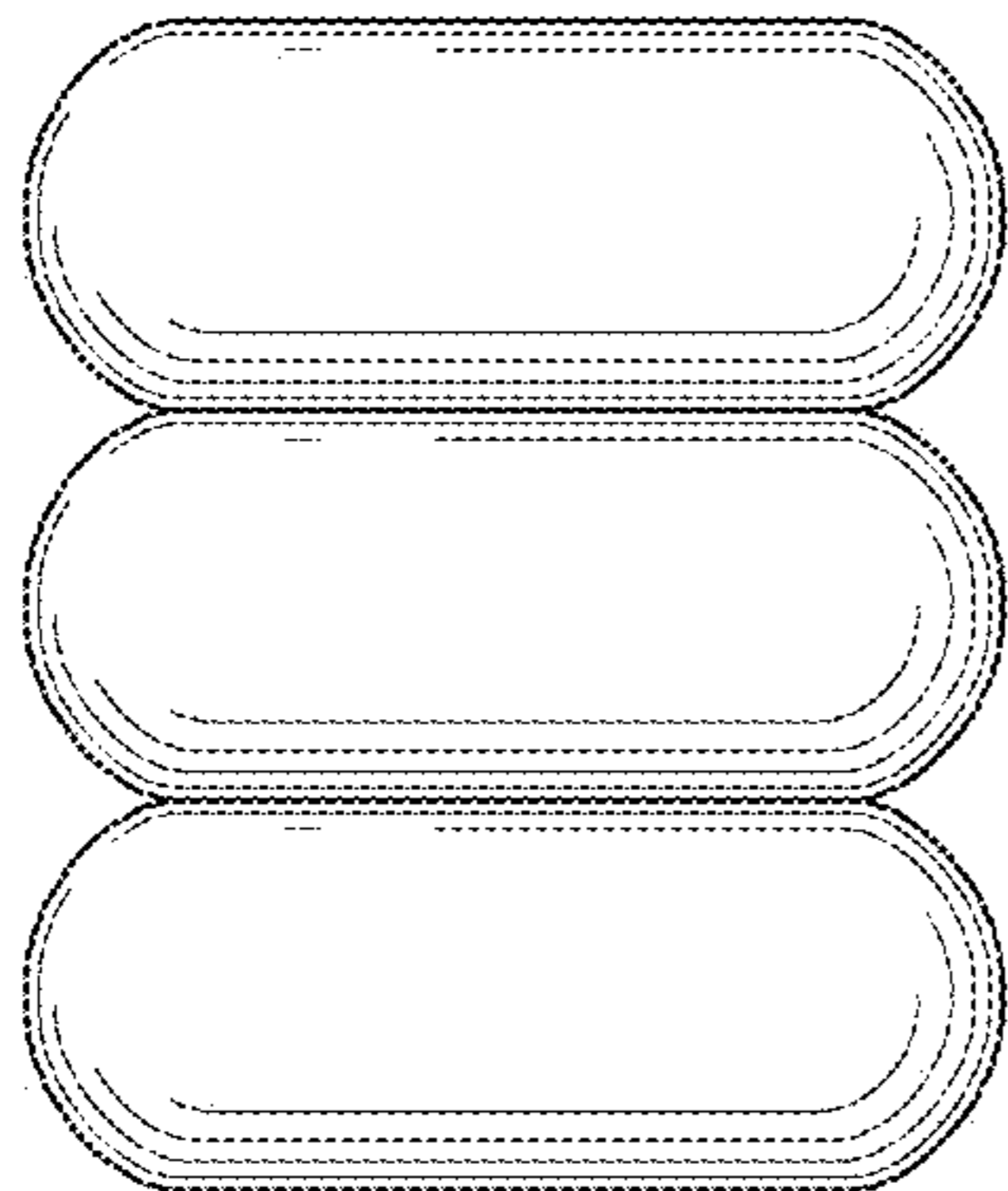

Fig. 3

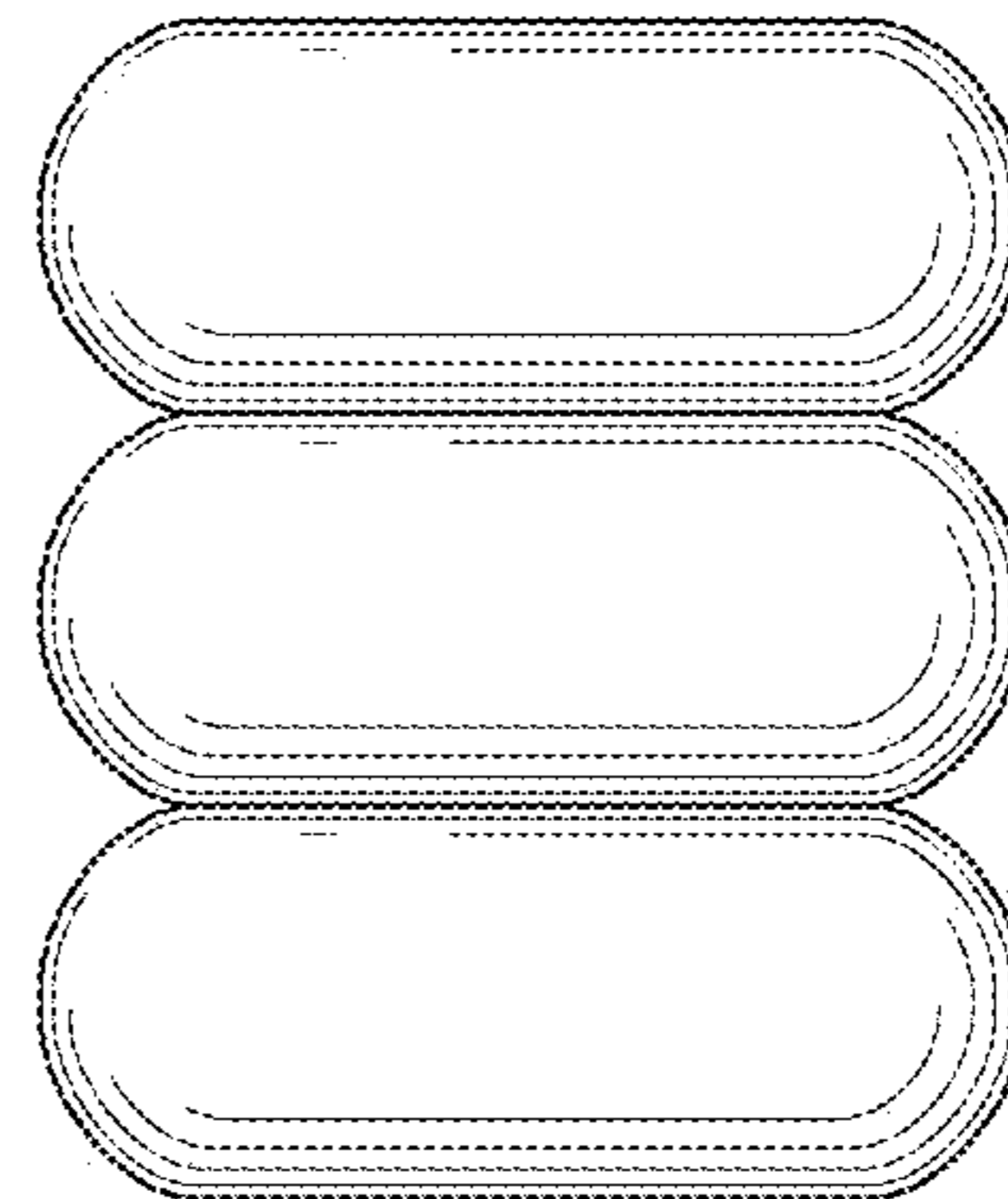

Fig. 4

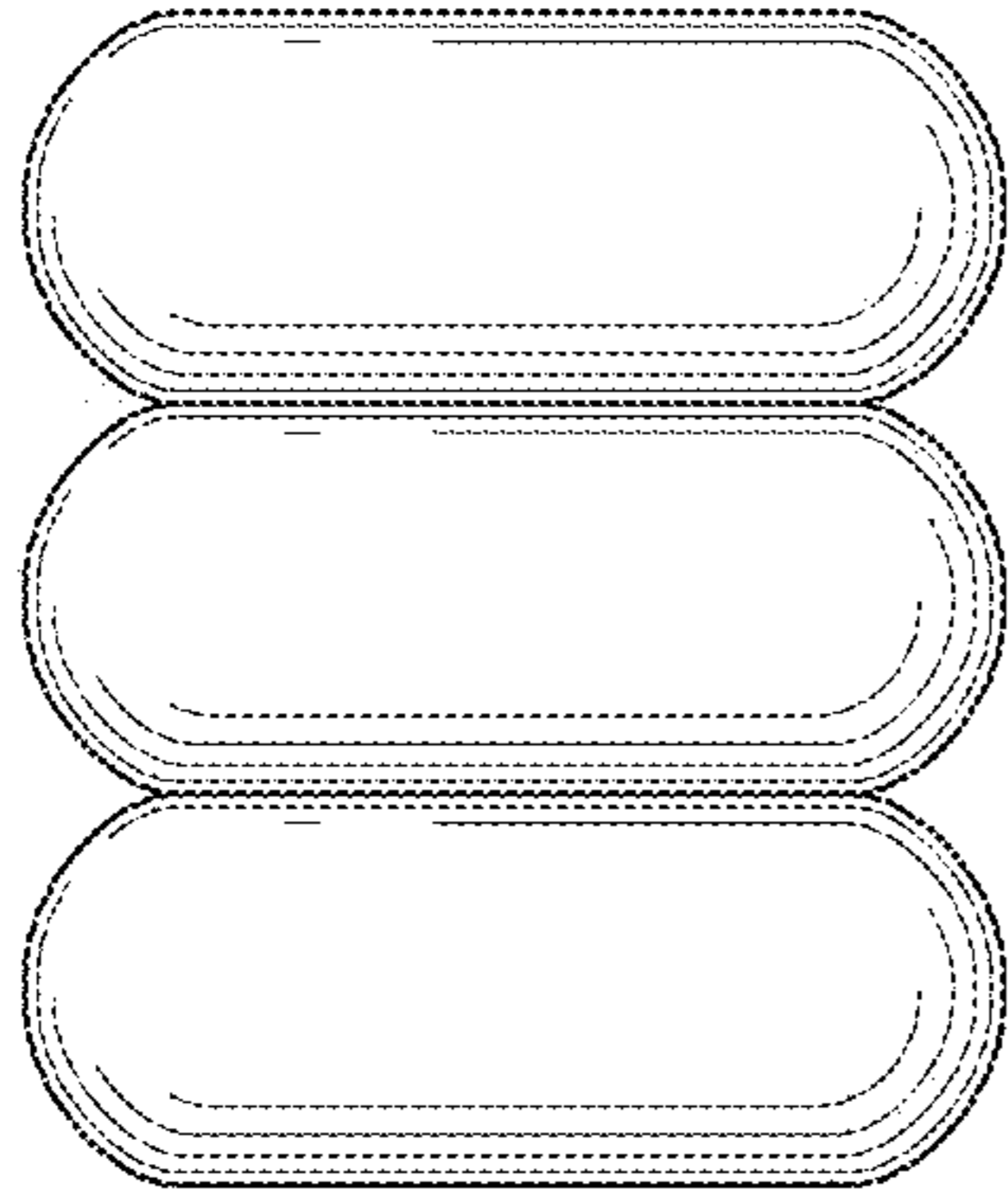

Fig. 5

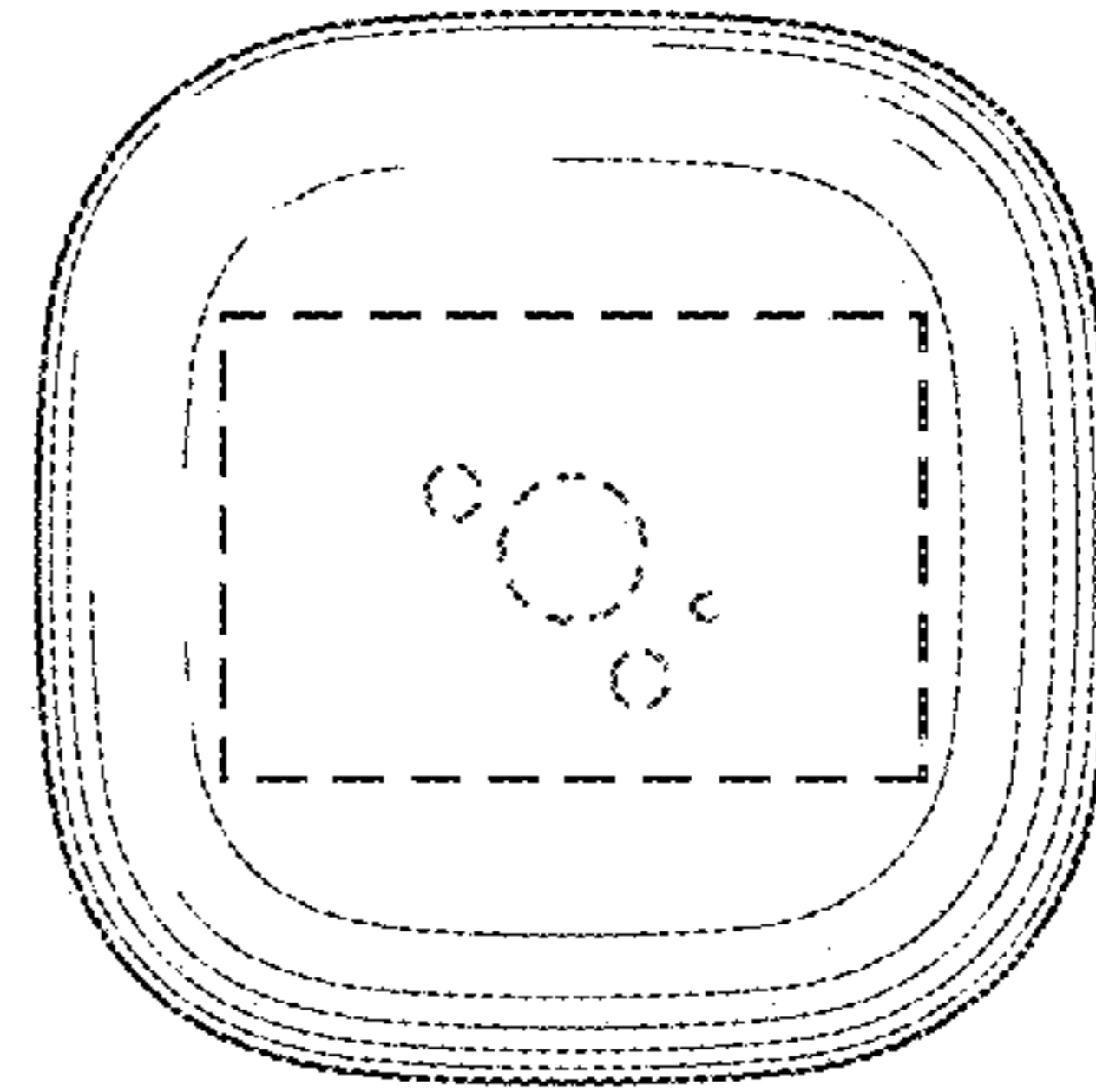

Fig. 6

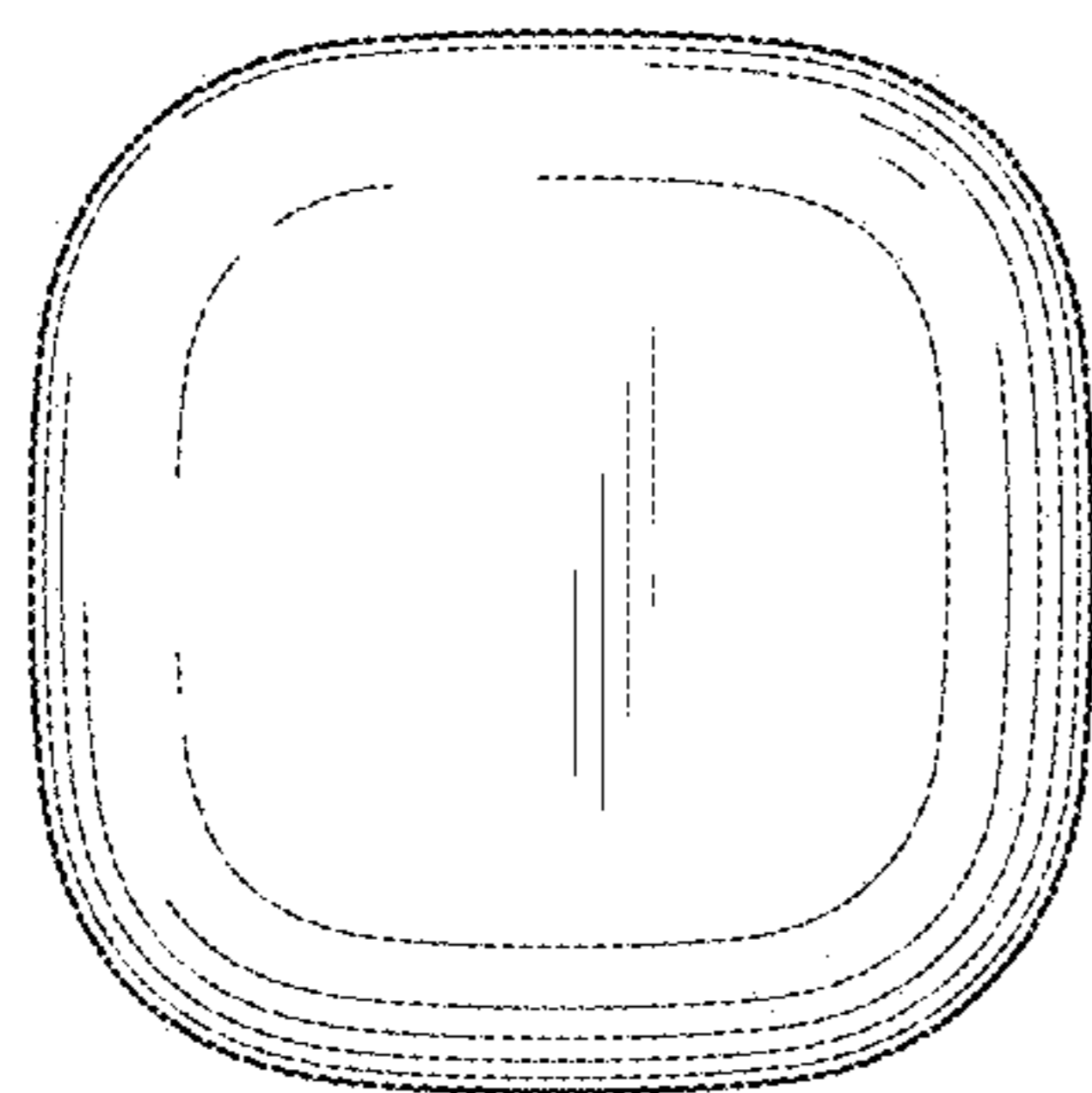

Fig. 7

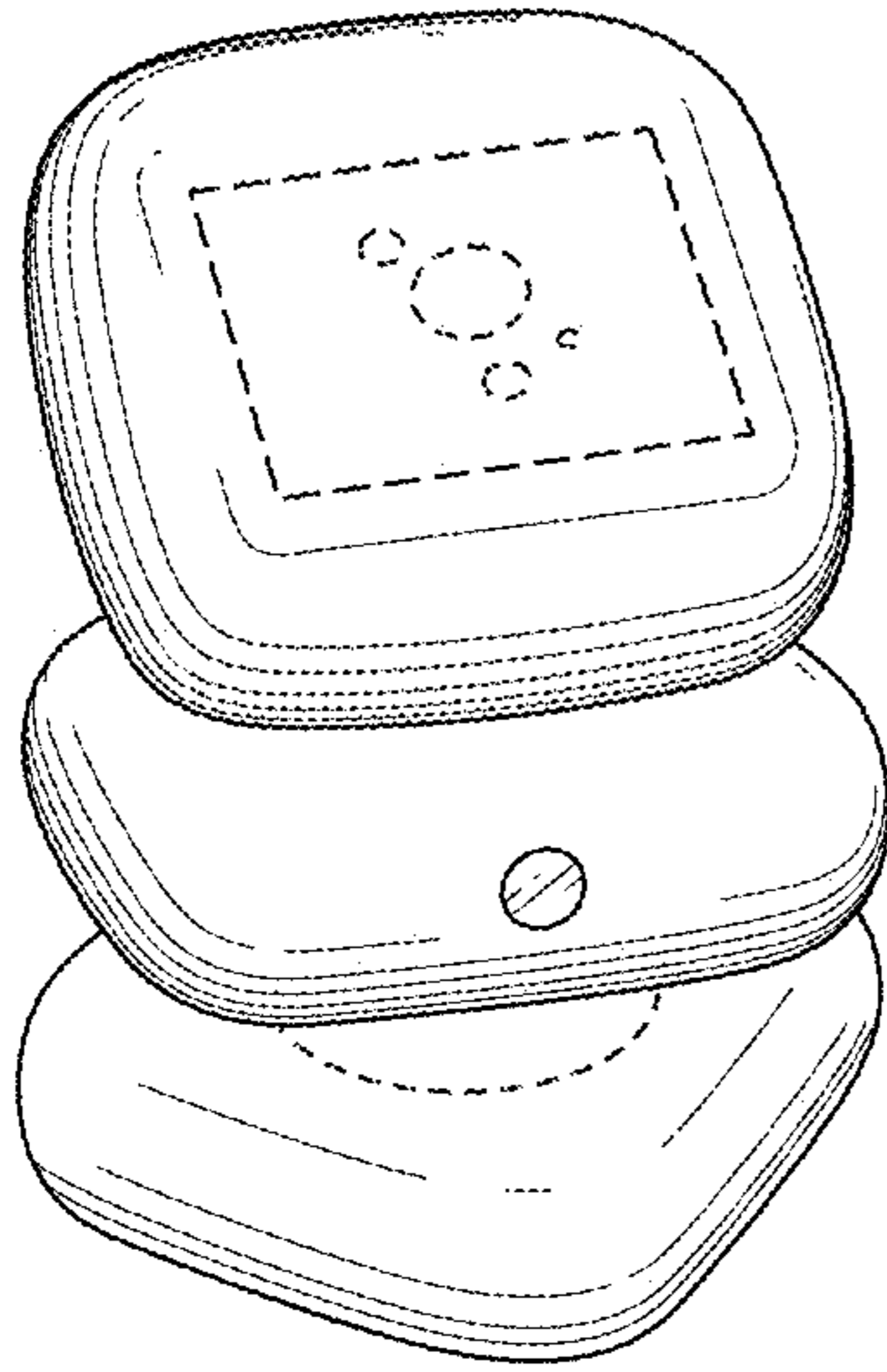

Fig. 8

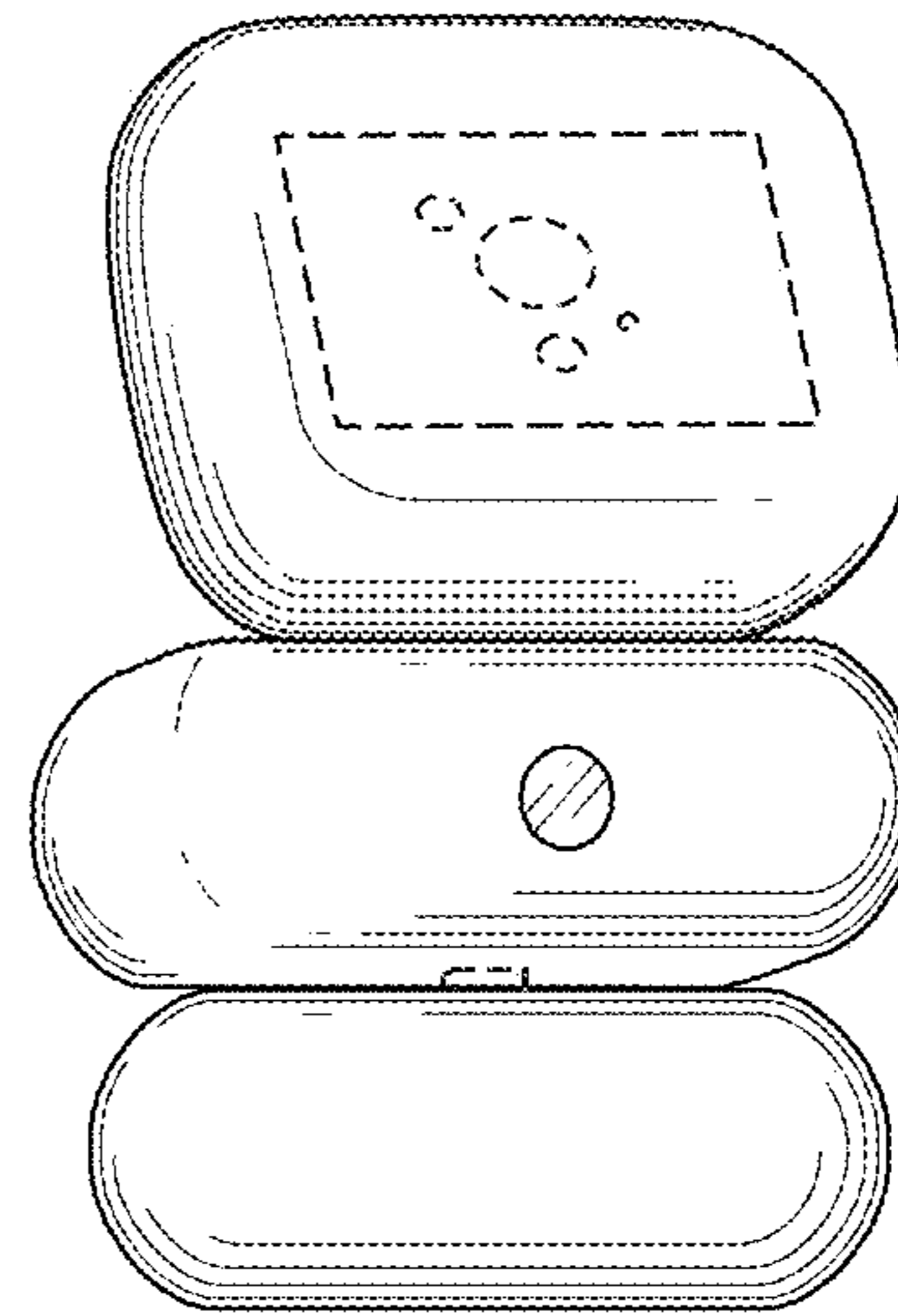

Fig. 9

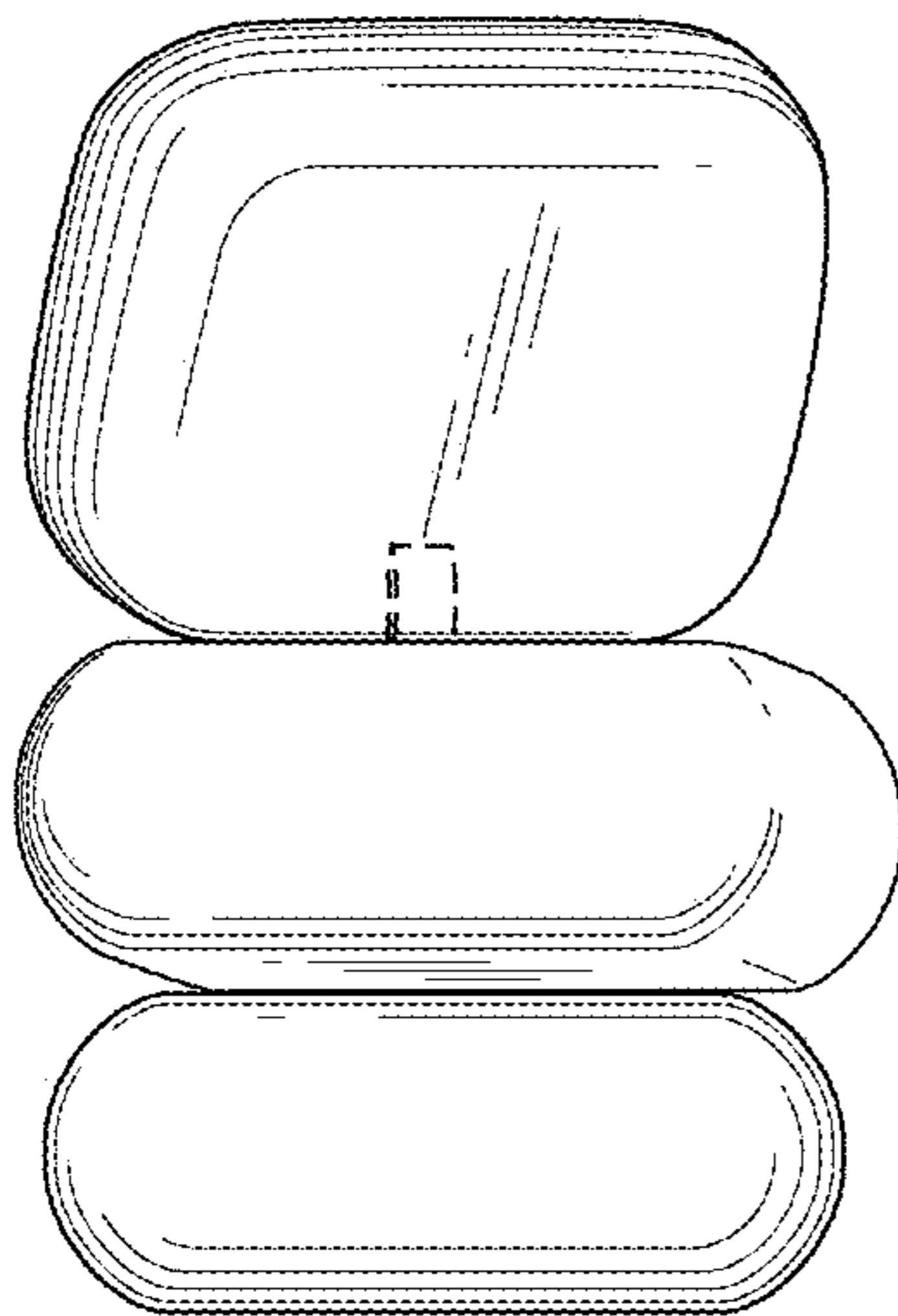

Fig. 10

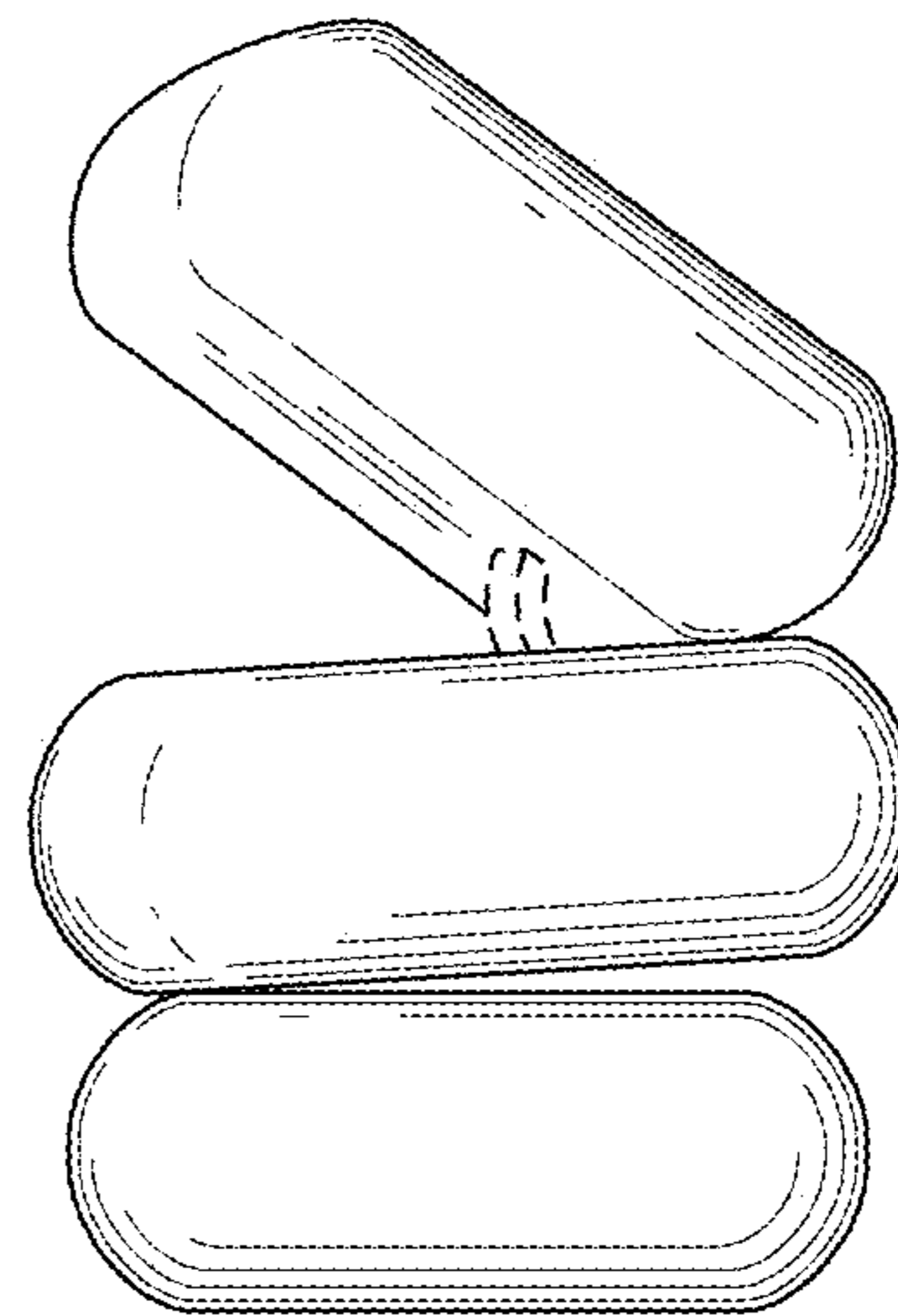

Fig. 11

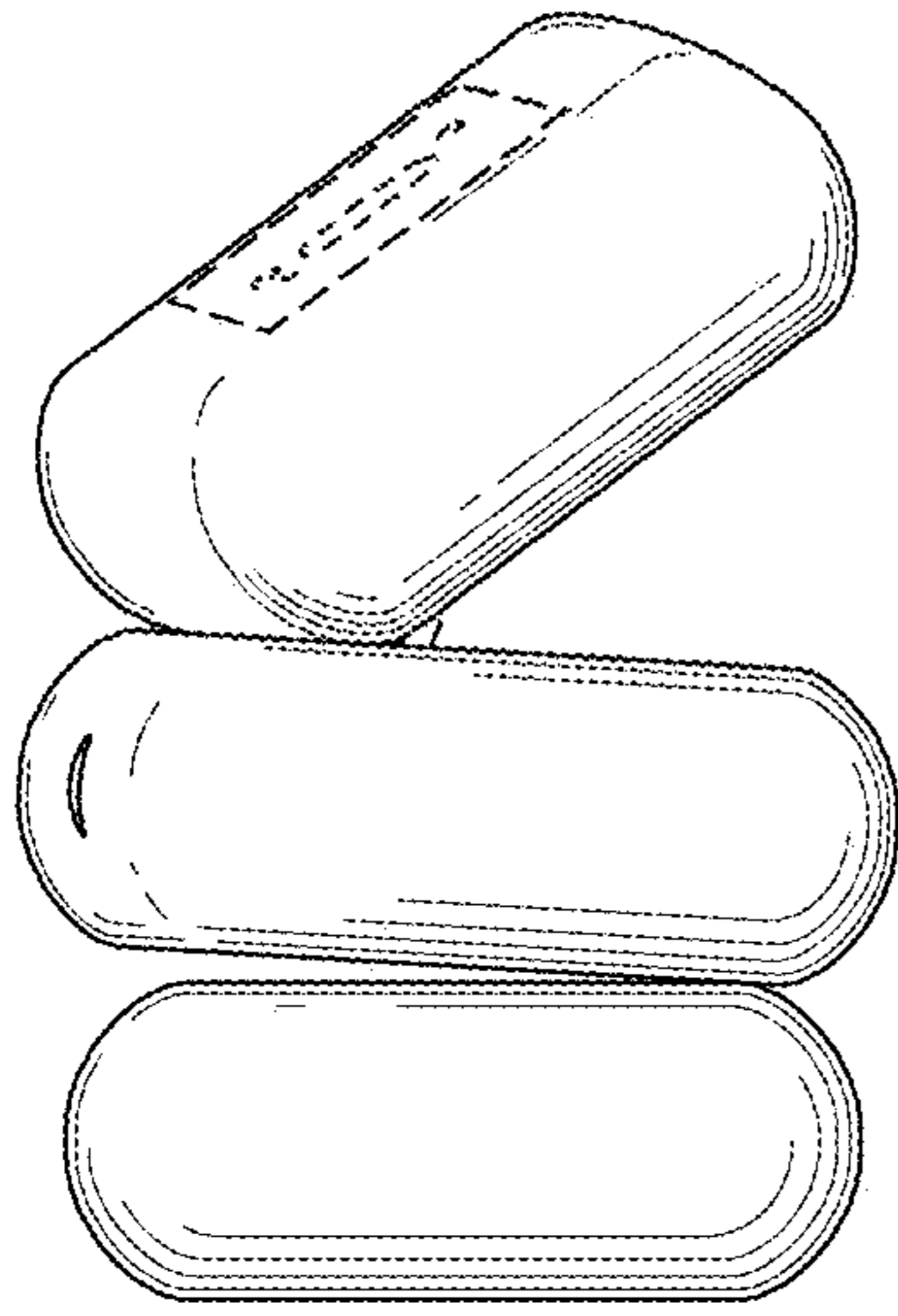

Fig. 12

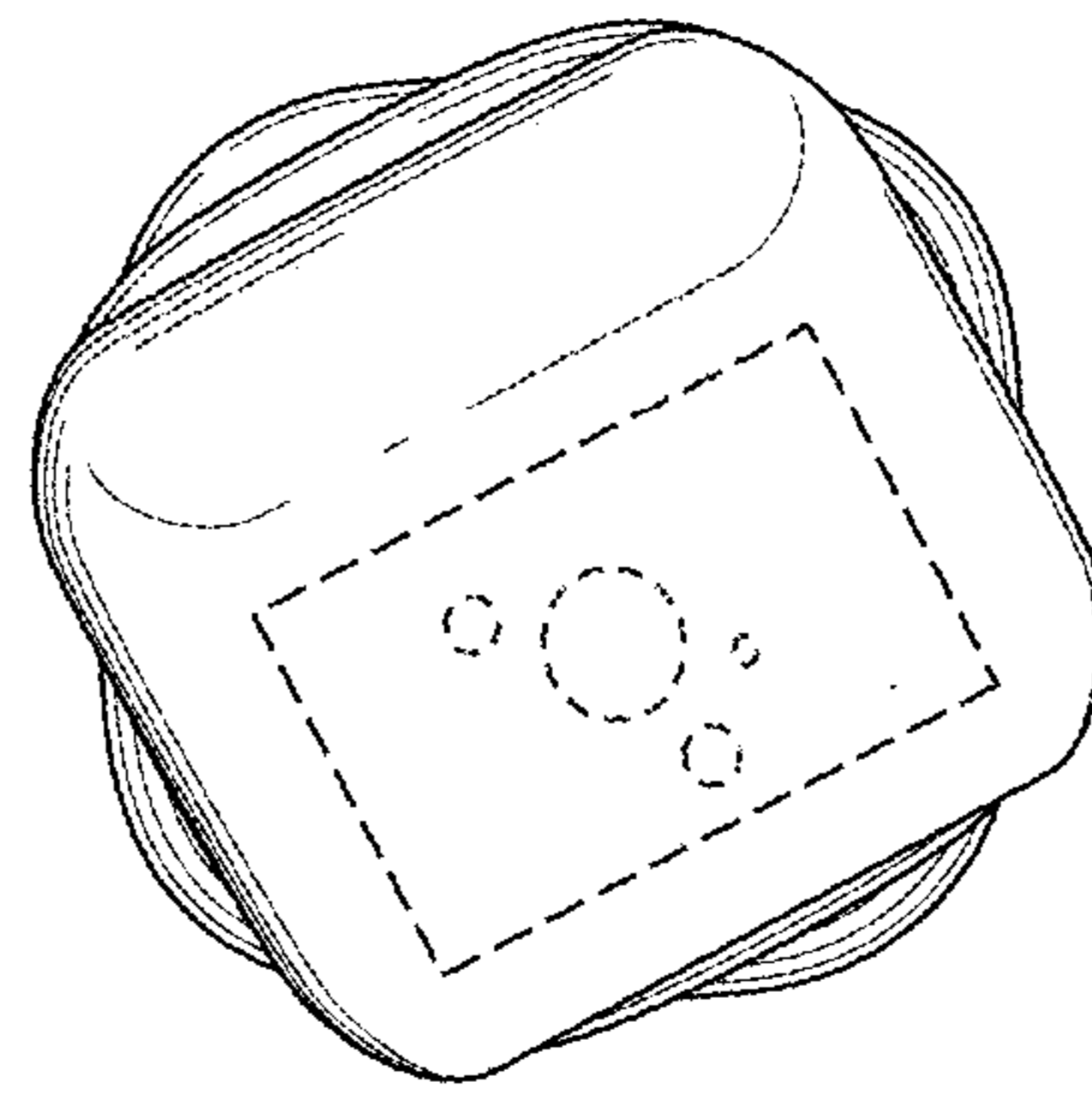

Fig. 13

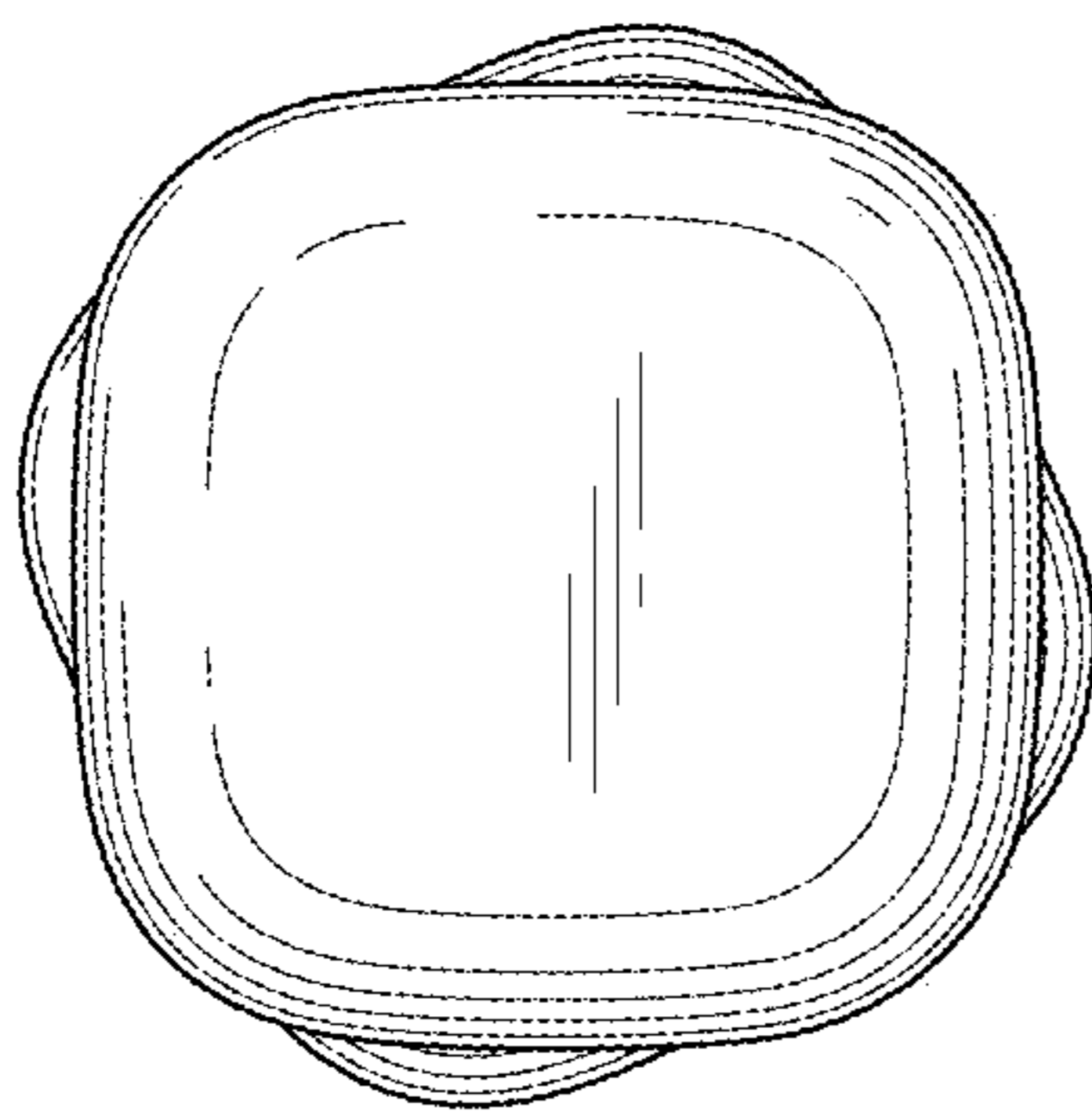

Fig. 14

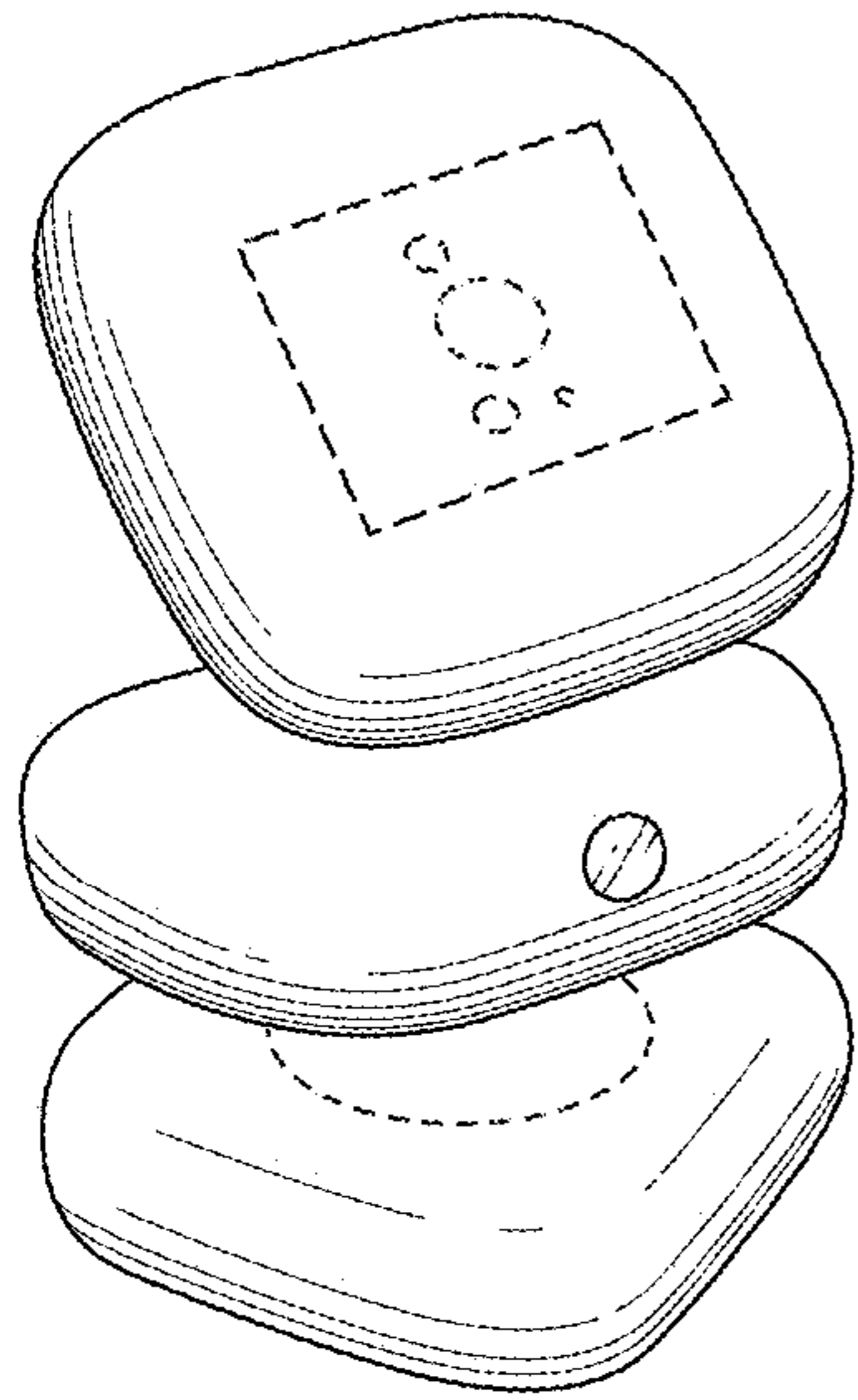

Fig. 15

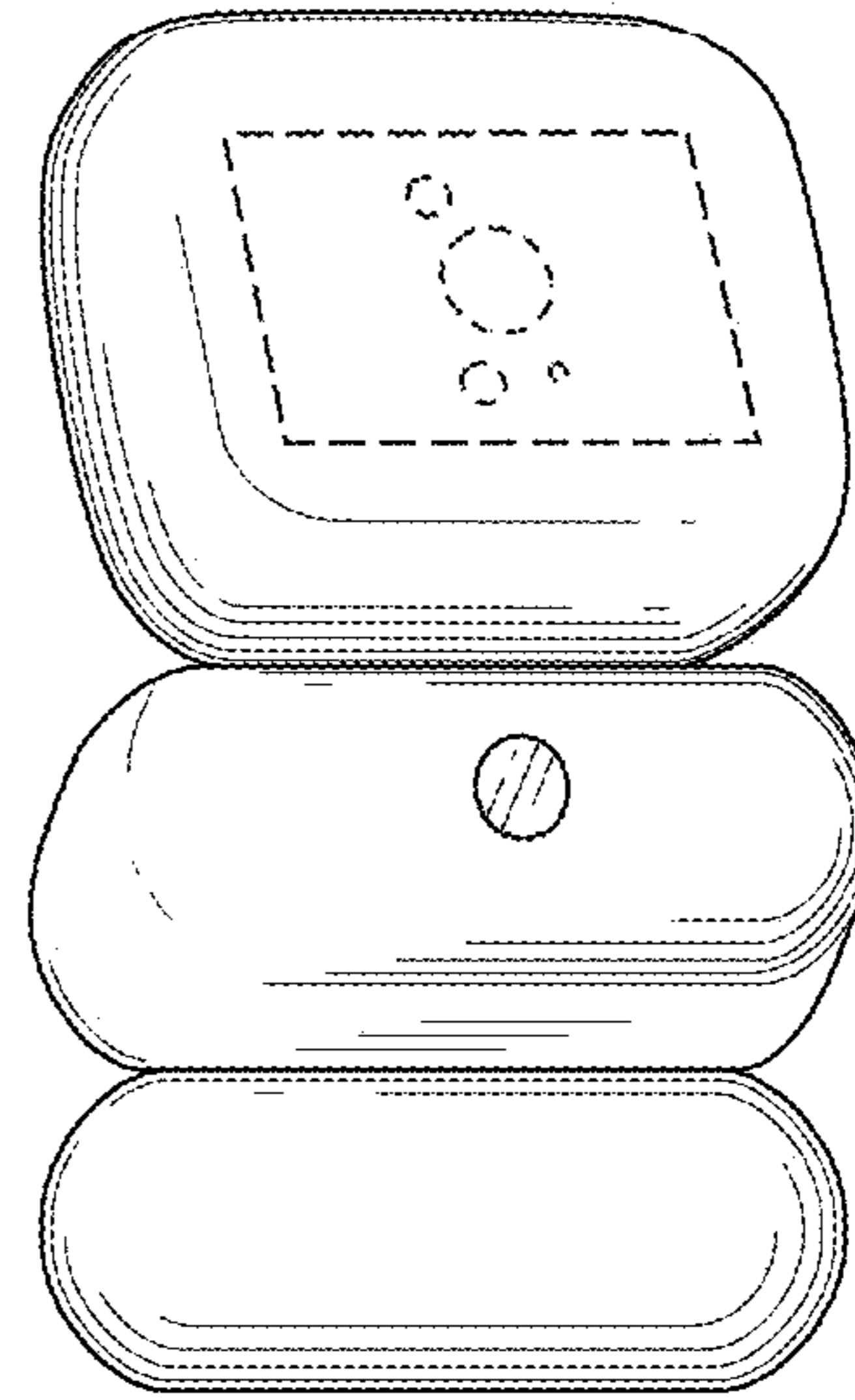

Fig. 16

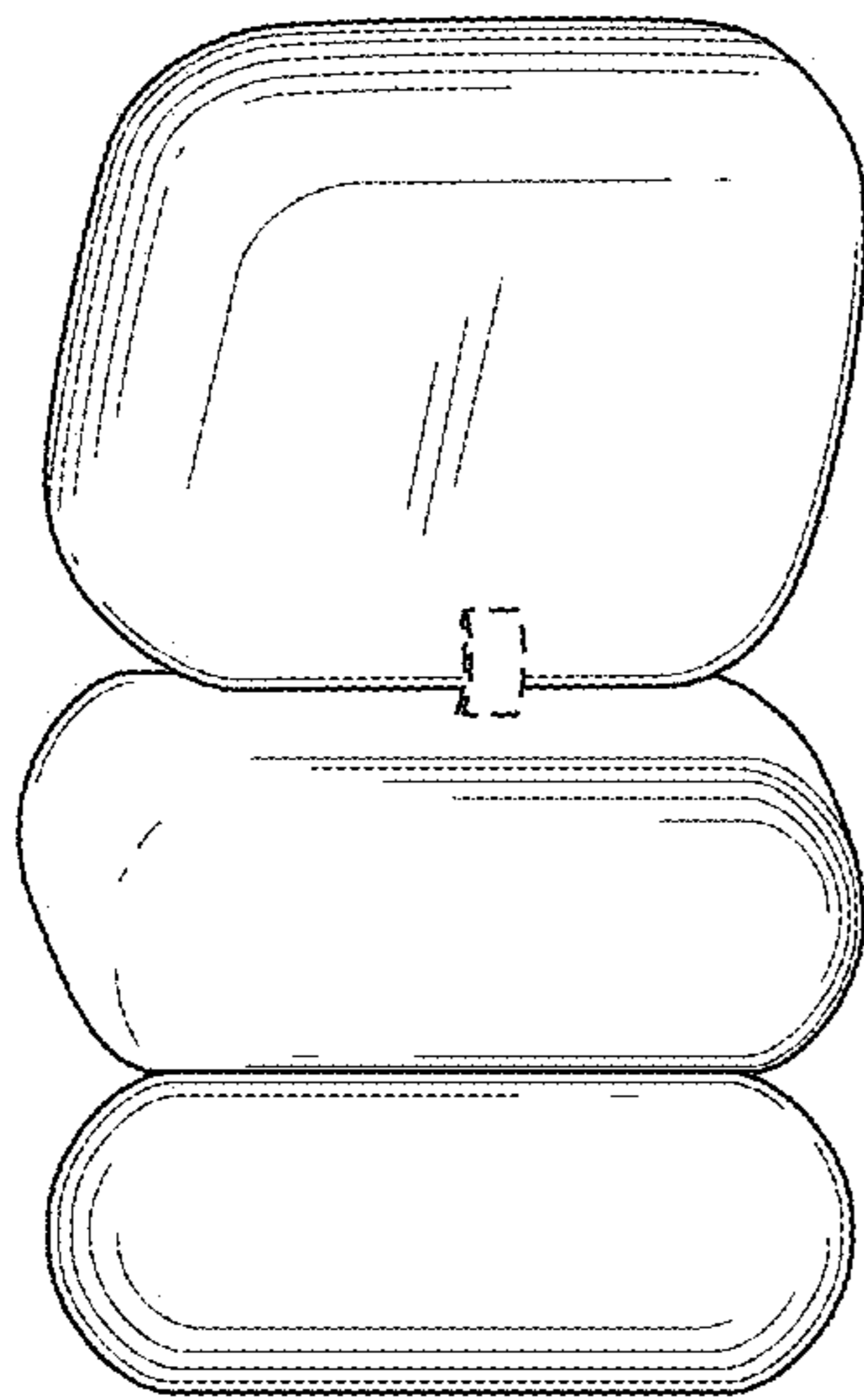

Fig. 17

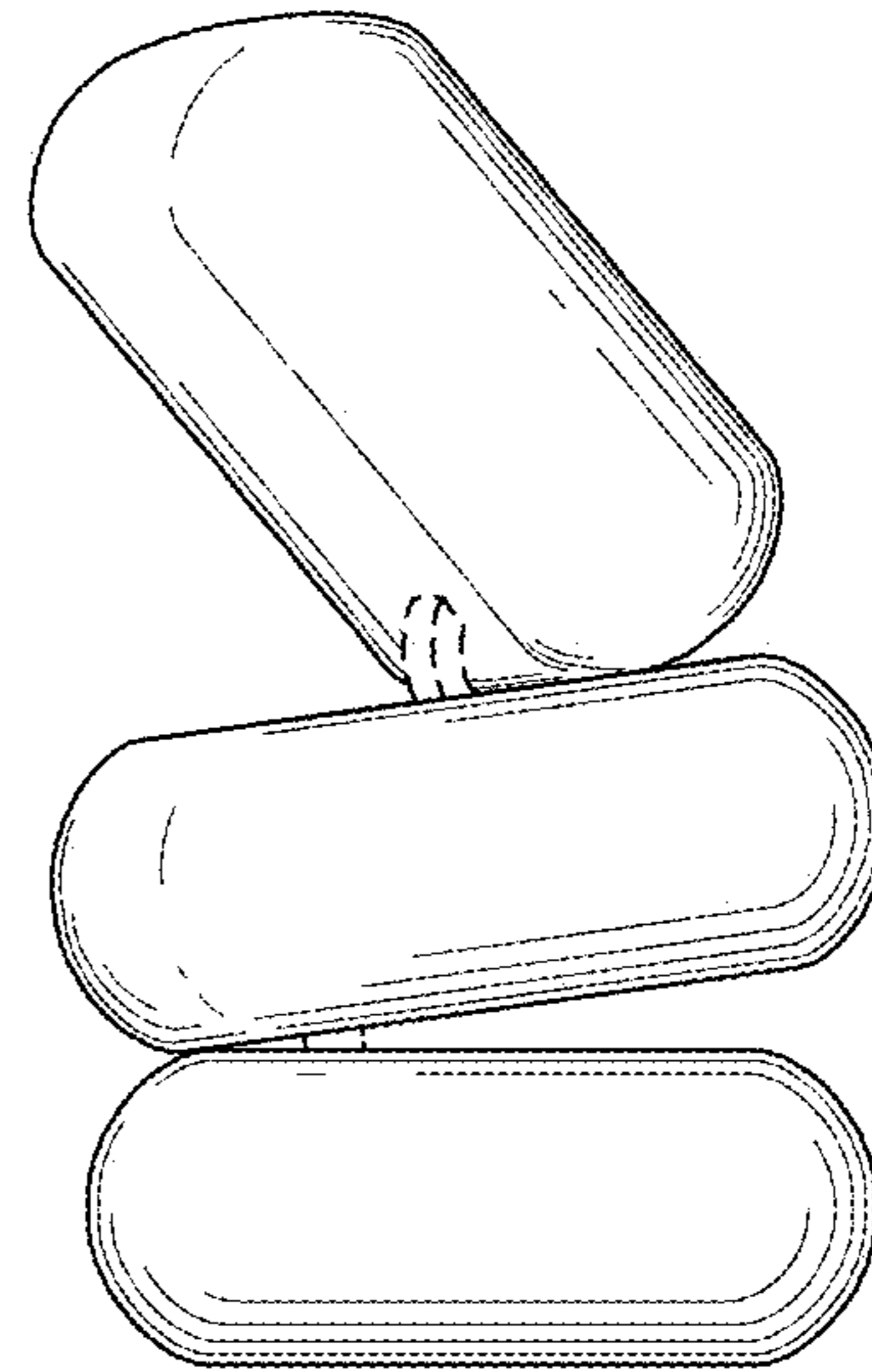

Fig. 18

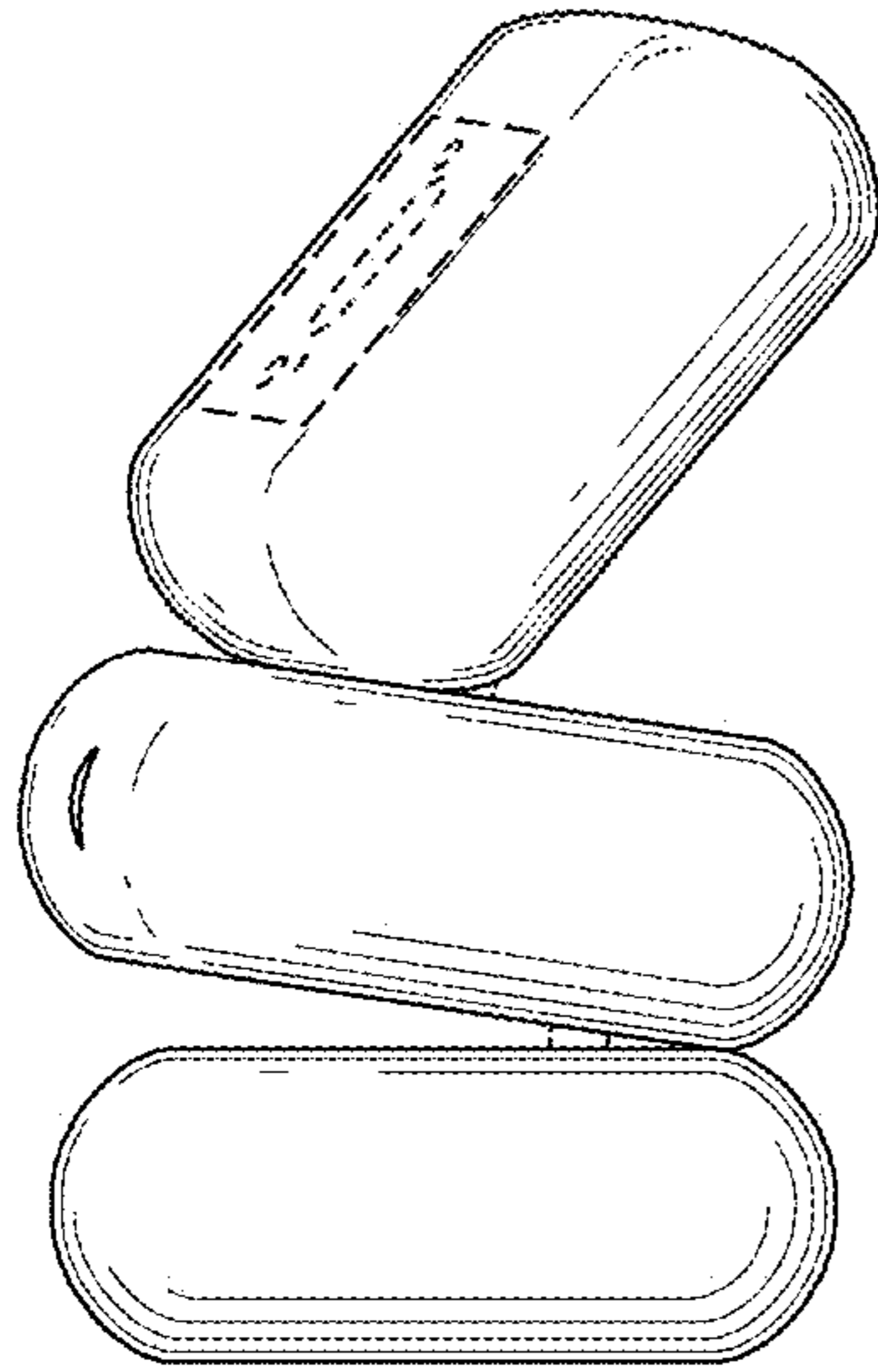

Fig. 19

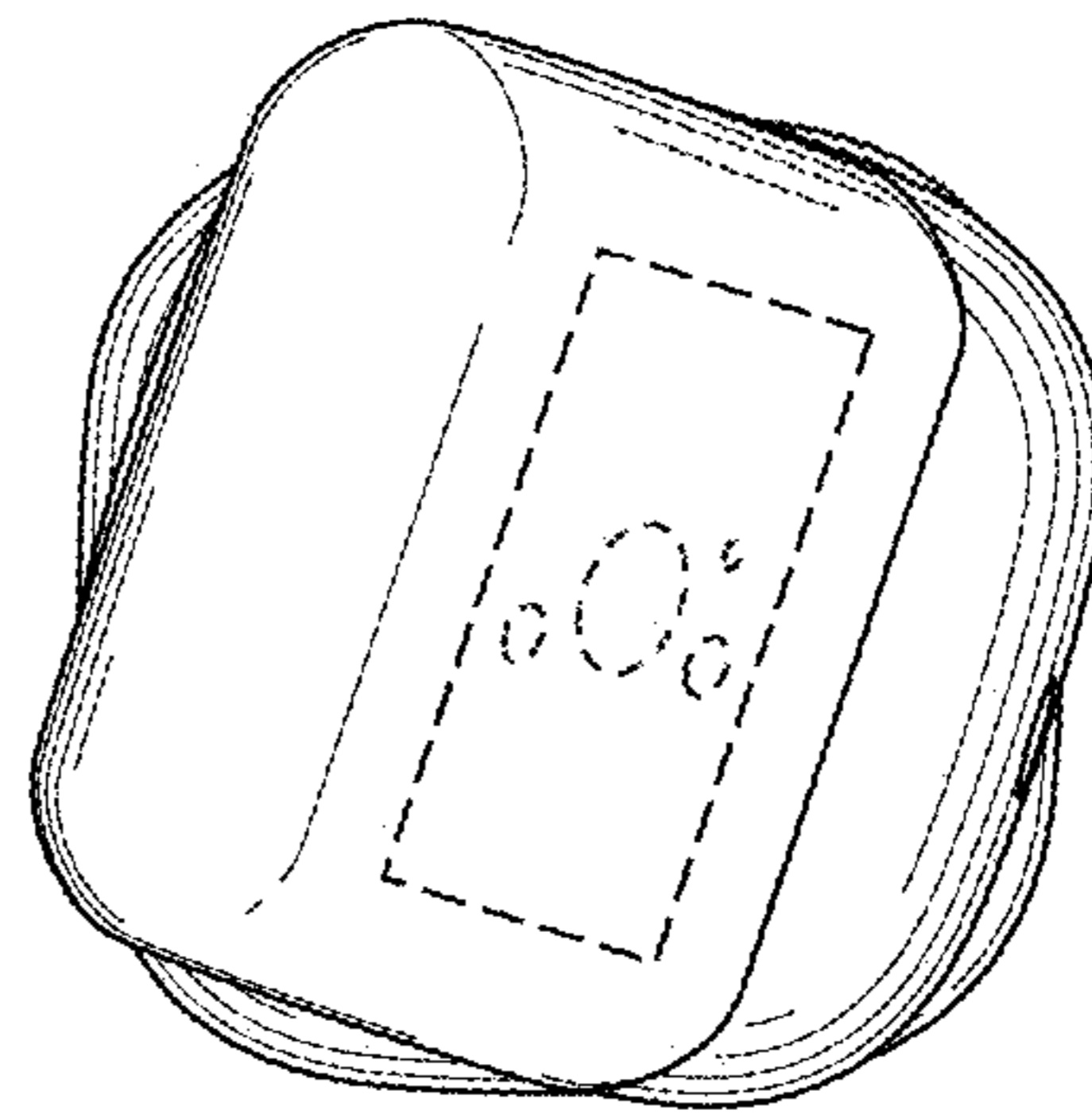

Fig. 20

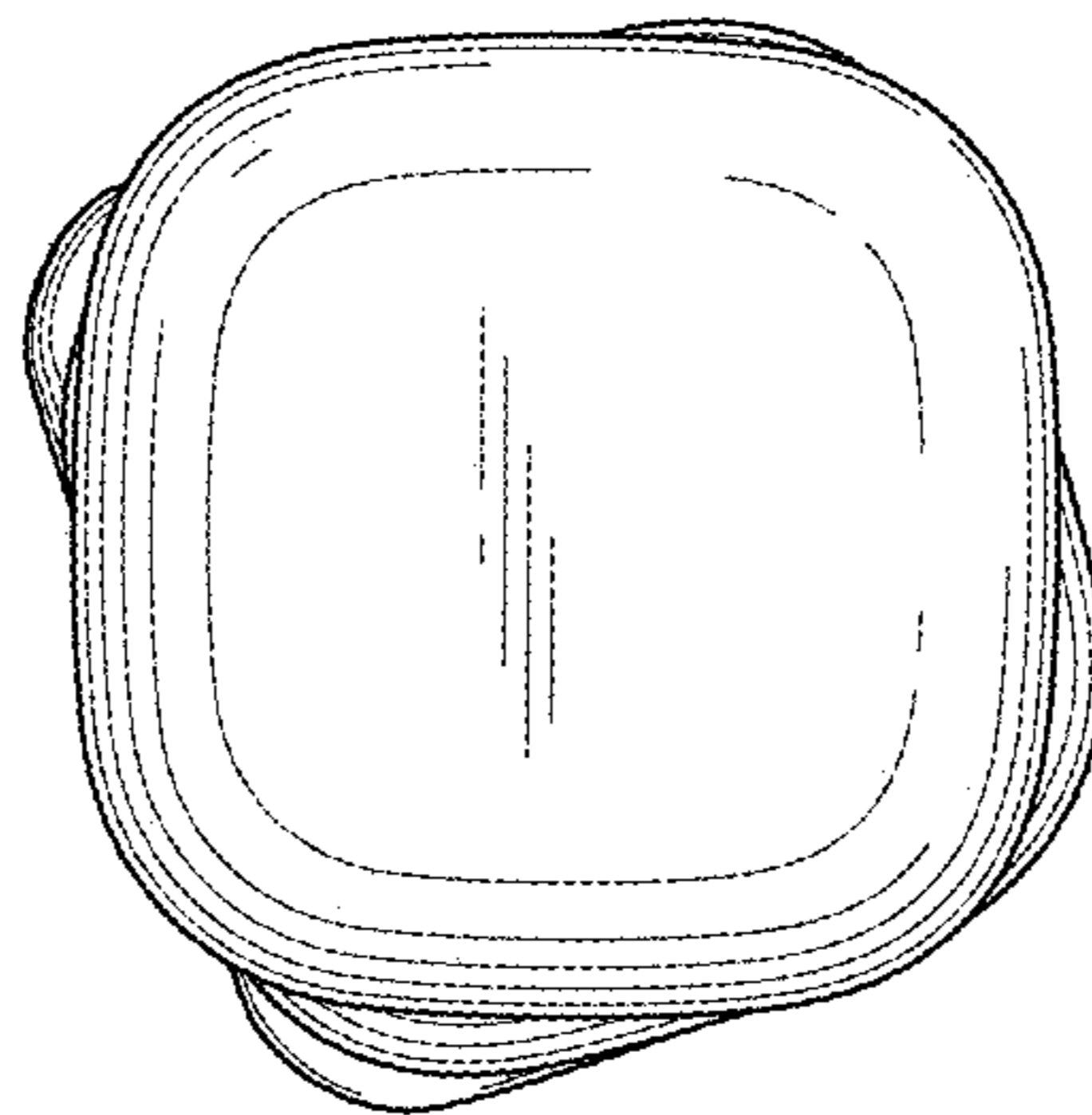

Fig. 21