



US00D955347S

(12) **United States Design Patent**  
**Shi**

(10) **Patent No.:** **US D955,347 S**

(45) **Date of Patent:** **\*\* Jun. 21, 2022**

(54) **MASSAGER CONTROLLER**  
(71) Applicant: **Shenzhen Sinopine Technology Co., Ltd.**, Shenzhen (CN)  
(72) Inventor: **Huifang Shi**, Shenzhen (CN)  
(73) Assignee: **Shenzhen Sinopine Technology Co., Ltd.**, Shenzhen (CN)

D870,057 S \* 12/2019 Gassner ..... D13/168  
D891,380 S 7/2020 Li  
D909,994 S \* 2/2021 Bristol ..... D14/218  
D938,940 S \* 12/2021 Park ..... D14/218  
D948,479 S \* 4/2022 Reichert ..... D14/218  
2004/0108192 A1\* 6/2004 Schneider ..... H01H 25/041  
200/296  
2004/0129543 A1\* 7/2004 Voltz ..... B64D 11/00155  
200/200

(Continued)

(\*\*) Term: **15 Years**

**OTHER PUBLICATIONS**

(21) Appl. No.: **29/800,935**  
(22) Filed: **Jul. 25, 2021**  
(51) **LOC (13) Cl.** ..... **14-03**  
(52) **U.S. Cl.**  
USPC ..... **D13/168**  
(58) **Field of Classification Search**  
USPC ..... D13/162, 168; D14/218  
CPC .... G07C 9/00944; G08C 17/00; G08C 17/02;  
H04B 1/202; H01H 9/02; H01H 9/0214;  
H01H 9/0235; H01H 9/0242  
See application file for complete search history.

Chair remote controller; retrieved May 4, 2022; 1 pg.;[https://www.bing.com/images/search?view=detailV2&ccid=5twGg6v5&id=3C1D59162345503F5ACD2787519C316F6B3A6C90&thid=OIP.5twGg6v5yG3wjdf2OZF1PwHaHa&mediaurl=https%3a%2f%2fh.bing.com%2fh%2fid%2fR.e6dc0683abf9c86df08dd7f63991753f%3frik%3dkGw6a28xnFGHJw%26riu%3dhttp%253.\\*](https://www.bing.com/images/search?view=detailV2&ccid=5twGg6v5&id=3C1D59162345503F5ACD2787519C316F6B3A6C90&thid=OIP.5twGg6v5yG3wjdf2OZF1PwHaHa&mediaurl=https%3a%2f%2fh.bing.com%2fh%2fid%2fR.e6dc0683abf9c86df08dd7f63991753f%3frik%3dkGw6a28xnFGHJw%26riu%3dhttp%253.*)

(Continued)

*Primary Examiner* — Selina Sikder  
(74) *Attorney, Agent, or Firm* — True Shepherd, LLC;  
Andrew Cheng

(56) **References Cited**

**U.S. PATENT DOCUMENTS**

D442,564 S \* 5/2001 Ohkuma ..... D13/168  
6,492,786 B1 \* 12/2002 Vang ..... A61G 5/14  
5/616  
D499,717 S \* 12/2004 Zuege ..... D14/218  
D522,495 S \* 6/2006 Papoula ..... D14/218  
7,151,237 B2 \* 12/2006 Mahoney ..... H01H 13/70  
200/512  
D572,205 S \* 7/2008 Landerholm ..... D13/168  
D617,744 S \* 6/2010 Landerholm ..... D13/168  
D631,853 S \* 2/2011 Choi ..... D13/168  
D633,447 S \* 3/2011 Schaal ..... D13/168  
D644,632 S \* 9/2011 Chiu ..... D14/218  
D656,105 S \* 3/2012 Cook ..... D13/168  
D763,830 S \* 8/2016 Jones ..... D14/218  
D776,640 S \* 1/2017 Simonian ..... D14/218  
D808,454 S \* 1/2018 Seflic ..... D16/200  
D829,182 S 9/2018 Li  
D867,345 S \* 11/2019 Zhuang ..... D14/218

(57) **CLAIM**

The ornamental design for a massager controller, as shown and described.

**DESCRIPTION**

FIG. 1 is a front, left, and top perspective view of a massager controller, showing my design.  
FIG. 2 is a front elevation view thereof.  
FIG. 3 is a rear elevation view thereof.  
FIG. 4 is a left side elevation view thereof.  
FIG. 5 is a right side elevation view thereof.  
FIG. 6 is a top plan view thereof; and,  
FIG. 7 is a bottom plan view thereof.  
The broken lines shown in the drawings are included for the purpose of illustrating portions of the massager controller that form no part of the claimed design.

**1 Claim, 7 Drawing Sheets**

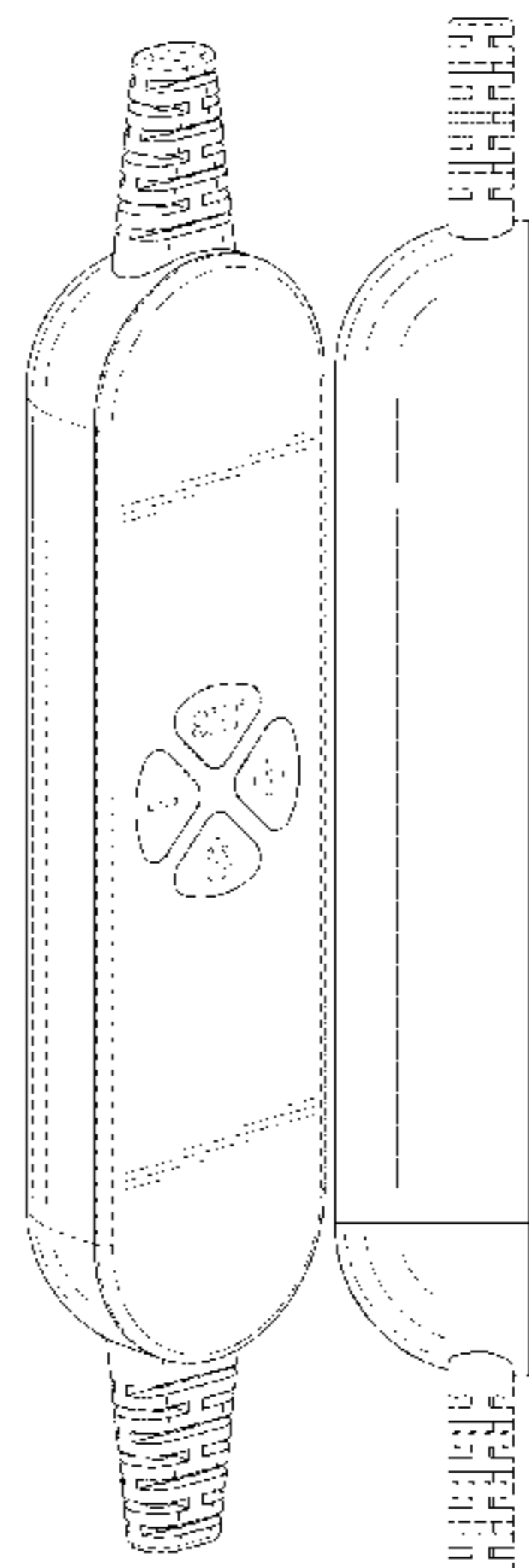

(56)

**References Cited**

U.S. PATENT DOCUMENTS

2009/0095602 A1\* 4/2009 Jensen ..... H01H 3/08  
 200/42.02  
 2010/0213042 A1\* 8/2010 Smidt ..... A47C 31/008  
 200/293  
 2014/0268645 A1\* 9/2014 Wang ..... F21V 33/0004  
 362/85  
 2016/0275785 A1\* 9/2016 Hille ..... A47C 7/62  
 2020/0060908 A1\* 2/2020 Hosokawa ..... A47C 31/008  
 2020/0253379 A1\* 8/2020 Song ..... A47C 1/03211  
 2020/0305256 A1\* 9/2020 Tachikawa ..... A61G 7/057  
 2021/0204718 A1\* 7/2021 Ohno ..... A47C 31/008

OTHER PUBLICATIONS

Lift Chairs Power Recliners 2 Button Remote Controller; Sep. 13, 2020; 2 pgs.;[https://www.amazon.com/Fruhdi-Recliners-Handset-](https://www.amazon.com/Fruhdi-Recliners-Handset-Controller-Control/dp/B08LSYHNSH/ref=asc_df_B08LSYHNSH?tag=bingshoppinga-20&linkCode=df0&hvadid=80882933917530&hvnetw=o&hvqmt=e&hvbmt=be&hvdev=c&hvlocint=&hvlocphy=&hvtargid=pla-458448246549982)

[Controller-Control/dp/B08LSYHNSH/ref=asc\\_df\\_B08LSYHNSH?tag=bingshoppinga-20&linkCode=df0&hvadid=80882933917530&hvnetw=o&hvqmt=e&hvbmt=be&hvdev=c&hvlocint=&hvlocphy=&hvtargid=pla-458448246549982](https://www.amazon.com/IdeaEuropa-Recliners-Handset-Controller-Furniture/dp/B09LHSH72N/ref=asc_df_B09LHSH72N?tag=bingshoppinga-20&linkCode=df0&hvadid=80127036476452&hvnetw=o&hvqmt=e&hvbmt=be&hvdev=c&hvlocint=&hvlocphy=&hvtargid=pla-4583726557225636&psc=1).\*

IdeaEuropa 6 Button Remote; Nov. 10, 2021; 2 pgs.;[https://www.amazon.com/IdeaEuropa-Recliners-Handset-Controller-Furniture/dp/B09LHSH72N/ref=asc\\_df\\_B09LHSH72N?tag=bingshoppinga-20&linkCode=df0&hvadid=80127036476452&hvnetw=o&hvqmt=e&hvbmt=be&hvdev=c&hvlocint=&hvlocphy=&hvtargid=pla-4583726557225636&psc=1](https://www.amazon.com/IdeaEuropa-Recliners-Handset-Controller-Furniture/dp/B09LHSH72N/ref=asc_df_B09LHSH72N?tag=bingshoppinga-20&linkCode=df0&hvadid=80127036476452&hvnetw=o&hvqmt=e&hvbmt=be&hvdev=c&hvlocint=&hvlocphy=&hvtargid=pla-4583726557225636&psc=1).\*

Fruhdi 6 Button 5 Pin Prong ML89-A2 Hand Control Handset Remote; Mar. 3, 2022; 2 pgs; [https://www.amazon.com/dp/B09TTPP13Z/ref=sspa\\_dk\\_detail\\_1?psc=1&pd\\_rd\\_i=B09TTPP13Z&pd\\_rd\\_w=mKnop&pf\\_rd\\_p=3e4e26e0-26f3-46d3-96b2-388480e296f7&pd\\_rd\\_wg=ecb5c&pf\\_rd\\_r=PNAMK1M4NCAZ1H3YKG31&pd\\_rd\\_r=ee129891-6512-4821-9904-680ca30d1dce&](https://www.amazon.com/dp/B09TTPP13Z/ref=sspa_dk_detail_1?psc=1&pd_rd_i=B09TTPP13Z&pd_rd_w=mKnop&pf_rd_p=3e4e26e0-26f3-46d3-96b2-388480e296f7&pd_rd_wg=ecb5c&pf_rd_r=PNAMK1M4NCAZ1H3YKG31&pd_rd_r=ee129891-6512-4821-9904-680ca30d1dce&).\*

\* cited by examiner

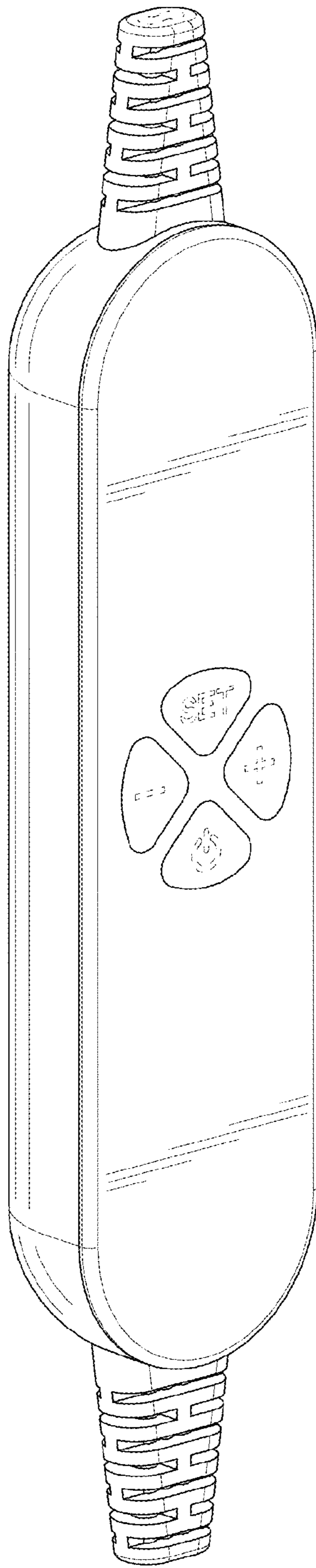

FIG. 1

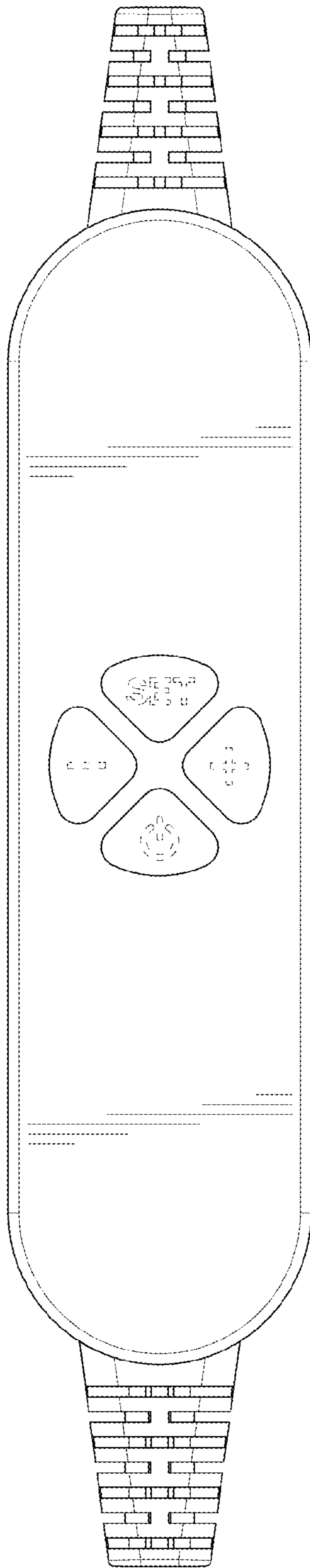

FIG. 2

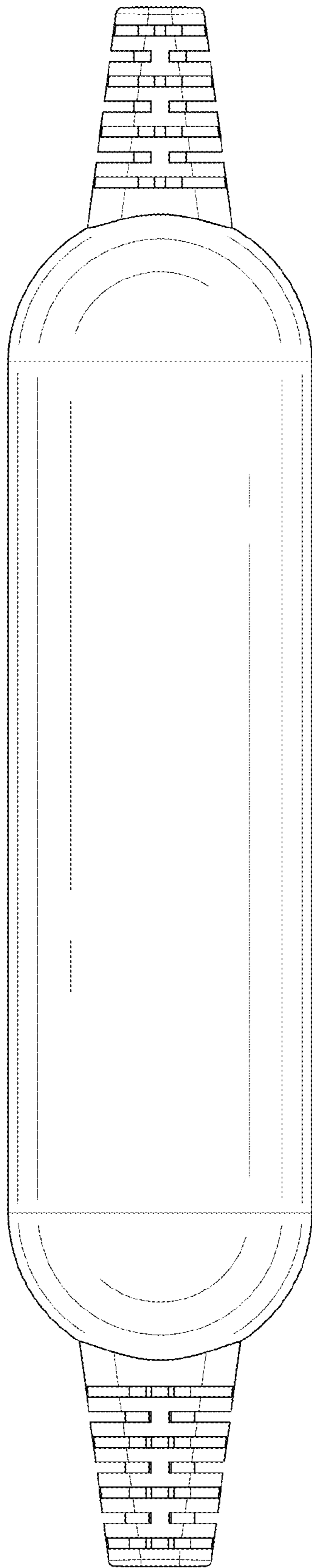

FIG. 3

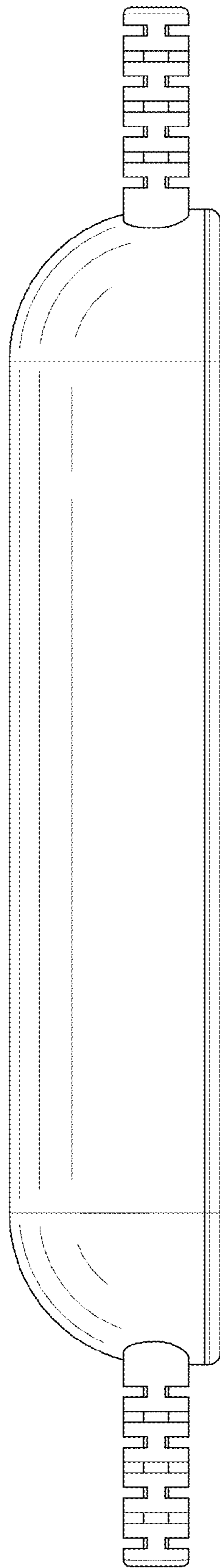

FIG. 4

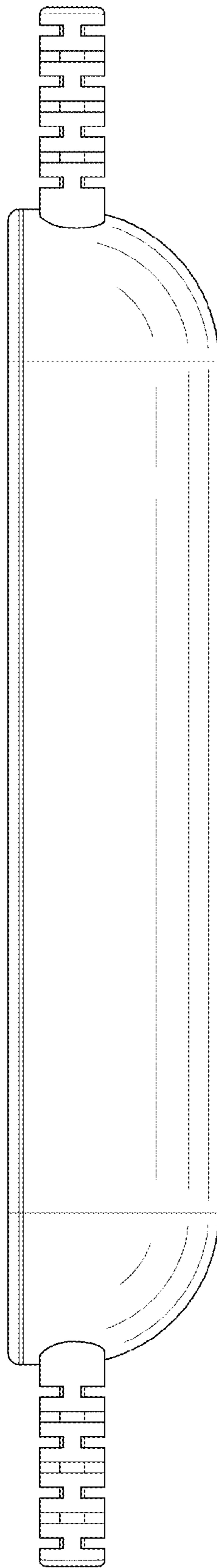

FIG. 5

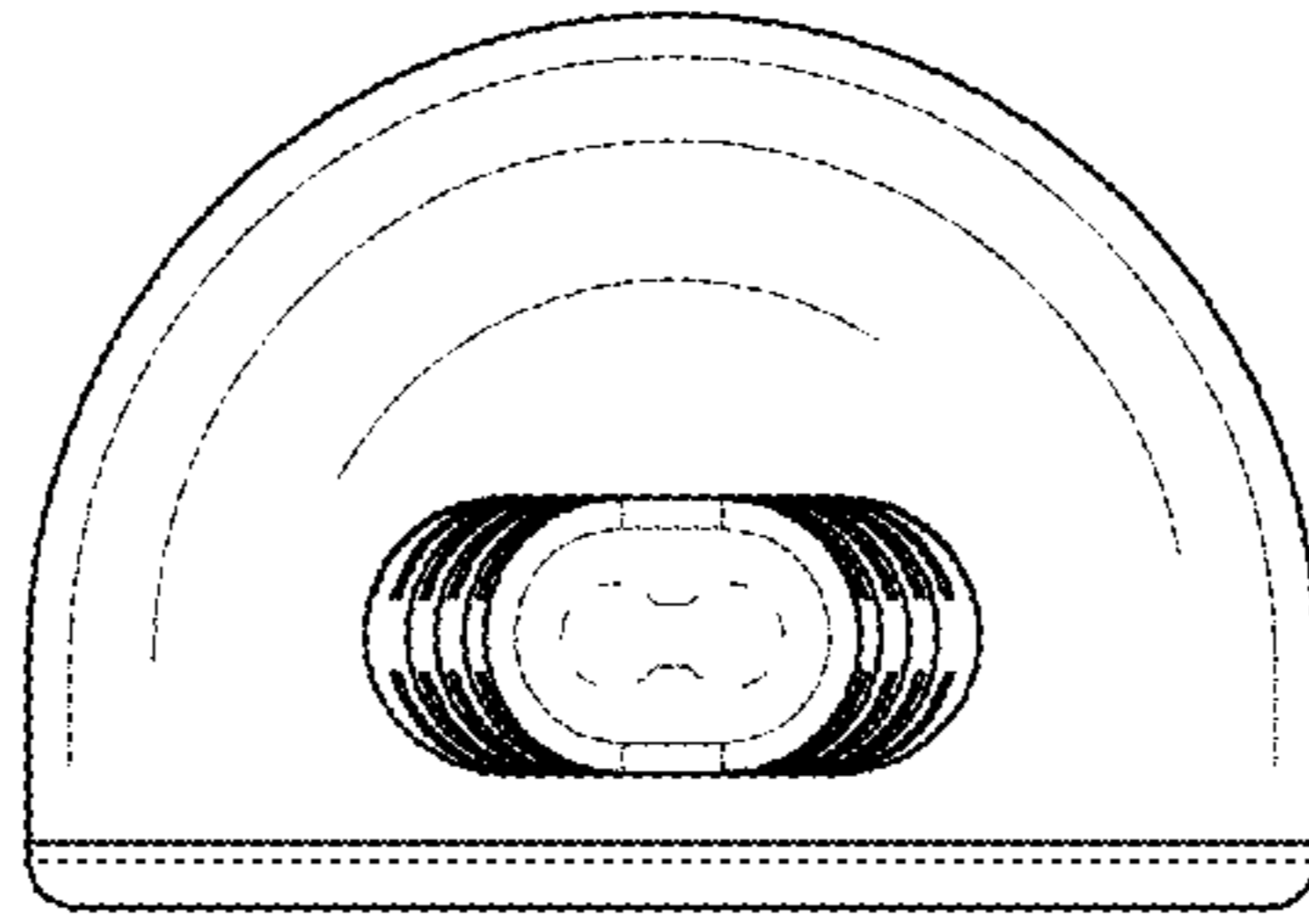

FIG. 6



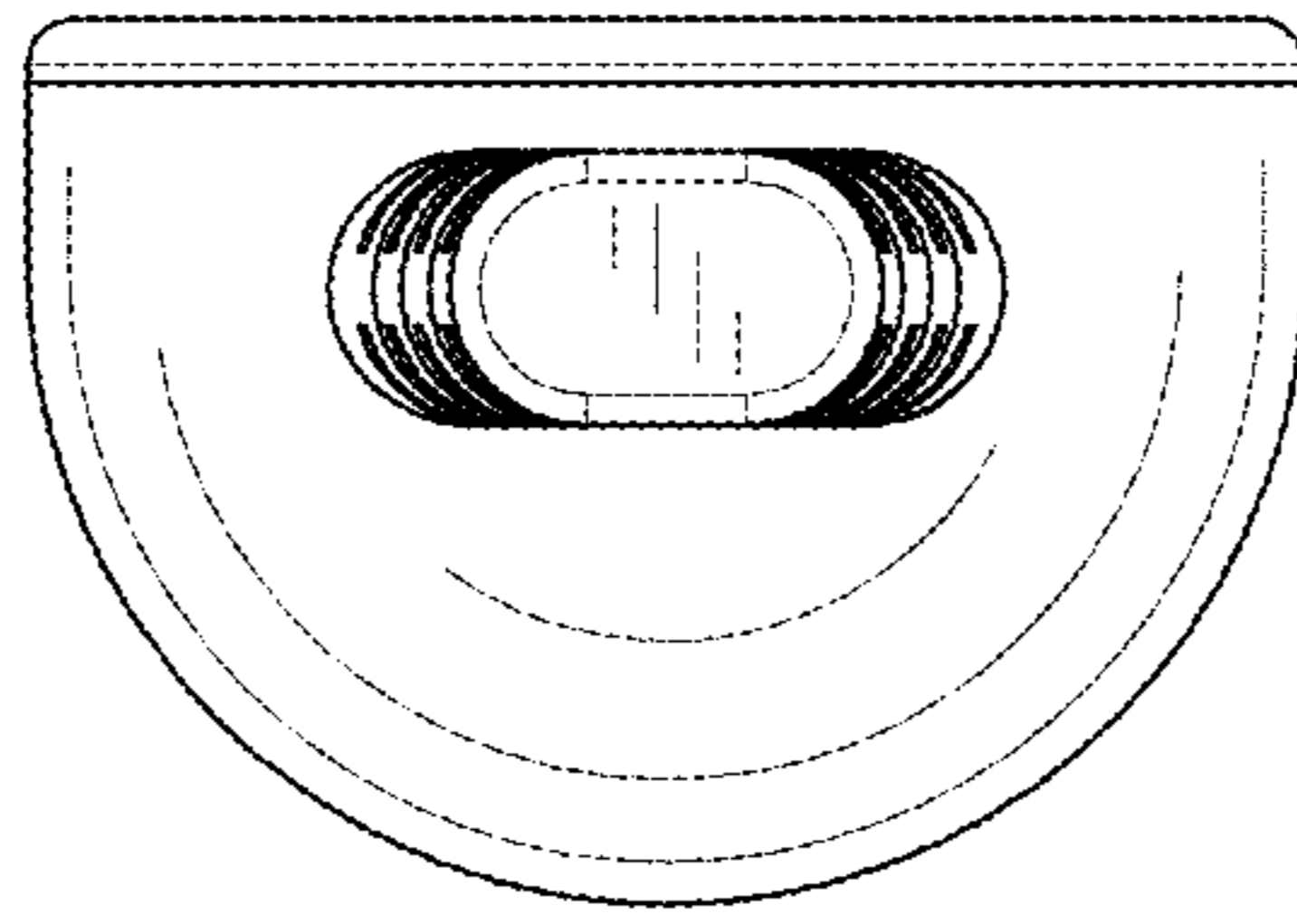

FIG. 7