



US00D955323S

(12) **United States Design Patent**  
**Reid et al.**

(10) **Patent No.:** **US D955,323 S**  
(45) **Date of Patent:** **\*\* Jun. 21, 2022**

(54) **STORAGE CONTAINER**

- (71) Applicant: **PACCAR Inc**, Bellevue, WA (US)
- (72) Inventors: **Andrew Reid**, Bellevue, WA (US);  
**Jonathan Duncan**, Bellevue, WA (US);  
**Rebecca Kern**, Bellevue, WA (US)
- (73) Assignee: **PACCAR Inc**, Bellevue, WA (US)
- (\*\*) Term: **15 Years**
- (21) Appl. No.: **29/760,258**
- (22) Filed: **Nov. 30, 2020**
- (51) **LOC (13) Cl.** ..... **12-16**
- (52) **U.S. Cl.**  
USPC ..... **D12/425**
- (58) **Field of Classification Search**  
USPC ..... D12/425, 400, 406, 415-420, 424, 426  
CPC ..... B63B 25/00; B63B 7/085; B63B 35/00;  
B63B 17/00; B60R 16/04  
See application file for complete search history.

(56) **References Cited**

**U.S. PATENT DOCUMENTS**

D264,525 S *	5/1982	Page, Jr.	.....	D12/419
5,170,720 A *	12/1992	Scheurer	.....	B60N 3/002
				108/146
D362,837 S *	10/1995	Mankey	.....	D12/419
D380,727 S *	7/1997	Gilstrap	.....	D6/406.5
D415,995 S *	11/1999	Kanehl, Jr.	.....	D12/419
D419,521 S *	1/2000	Leschke	.....	D19/75
6,279,798 B1 *	8/2001	Partch	.....	B60N 2/286
				297/188.2
D474,733 S *	5/2003	Webb	.....	D12/419
D484,843 S *	1/2004	Wyszogrod	.....	D12/419
D932,420 S *	10/2021	Bruni	.....	D12/425
D935,381 S *	11/2021	Chen	.....	D12/425
D940,057 S *	1/2022	Guo	.....	D12/425
2007/0113757 A1 *	5/2007	Lilly	.....	A47G 23/0608
				108/25

**OTHER PUBLICATIONS**

- “T800,” Kenworth Truck Company, 2002, 32-page brochure.
- “T800,” Kenworth Truck Company, 2003, 32-page brochure.
- “T800,” Kenworth Truck Company, 2005, 28-page brochure.
- “T800,” Kenworth Truck Company, 2009, 28-page brochure.
- “T800B,” Kenworth Truck Company, 1993, 8-page brochure.
- Peterbilt Motors Company, “The Working Class,” Sep. 1976, 6-page brochure.
- “The World’s Best,” Kenworth Truck Company, 1992, 12-page brochure.
- “W900,” Kenworth Truck Company, 1996, 7-page brochure.
- “W900,” Kenworth Truck Company, 2002, 32-page brochure.

(Continued)

*Primary Examiner* — Katrina A Betton

(74) *Attorney, Agent, or Firm* — Seed IP Law Group LLP

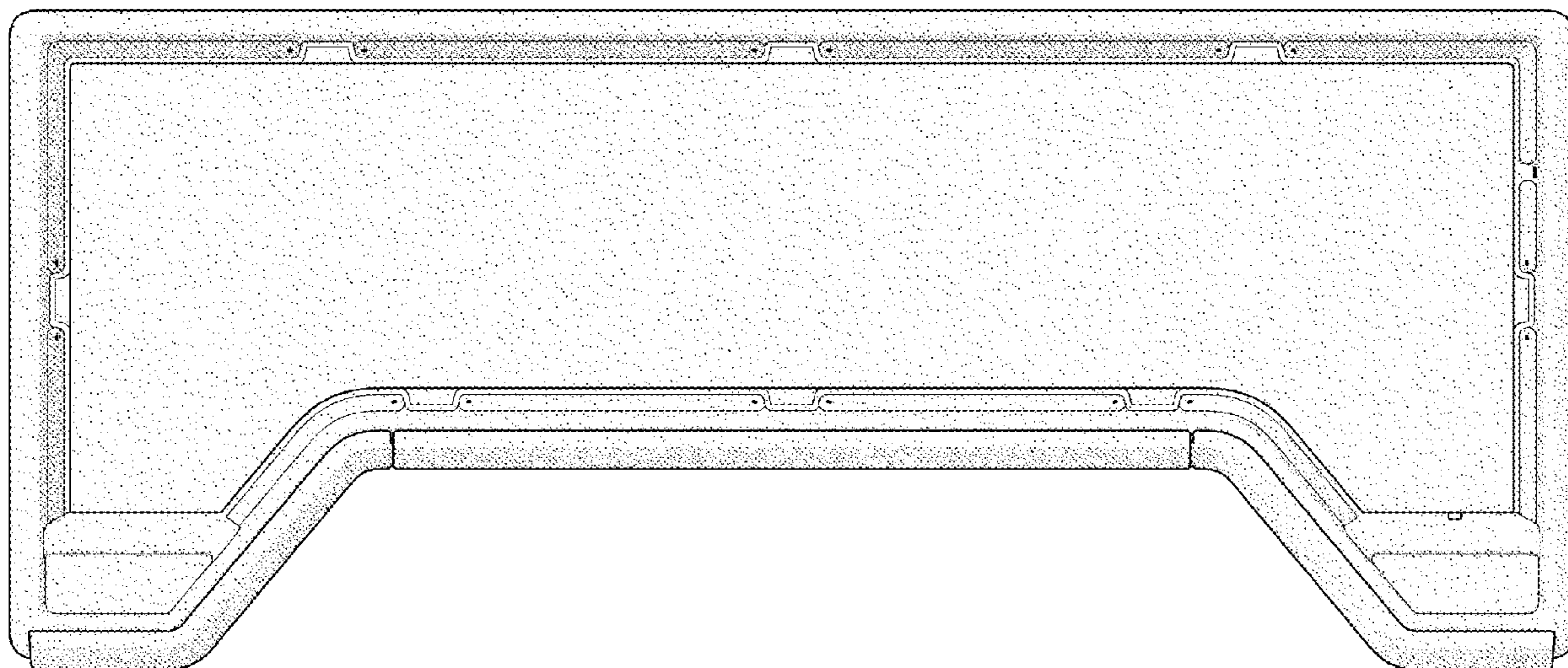
(57) **CLAIM**

The ornamental design for a storage container, as shown and described.

**DESCRIPTION**

FIG. 1 is a top isometric view of a storage container, showing our new design.  
 FIG. 2 is a bottom isometric view thereof.  
 FIG. 3 is a front elevational view thereof.  
 FIG. 4 is a rear elevational view thereof.  
 FIG. 5 is a left side elevational view thereof.  
 FIG. 6 is a right side elevational view thereof.  
 FIG. 7 is a top plan view thereof; and,  
 FIG. 8 is a bottom plan view thereof.  
 Stippling and tangency lines in the drawings represent the three-dimensional contours of the design, and are not intended to indicate surface decoration. The broken lines shown in the drawings depict portions of the storage container that form no part of the claimed design.

**1 Claim, 8 Drawing Sheets**



(56)

**References Cited**

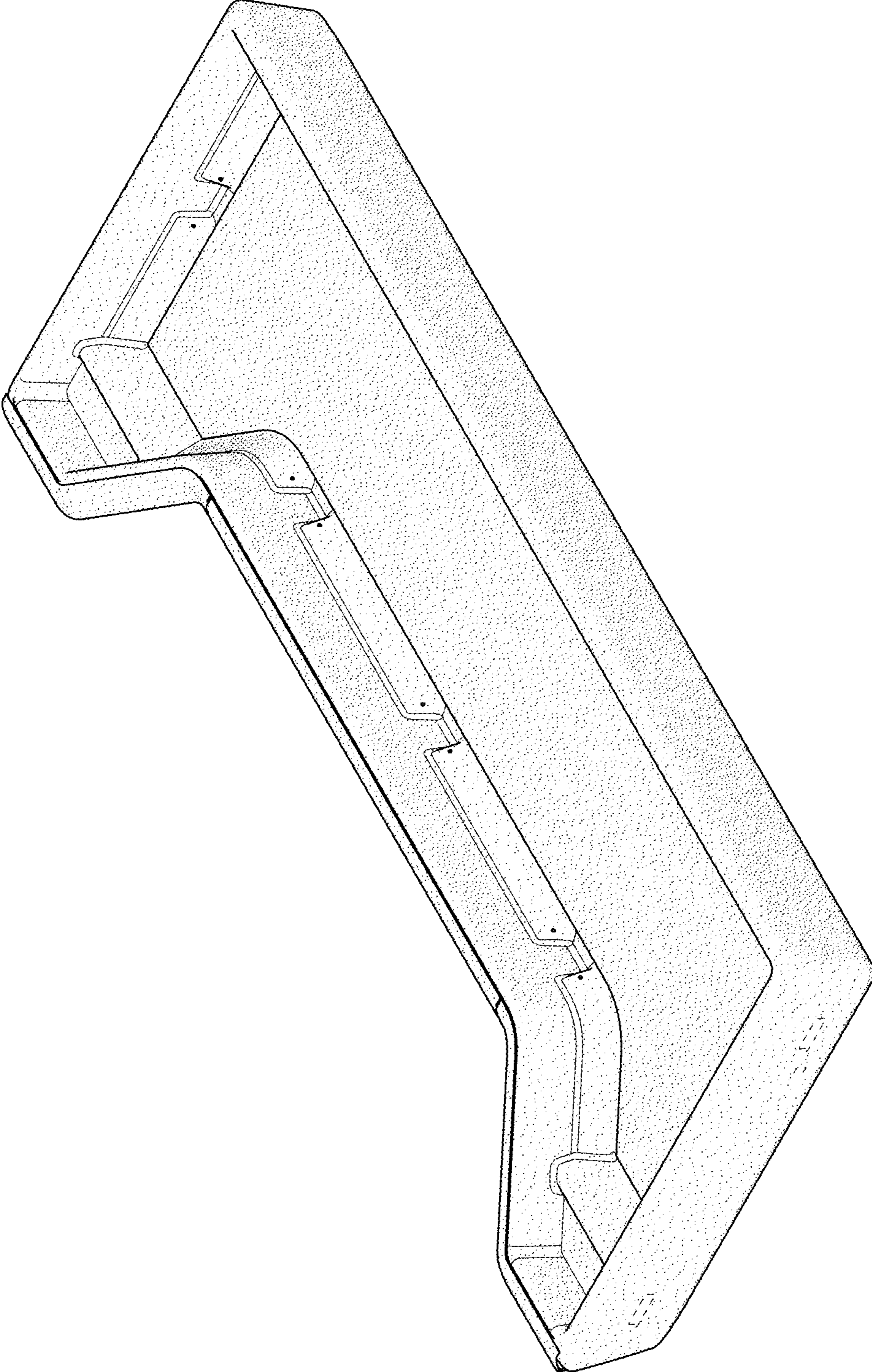
## OTHER PUBLICATIONS

“W900,” Kenworth Truck Company, 2005, 28-page brochure.  
 “W900,” Kenworth Truck Company, 2009, 28-page brochure.  
 Kenworth Truck Company, “W900L AeroCab,” 1994, 2-page brochure.  
 Kenworth Truck Company, “AeroCab,” 1993, 5-page brochure.  
 “AeroCab,” Kenworth Truck Company, as early as 1995, 3-page brochure.  
 “C500B,” Kenworth Truck Company, as early as 1990, 4-page brochure.  
 Peterbilt Motors Company, “Class Pays, Medium Duty,” Sep. 2000, 12-page brochure.  
 “Class Pays, Truck Models,” Peterbilt Motors Company, Mar. 2005, 24-page brochure.  
 “Class Pays,” Peterbilt Motors Company, Nov. 1998, 10-page brochure.  
 Peterbilt Motors Company, “Class Pays,” Sep. 1997, 10-page brochure.  
 “Class Pays, Construction Trucks,” Peterbilt Motors Company, Nov. 2003, 16-page brochure.  
 “Kenworth Truck Models,” Kenworth Truck Company, 2010, 16-page brochure.  
 Peterbilt Motors Company, “Model 330,” Oct. 1997, 3-page brochure.  
 Peterbilt Motors Company, “Model 379,” Apr. 2005, 2-page brochure.  
 Peterbilt Motors Company, “Model 379,” Mar. 1996, 5-page brochure.  
 Peterbilt Motors Company, “Rest with Class,” Apr. 1978, 4-page brochure.  
 “T170 Class 5,” Kenworth Truck Company, 2008, 4-page brochure.  
 “T270 Class 6 and T370 Class 7,” Kenworth Truck Company, 2008, 6-page brochure.  
 “T270 Class 6 and T370 Class 7,” Kenworth Truck Company, 2009, 6-page brochure.  
 “T270 Class 6 and T370 Class 7 Hybrid,” Kenworth Truck Company, 2009, 6-page brochure.  
 “T680,” Kenworth Truck Company, 2013, 34-page brochure.

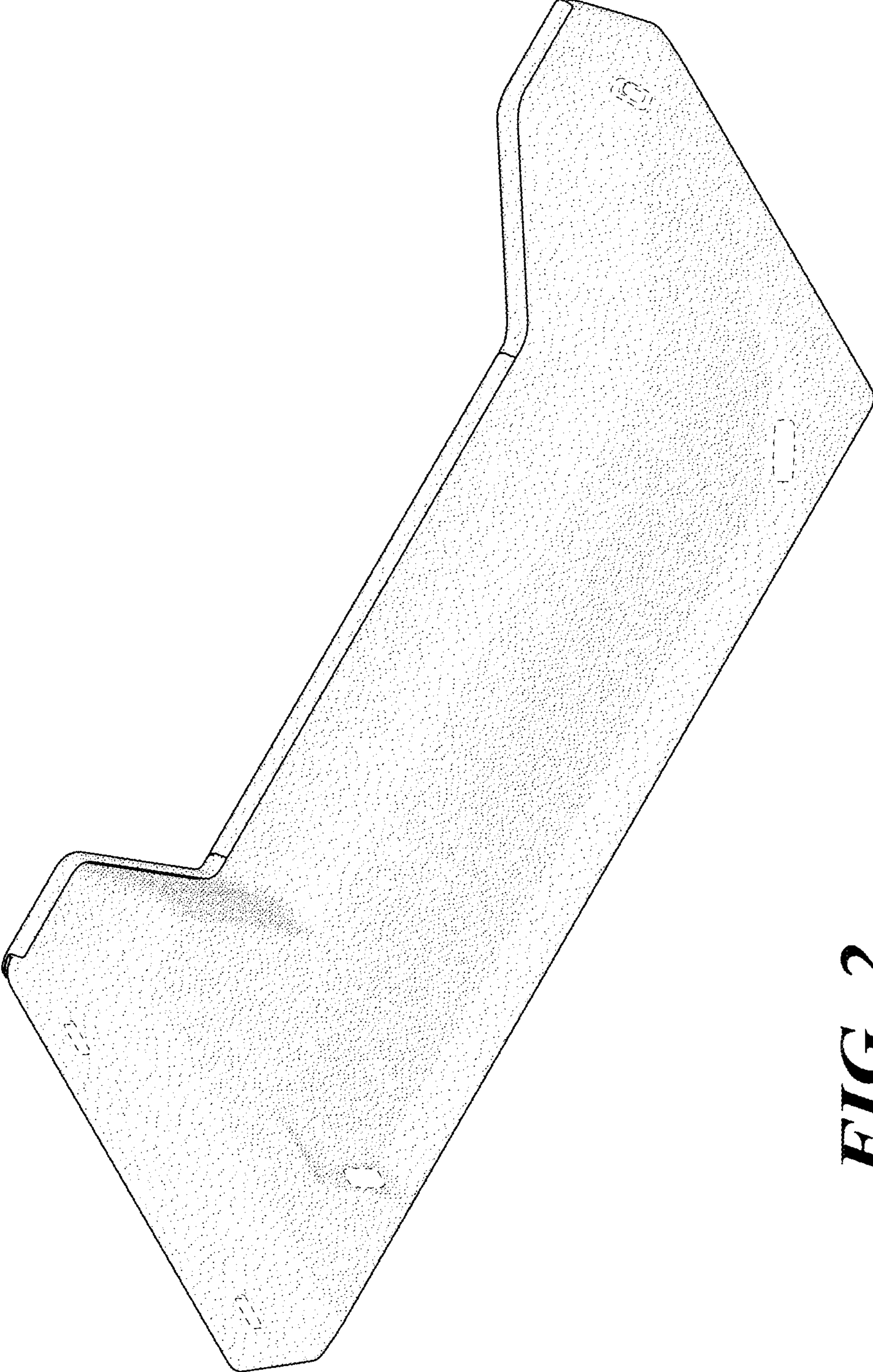
“T680,” Kenworth Truck Company, 2016, 34-page brochure.  
 “T880,” Kenworth Truck Company, 2017, 32-page brochure.  
 “Model 579,” Peterbilt Motors Company, Oct. 2013, 13-page brochure.  
 “Medium Duty,” Peterbilt Motors Company, 2013, 9-page brochure.  
 “On-Highway,” Peterbilt Motors Company, 2013, 13-page brochure.  
 “Vocational,” Peterbilt Motors Company, 2013, 11-page brochure.  
 “T440,” Kenworth Truck Company, 2010, 6-page brochure.  
 “T470,” Kenworth Truck Company, 2010, 6-page brochure.  
 “T470H,” Kenworth Truck Company, 2009, 2-page brochure.  
 “Model 220,” Peterbilt Motors Company, 2019, 2-page brochure.  
 “220EV,” Peterbilt Motors Company, 2020, 5-page brochure.  
 “Model 337,” Peterbilt Motors Company, 2020, 2-page brochure.  
 “Model 389,” Peterbilt Motors Company, 2019, 2-page brochure.  
 “Model 348,” Peterbilt Motors Company, 2019, 2-page brochure.  
 “Model 520,” Peterbilt Motors Company, 2019, 2-page brochure.  
 “Model 567,” Peterbilt Motors Company, 2020, 16-page brochure.  
 “567 Heritage,” Peterbilt Motors Company, 2017, 2-page brochure.  
 “Model 579,” Peterbilt Motors Company, 2019, 28-page brochure.  
 “C500,” Kenworth Truck Company, 2012, 2-page brochure.  
 “T680,” Kenworth Truck Company, 2019, 40-page brochure.  
 “T800,” Kenworth Truck Company, 2012, 28-page brochure.  
 “T440/T470,” Kenworth Truck Company, 2015, 8-page brochure.  
 “K270E/K370E,” Kenworth Truck Company, 2020, 4-page brochure.  
 “T170/T270/T370,” Kenworth Truck Company, 2019, 16-page brochure.  
 “K270/K370,” Kenworth Truck Company, 2014, 12-page brochure.  
 “W990,” Kenworth Truck Company, 2018, 32-page brochure.  
 “T880,” Kenworth Truck Company, 2019, 36-page brochure.  
 “Model 367,” Peterbilt Motors Company, <https://www.peterbilt.com/trucks/vocational/model-367>, retrieved Nov. 20, 2020, 12 pages.  
 “Model 365,” Peterbilt Motors Company, <https://www.peterbilt.com/trucks/vocational/model-365>, retrieved Nov. 20, 2020, 11 pages.  
 “Model 325,” Peterbilt Motors Company, <https://www.peterbilt.com/trucks/medium-duty/model-325>, retrieved Nov. 20, 2020, 12 pages.

\* cited by examiner

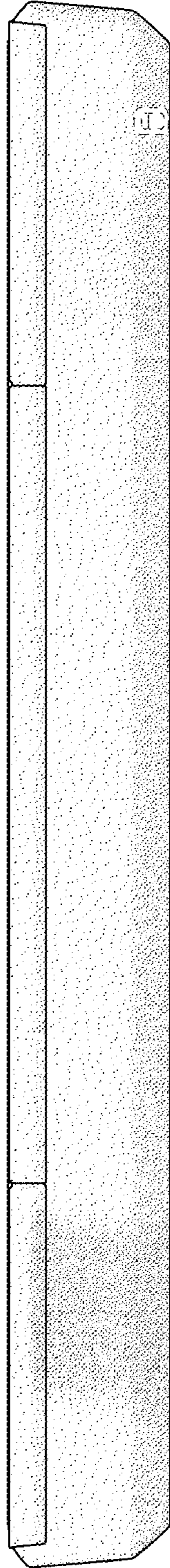




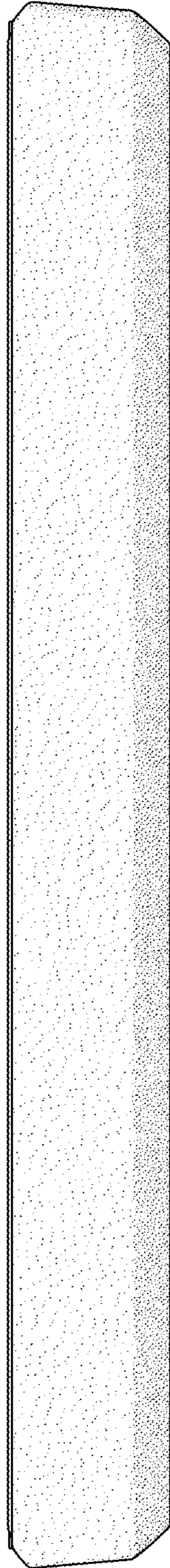
**FIG. 1**



**FIG. 2**

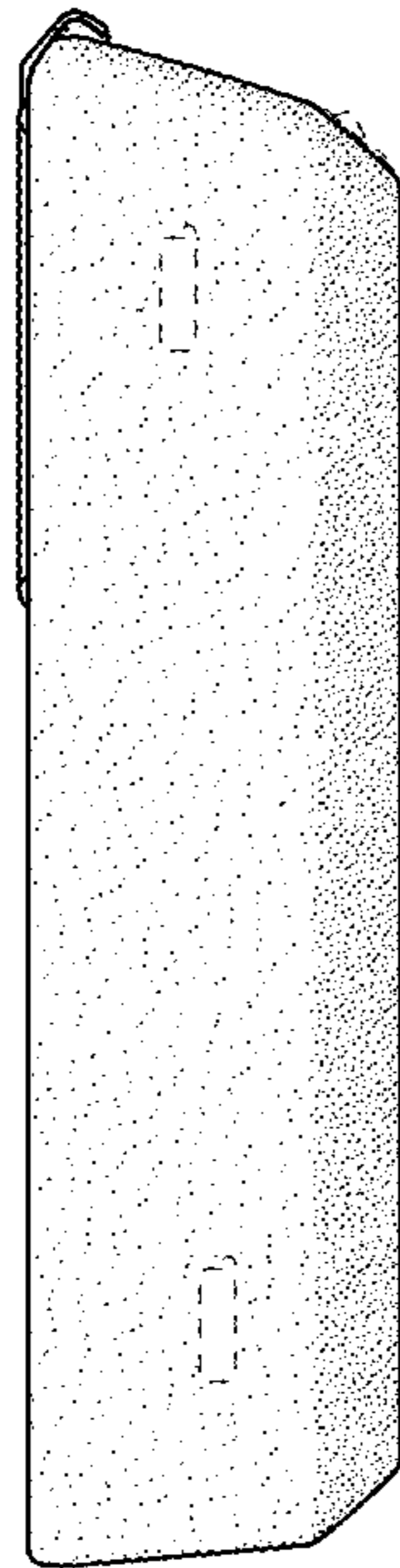


**FIG. 3**

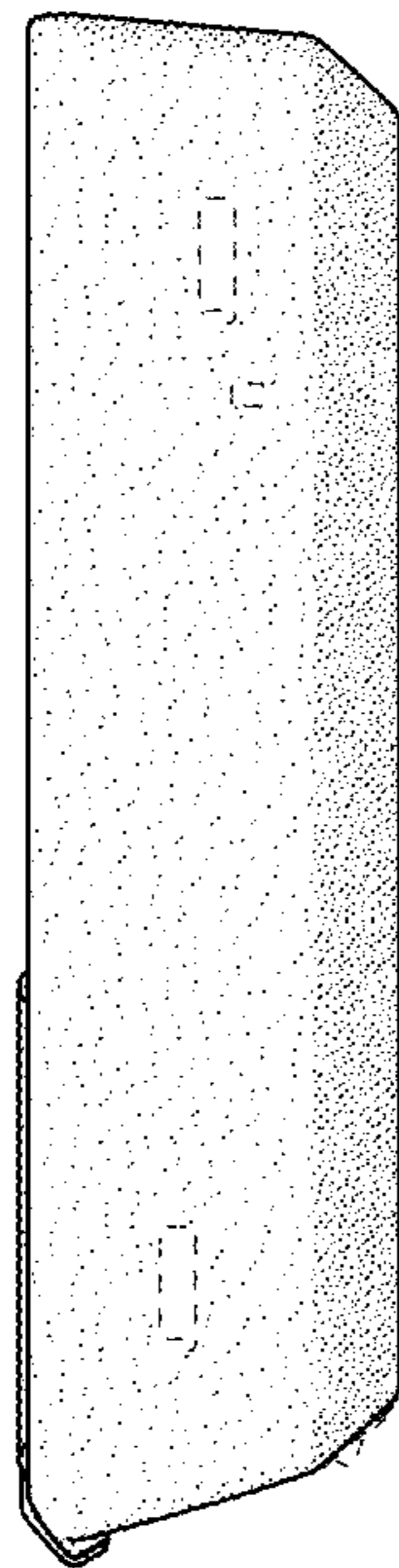


**FIG. 4**



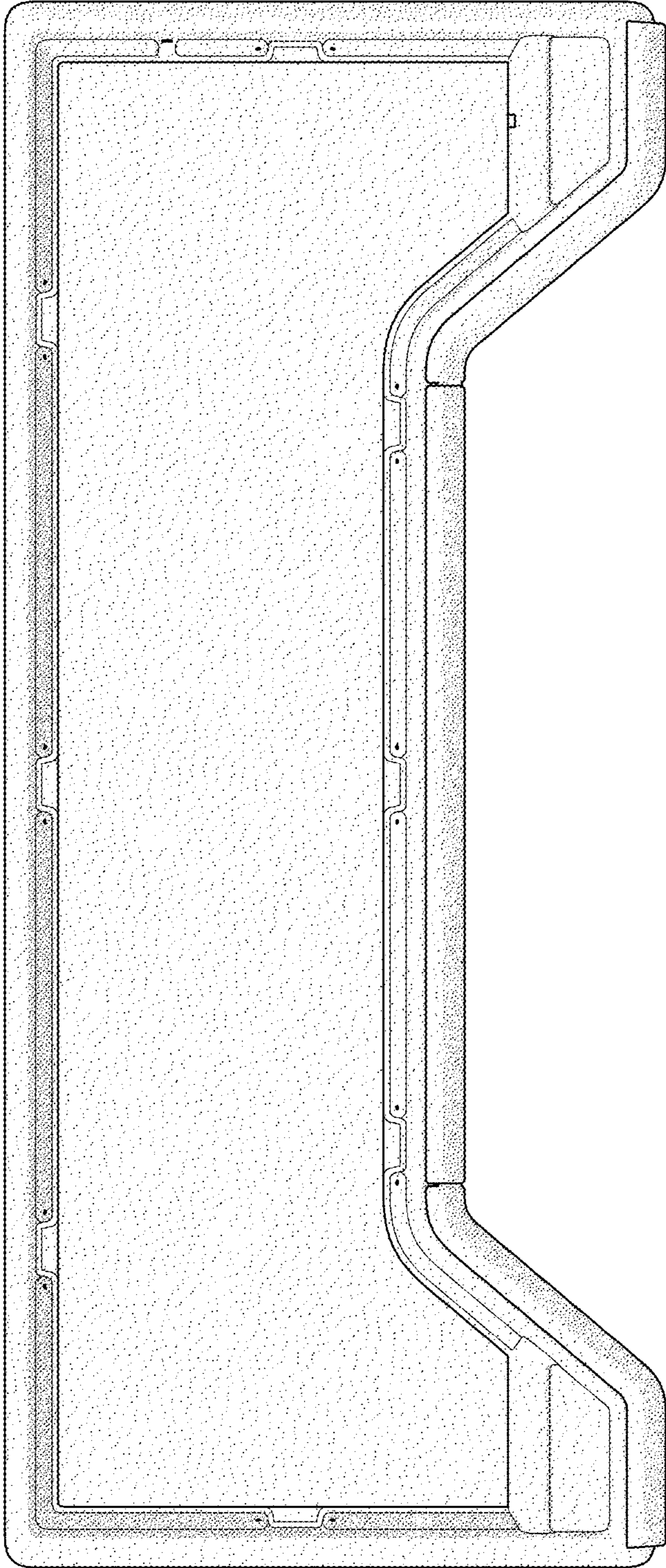


**FIG. 5**

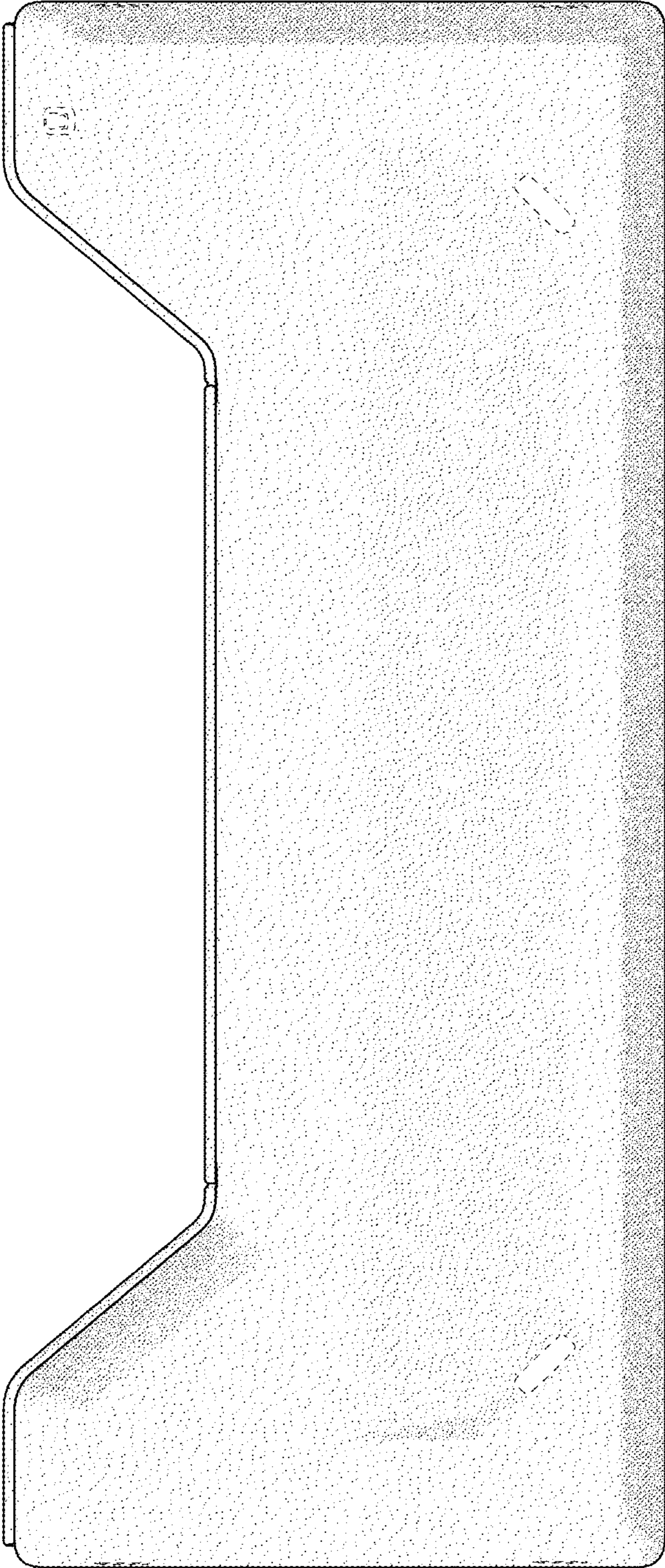


**FIG. 6**





**FIG. 7**



**FIG. 8**