



US00D955247S

(12) **United States Design Patent** (10) **Patent No.:** **US D955,247 S**  
**Vespa et al.** (45) **Date of Patent:** **\*\* Jun. 21, 2022**

(54) **PET SCALE**

(71) Applicant: **Société des Produits Nestlé S.A.**,  
Vevey (CH)  
(72) Inventors: **William Joseph Vespa**, Quincy, MA  
(US); **William Broun**, University City,  
MO (US); **Mark Donavon**, Troy, IL  
(US); **Kristin Slater**, St. Louis, MO  
(US); **Ragen Trudelle-Schwarz**  
**McGowan**, Saint Joseph, MO (US);  
**James Collins**, Larkspur, CA (US);  
**Gregg Robert Draudt**, Stow, MA  
(US); **Alex Sutton**, Healdsburg, CA  
(US); **Roberto Vargas**, San Francisco,  
CA (US)

(73) Assignee: **SOCIÉTÉ DES PRODUITS NESTLÉ**  
**S.A.**, Vevey (CH)

(\*\*) Term: **15 Years**

(21) Appl. No.: **29/803,771**

(22) Filed: **Aug. 16, 2021**

(51) **LOC (13) Cl.** ..... **10-04**

(52) **U.S. Cl.**  
USPC ..... **D10/91; D10/92**

(58) **Field of Classification Search**  
USPC ..... **D10/83-97, 103**

(Continued)

(56) **References Cited**

**U.S. PATENT DOCUMENTS**

D587,152 S \* 2/2009 Scholpp ..... D10/92  
D587,153 S \* 2/2009 Scholpp ..... D10/92

(Continued)

**FOREIGN PATENT DOCUMENTS**

CN 306209448 \* 7/2020  
CN 306283604 \* 8/2020

(Continued)

**OTHER PUBLICATIONS**

SurmountWay, Shipping Scale, Date first available Apr. 7, 2021,  
[online]retrieved Mar. 8, 2022,available from [https://www.amazon.com/dp/B09217S3SH/ref=sspa\\_dk\\_detail\\_6?psc=1&pd\\_rd\\_i=B09217S3SH&pd\\_rd\\_w=1Umhb&pf\\_rd\\_p=b9951ce4-3bd8-4b04-9123-0fda35d6155e&pd\\_rd\\_wg=ltgUJ&pf\\_rd\\_r=HGVBXW6BDTXQHABV7YCRZ&pd\\_rd\\_r=2](https://www.amazon.com/dp/B09217S3SH/ref=sspa_dk_detail_6?psc=1&pd_rd_i=B09217S3SH&pd_rd_w=1Umhb&pf_rd_p=b9951ce4-3bd8-4b04-9123-0fda35d6155e&pd_rd_wg=ltgUJ&pf_rd_r=HGVBXW6BDTXQHABV7YCRZ&pd_rd_r=2) (Year: 2021).\*

(Continued)

*Primary Examiner* — Keli L Hill

*Assistant Examiner* — Sara S Sahneh

(74) *Attorney, Agent, or Firm* — Finnegan, Henderson,  
Farabow, Garrett & Dunner, LLP

(57) **CLAIM**

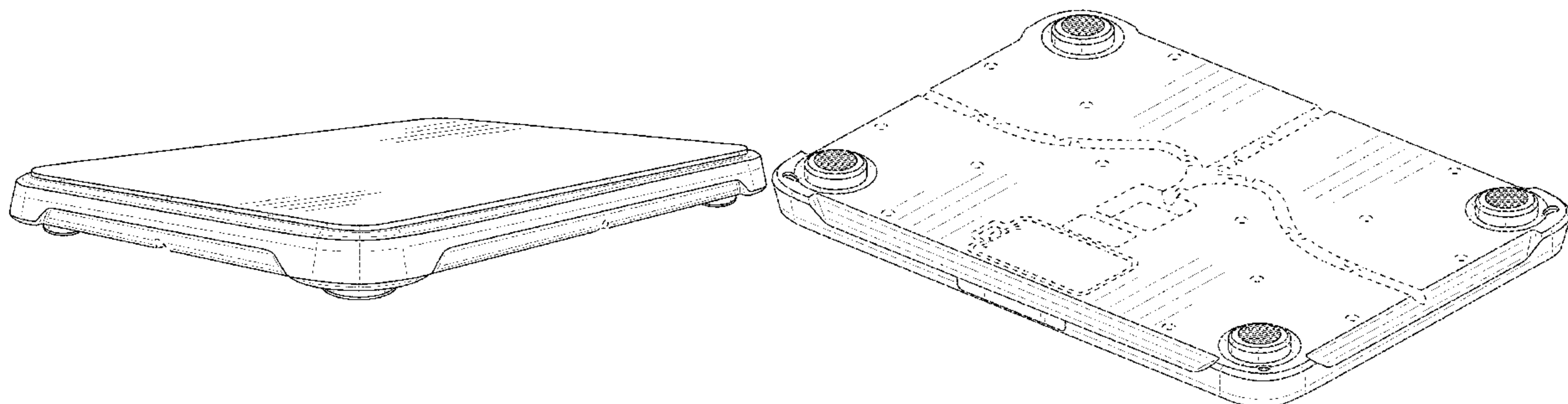
The ornamental design for a pet scale, as shown and  
described.

**DESCRIPTION**

FIG. 1 is a rear, right perspective view of a pet scale,  
showing our new design;  
FIG. 2 is a front, right perspective view thereof;  
FIG. 3 is a rear, left perspective view thereof;  
FIG. 4 is a front, left perspective view thereof;  
FIG. 5 is a left side perspective view thereof;  
FIG. 6 is a right side perspective view thereof;  
FIG. 7 is a rear perspective view thereof;  
FIG. 8 is a front perspective view thereof;  
FIG. 9 is a bottom, left perspective view thereof;  
FIG. 10 is a front elevation view thereof;  
FIG. 11 is a rear elevation view thereof;  
FIG. 12 is a left side view thereof;  
FIG. 13 is a right side view thereof;  
FIG. 14 is a top plan view thereof; and,  
FIG. 15 is a bottom plan view thereof.

The dash-dash broken lines illustrate portions of the pet  
scale that form no part of the claimed design.

**1 Claim, 15 Drawing Sheets**



(58) **Field of Classification Search**

CPC ..... G01G 17/08; G01G 19/14; G01G 19/60;  
 G01G 19/00; G01G 19/02; G01G 19/08;  
 G01G 19/22; G01G 19/387; G01G 19/40;  
 G01G 19/44; G01G 21/00; G01G 17/00;  
 G01G 21/28; G01G 19/414; G01G  
 19/4144; G01G 19/42; G01G 23/166;  
 G01G 21/30; G01G 23/3728; G01G  
 23/3735; G01G 3/14; G01G 19/46; G01G  
 19/48; G01G 19/50; G01G 21/44; A61B  
 5/053; A61B 5/4872; A61B 5/0537; A61B  
 5/4869; A61B 5/685; A61B 5/6829; A61B  
 5/7445; A61B 5/1072; G06Q 20/3678;  
 G06Q 20/387; G06Q 20/065; G06Q  
 20/36; G06Q 20/06; G06Q 20/208; G09B  
 19/00; G16H 20/00; G16H 40/63; F16F  
 1/123

See application file for complete search history.

(56) **References Cited**

U.S. PATENT DOCUMENTS

D689,485 S \* 9/2013 Chong ..... D14/366  
 D742,264 S \* 11/2015 Pan ..... D10/91  
 D801,837 S \* 11/2017 Tsai ..... D10/91  
 D808,287 S \* 1/2018 Liang ..... D10/92  
 D928,003 S \* 8/2021 Yu ..... D10/92  
 11,169,017 B1 \* 11/2021 Huckestein ..... A47K 3/002  
 D938,293 S \* 12/2021 Chan ..... D10/91  
 2014/0228648 A1 \* 8/2014 Goldberg ..... A61B 5/0002  
 600/587

2019/0041253 A1\* 2/2019 Van Der Hoek ..... A01K 29/00  
 2021/0007330 A1\* 1/2021 Huisma ..... G06Q 10/063  
 2021/0113155 A1\* 4/2021 Anliker ..... A61B 5/0295

FOREIGN PATENT DOCUMENTS

EM	006850384-0005	*	9/2019
GB	6093543	*	6/2020
GB	6098830	*	8/2020
GB	6190820	*	2/2022
KR	301081320.0000	*	10/2020

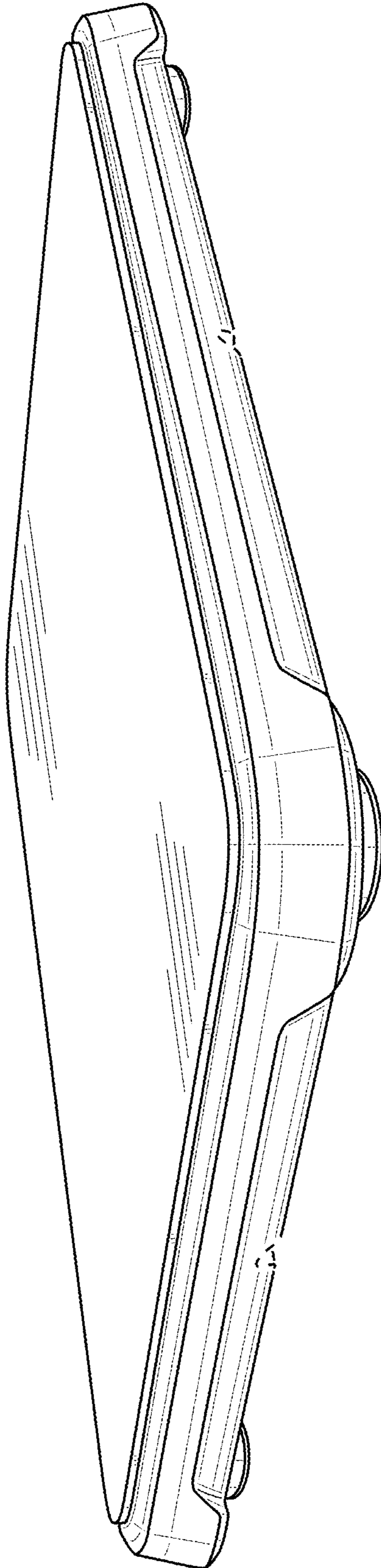
OTHER PUBLICATIONS

ONETWOTHREE Store, Digital pet Scale for Dogs, Date first available Oct. 25, 2018, [online]retrieved Mar. 8, 2022,available from [https://www.amazon.com/ONETWOTHREE-Digital-Weighing-Capacity-Precision/dp/B07JHS7HSC/ref=sr\\_1\\_21?crid=3BYKR0MWMWJ2T&keywords=pets+scale&qid=1646759125&srefix=pets+scale%2Caps%20](https://www.amazon.com/ONETWOTHREE-Digital-Weighing-Capacity-Precision/dp/B07JHS7HSC/ref=sr_1_21?crid=3BYKR0MWMWJ2T&keywords=pets+scale&qid=1646759125&srefix=pets+scale%2Caps%20) (Year: 2018).\*

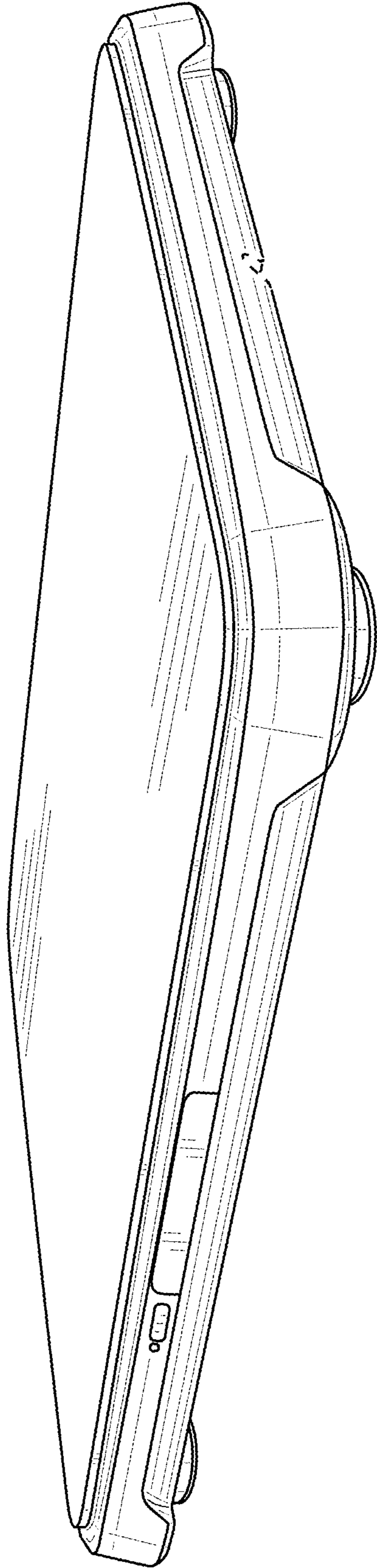
Smart Weigh Store, Digital Shipping and Postal Weight Scale,Date first available Feb. 5, 2014, [online]retrieved Mar. 8, 2022, available from [https://www.amazon.com/dp/B00I9D5IFM/ref=sspa\\_dk\\_detail\\_3?psc=1&pd\\_rd\\_i=B00I9D5IFM&pd\\_rd\\_w=BsYvk&pf\\_rd\\_p=57cbdc41-b731-4e3d-aca7-49078b13a07b&pd\\_rd\\_wg=rze1A&pf\\_r](https://www.amazon.com/dp/B00I9D5IFM/ref=sspa_dk_detail_3?psc=1&pd_rd_i=B00I9D5IFM&pd_rd_w=BsYvk&pf_rd_p=57cbdc41-b731-4e3d-aca7-49078b13a07b&pd_rd_wg=rze1A&pf_r) (Year: 2014).\*

Nicole Cosgrove, 10 Best Dog Scales in 2022—Reviews &Top Picks, Date first available 10 Best Dog Scales in 2022—Reviews & Top Picks, [online]retrieved Mar. 7, 2022,available from <https://www.hepper.com/best-dog-scales/> (Year: 2022).\*

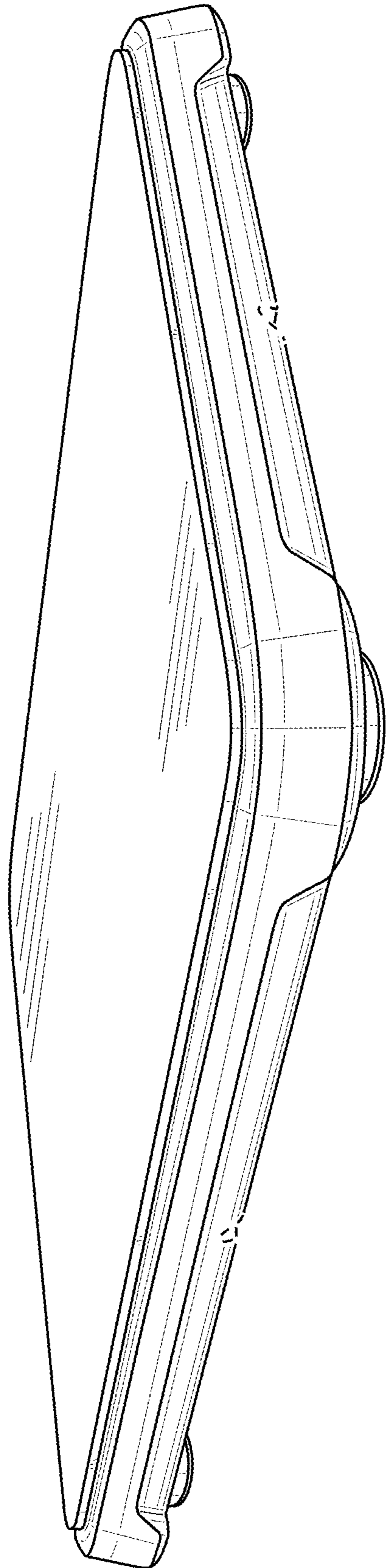
\* cited by examiner



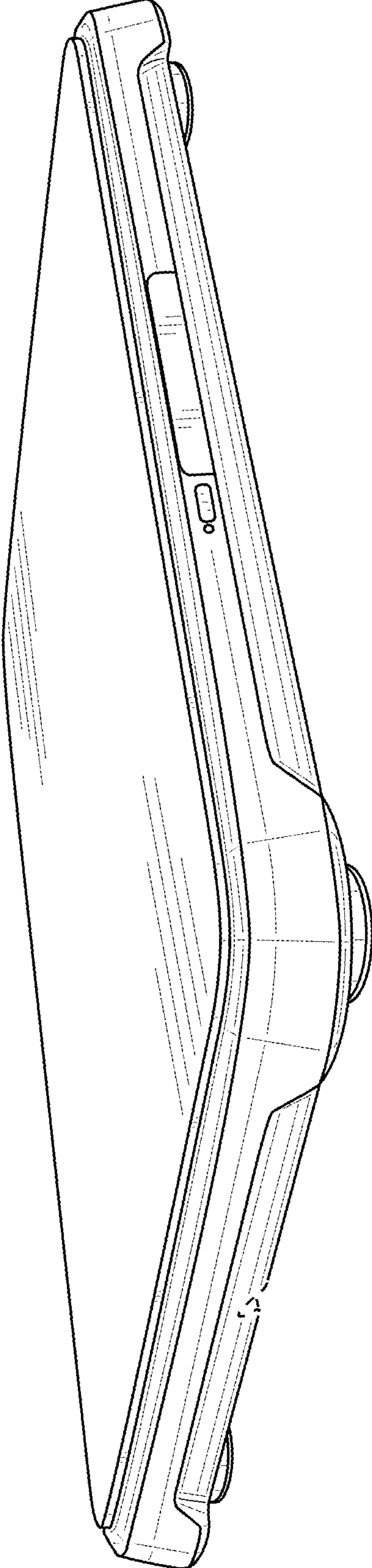
**FIG. 1**



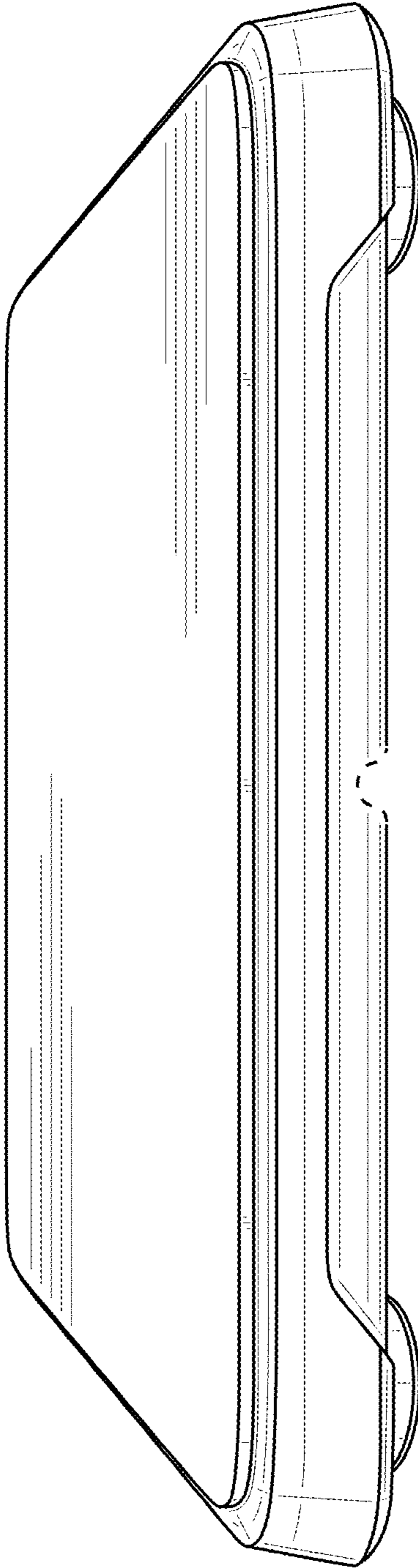
**FIG. 2**



**FIG. 3**



**FIG. 4**

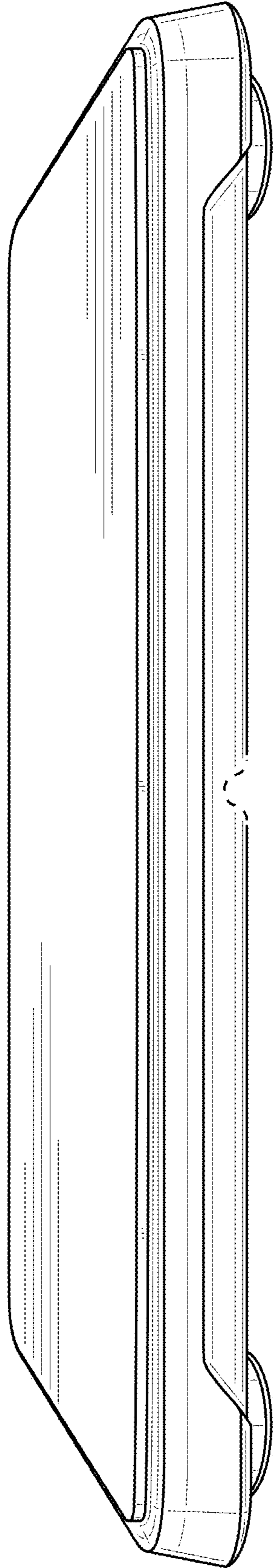


**FIG. 5**

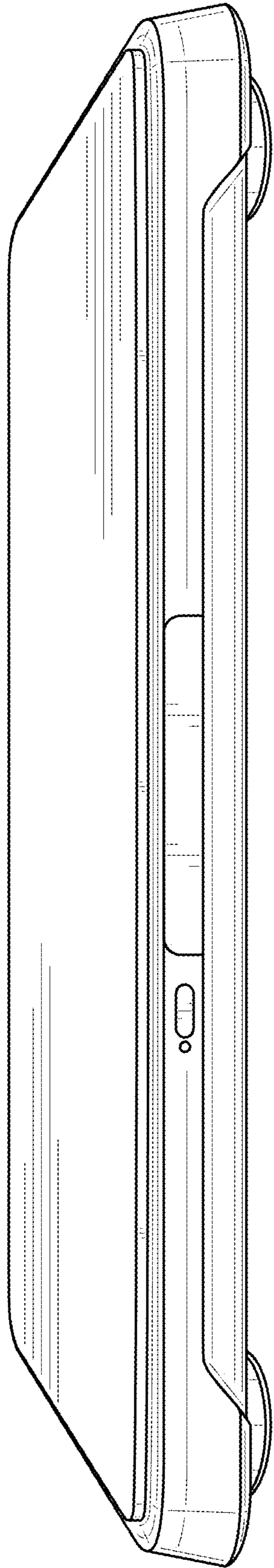


**FIG. 6**





**FIG. 7**



**FIG. 8**

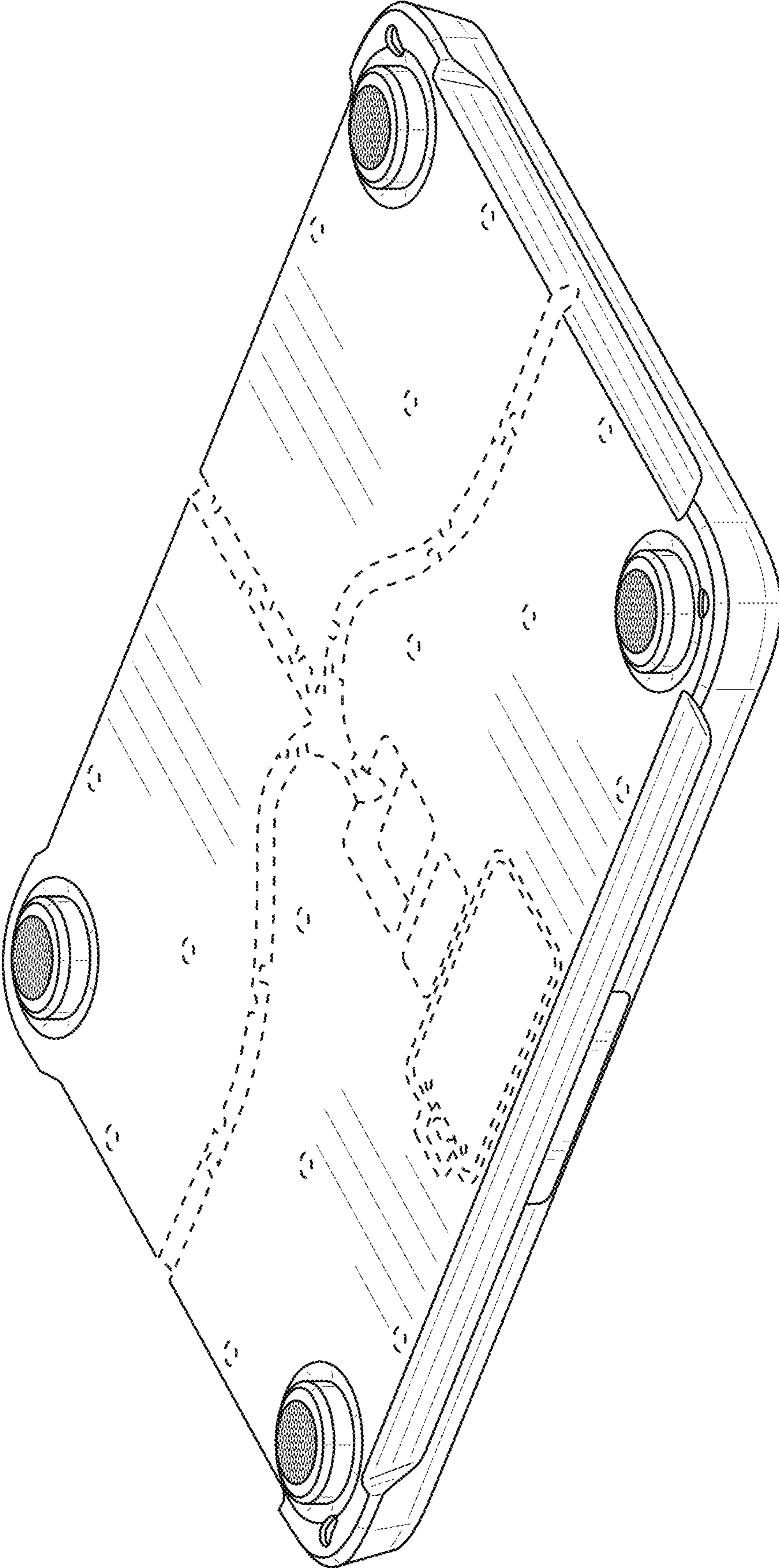
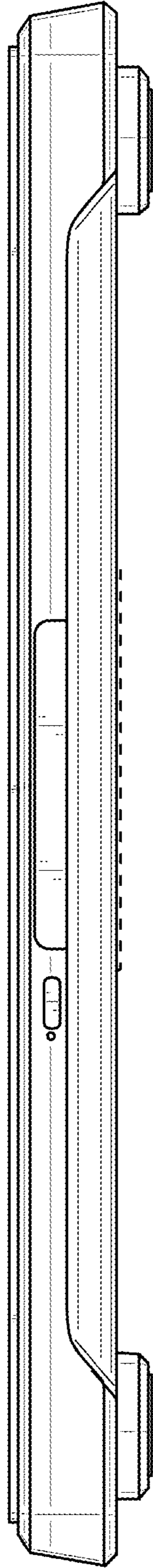
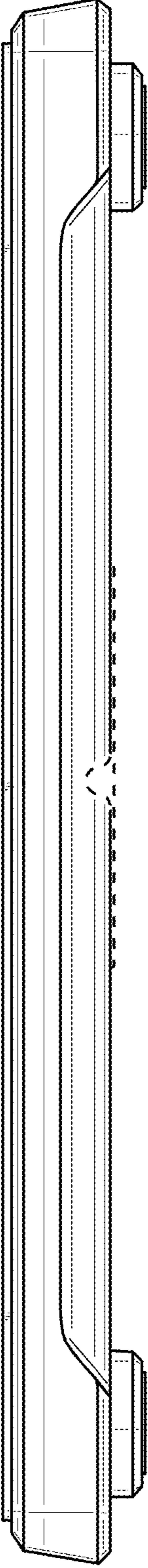


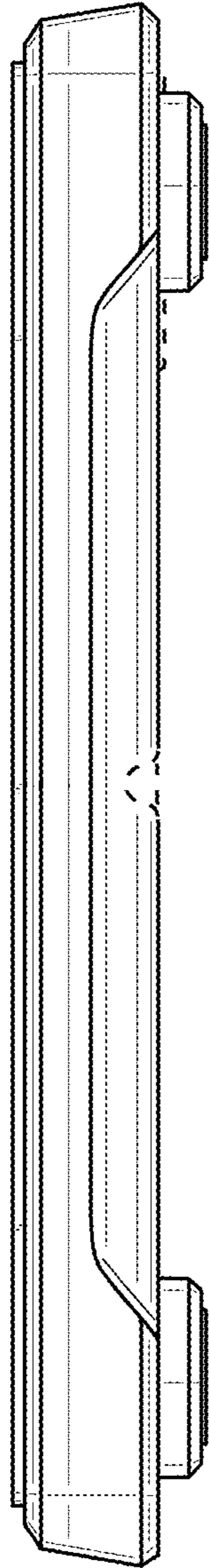
FIG. 9



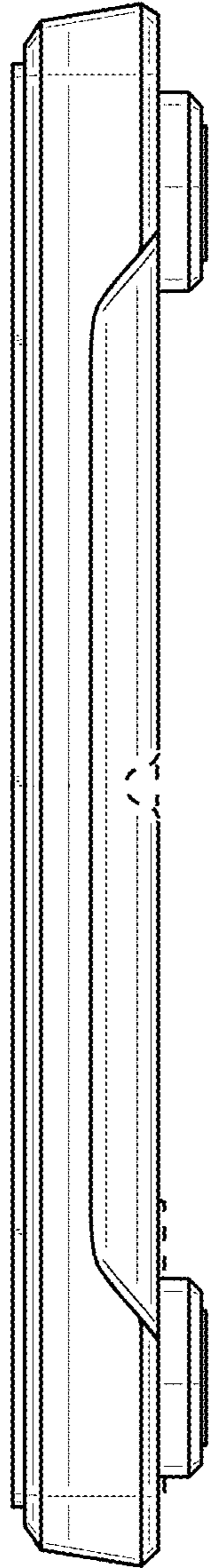
**FIG. 10**



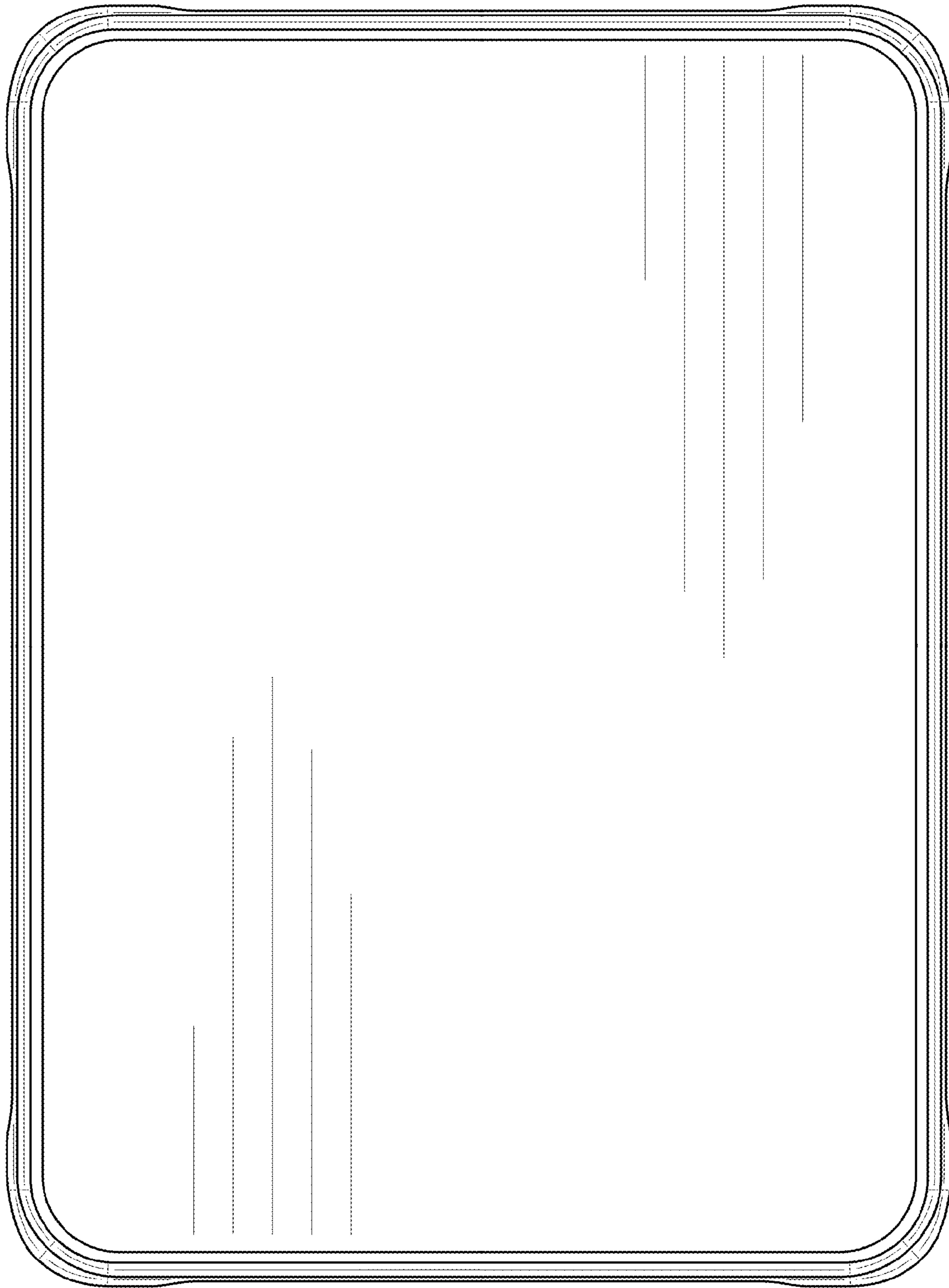
**FIG. 11**



**FIG. 12**

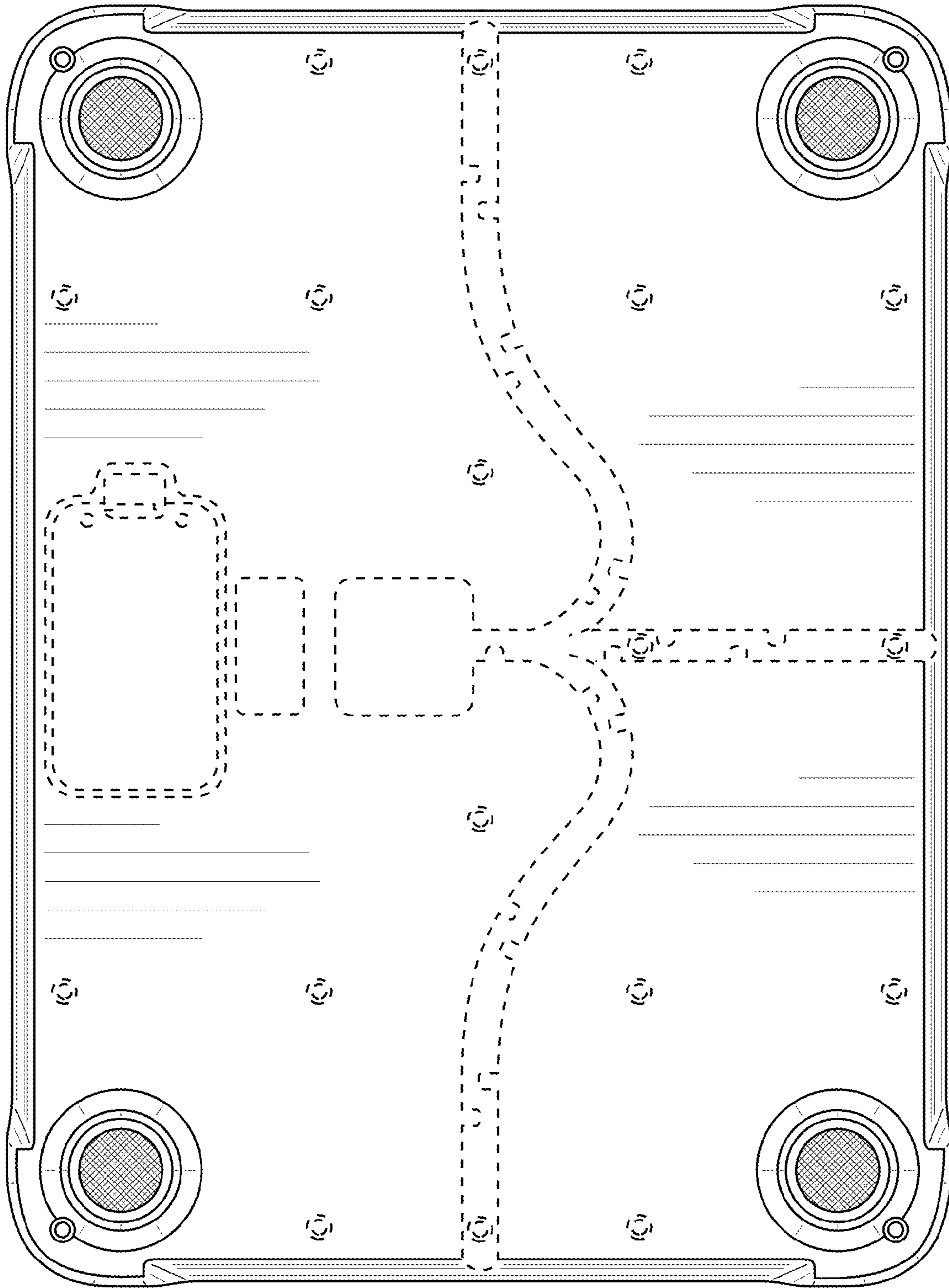


**FIG. 13**



**FIG. 14**





**FIG. 15**