



US00D955135S

(12) **United States Design Patent** (10) **Patent No.:** **US D955,135 S**
Huang (45) **Date of Patent:** **** Jun. 21, 2022**

(54) **CUP HOLDER**

FOREIGN PATENT DOCUMENTS

(71) Applicant: **Jian Huang**, Shenzhen (CN)

CN 305430682 * 11/2019
CN 305741135 * 4/2020

(72) Inventor: **Jian Huang**, Shenzhen (CN)

(**) Term: **15 Years**

OTHER PUBLICATIONS

(21) Appl. No.: **29/730,729**

(22) Filed: **Apr. 8, 2020**

Living Room Couch Cup Holder for Sofa Drink Holder and Tray Armrest Coffee Tea Silicone Water Cup Holder Couch Coaster. OOTDTY. (online) 6 pages. Posted Nov. 2021. [Retrieved Nov. 9, 2021] <https://www.aliexpress.com/item/1005002702381230.html> (Year: 2021).*

(51) **LOC (13) Cl.** **06-04**

(52) **U.S. Cl.**
USPC **D6/535**; D7/619.1; D7/624.1

(58) **Field of Classification Search**
USPC D7/619.1, 619.2, 620, 624.1, 624.4, 601;
D6/512, 552, 553, 535; D24/199, 415,
D24/416, 400; D12/411, 416, 400
CPC A47C 7/62; A24F 19/007; B60R 7/043;
B60N 2/4673; A47G 23/03; F17C 13/001;
B65D 81/3886

Ugotfeels Cup Holder for Sofa,Couch Holder Fits Wine Glasses, Mugs, Cups, Flasks, Tumblers and Cans on Couch. Ugotfeels (online) 7 pages. Posted Mar. 29, 2021. [Retr. Nov. 9, 2021]. <https://www.amazon.com/Ugotfeels-Glasses-Tumblers-Silicone-Non-Toxic/dp/B091B2LRC> (Year: 2021).*

(Continued)

See application file for complete search history.

Primary Examiner — Marie D. Fast Horse
Assistant Examiner — Jennifer Sierra Yosinski

(56) **References Cited**

(57) **CLAIM**

U.S. PATENT DOCUMENTS

The ornamental design for a cup holder, as shown and described.

- 4,195,880 A * 4/1980 Henkhaus A47C 7/624
297/188.18
- D337,027 S * 7/1993 Malatok D7/507
- D458,084 S * 6/2002 Hudson D7/553.4
- D489,453 S * 5/2004 Sapyta D24/122
- D604,564 S * 11/2009 Walter D7/620
- D637,460 S * 5/2011 Tussy D7/624.1
- D789,157 S * 6/2017 Esposito D7/624.2
- D795,022 S * 8/2017 Freeder D7/620
- D869,910 S * 12/2019 Ye D7/619.1
- D906,220 S * 12/2020 Milhoan D12/221
- D937,637 S * 12/2021 Xiang D7/619.1
- 2001/0032791 A1 * 10/2001 Hudson A47G 23/02
206/217
- 2012/0086245 A1 * 4/2012 Nelson A47C 7/624
297/188.18

DESCRIPTION

FIG. 1 is a front perspective view of a cup holder showing my new design;
FIG. 2 is a front elevation view thereof;
FIG. 3 is a rear elevation view thereof;
FIG. 4 is a left side elevation view thereof;
FIG. 5 is a right side elevation view thereof;
FIG. 6 is a top plan view thereof; and,
FIG. 7 is a bottom plan view thereof.

1 Claim, 7 Drawing Sheets

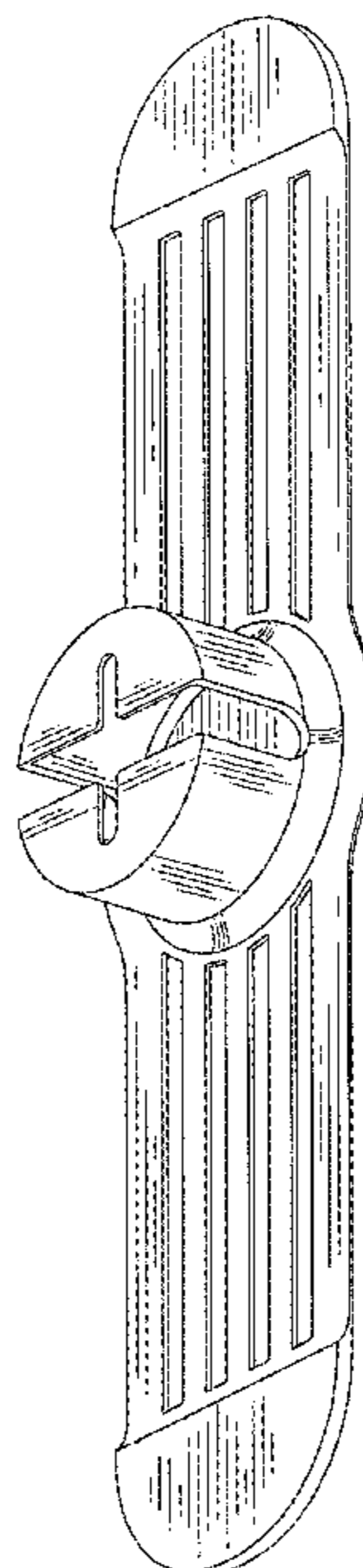

(56)

References Cited

OTHER PUBLICATIONS

Couch Cup Holder by MikaaMaxx—This Ultimate Drink Holder is Uniquely Designed to fit Any Beverage Shape and Works with All Standard Sofa arms. MikaaMaxx (online) 7 pages. Posted Sep. 6, 2021. [Retr. Nov. 9, 2021]. <https://www.amazon.com/Couch-Cup-Holder-MikaaMaxx-Ultimate/dp/B0947H281R/> (Year: 2021).*

Anti-Spill Sofa Cup Holder Couch Coaster Holder Food Grade Silicone Drink Holder for Sofa Couch Car Cup Holder. LifeStar Store (online) 4 pages. Posted Sep. 2020. [Retr. Nov. 9, 2021]. <https://www.aliexpress.com/i/4000291033244.html> (Year: 2020).*

CouchCoaster—The Ultimate Drink Holder for Your Sofa. Hit Products (online) 20 pages. Posted Dec. 10, 2016. [Retr. Nov. 9, 2021] <https://www.amazon.com/CouchCoaster-Ultimate-Drink-Holder-Steel/dp/B01BX0VHZ2/?th=1> (Year: 2016).*

Balanced Beverage Drink Holder. QVC (online) 7 pages. Posted Oct. 3, 2021. [Retrieved Nov. 9, 2021]. <https://www.qvc.com/Balanced-Beverage-Drink-Holder.product.K50552.html> (Year: 2021).*

* cited by examiner

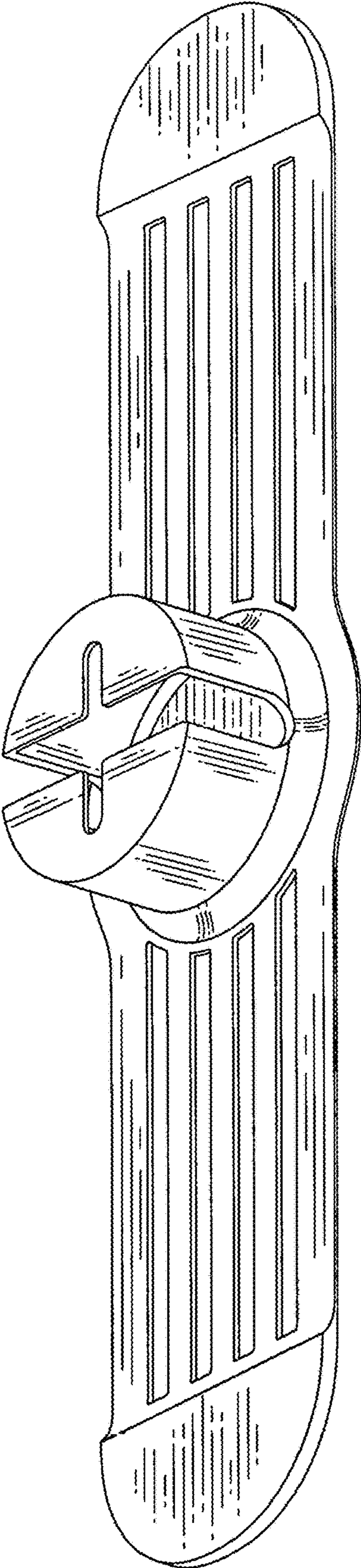

FIG. 1

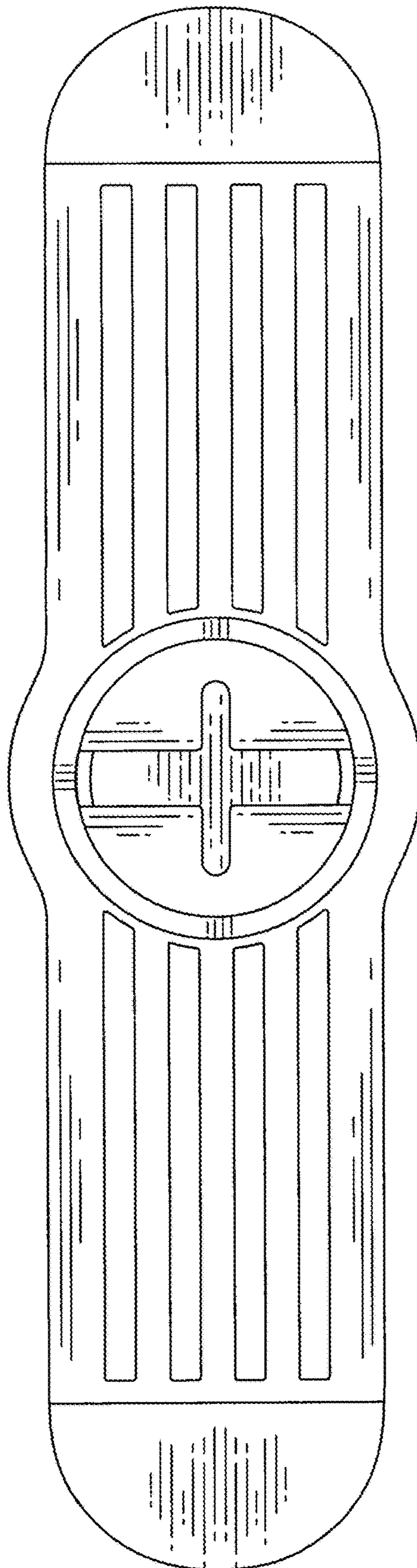

FIG. 2

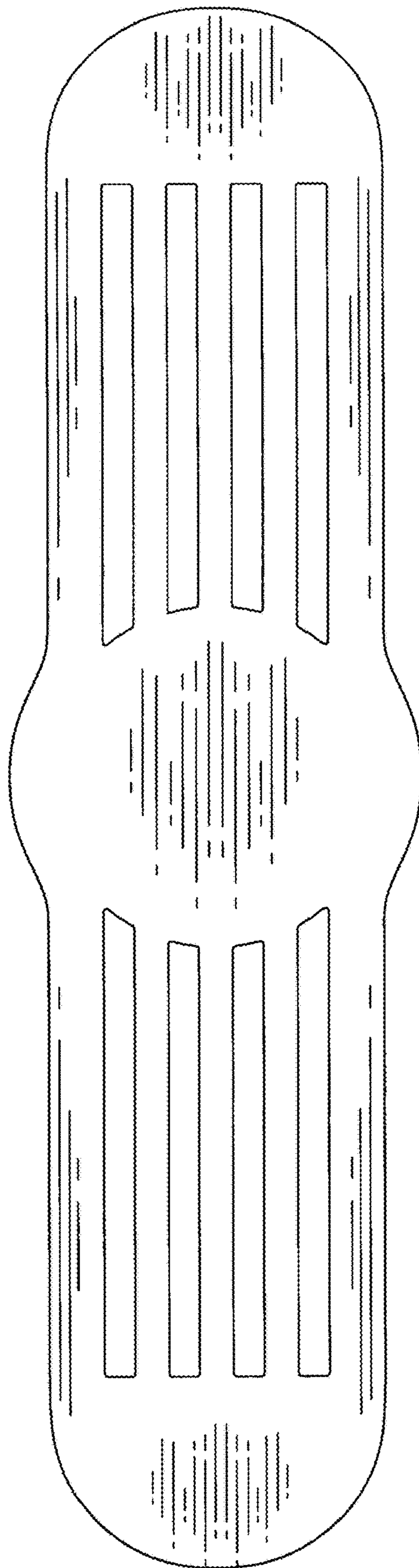

FIG. 3

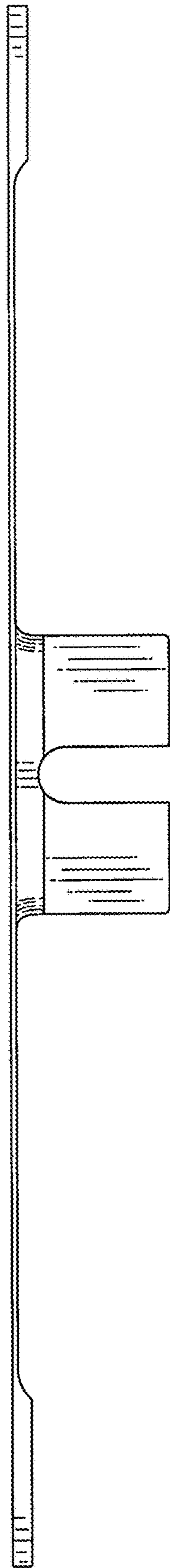

FIG. 4

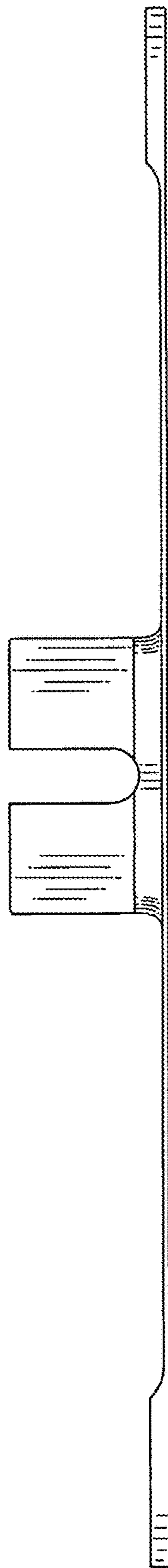

FIG. 5

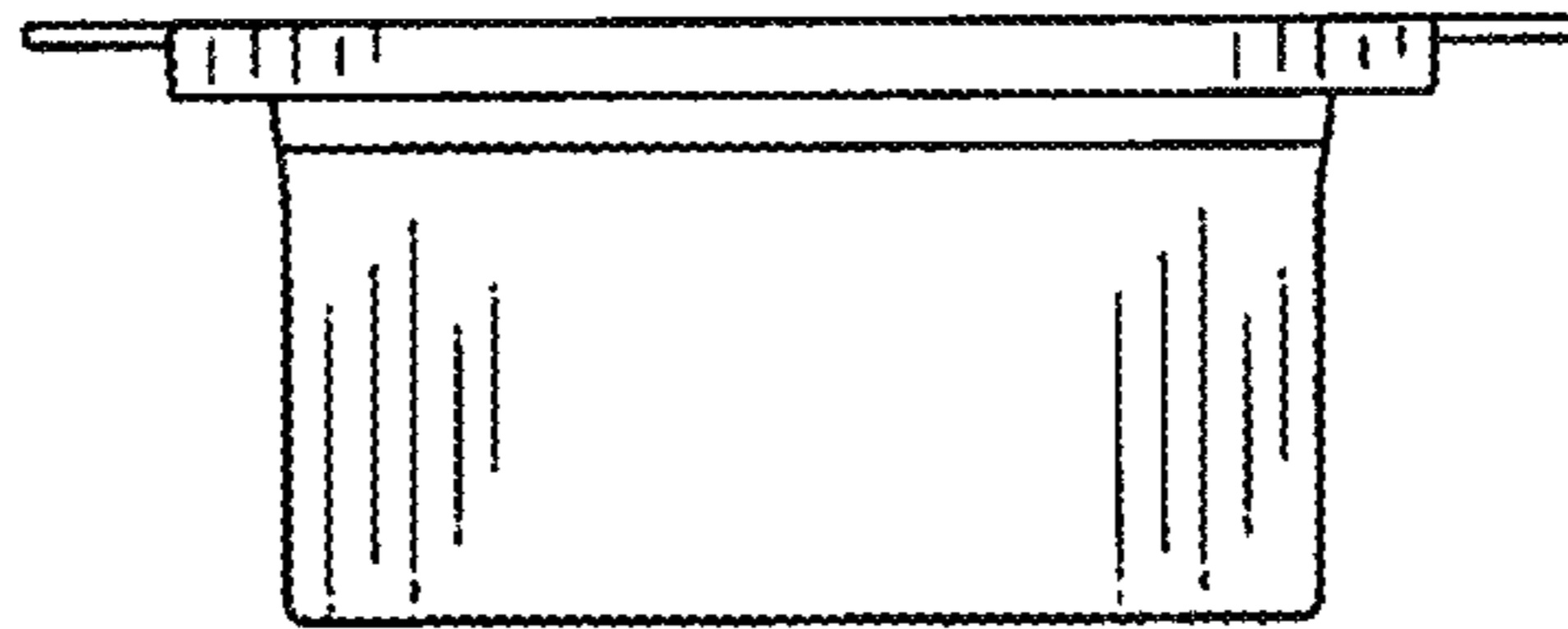

FIG. 6

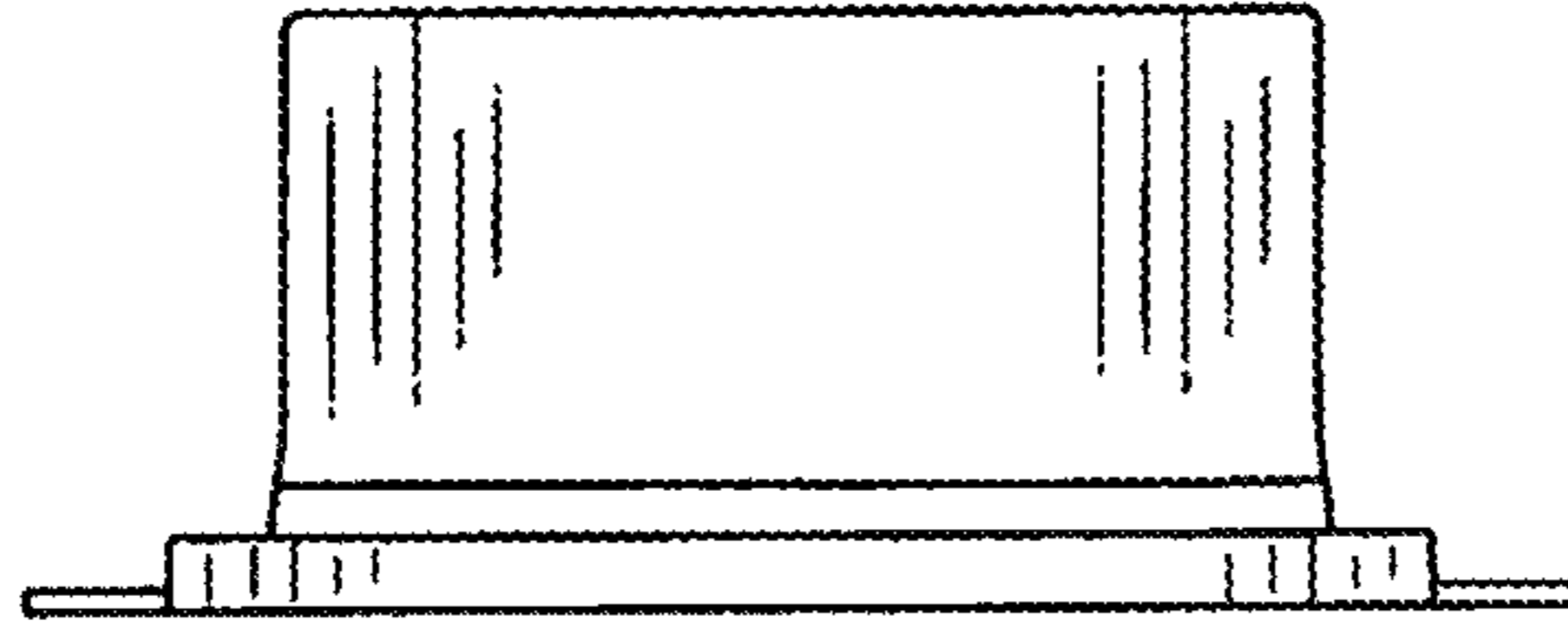

FIG. 7