



US00D955133S

(12) **United States Design Patent**
Changsurra

(10) **Patent No.:** **US D955,133 S**
(45) **Date of Patent:** **** Jun. 21, 2022**

(54) **CHAIR**

(71) Applicant: **VINCENT SHEPPARD N.V.**, Spiere (BE)

(72) Inventor: **Janwit Changsurra**, Ghent (BE)

(73) Assignee: **VINCENT SHEPPARD N.V.**

(**) Term: **15 Years**

(21) Appl. No.: **29/764,963**

(22) Filed: **Jan. 5, 2021**

(30) **Foreign Application Priority Data**

Nov. 12, 2020 (EM) 008266969-0001

(51) **LOC (13) Cl.** **06-01**

(52) **U.S. Cl.**
USPC **D6/379**

(58) **Field of Classification Search**

USPC D6/369, 370, 379, 375, 372, 716.4, 371, D6/374, 334, 381, 717, 360, 380, 716
CPC A47C 1/124; A47C 3/025; A47C 3/18; A47C 3/12; A47C 3/34; A47C 4/028; A47C 4/02; A47C 5/12; A47C 5/125; A47C 5/02; A47C 5/06; A47C 5/08; A47C 7/445; A47C 7/443; A47C 7/60; A47C 7/506; A47C 9/007; A47C 13/005; A47C 13/023; A47C 31/003; A47C 31/008; A47C 31/113; A47C 31/02; A47B 85/04; B60R 2/0284; B60R 2/062; B60R 22/001; B60R 22/24; B60R 22/28; B60R 22/58; B60R 22/64; B60R 22/68; B60R 22/80; B60R 22/99; B60R 22/245; B60R 22/643; B60R 22/646; B60R 22/665; B60R 22/686; B60R 22/688; B60R 22/803; B60R 22/986; B60R 22/914; B60R 22/995

See application file for complete search history.

(56) **References Cited**

U.S. PATENT DOCUMENTS

D183,618	S	*	9/1958	Kofod-Larsen	D6/379
D193,842	S	*	10/1962	Ohlsson	D6/379
D193,843	S	*	10/1962	Ohlsson	D6/379
D204,451	S	*	4/1966	Straits	297/411.43
7,152,929	B2	*	12/2006	Wu	A47C 31/02 297/452.56
D573,363	S	*	7/2008	Pillet	D6/375
D573,818	S	*	7/2008	Su	D6/366
7,406,733	B2	*	8/2008	Coffield	A47C 7/282 297/452.56
D648,557	S	*	11/2011	Frinier	D6/369
D656,336	S	*	3/2012	Neil	D6/379
D686,010	S	*	7/2013	Cramer	D6/379
D807,073	S	*	1/2018	Neil	D6/379
D822,418	S	*	7/2018	Swy	D6/709.2
D885,780	S	*	6/2020	Oakley	D6/374
D891,127	S	*	7/2020	Krusin	D6/334

* cited by examiner

Primary Examiner — Kevin K Rudzinski
Assistant Examiner — Paul D Bohannon
(74) *Attorney, Agent, or Firm* — Fresh IP PLC; Clifford D. Hyra; Micah C. Gunn

(57) **CLAIM**

The ornamental design for a chair, as shown and described.

DESCRIPTION

FIG. 1 is a top, right perspective view of a chair;
FIG. 2 is a top, left perspective view thereof;
FIG. 3 is a bottom, right perspective view thereof;
FIG. 4 is a bottom, left perspective view thereof;
FIG. 5 is a front view thereof;
FIG. 6 is a rear view thereof;
FIG. 7 is a right-side view thereof;
FIG. 8 is a left-side view thereof;
FIG. 9 is a top view thereof; and,
FIG. 10 is a bottom view thereof.

1 Claim, 10 Drawing Sheets

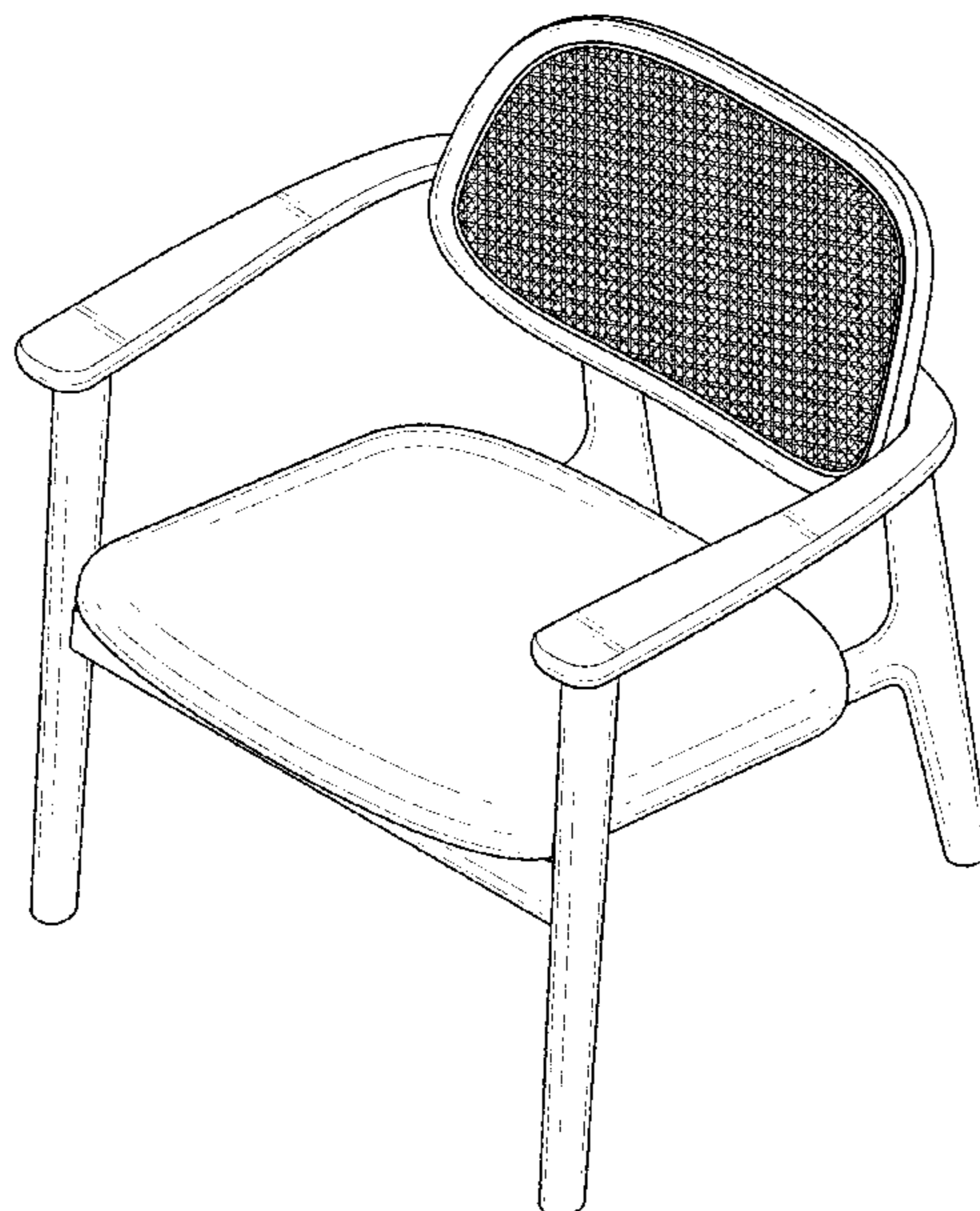

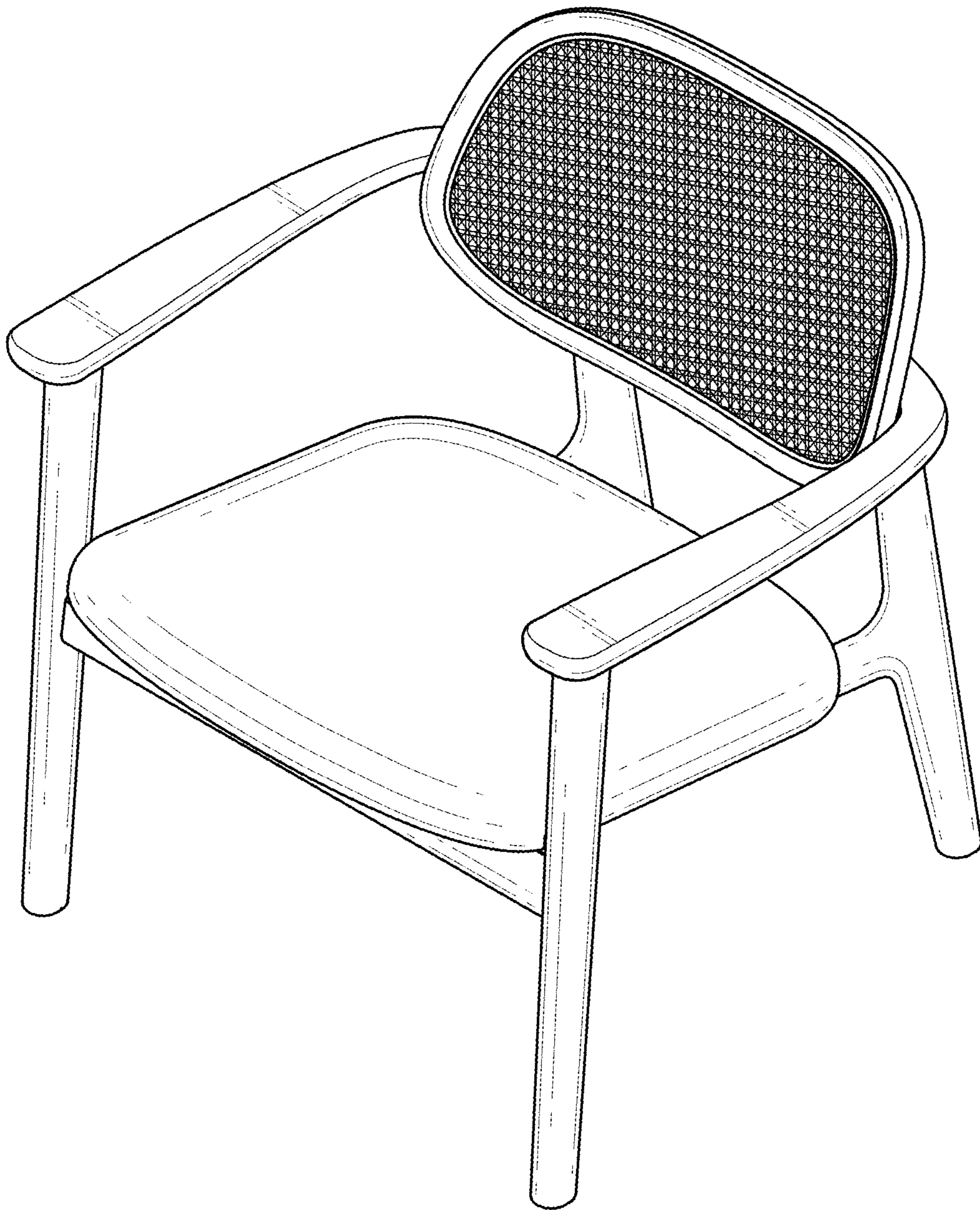

FIG. 1

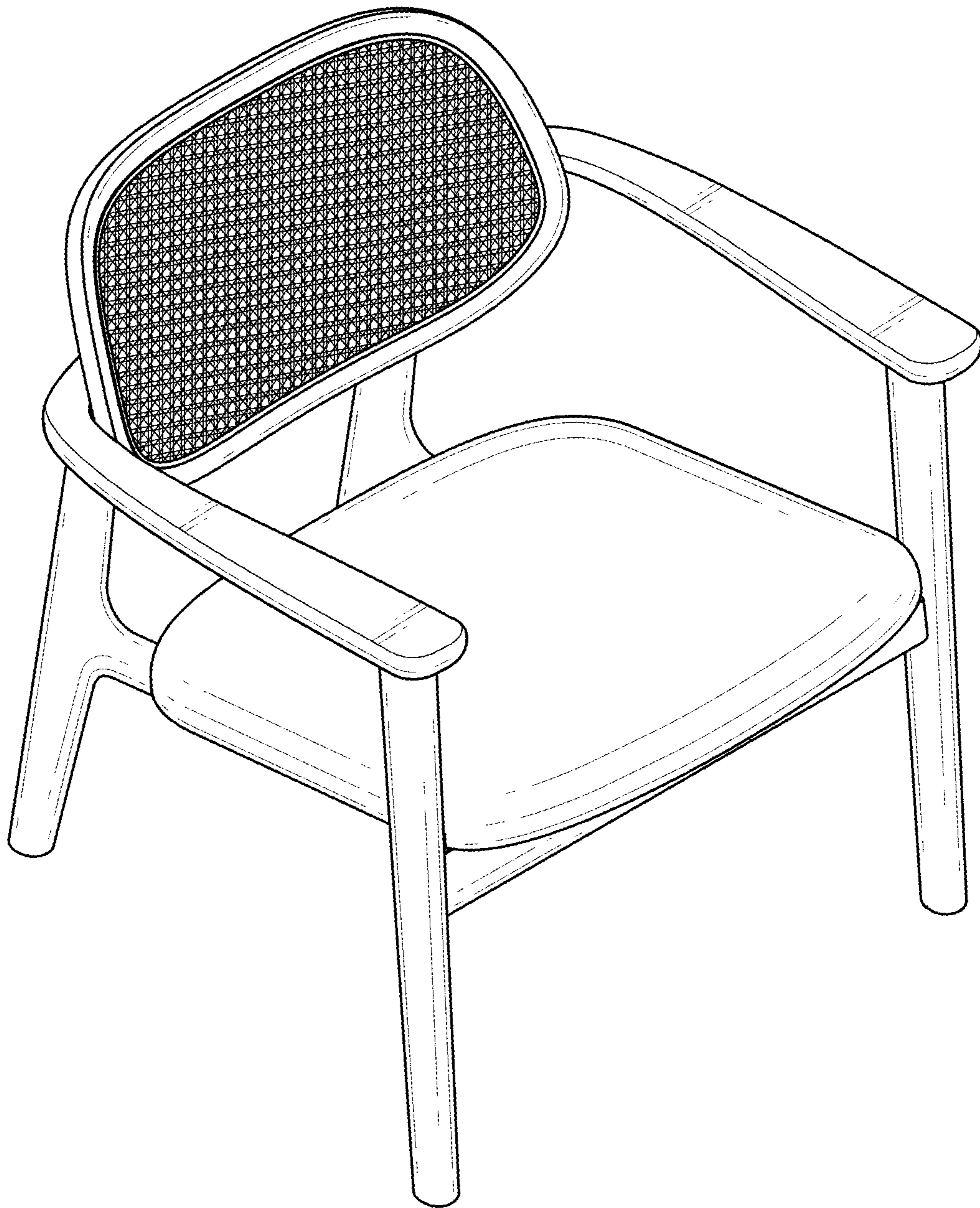

FIG. 2

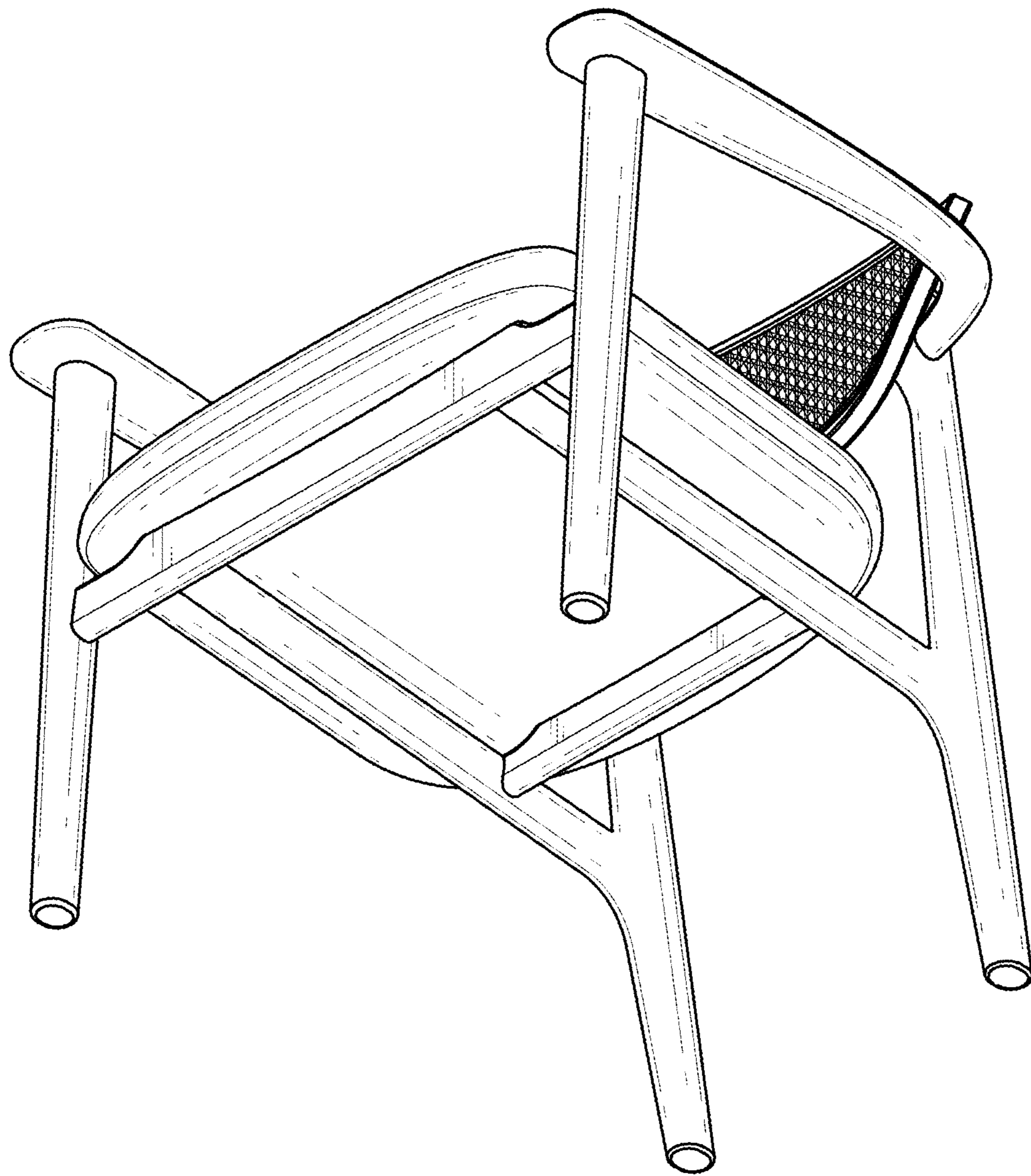

FIG. 3

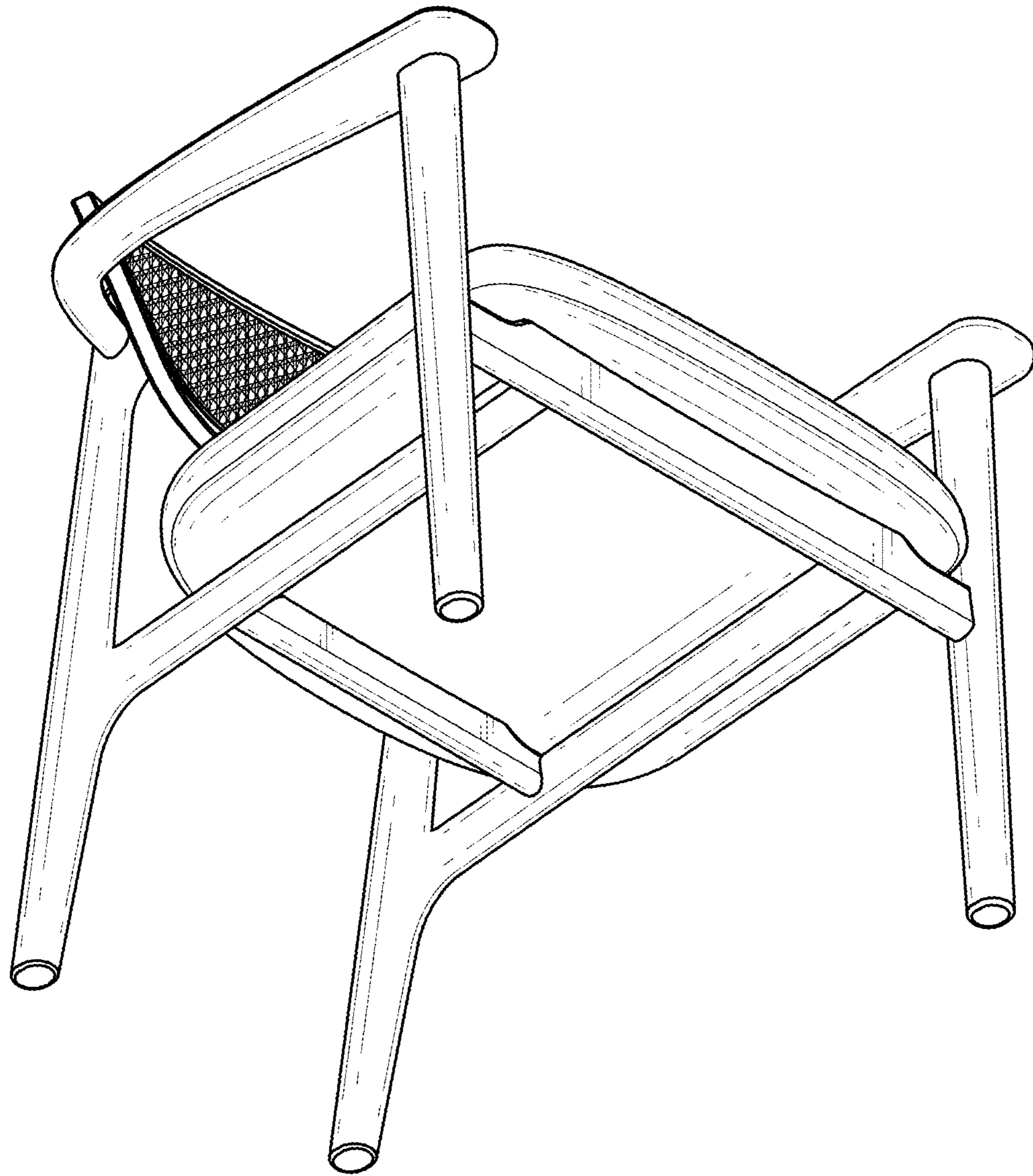

FIG. 4

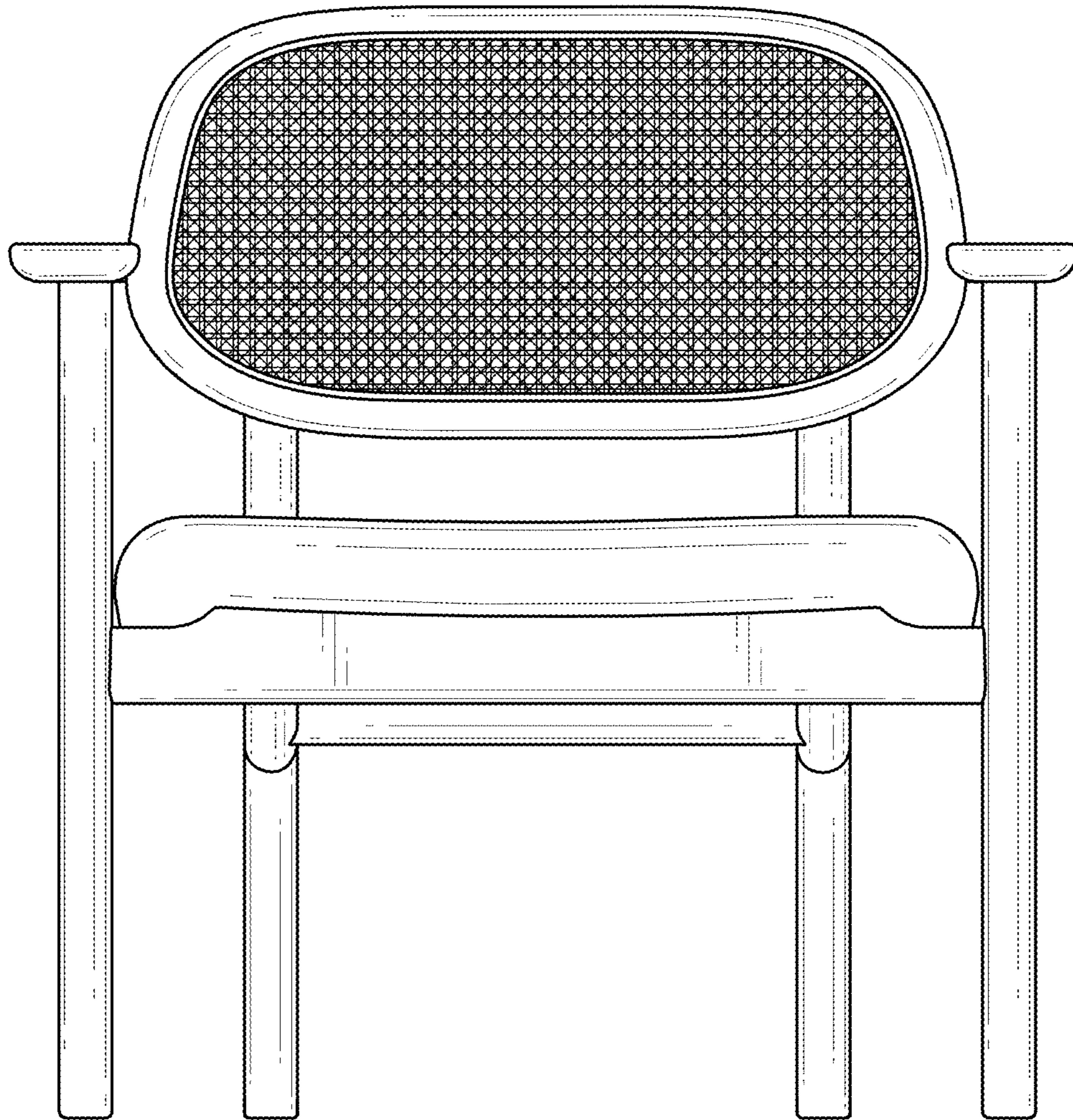

FIG. 5

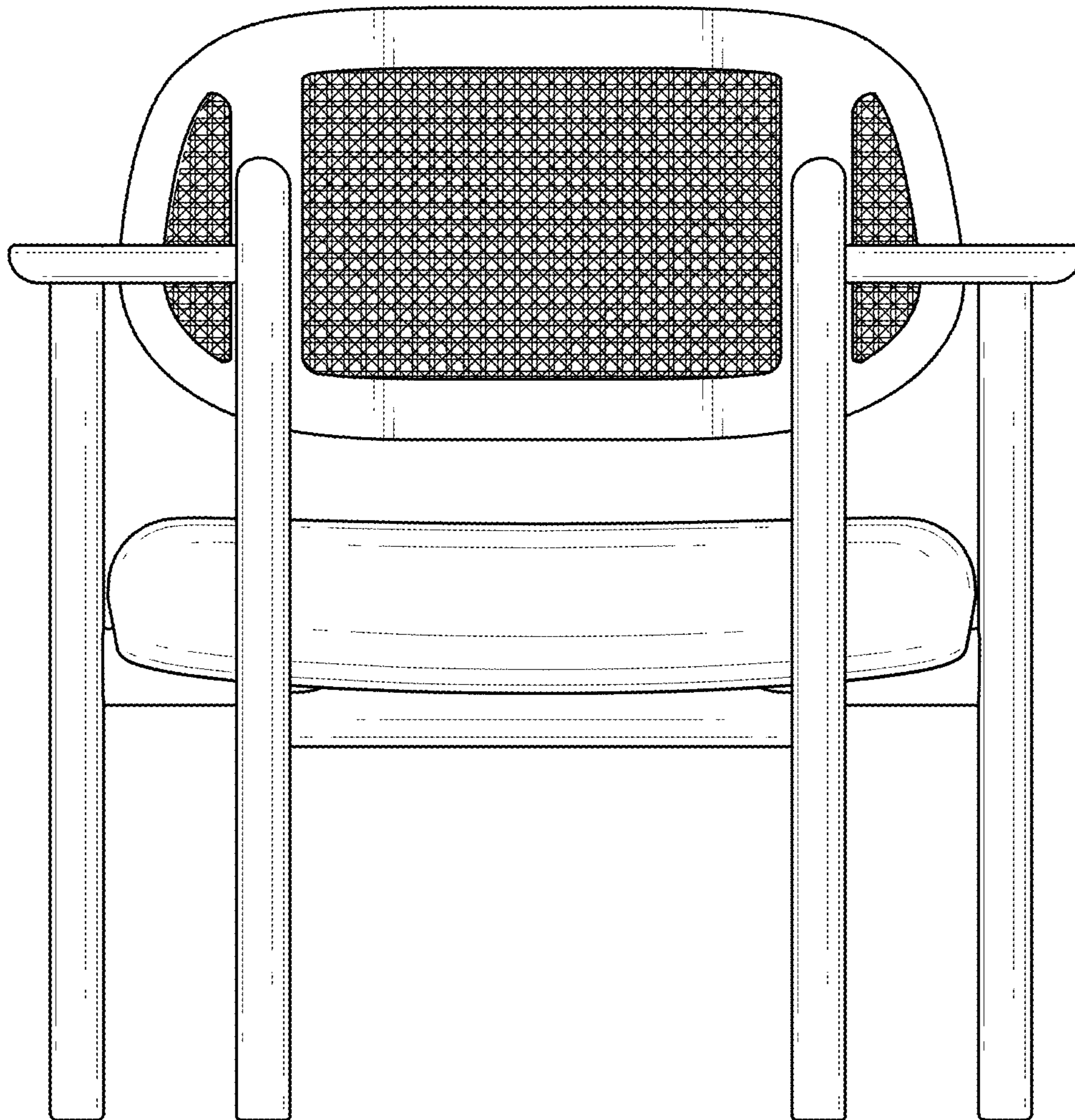

FIG. 6

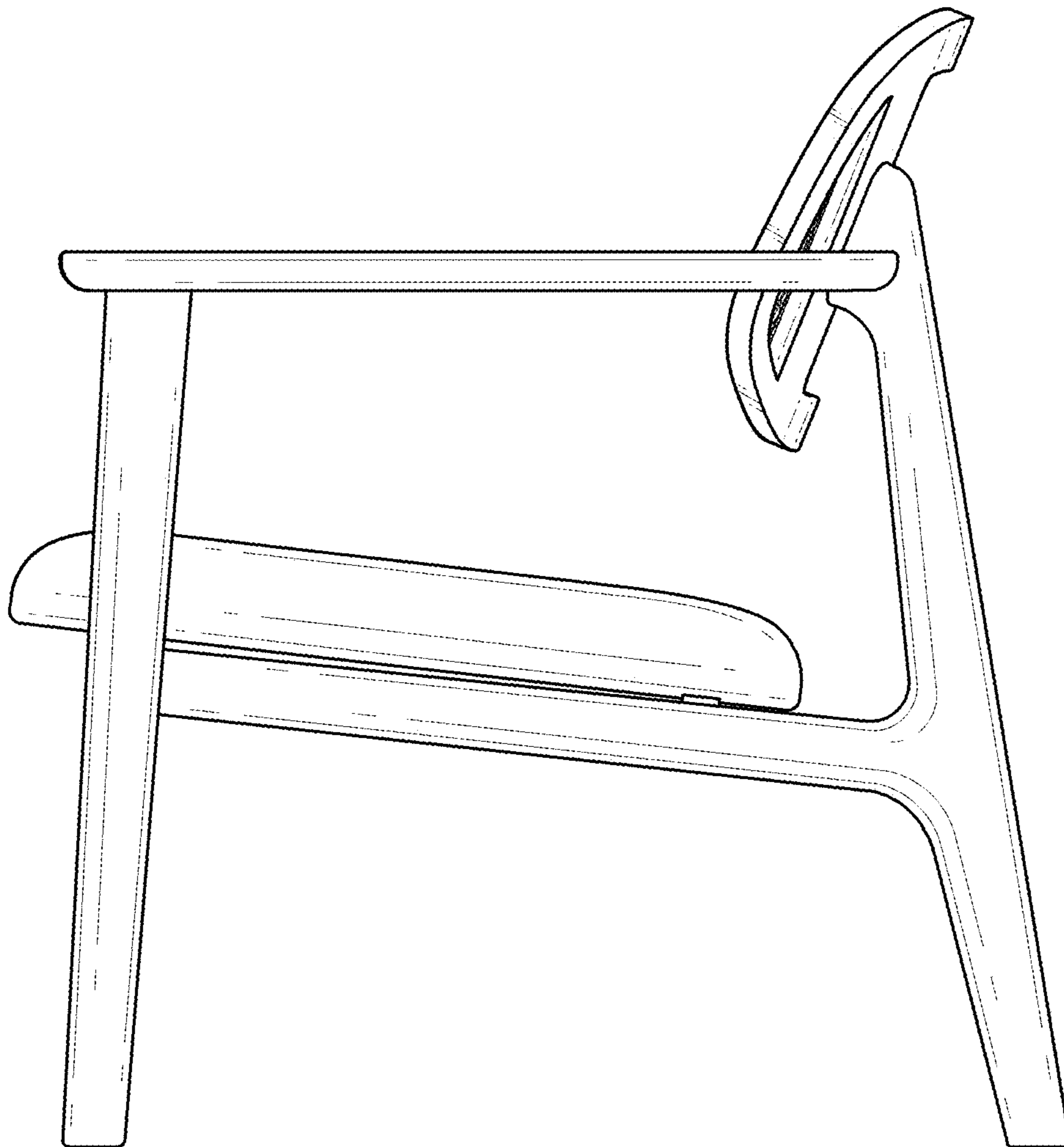

FIG. 7

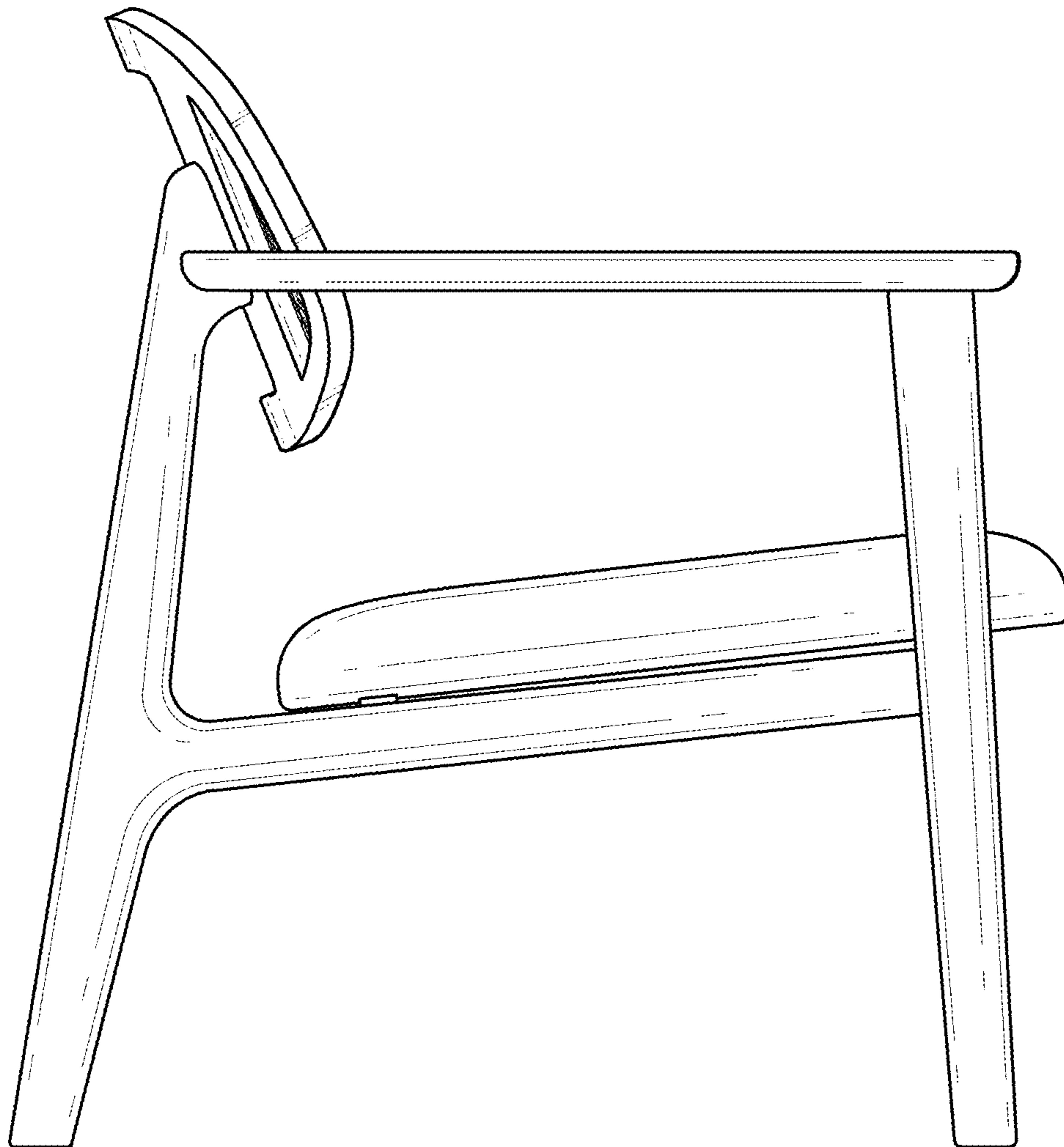

FIG. 8

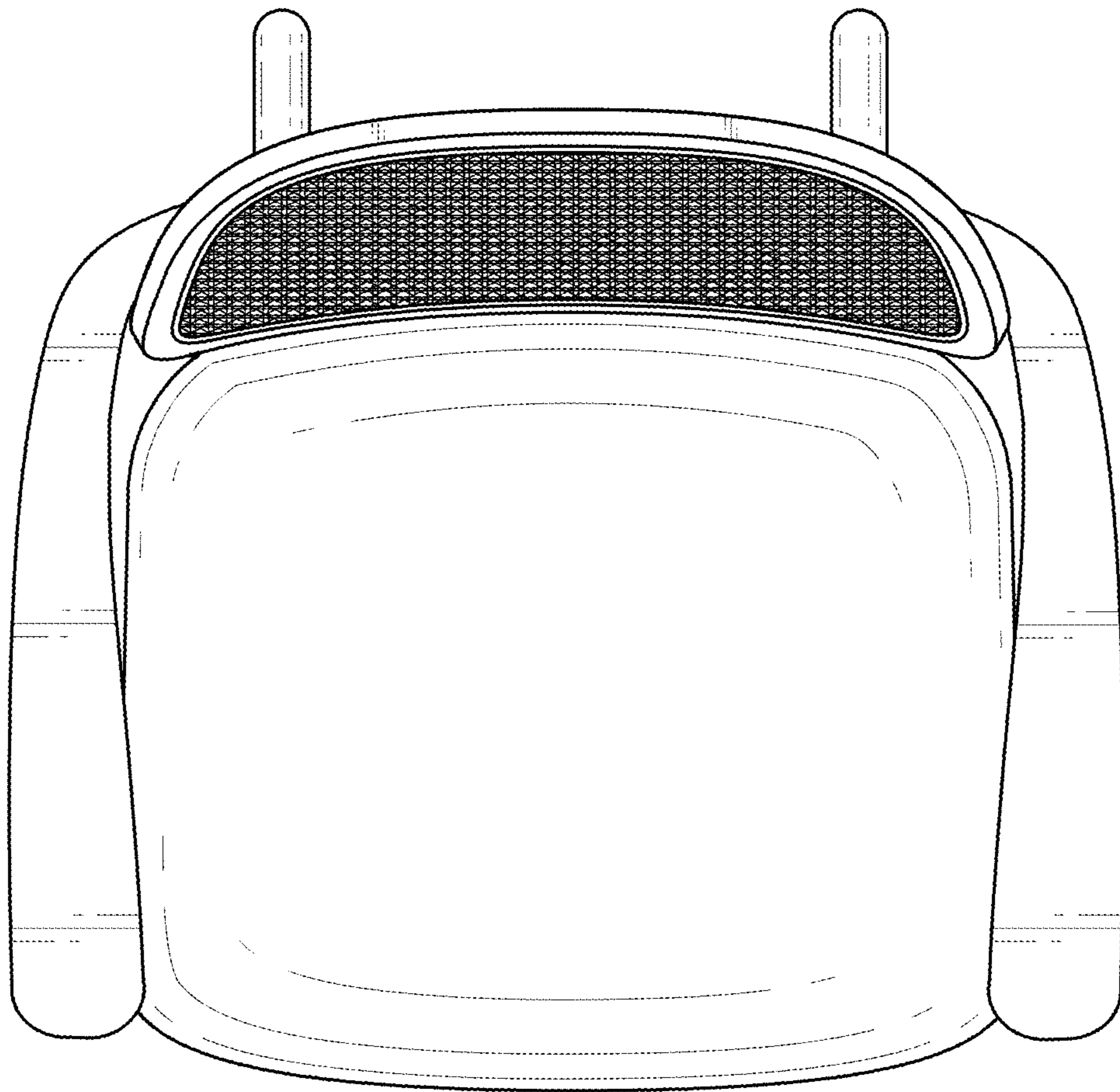

FIG. 9

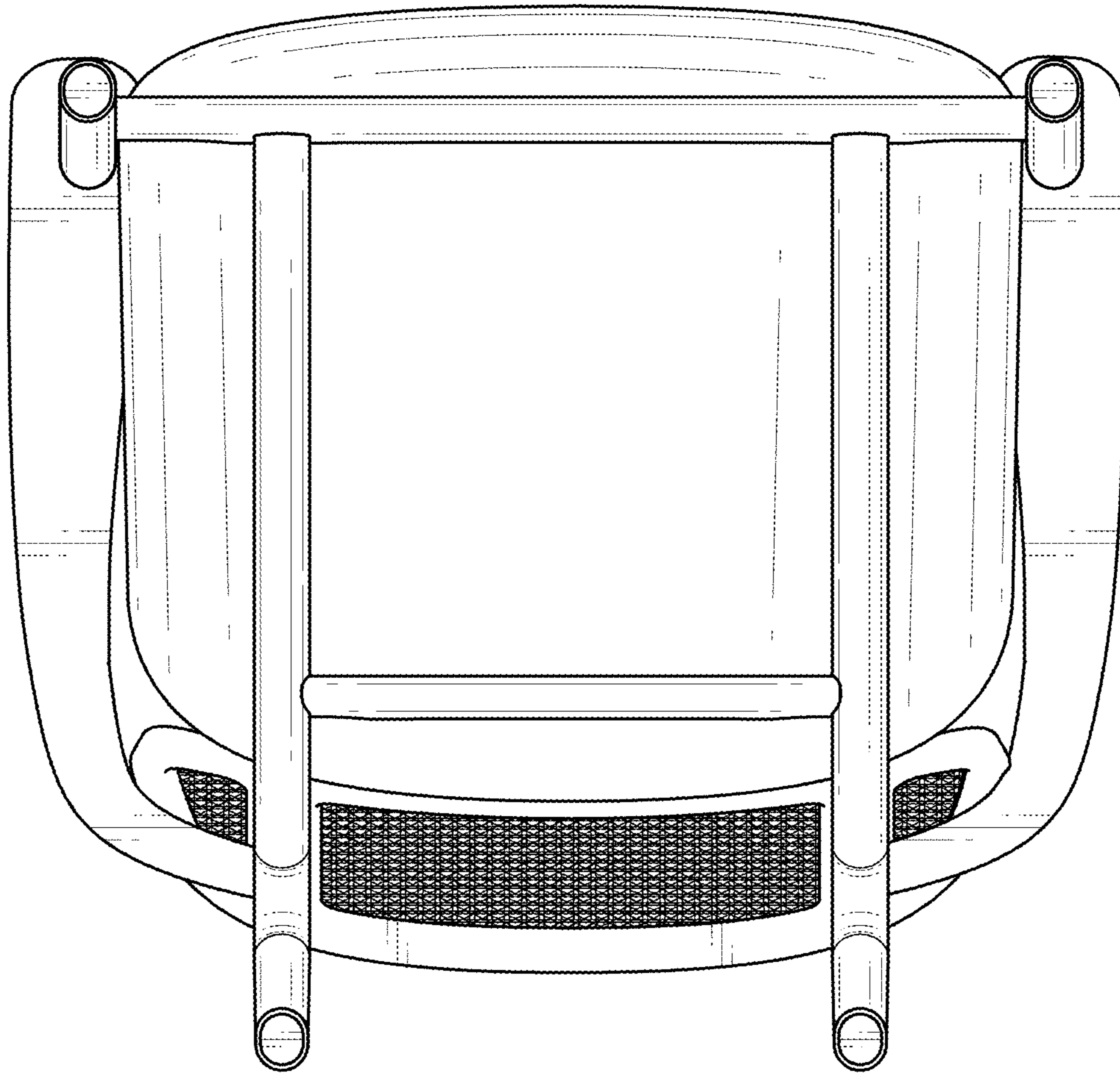

FIG. 10