



US00D955072S

(12) **United States Design Patent**
Lewenhaupt Sandberg et al.

(10) **Patent No.: US D955,072 S**
(45) **Date of Patent: ** Jun. 14, 2022**

- (54) **STEAM IRON**
- (71) Applicant: **Steamery AB**, Stockholm (SE)
- (72) Inventors: **Frej Lewenhaupt Sandberg**, Stockholm (SE); **Yanjie Wang**, Stockholm (SE); **Qian Jiang**, Stockholm (SE); **Johan Frössén**, Stockholm (SE)
- (73) Assignee: **STEAMERY AB**, Stockholm (SE)
- (**) Term: **15 Years**
- (21) Appl. No.: **29/745,507**
- (22) Filed: **Aug. 6, 2020**

D663,909 S *	7/2012	Andreesen	D32/17
8,275,248 B2 *	9/2012	Xu	D06F 75/12
				392/394
8,510,909 B2 *	8/2013	Spatz	D06F 73/00
				15/405
8,806,786 B2 *	8/2014	Jiang	D06F 73/00
				38/75
9,567,705 B2 *	2/2017	Chua	D06F 75/30
9,745,691 B2 *	8/2017	Date	A47L 11/34
D826,492 S *	8/2018	Huang	D32/17
D842,559 S *	3/2019	Yang	D32/17
10,287,726 B2 *	5/2019	Chua	D06F 75/00
D857,313 S *	8/2019	Smith	D32/17
10,407,819 B2 *	9/2019	Chua	D06F 73/00
10,612,185 B2 *	4/2020	Javit	D06F 87/00
10,689,795 B2 *	6/2020	Yan	D06F 75/20

(Continued)

- (30) **Foreign Application Priority Data**
- Feb. 7, 2020 (CN) 202030048031.0
- Feb. 7, 2020 (EM) 007672225-0001
- (51) **LOC (13) Cl.** **15-05**
- (52) **U.S. Cl.**
- USPC **D32/17**
- (58) **Field of Classification Search**
- USPC D32/17, 18, 21, 22, 23, 24, 31, 32, 33, D32/34
- CPC A47L 11/34; A47L 11/40; A47L 11/4016; A47L 5/24; A47L 5/28; D06F 75/10; D06F 75/12; D06F 75/16; D06F 75/20; D06F 75/30; D06F 73/00; D06F 87/00; D06M 11/34
- See application file for complete search history.

- (56) **References Cited**
- U.S. PATENT DOCUMENTS
- D576,363 S * 9/2008 Reiner D32/17
- D592,365 S * 5/2009 Massip D32/17
- D622,457 S * 8/2010 Choi D32/17
- D646,029 S * 9/2011 Choi D32/17

OTHER PUBLICATIONS

How to Use Cirrus No. 3 Iron Steamer (on-line), dated Sep. 26, 2021. Retrieved from Internet Nov. 4, 2021, URL: <https://www.youtube.com/watch?v=xtySXI9eTo> (1 page) (Year: 2021).*

Primary Examiner — Kimberly Barnes
(74) *Attorney, Agent, or Firm* — Faegre Drinker Biddle & Reath LLP

(57) **CLAIM**
The ornamental design for a steam iron, as shown and described.

DESCRIPTION

FIG. 1 is a rear perspective view of a steam iron, illustrating our new design;
FIG. 2 is a front view thereof;
FIG. 3 is a rear view thereof;
FIG. 4 is a left side view thereof;
FIG. 5 is a right side view thereof;
FIG. 6 is a top view thereof; and,
FIG. 7 is a bottom view thereof.

1 Claim, 7 Drawing Sheets

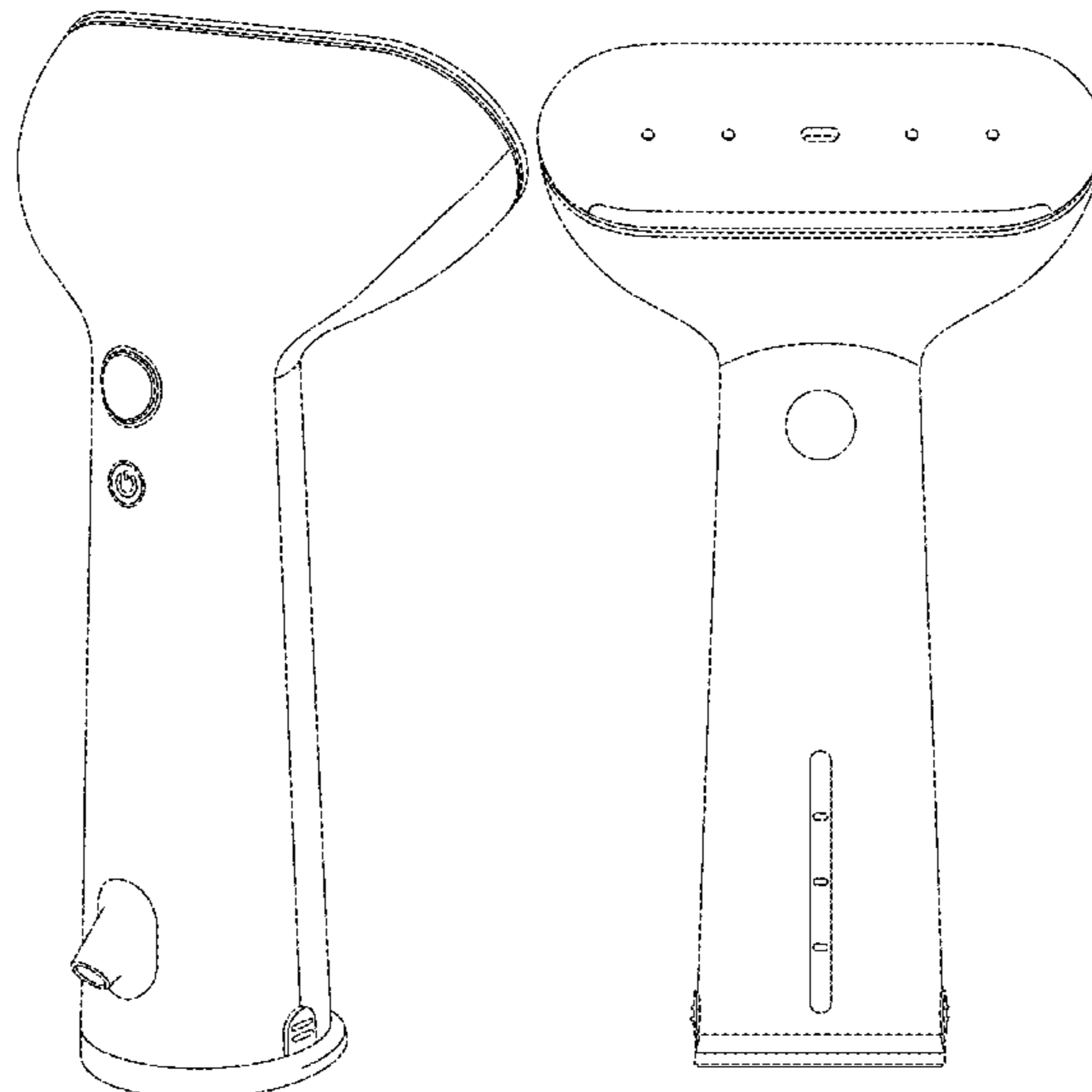

(56)

References Cited

U.S. PATENT DOCUMENTS

10,845,772 B2 * 11/2020 Yang D06F 75/14
D915,696 S * 4/2021 Huang D32/17
D920,606 S * 5/2021 Huang D32/17
D921,305 S * 6/2021 Zhu D32/17
D923,262 S * 6/2021 Li D32/17
D925,151 S * 7/2021 Park D32/70
D930,925 S * 9/2021 Wong D32/17
2017/0241068 A1 * 8/2017 Lee D06F 73/00
2021/0277590 A1 * 9/2021 Lai D06F 73/00

* cited by examiner

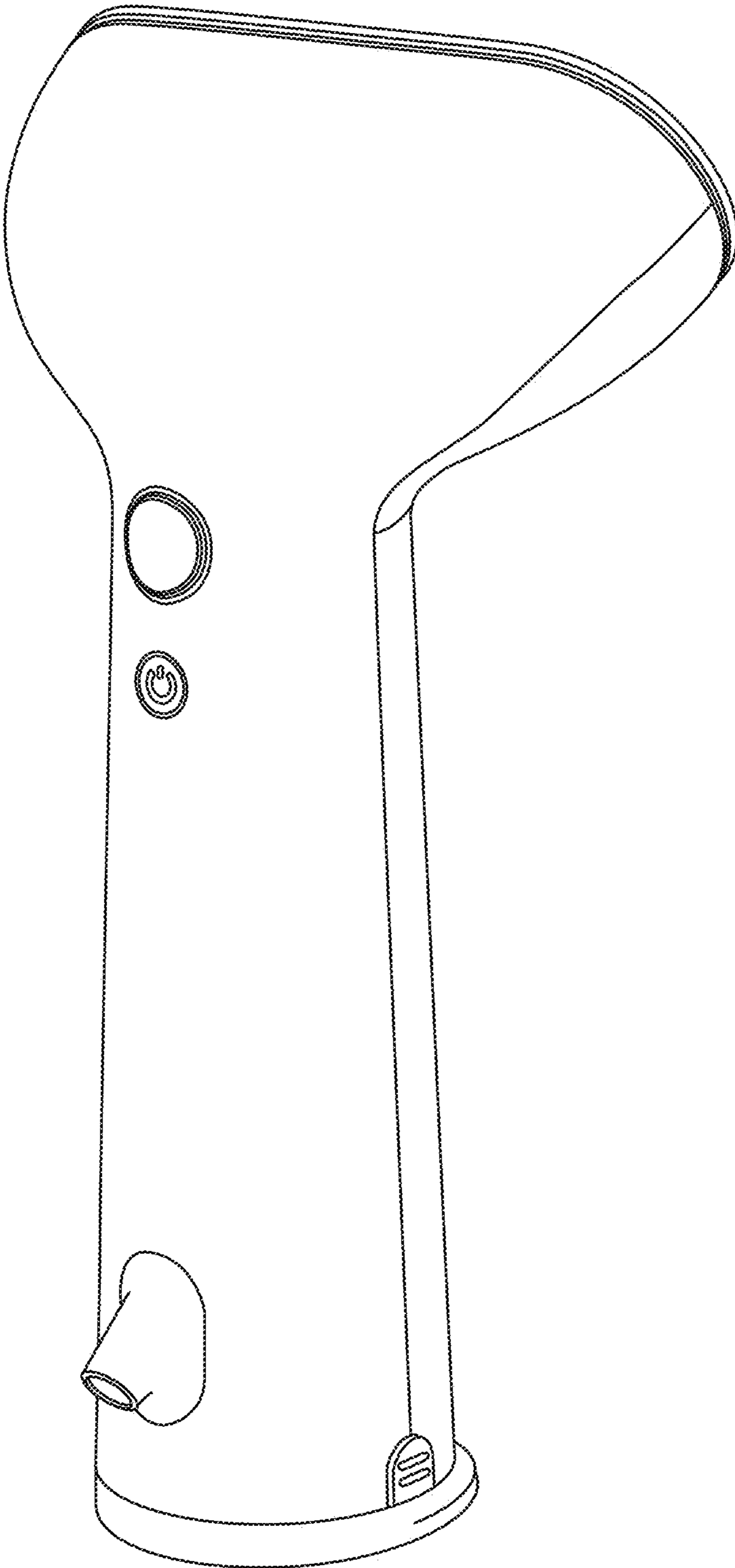

FIG. 1

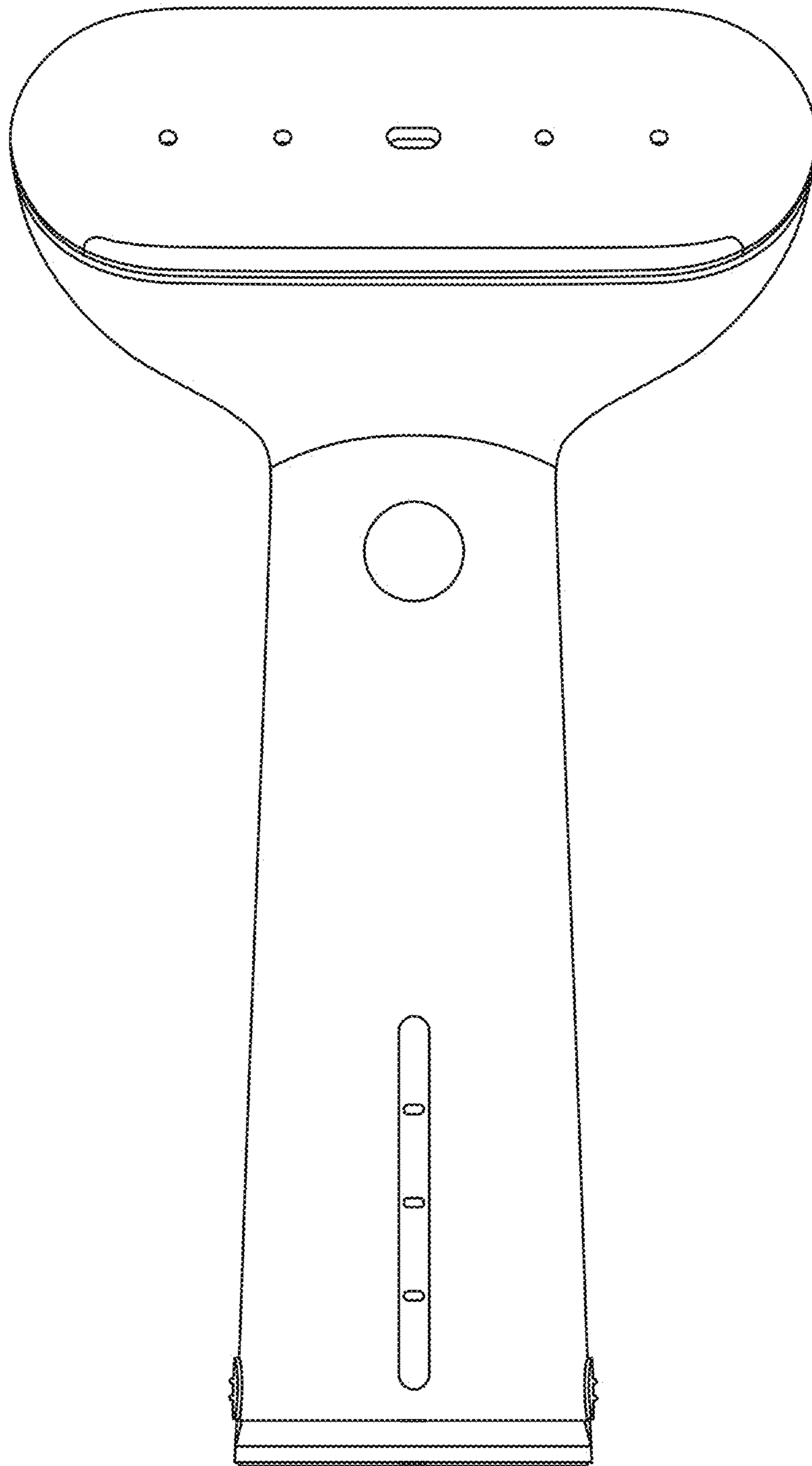

FIG. 2

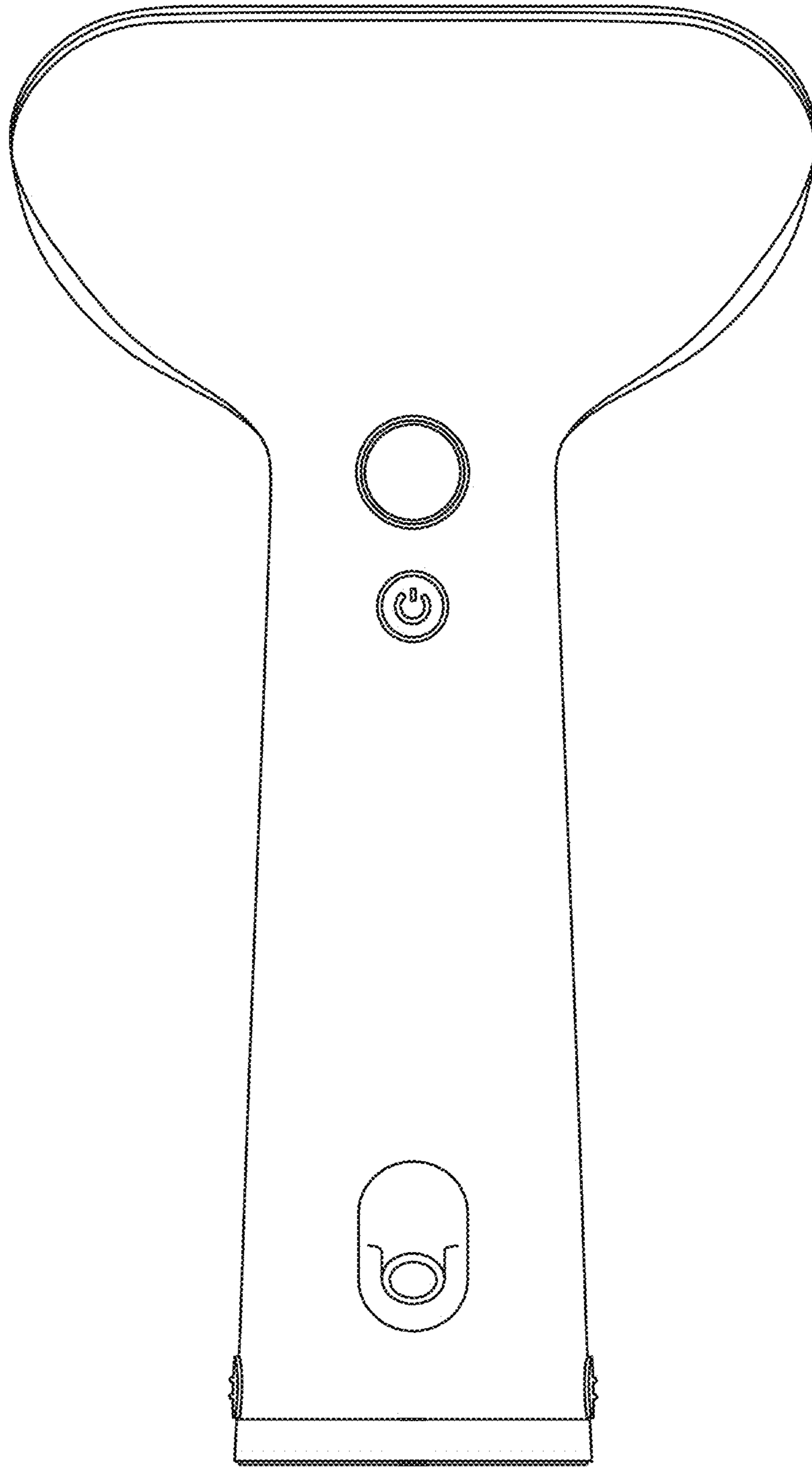

FIG. 3

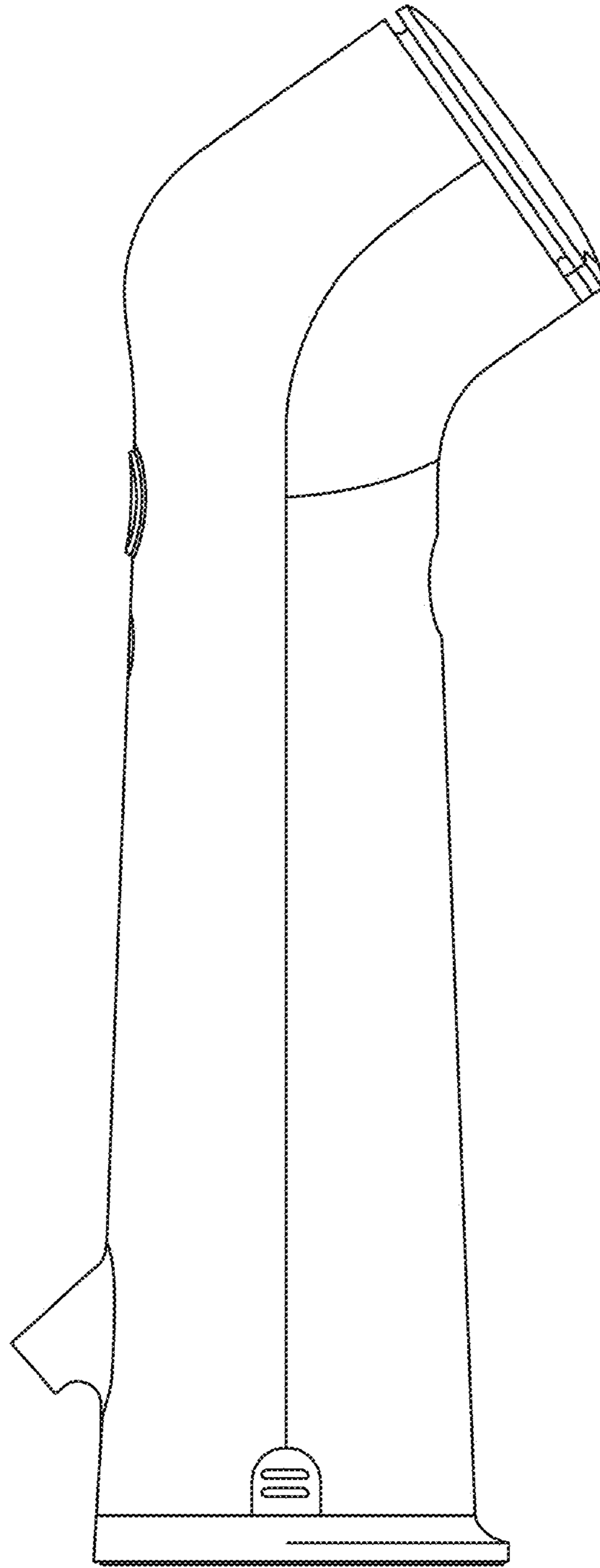

FIG. 4

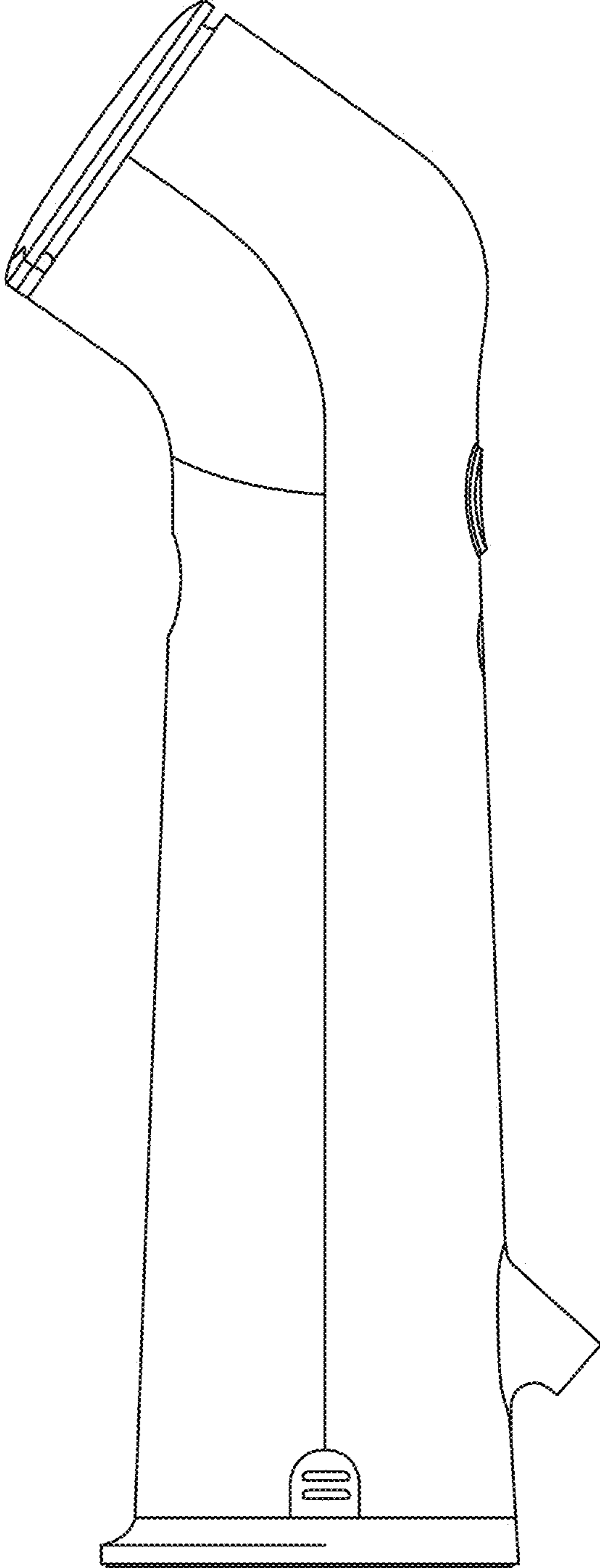

FIG. 5

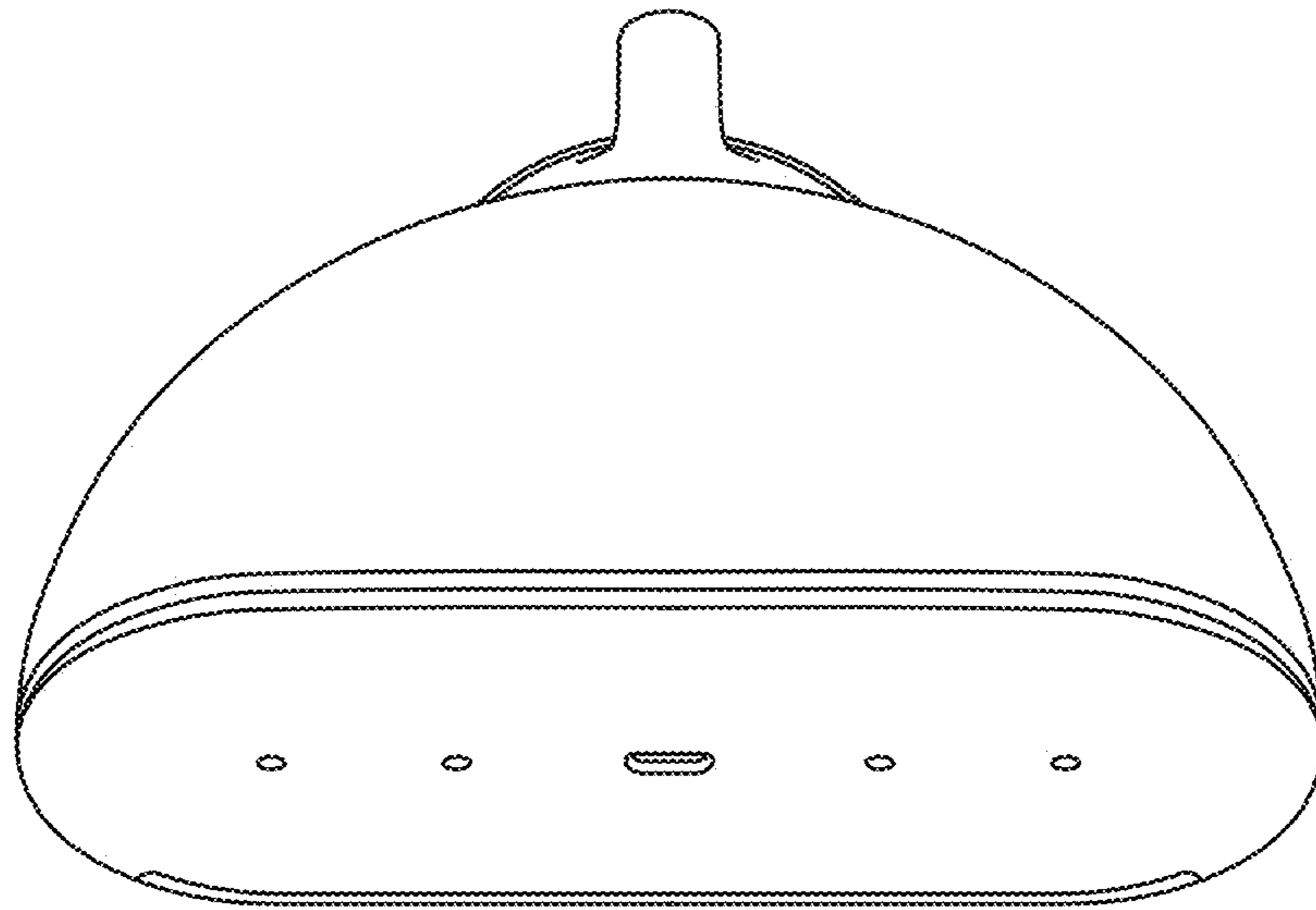

FIG. 6

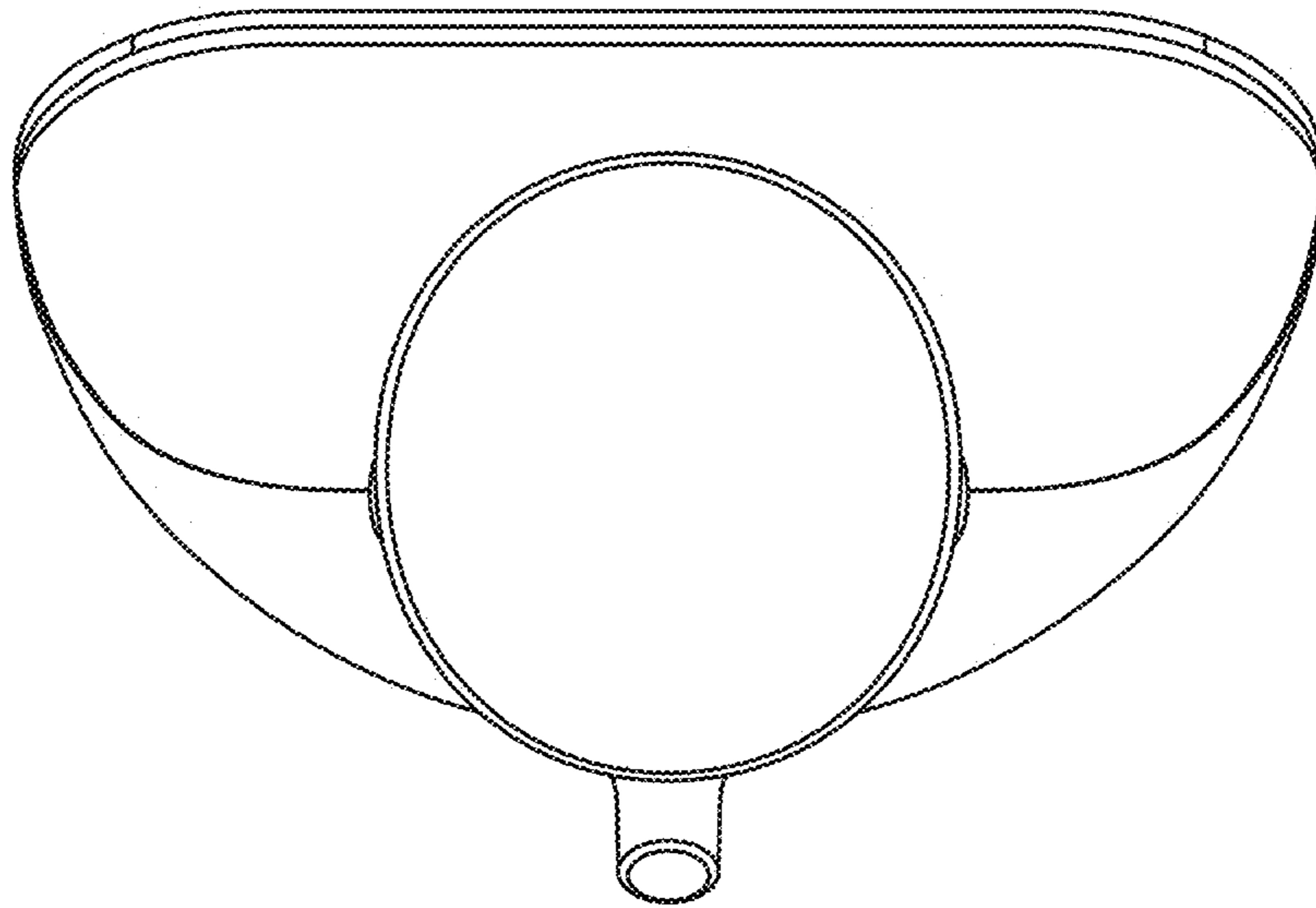

FIG. 7

UNITED STATES PATENT AND TRADEMARK OFFICE
CERTIFICATE OF CORRECTION

PATENT NO. : D955,072 S
APPLICATION NO. : 29/745507
DATED : June 14, 2022
INVENTOR(S) : Frej Lewenhaupt et al.

Page 1 of 1

It is certified that error appears in the above-identified patent and that said Letters Patent is hereby corrected as shown below:

On the Title Page

In Item (12) change "Lewenhaupt Sandberg et al." to --Lewenhaupt et al.--

In Item (72) "Inventors" change "Frej LEWENHAUPT SANDBERG" to --Frej LEWENHAUPT--

Signed and Sealed this
Fifth Day of March, 2024



Katherine Kelly Vidal
Director of the United States Patent and Trademark Office