



US00D955049S

(12) **United States Design Patent** (10) **Patent No.:** **US D955,049 S**
Tran (45) **Date of Patent:** **** *Jun. 14, 2022**

(54) **ELECTRIC RAZOR**

(71) Applicant: **Manscaped, LLC**, San Diego, CA (US)

(72) Inventor: **Anh Hao Tran**, San Diego, CA (US)

(73) Assignee: **Manscaped, LLC**, San Diego, CA (US)

(*) Notice: This patent is subject to a terminal disclaimer.

(**) Term: **15 Years**

(21) Appl. No.: **29/763,688**

(22) Filed: **Dec. 23, 2020**

Related U.S. Application Data

(63) Continuation of application No. 29/694,217, filed on Jun. 7, 2019, now Pat. No. Des. 908,962.

(51) **LOC (13) Cl.** **28-03**

(52) **U.S. Cl.**
USPC **D28/53; D28/51**

(58) **Field of Classification Search**
USPC D28/49, 51, 53, 54
(Continued)

(56) **References Cited**

U.S. PATENT DOCUMENTS

D608,051 S * 1/2010 Tamsiran D28/44.1
D646,437 S * 10/2011 Leventhal D28/49
(Continued)

Primary Examiner — Jennifer Rivard

(74) *Attorney, Agent, or Firm* — Adsero IP

(57) **CLAIM**

An ornamental design for an electric razor, as shown and described.

DESCRIPTION

FIG. 1 is a perspective view of an electric razor in accordance with the present invention;

FIG. 2 is a right side view thereof;
FIG. 3 is a left side view thereof;
FIG. 4 is a front elevational view thereof;
FIG. 5 is a rear elevational view thereof;
FIG. 6 is a top view thereof;
FIG. 7 is a bottom view thereof;
FIG. 8 is a front perspective view of another embodiment of an electric razor in accordance with the present invention;
FIG. 9 is a right side view thereof;
FIG. 10 is a left side view thereof;
FIG. 11 is a front elevational view thereof;
FIG. 12 is a rear elevational view thereof;
FIG. 13 is a top view thereof;
FIG. 14 is a bottom view thereof;
FIG. 15 is a front perspective view of another embodiment of an electric razor in accordance with the present invention;
FIG. 16 is a right side view thereof;
FIG. 17 is a left side view thereof;
FIG. 18 is a front elevational view thereof;
FIG. 19 is a rear elevational view thereof;
FIG. 20 is a top view thereof;
FIG. 21 is a bottom view thereof;
FIG. 22 is a front perspective view of another embodiment of an electric razor in accordance with the present invention;
FIG. 23 is a right side view thereof;
FIG. 24 is a left side view thereof;
FIG. 25 is a front elevational view thereof;
FIG. 26 is a rear elevational view thereof;
FIG. 27 is a top view thereof;
FIG. 28 is a bottom view thereof;
FIG. 29 is a front perspective view of another embodiment of an electric razor in accordance with the present invention;
FIG. 30 is a right side view thereof;
FIG. 31 is a left side view thereof;
FIG. 32 is a front elevational view thereof;
FIG. 33 is a rear elevational view thereof;
FIG. 34 is a top view thereof; and
FIG. 35 is a bottom view thereof.
The broken lines illustrate portions of the electric razor and form no part of the claimed design.

1 Claim, 20 Drawing Sheets

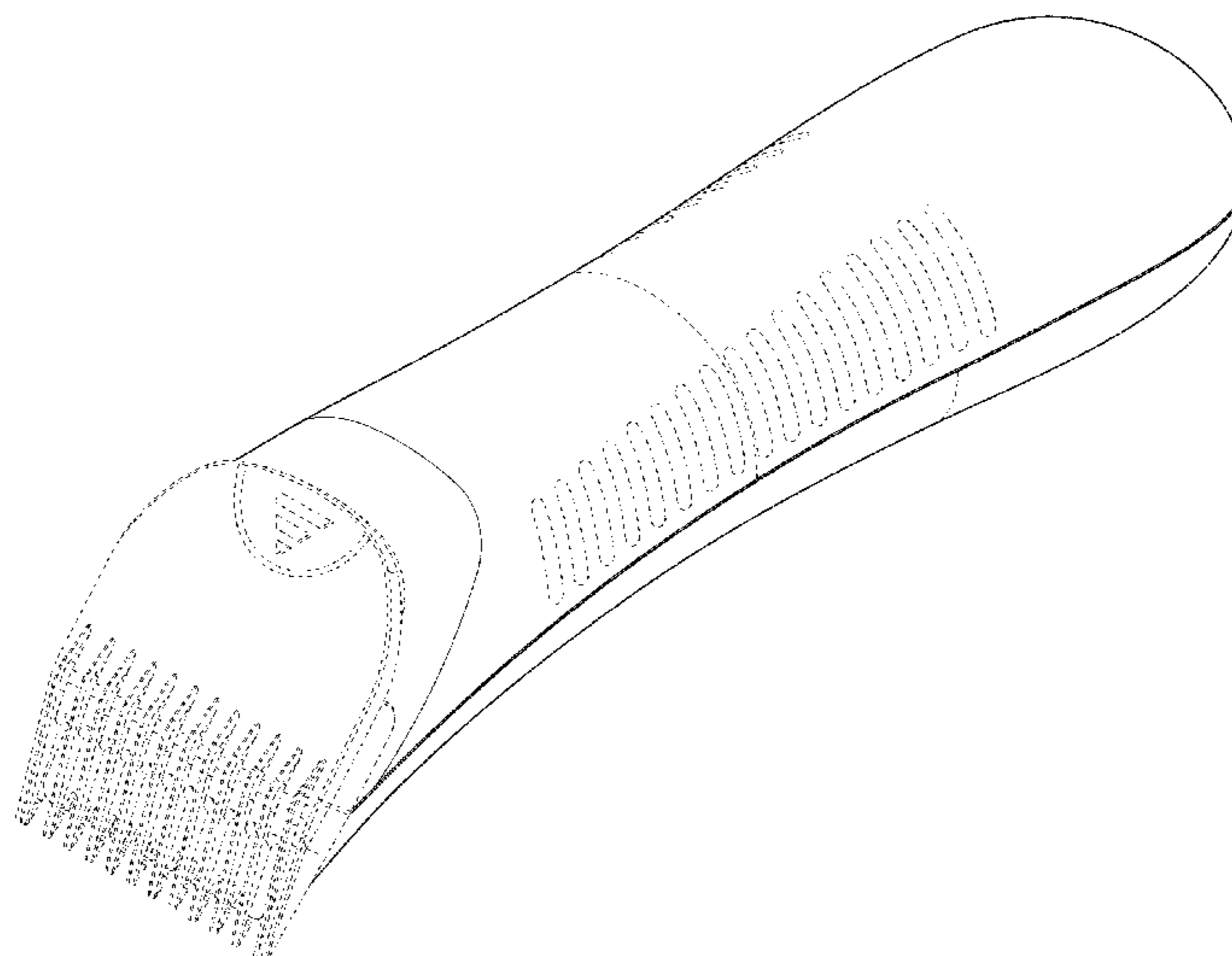

(58) **Field of Classification Search**

CPC .. B26B 19/3853–3866; B26B 19/3886; B26B
19/20; B26B 19/205; B26B 19/22; B26B
19/00–107

See application file for complete search history.

(56) **References Cited**

U.S. PATENT DOCUMENTS

D698,083	S	*	1/2014	Werner	D28/53
D723,217	S	*	2/2015	Wong	D28/51
D800,965	S	*	10/2017	Aulwes	D28/53
D808,592	S	*	1/2018	Fleming	D28/53
D854,747	S	*	7/2019	Kimchi	D28/53
D864,483	S	*	10/2019	Chen	D28/53
D908,962	S	*	1/2021	Tran	D28/51
D943,209	S	*	2/2022	Miller	D28/53
D946,827	S	*	3/2022	Hunt	D28/53
D946,828	S	*	3/2022	Liang	D28/73
D947,453	S	*	3/2022	Cai	D28/53

* cited by examiner

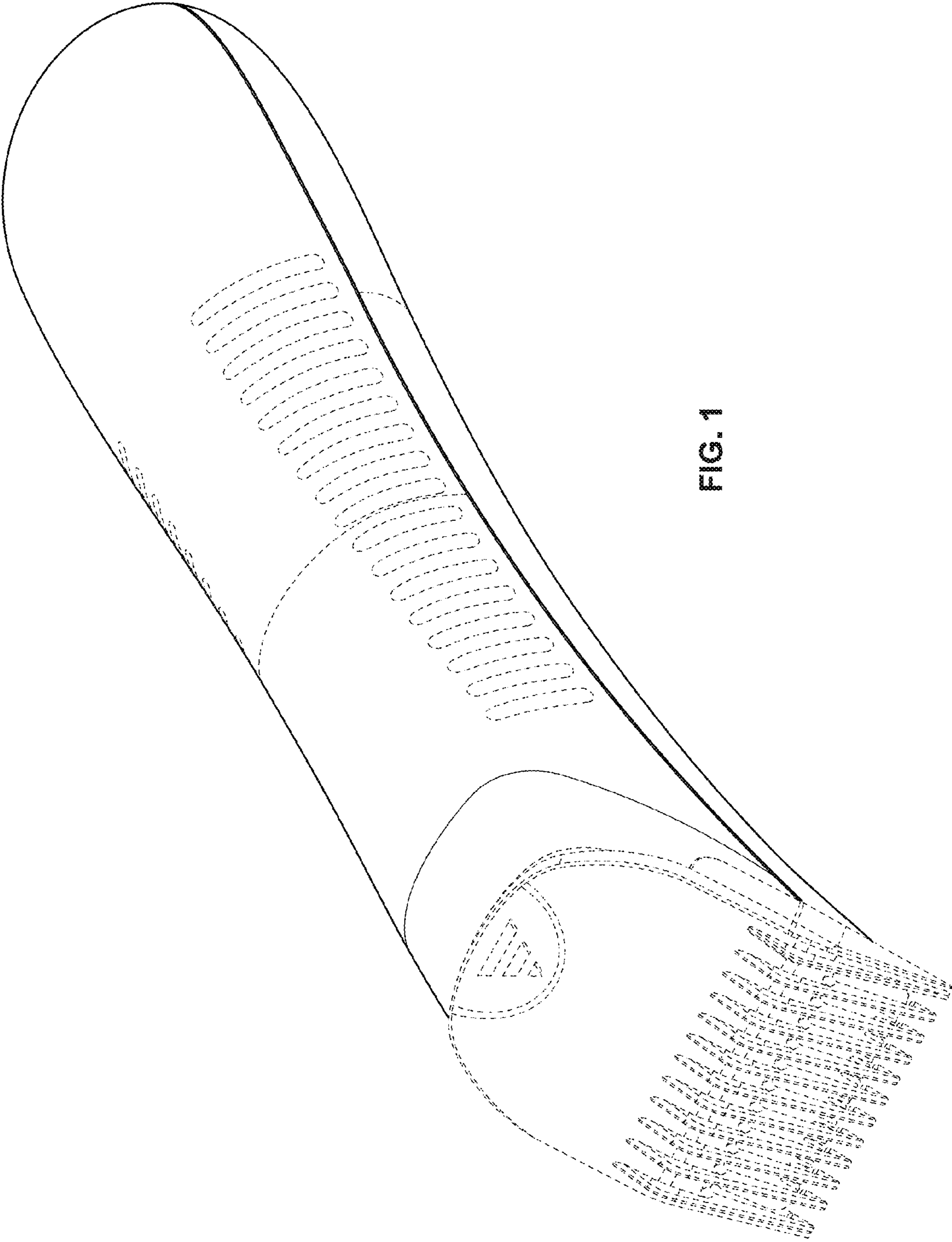

FIG. 1

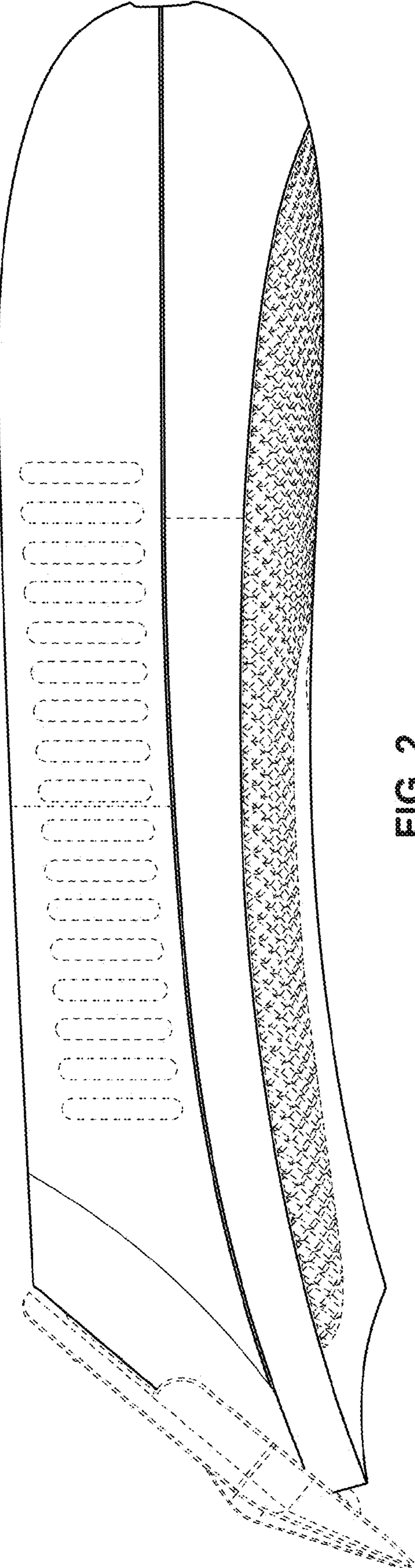

FIG. 2

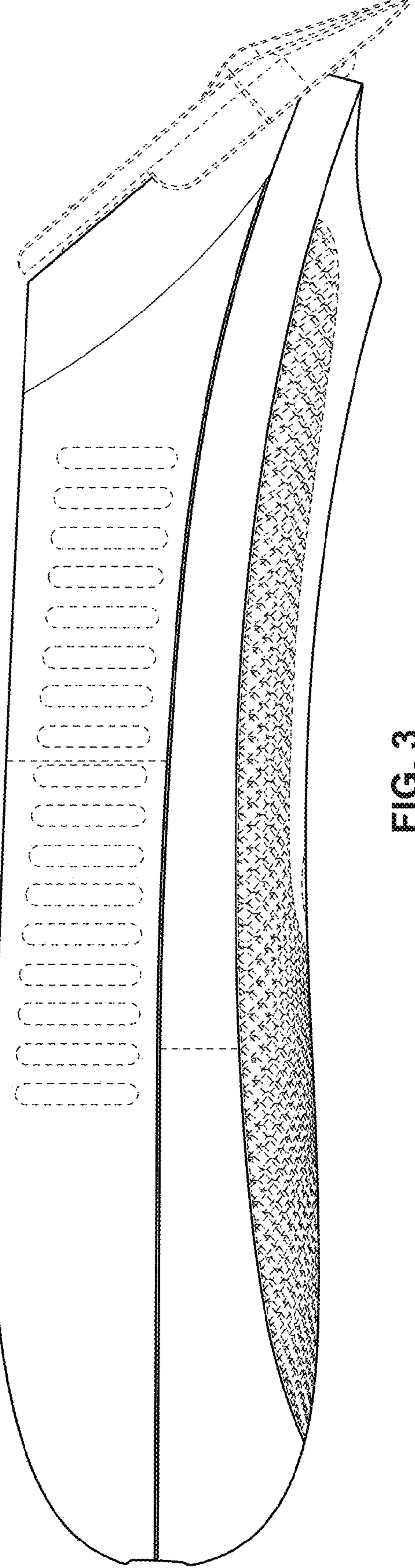

FIG. 3

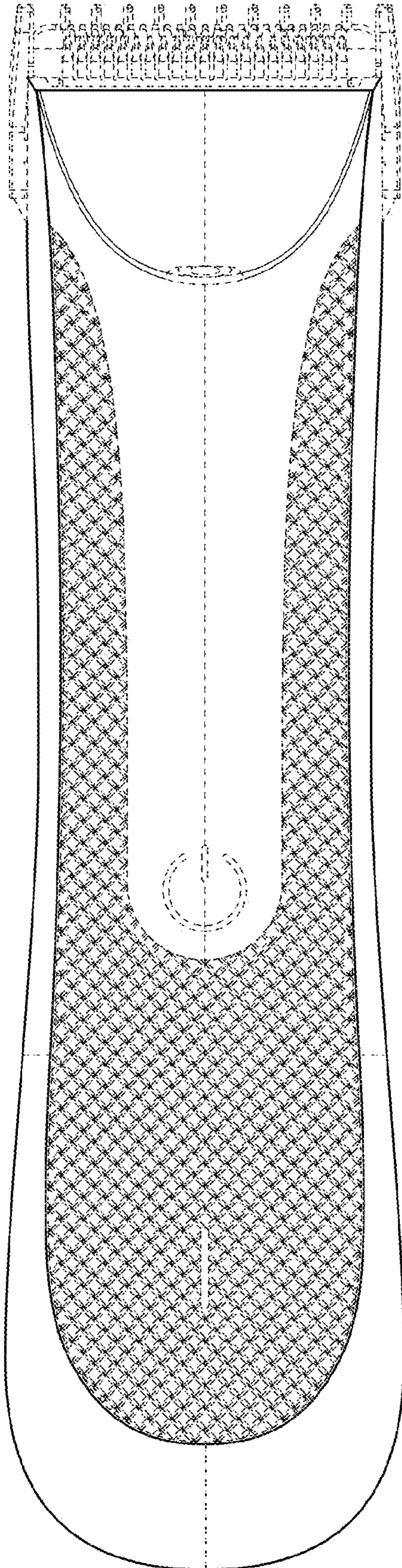

FIG. 4

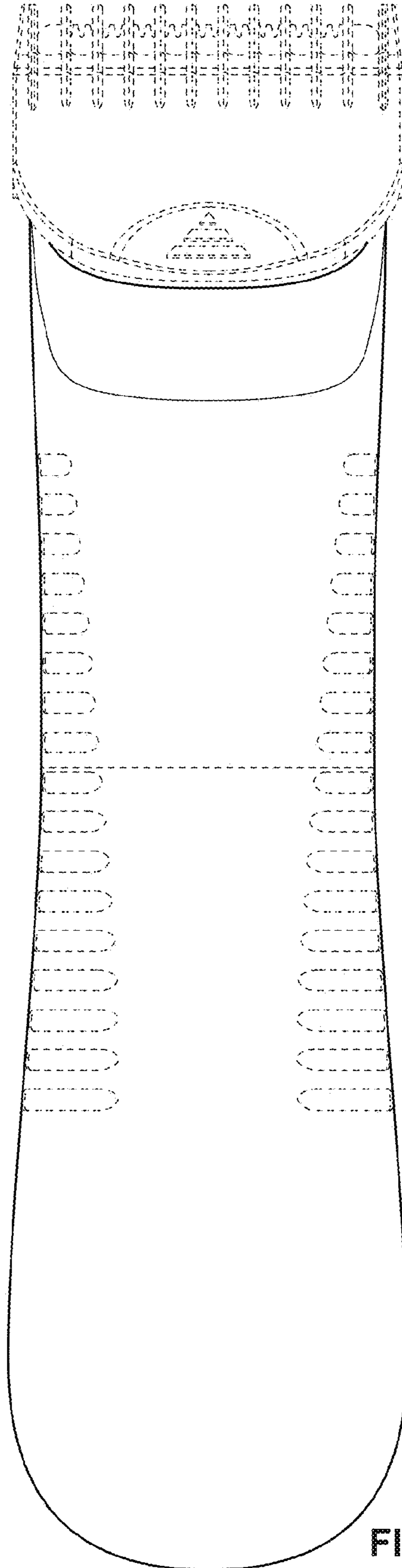

FIG. 5

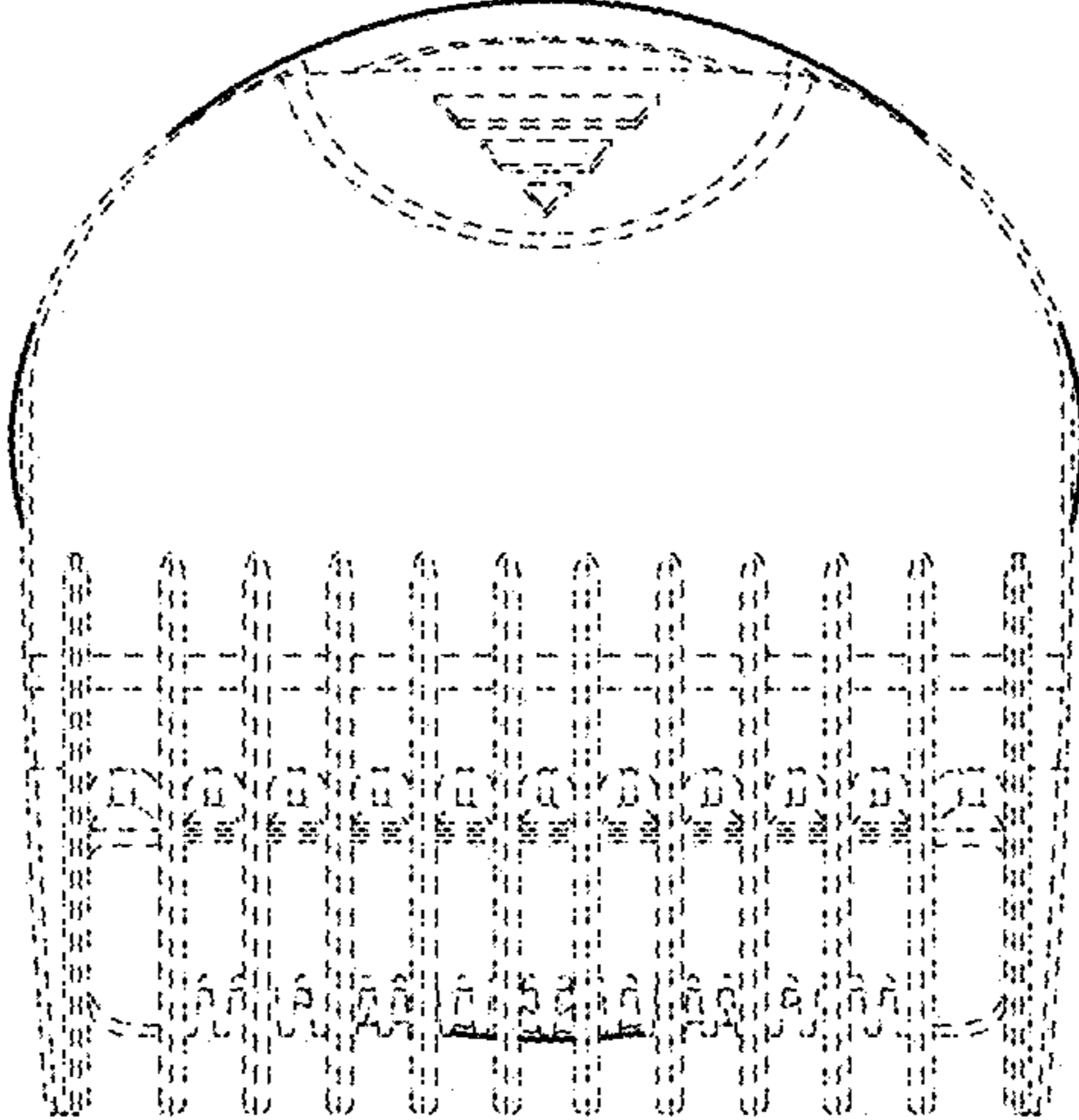

FIG. 6

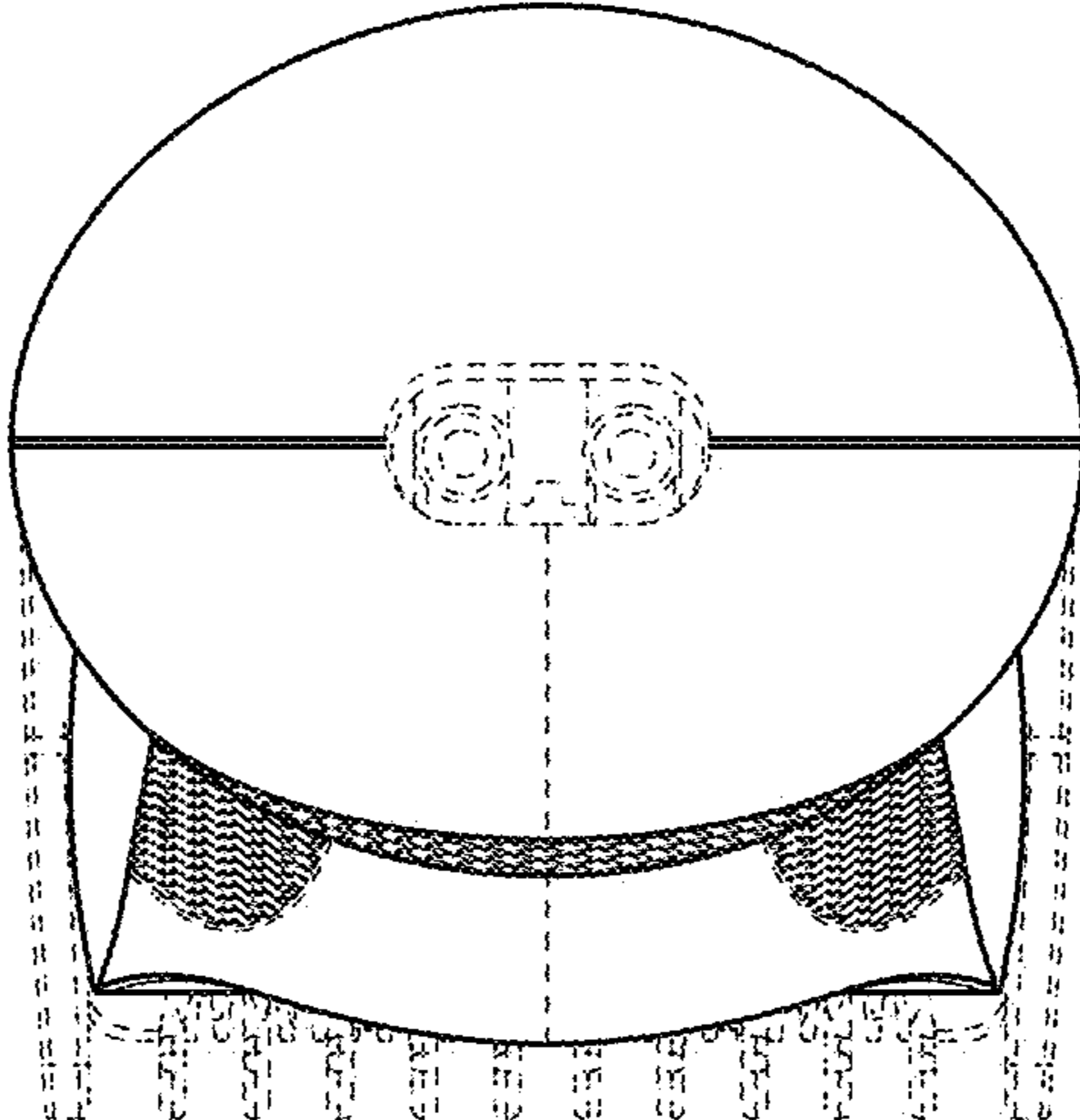

FIG. 7

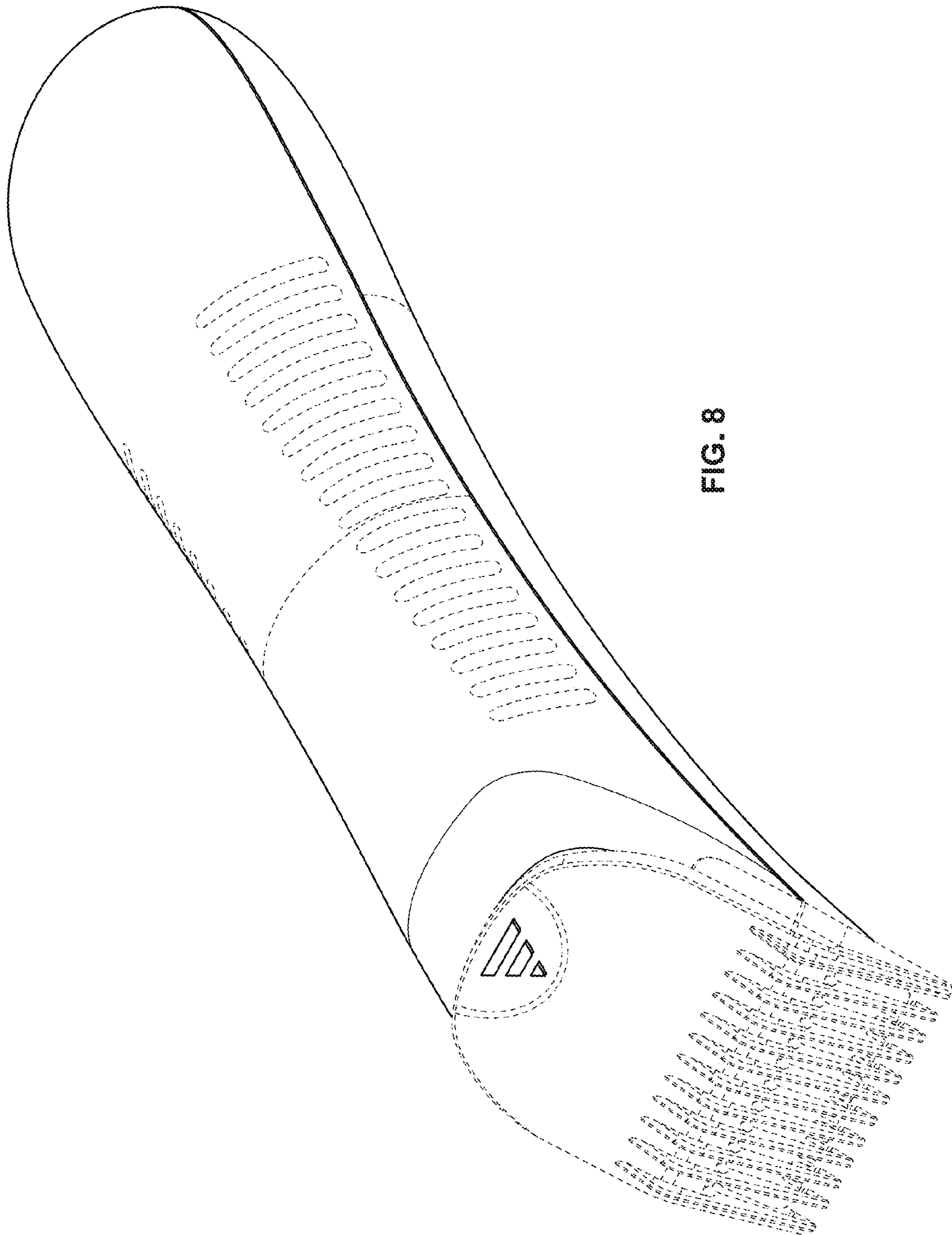

FIG. 8

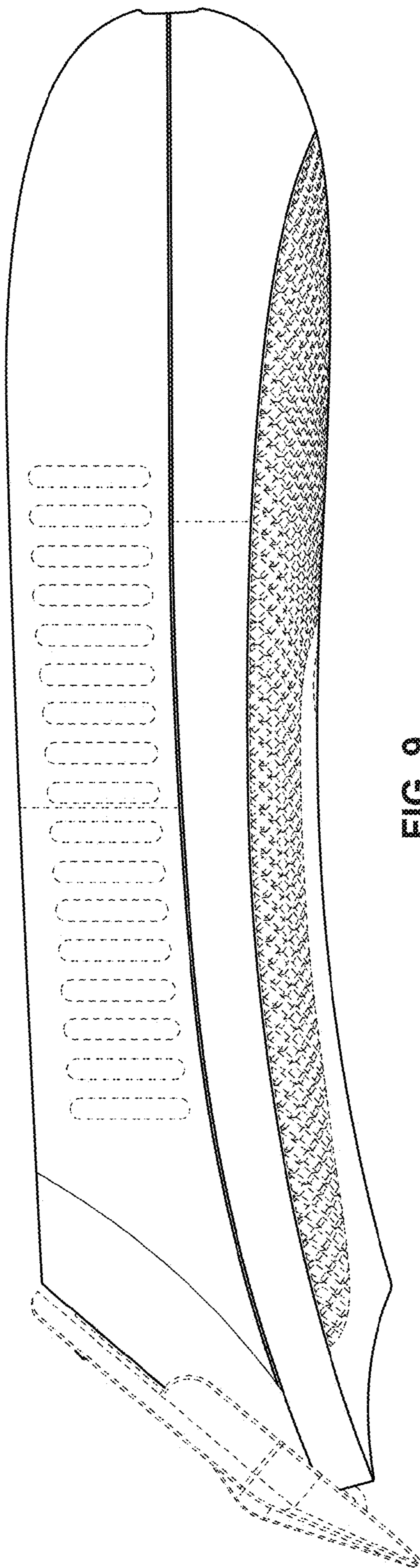

FIG. 9

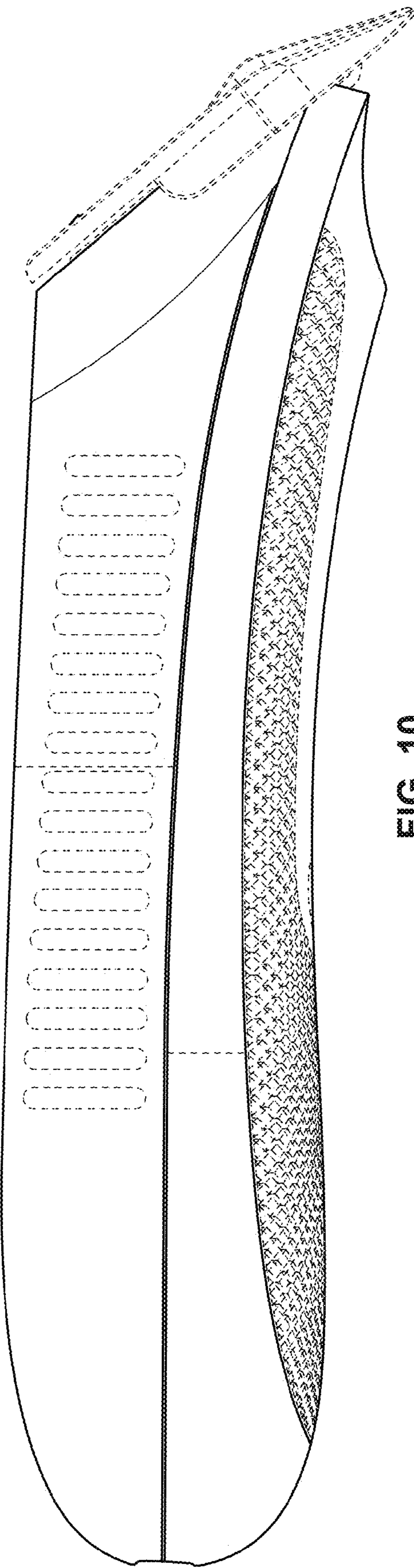

FIG. 10

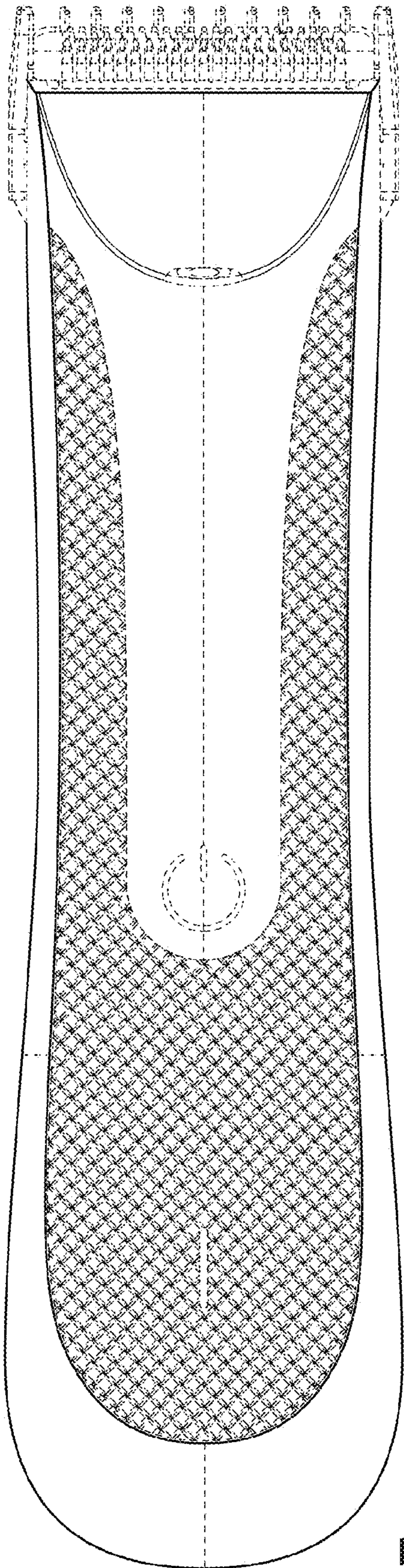

FIG. 11

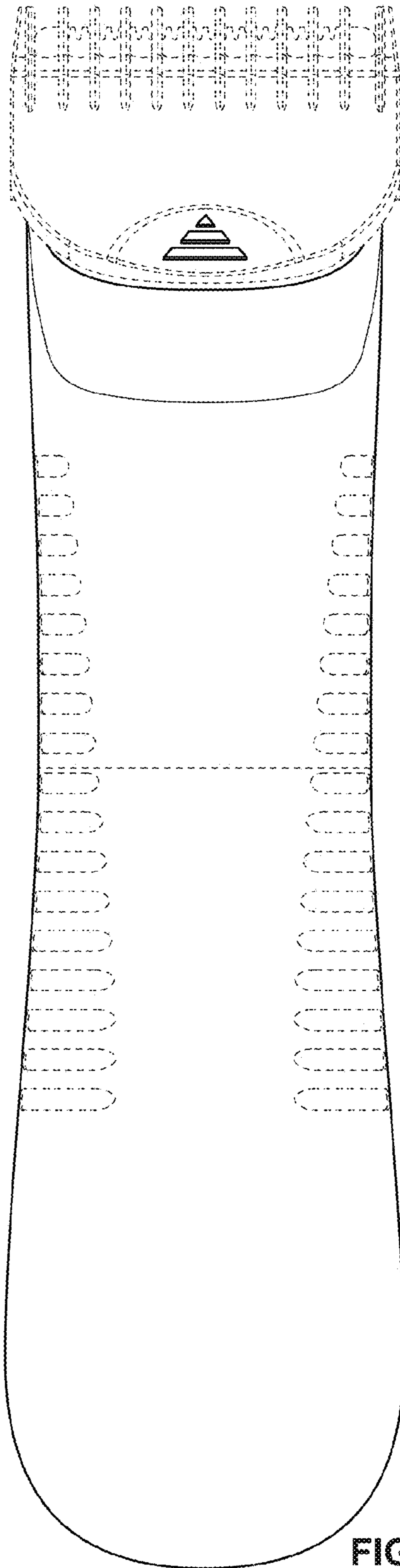

FIG. 12

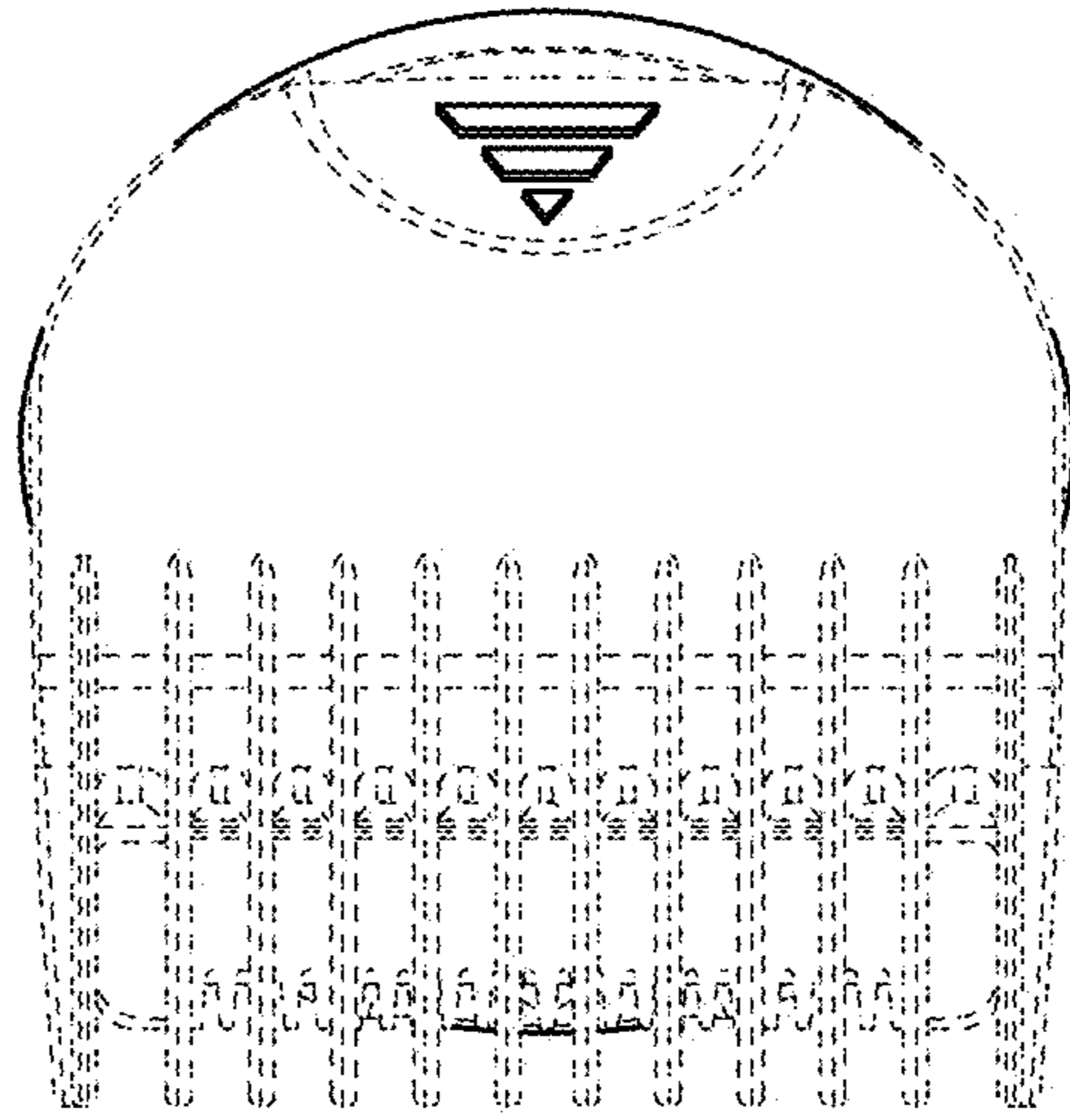

FIG. 13

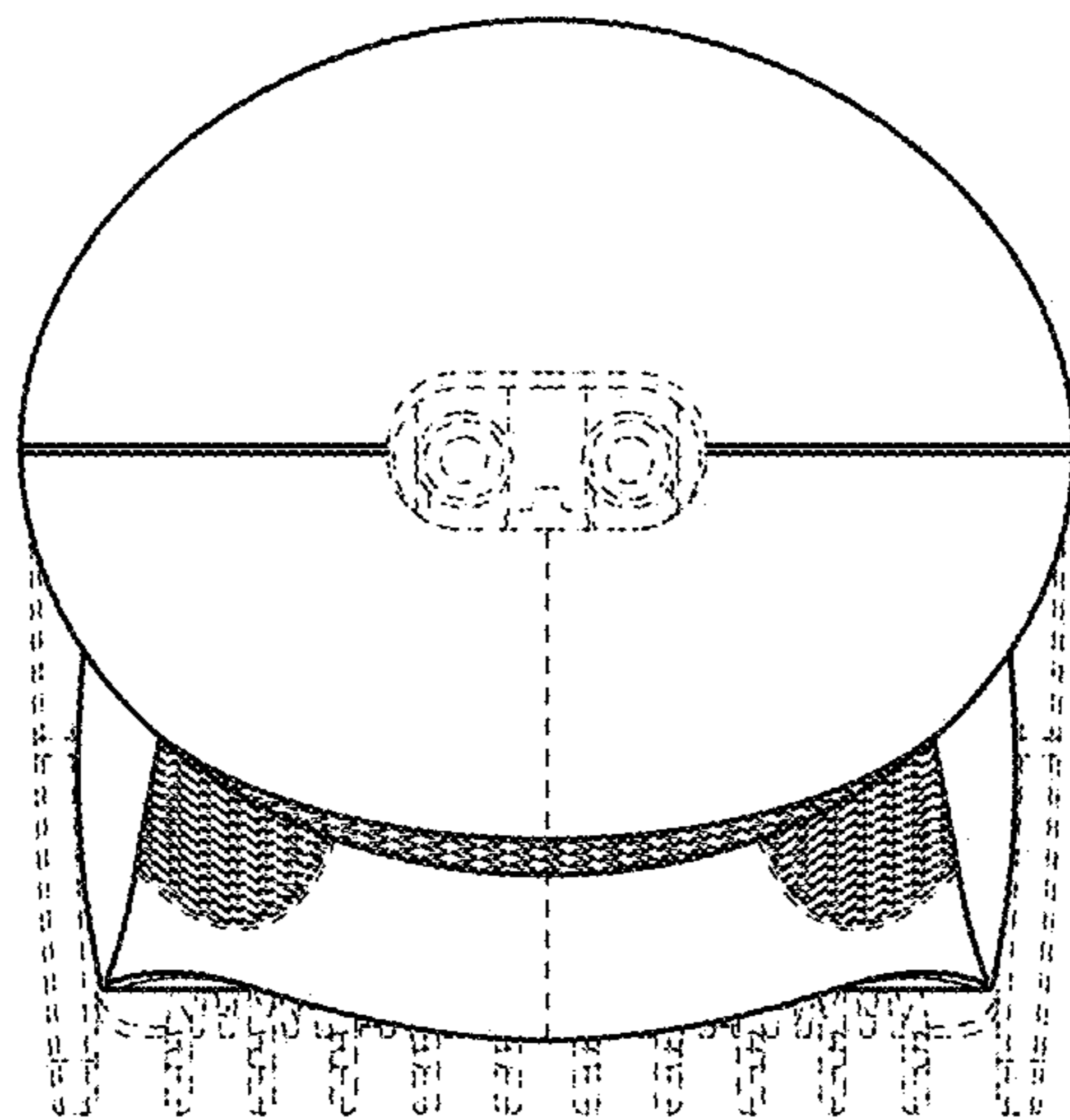

FIG. 14

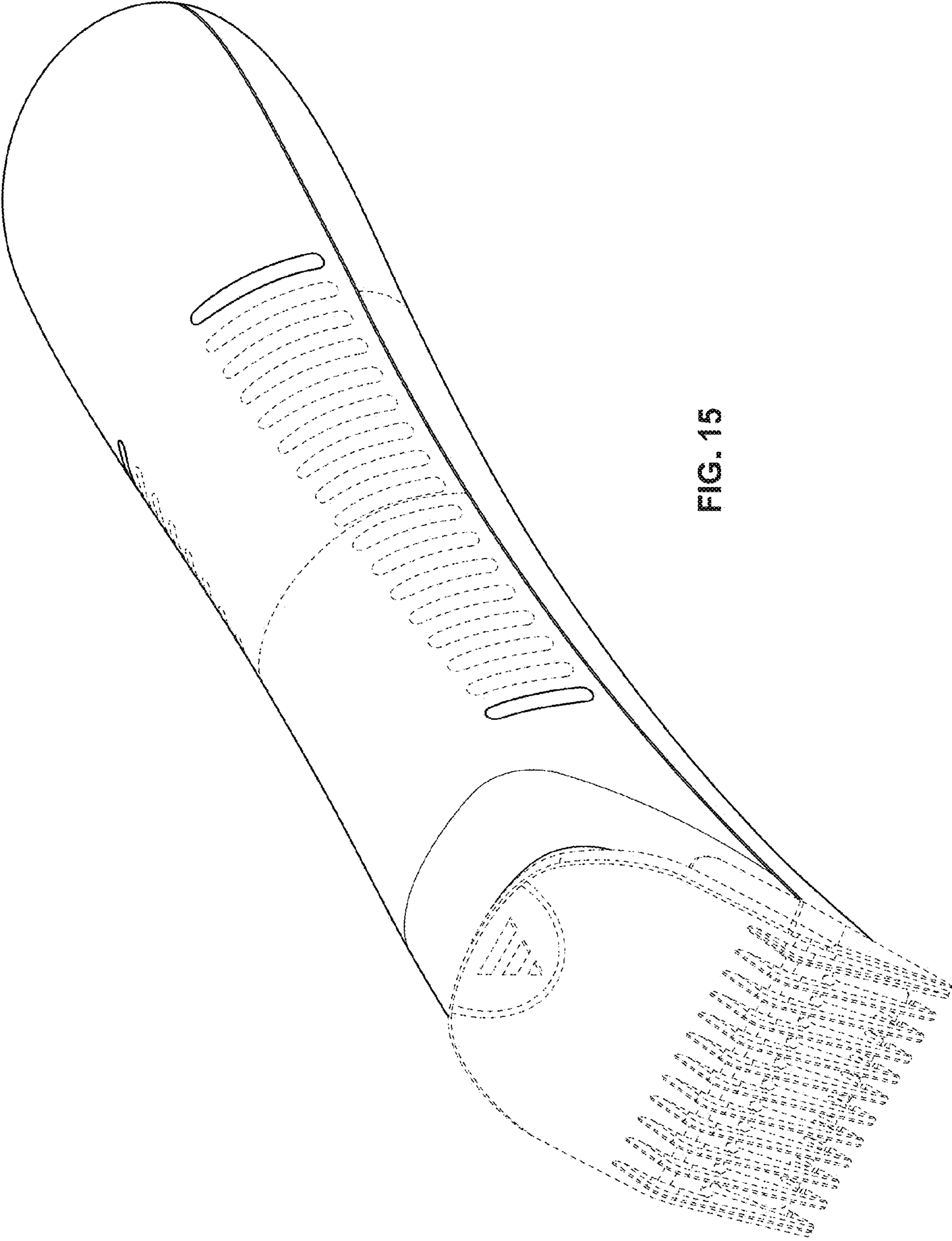

FIG. 15

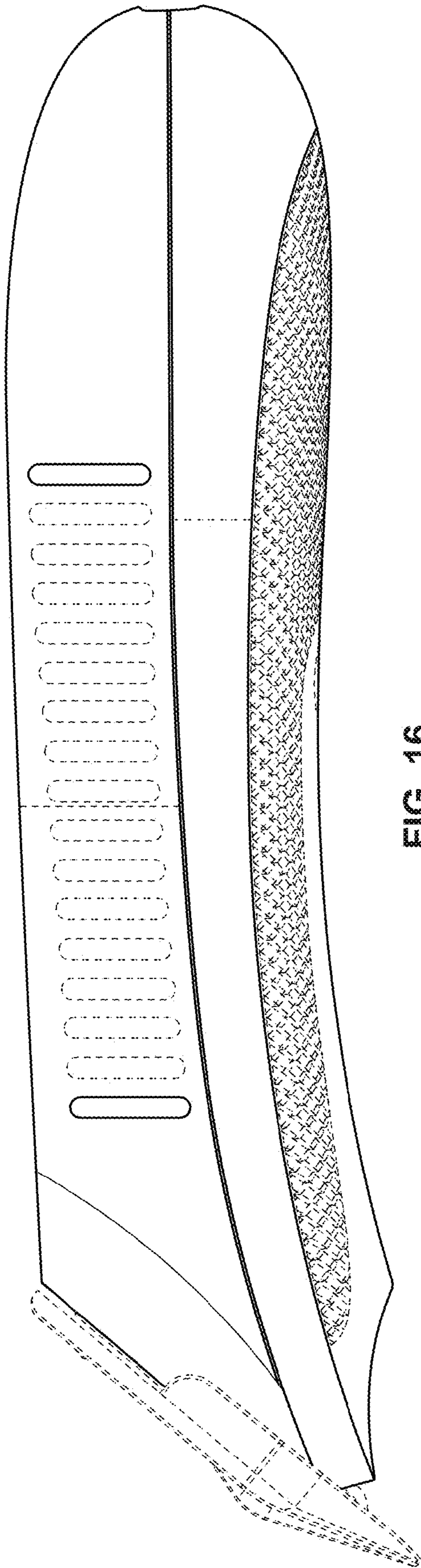

FIG. 16

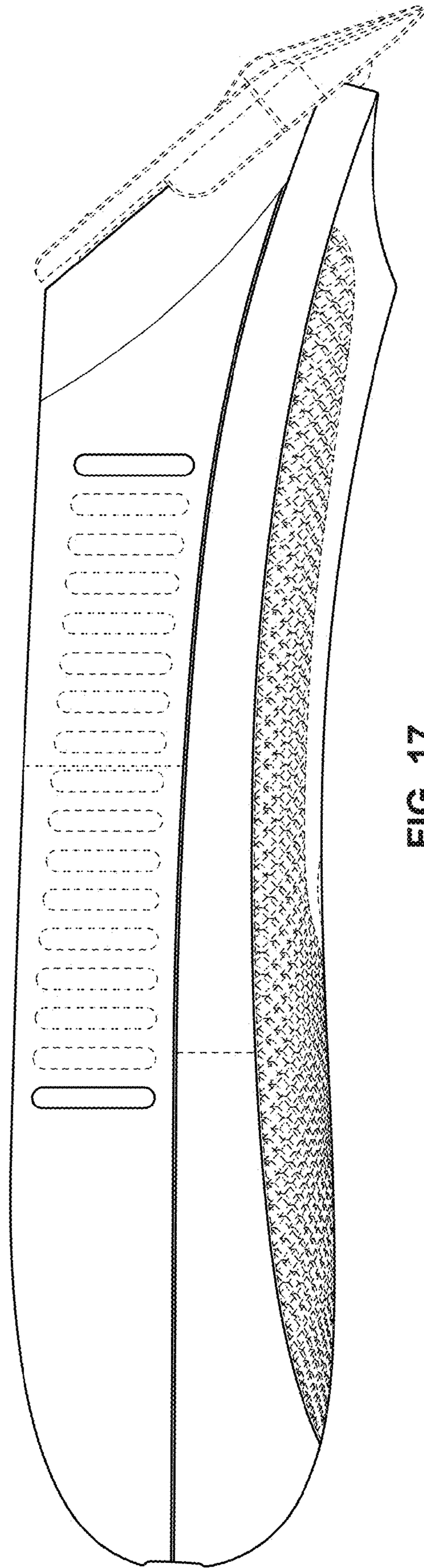

FIG. 17

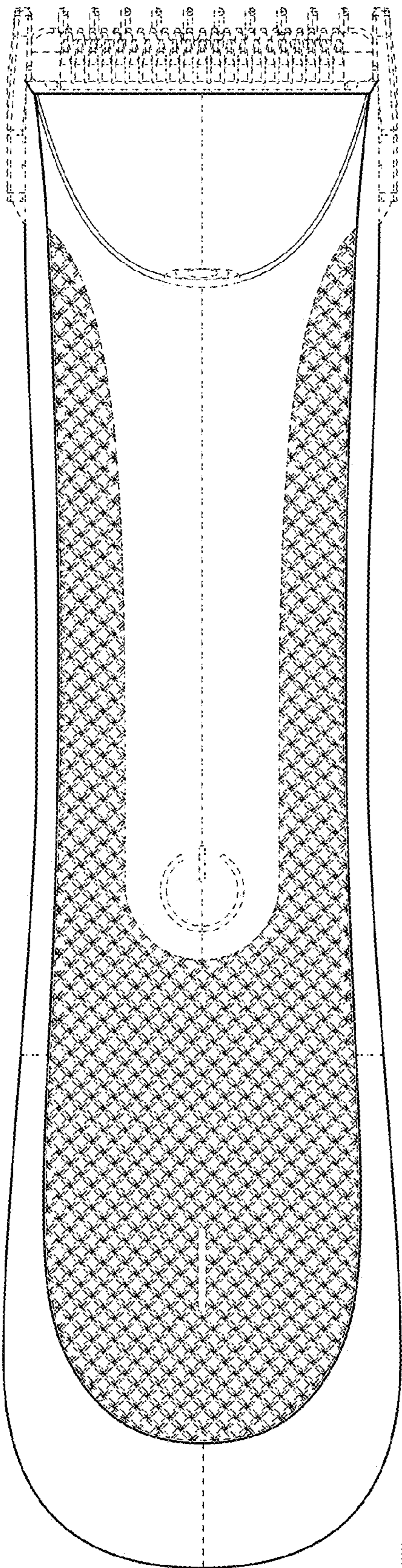

FIG. 18

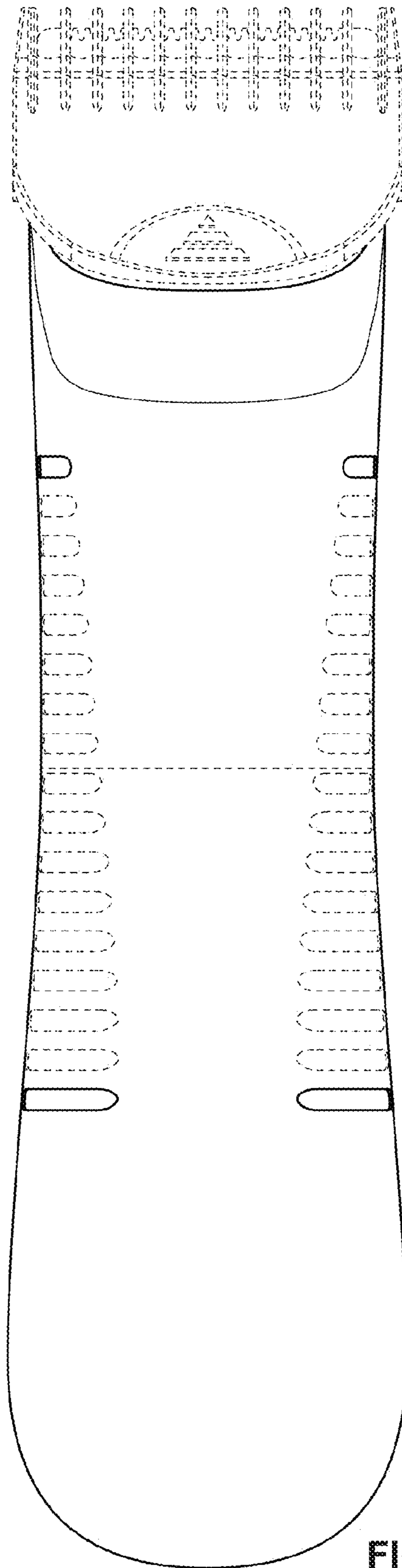

FIG. 19

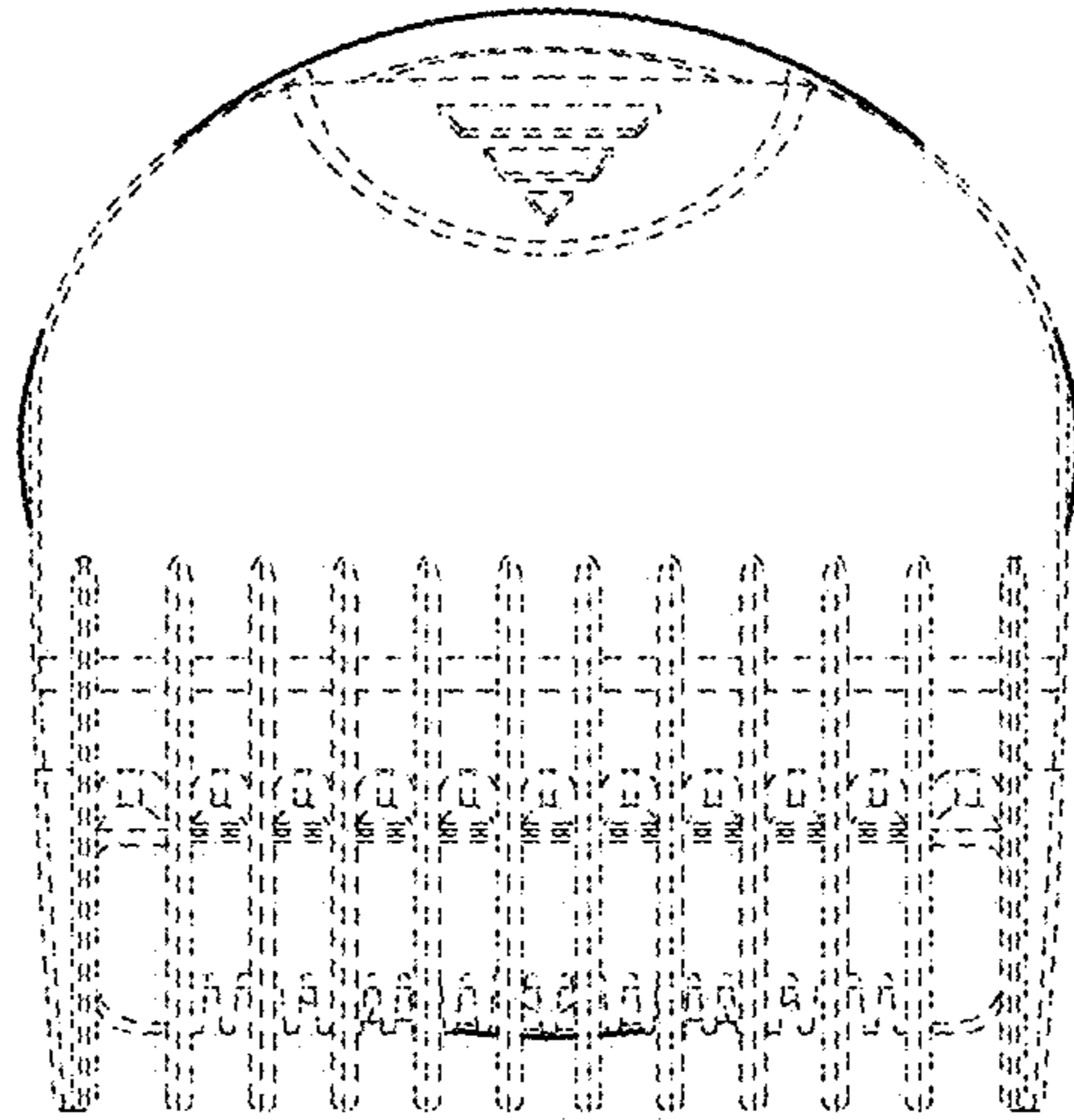

FIG. 20

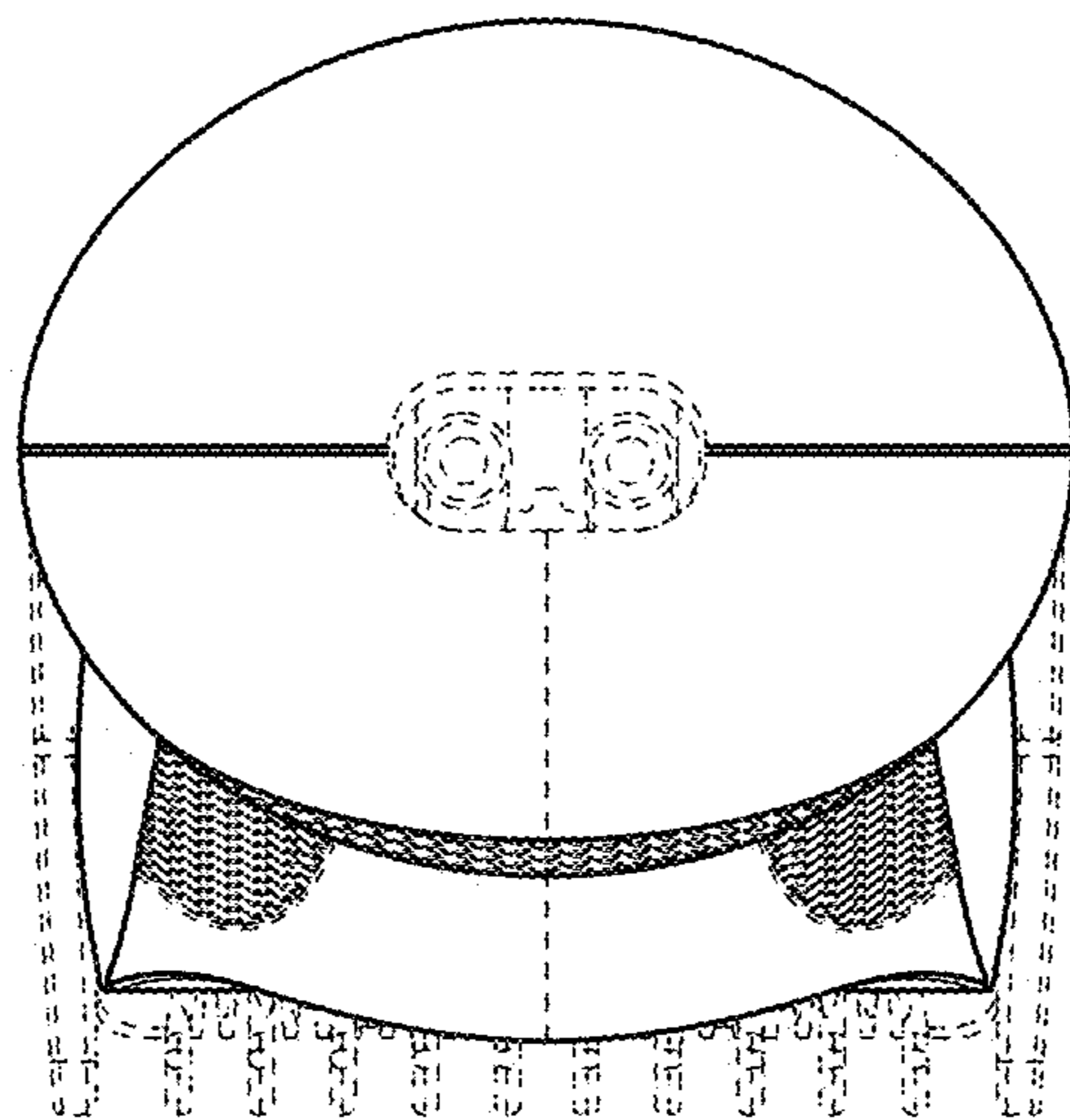

FIG. 21

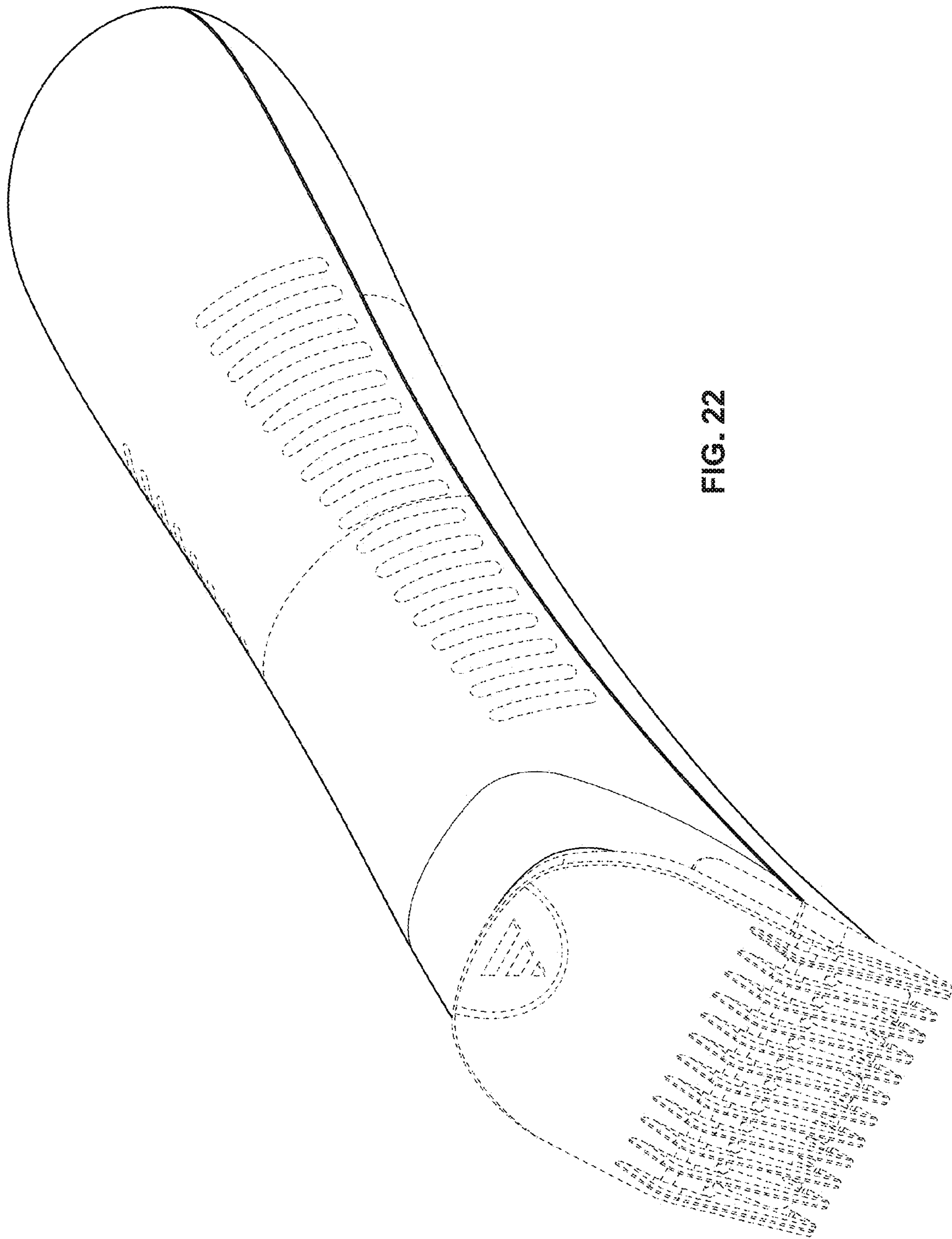

FIG. 22

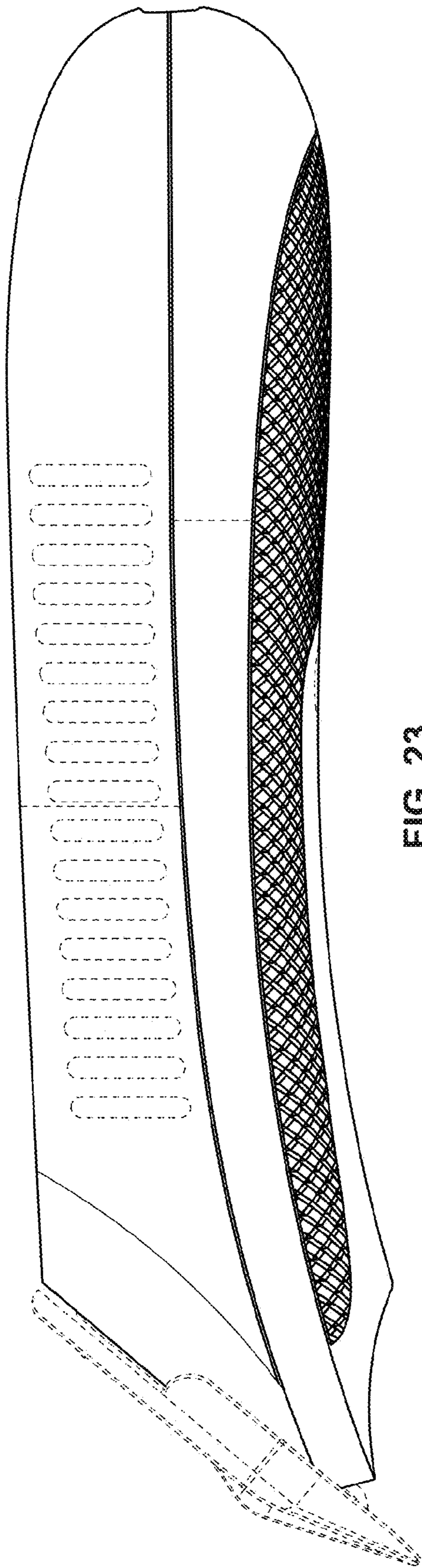

FIG. 23

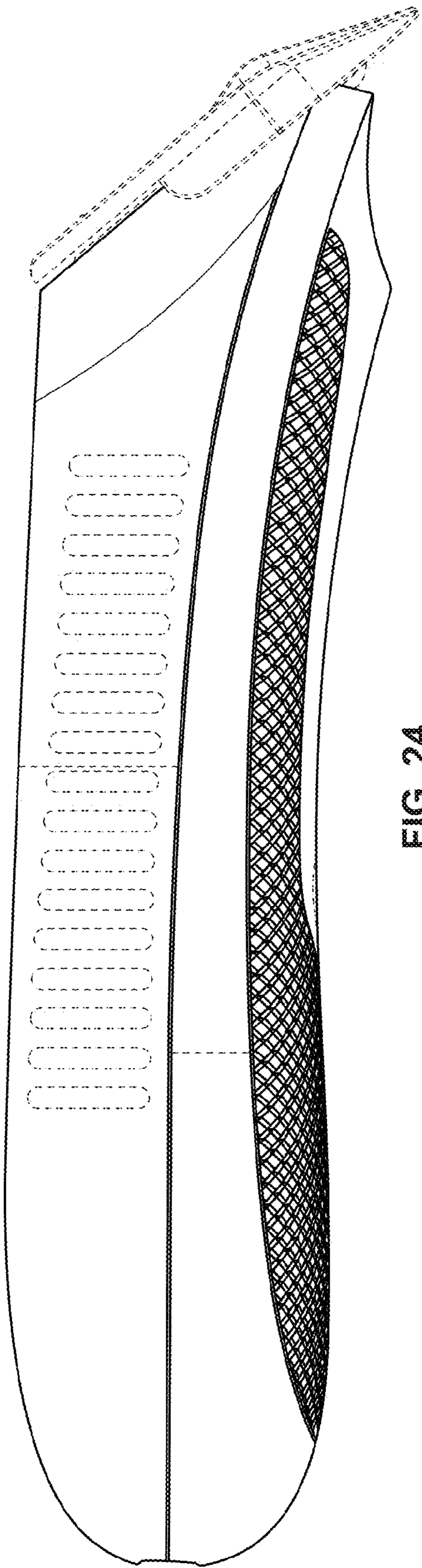

FIG. 24

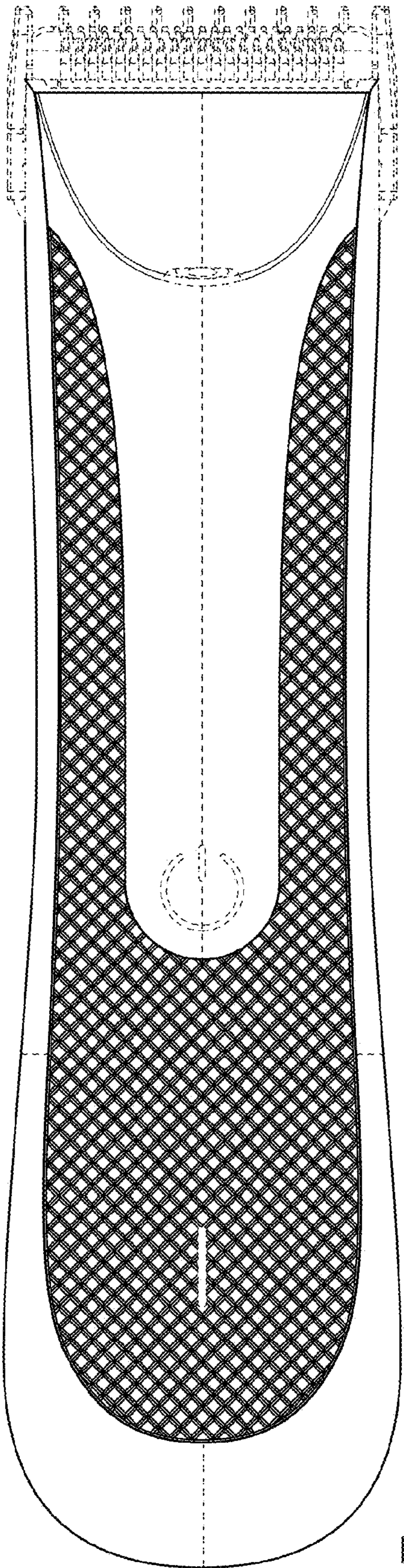

FIG. 25

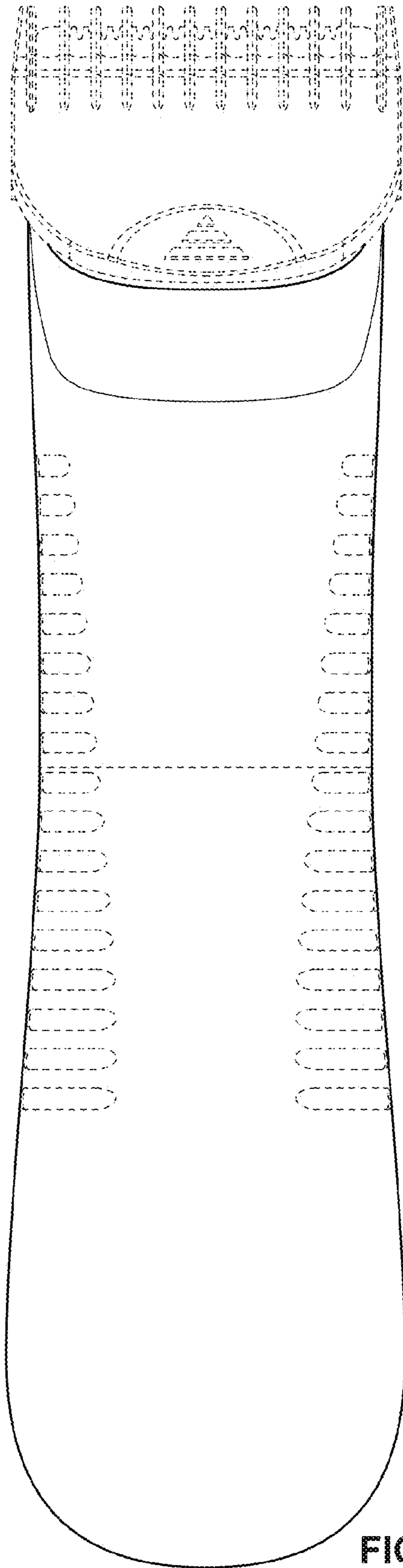

FIG. 26

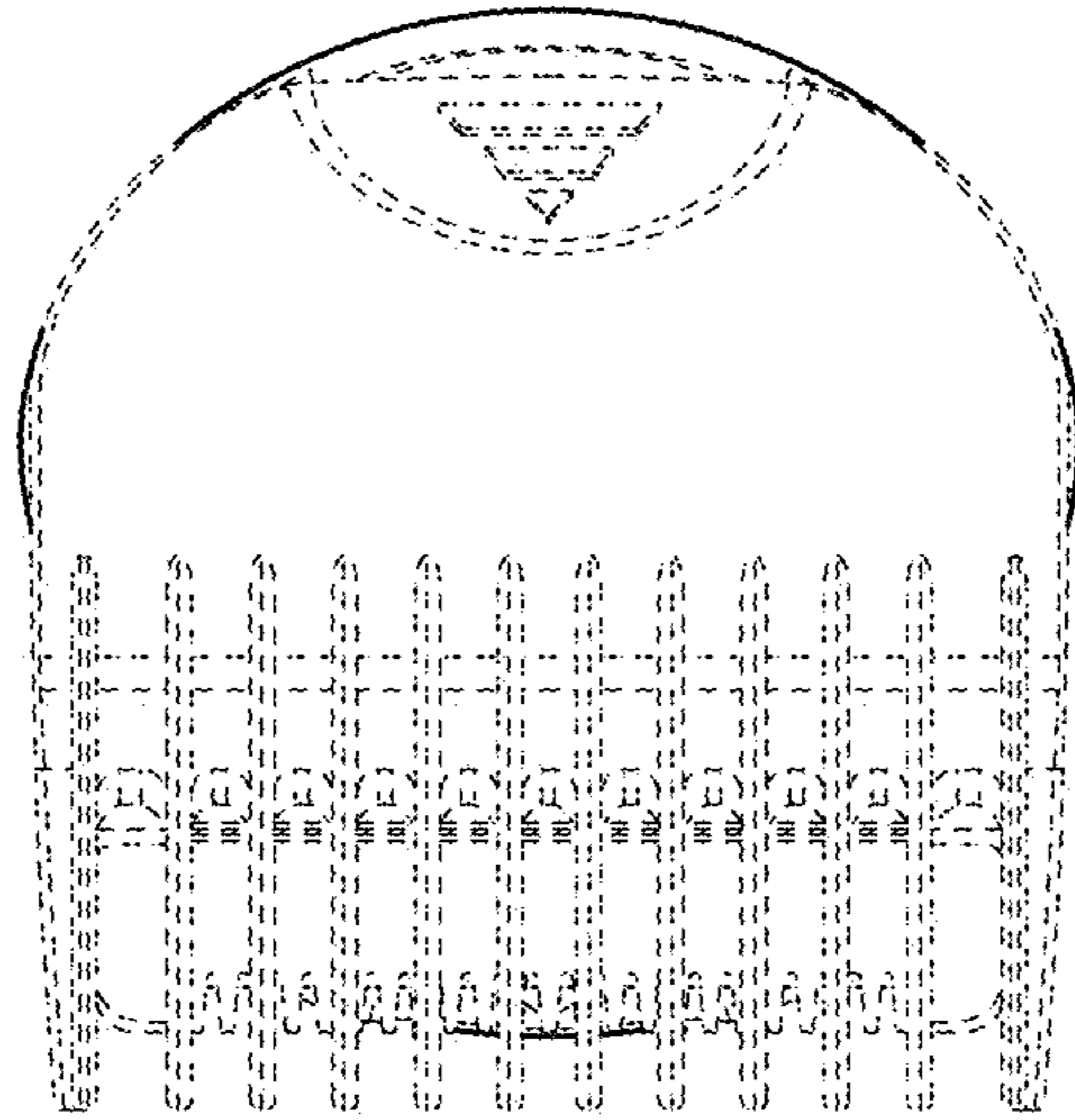

FIG. 27

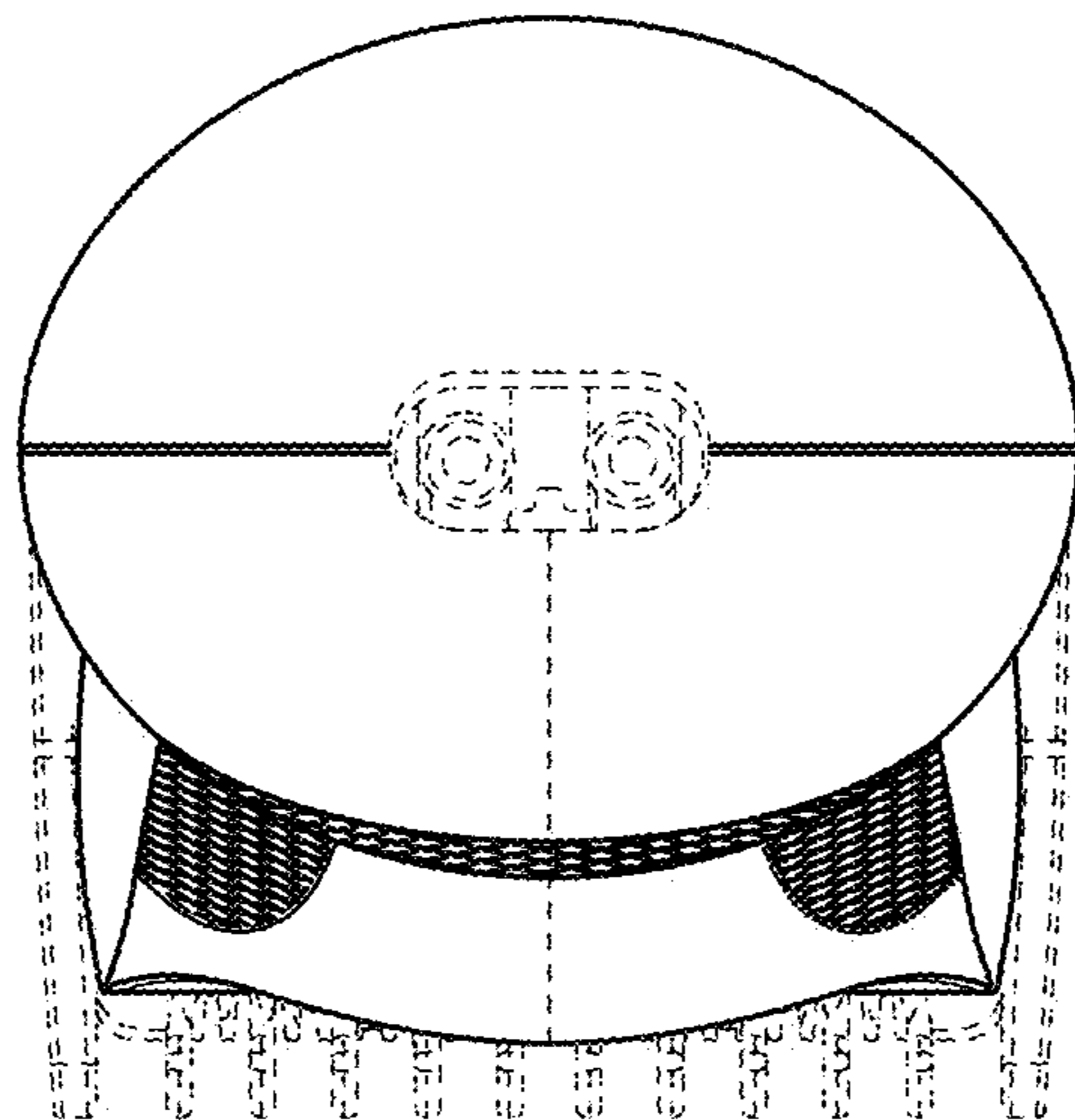

FIG. 28

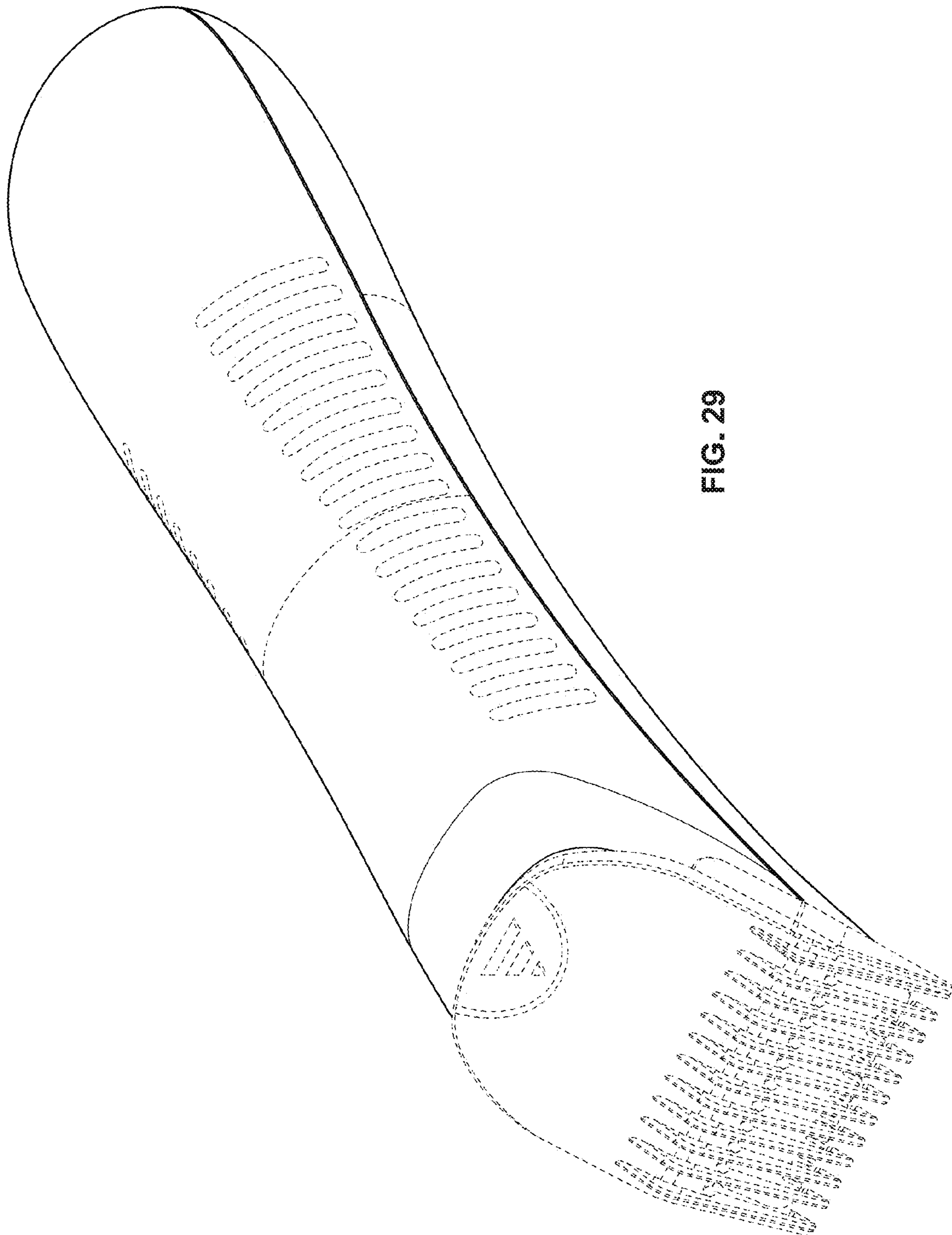

FIG. 29

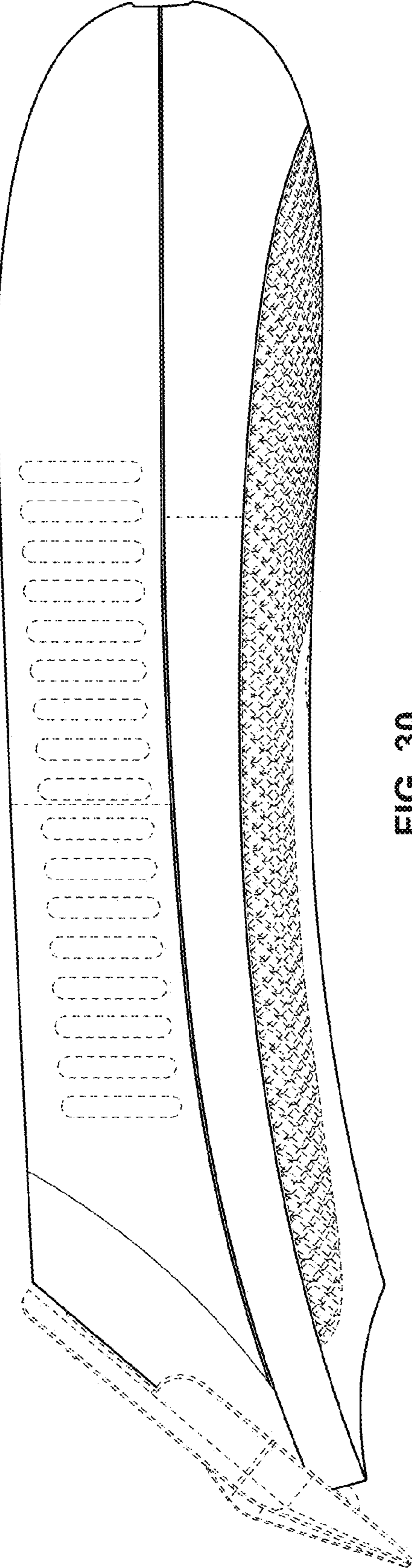

FIG. 30

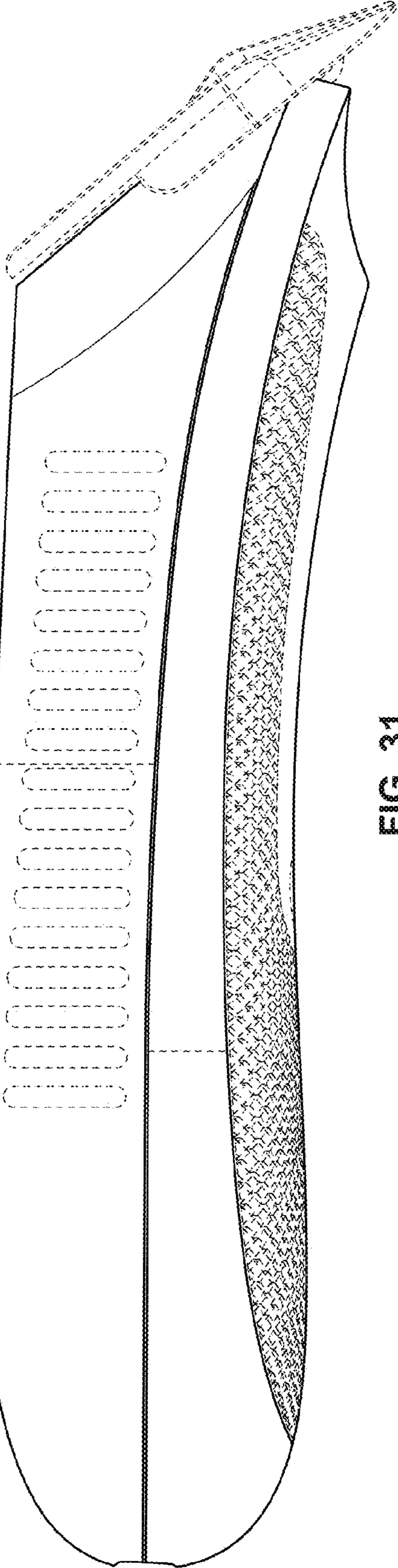

FIG. 31

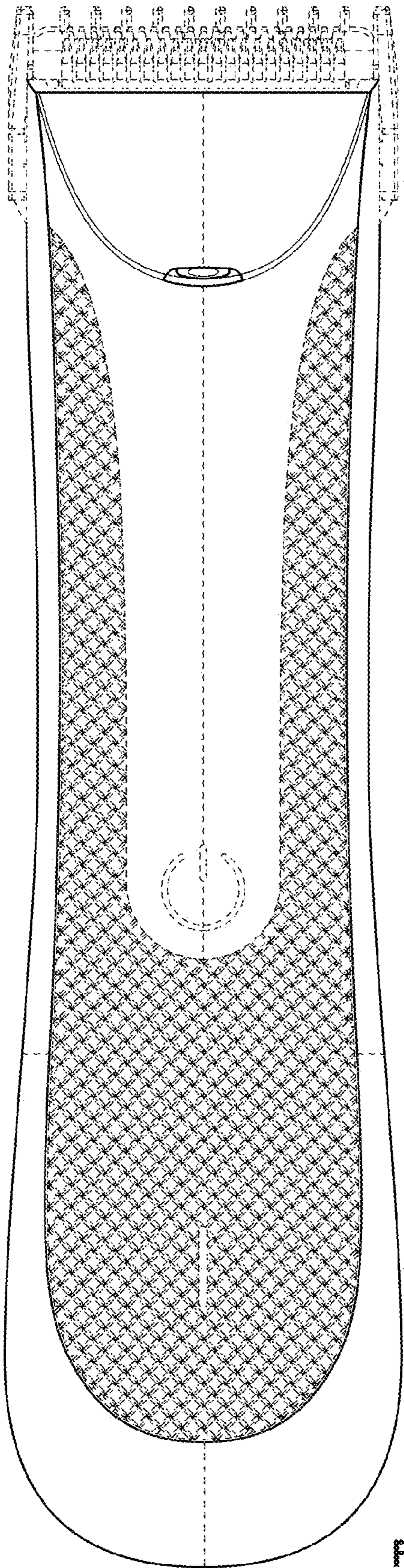

FIG. 32

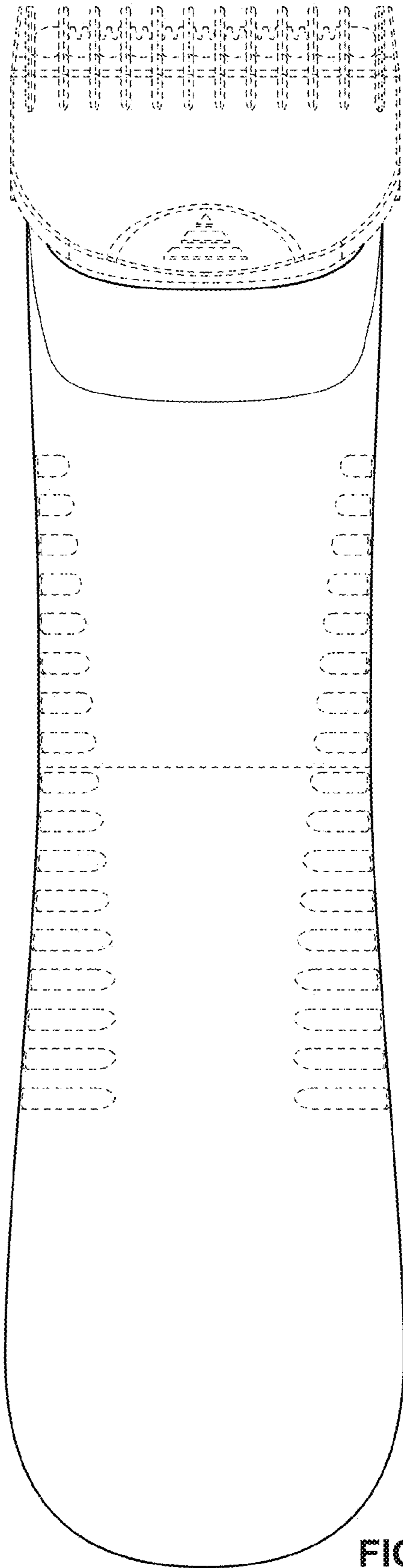

FIG. 33

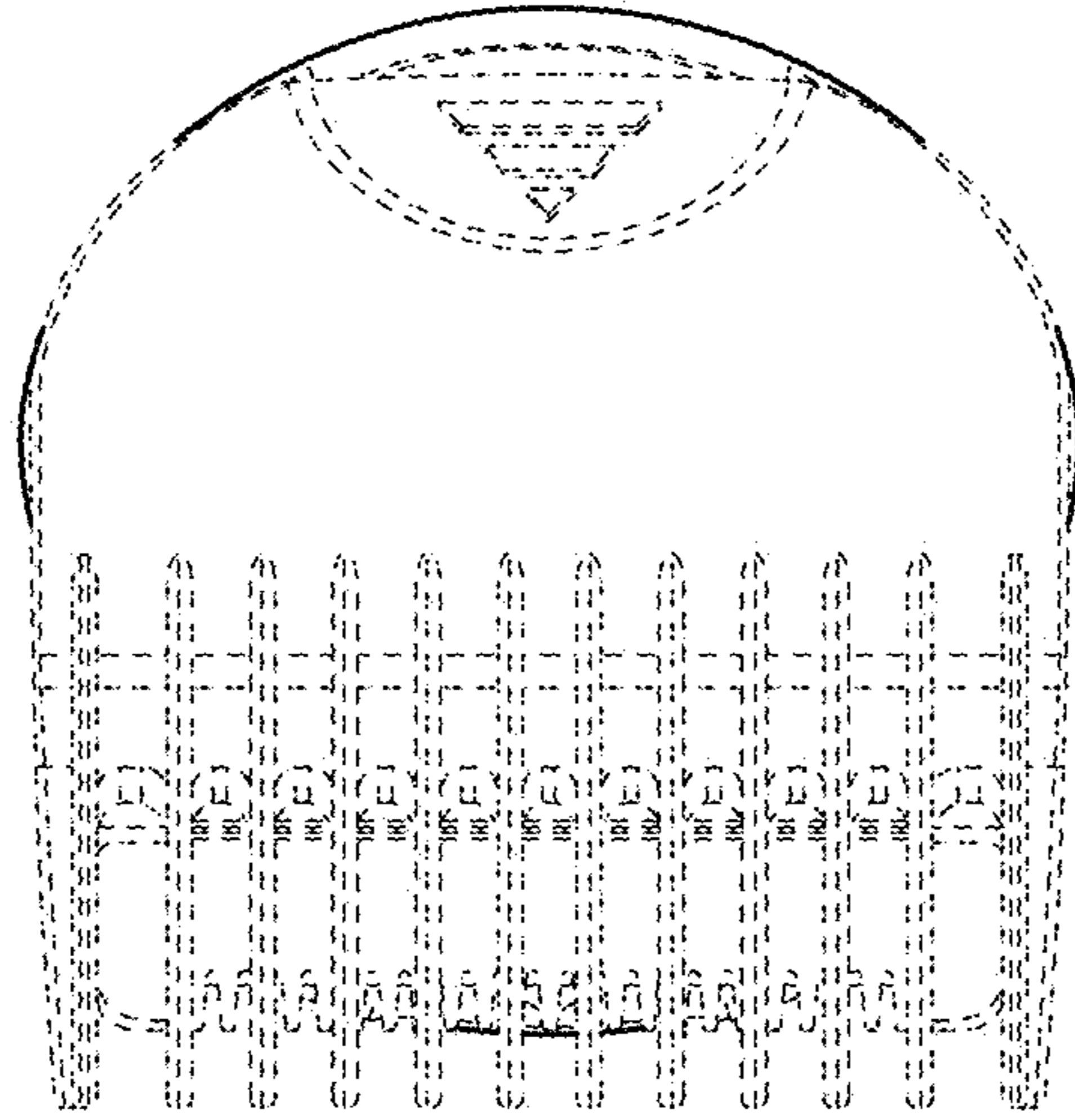

FIG. 34

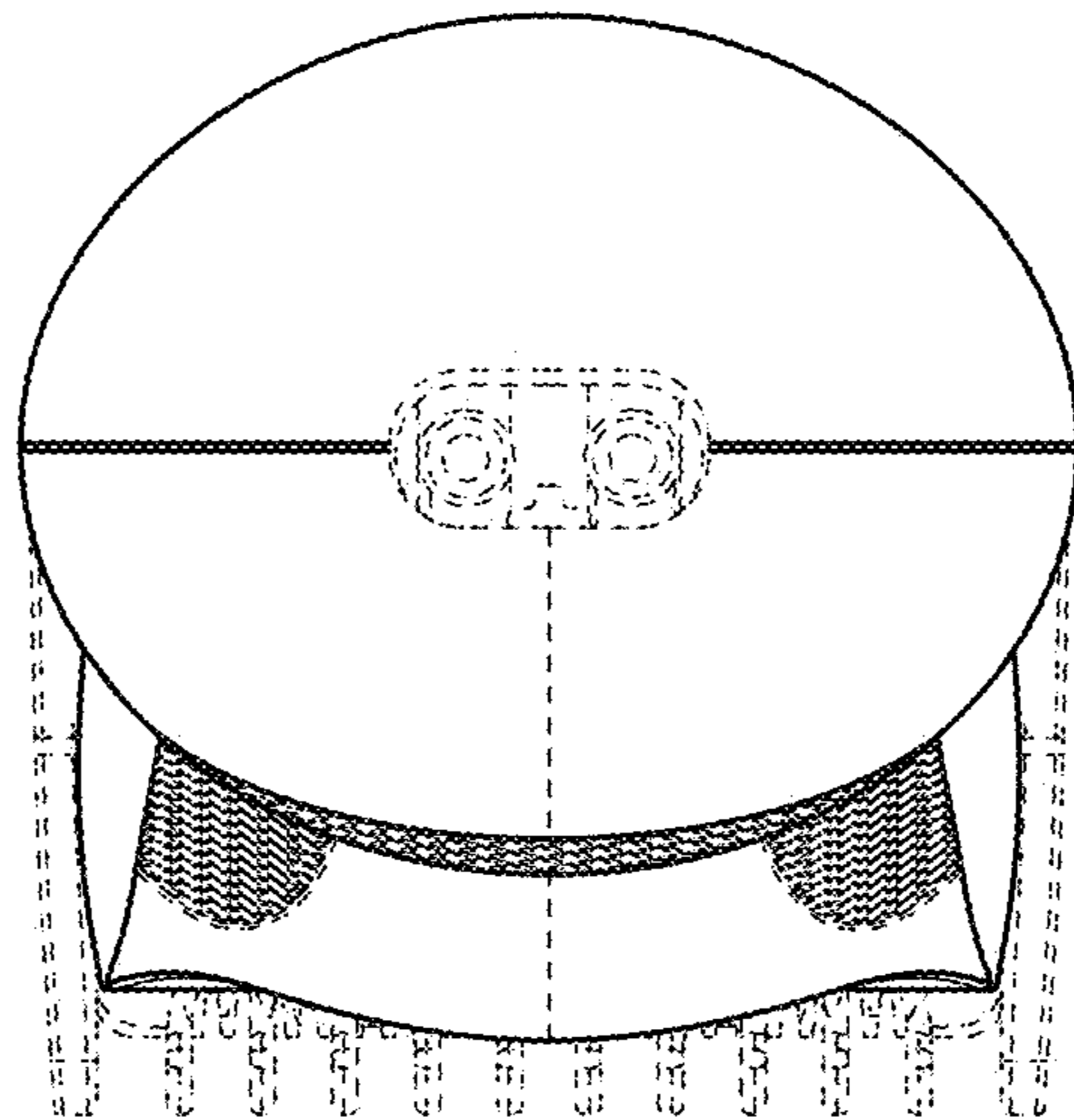

FIG. 35