



US00D955048S

(12) **United States Design Patent** (10) **Patent No.:** **US D955,048 S**  
**Van Roosmalen et al.** (45) **Date of Patent:** **\*\* Jun. 14, 2022**

(54) **HANDLE FOR SHAVER**  
(71) Applicant: **KONINKLIJKE PHILIPS N.V.**,  
Eindhoven (NL)  
(72) Inventors: **Jos Van Roosmalen**, Amsterdam (NL);  
**Frank Verbrugge**, Rosmalen (NL);  
**Jens Andersson**, Amsterdam (NL);  
**Roel Krooshof**, Bilthoven (NL); **Simon**  
**Van Anken**, Amsterdam (NL); **Peter**  
**Gal**, Amsterdam (NL); **Lieven**  
**Adriaenssen**, Vilvoorde (BE); **Roshan**  
**Hakkim**, Amsterdam (NL); **Mingshuo**  
**Zhang**, Amstelveen (NL)

D777,375 S \* 1/2017 Frankel ..... D28/50  
D777,376 S \* 1/2017 Frankel ..... D28/50  
9,919,437 B2 \* 3/2018 Veltman ..... B26B 19/388  
D848,072 S \* 5/2019 Prat-Pfister ..... D28/50  
10,357,890 B2 \* 7/2019 Yan ..... B26B 19/3866  
10,471,612 B2 \* 11/2019 Shimizu ..... B26B 19/146  
D880,064 S \* 3/2020 Andersson ..... D28/50  
D884,972 S \* 5/2020 Andersson ..... D28/50  
D889,042 S \* 6/2020 Andersson ..... D28/50  
10,926,425 B2 \* 2/2021 Zak ..... B26B 19/3846  
D912,902 S \* 3/2021 Andersson ..... D28/50  
D914,290 S \* 3/2021 Kulshreshtha ..... D28/50  
10,946,536 B2 \* 3/2021 Winters ..... B26B 19/146  
D932,697 S \* 10/2021 Van Roosmalen ..... D28/50  
D932,698 S \* 10/2021 Van Roosmalen ..... D28/50  
D932,699 S \* 10/2021 Van Roosmalen ..... D28/50

(Continued)

(73) Assignee: **KONINKLIJKE PHILIPS N.V.**,  
Eindhoven (NL)

*Primary Examiner* — Jennifer Rivard

(\*\*) Term: **15 Years**

(57) **CLAIM**

(21) Appl. No.: **29/810,240**

The ornamental design for a handle for shaver, as shown and described.

(22) Filed: **Oct. 4, 2021**

**DESCRIPTION**

**Related U.S. Application Data**

(62) Division of application No. 29/723,216, filed on Feb. 5, 2020, now Pat. No. Des. 932,697.

(51) **LOC (13) Cl.** ..... **28-03**

(52) **U.S. Cl.**  
USPC ..... **D28/50; D28/54**

(58) **Field of Classification Search**  
USPC ..... D28/49–54  
CPC ..... B26B 19/14–18; B26B 19/38; B26B  
19/3853–3893; B26B 19/3806–384  
See application file for complete search history.

FIG. 1 is a perspective view showing the first embodiment of a handle for shaver;  
FIG. 2 is a front elevational view thereof;  
FIG. 3 is a rear elevational view thereof;  
FIG. 4 is a right side elevational view thereof;  
FIG. 5 is a left side elevational view thereof;  
FIG. 6 is a top plan view thereof;  
FIG. 7 is a bottom plan view thereof;  
FIG. 8 is a perspective view showing the second embodiment of a handle for shaver;  
FIG. 9 is a front elevational view thereof;  
FIG. 10 is a rear elevational view thereof;  
FIG. 11 is a right side elevational view thereof;  
FIG. 12 is a left side elevational view thereof;  
FIG. 13 is a top plan view thereof; and,  
FIG. 14 is a bottom plan view thereof.

(56) **References Cited**

**U.S. PATENT DOCUMENTS**

D758,014 S \* 5/2016 Smith ..... D28/50  
D758,017 S \* 5/2016 Smith ..... D28/54

**1 Claim, 12 Drawing Sheets**

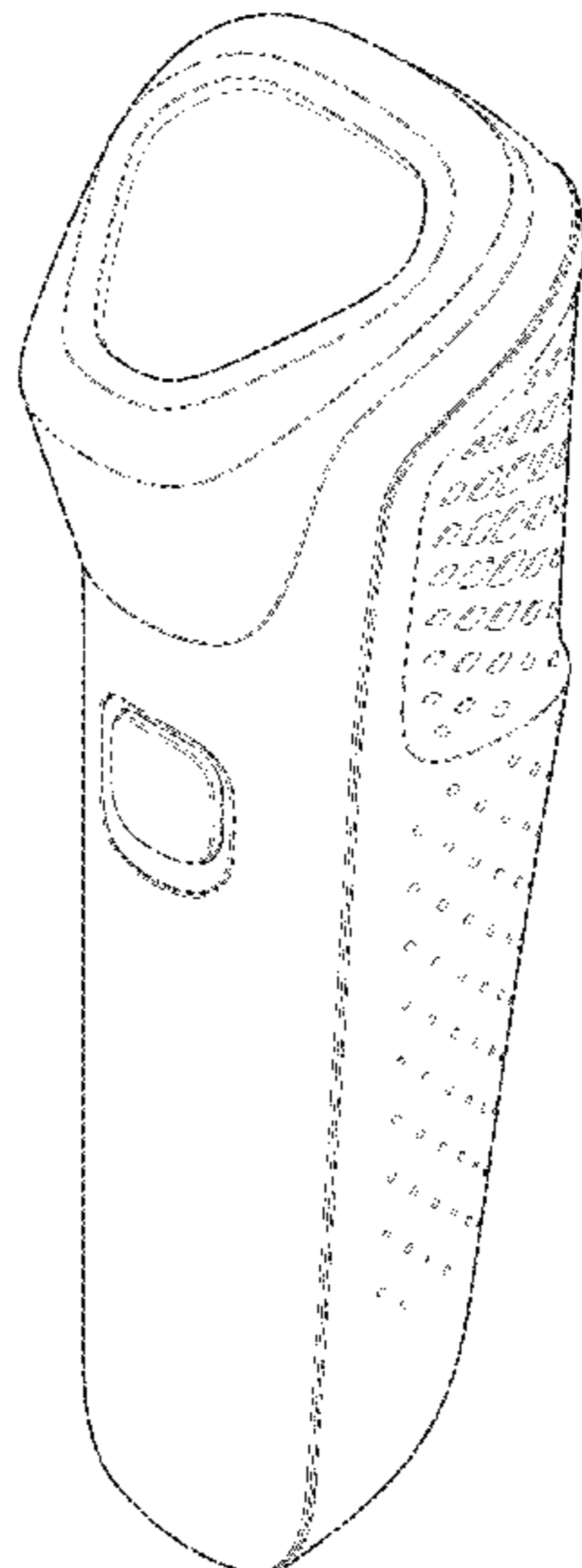

(56)

**References Cited**

U.S. PATENT DOCUMENTS

D932,700 S \* 10/2021 Van Roosmalen ..... D28/50  
D933,894 S \* 10/2021 Van Roosmalen ..... D28/50  
D934,502 S \* 10/2021 Van Roosmalen ..... D28/50  
2021/0069920 A1\* 3/2021 Kulshreshtha ..... B26B 19/386

\* cited by examiner

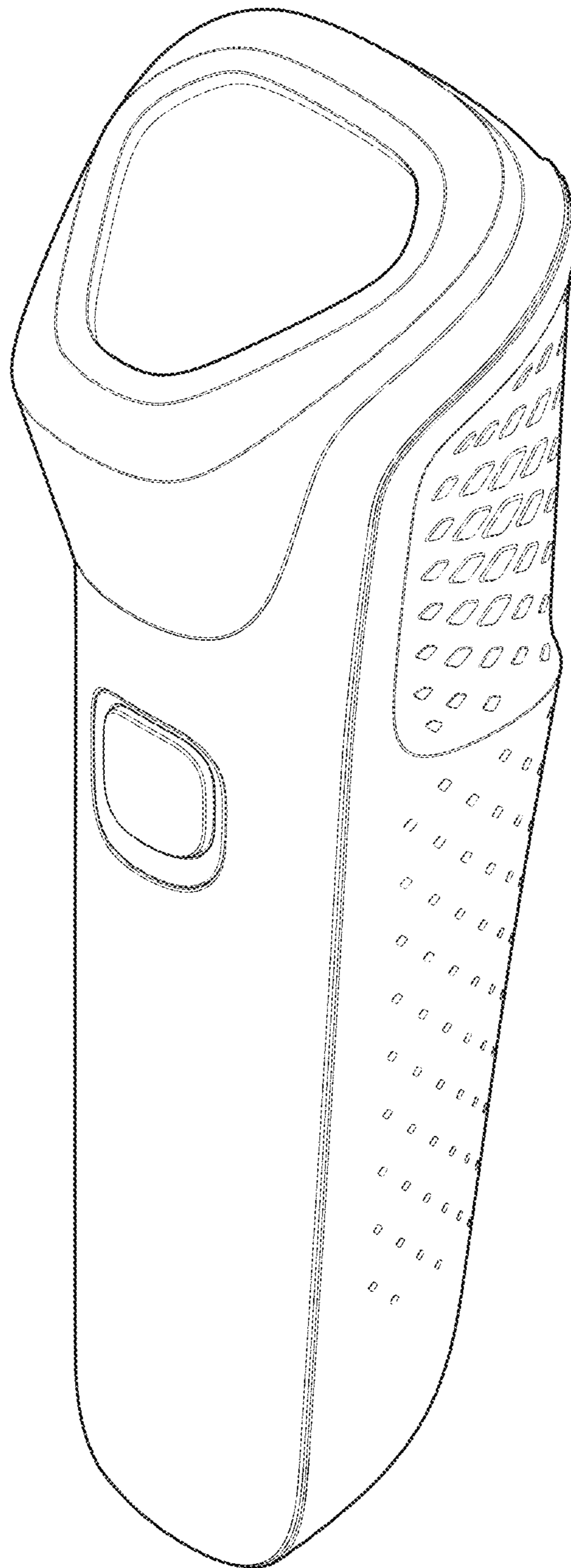

FIG. 1

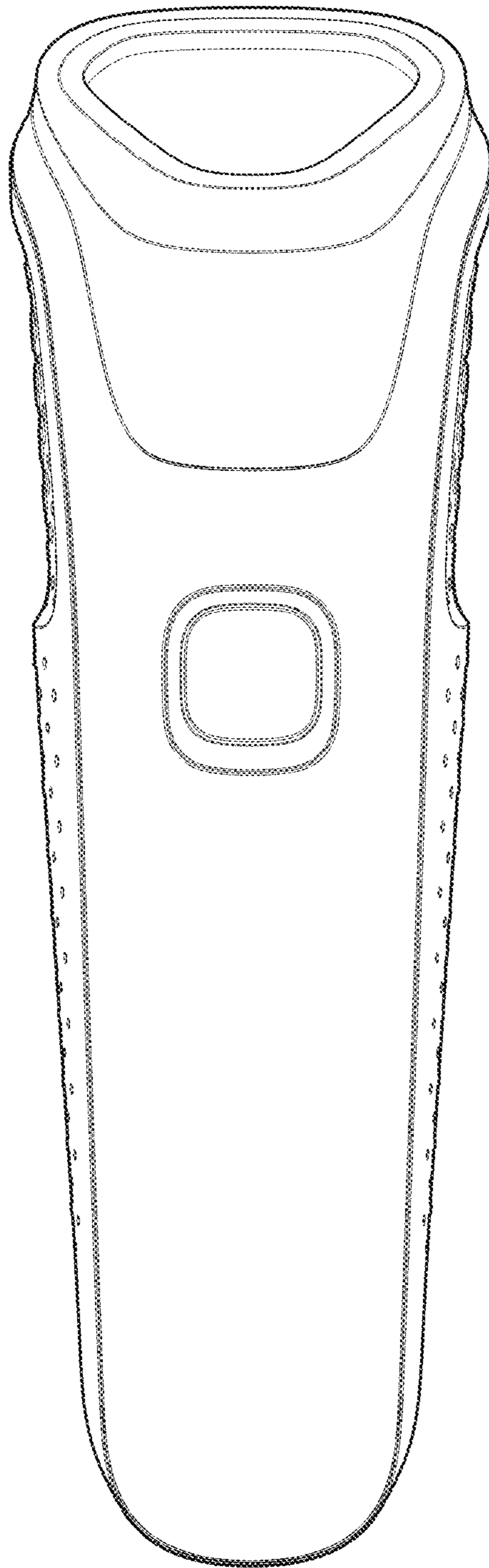

FIG. 2

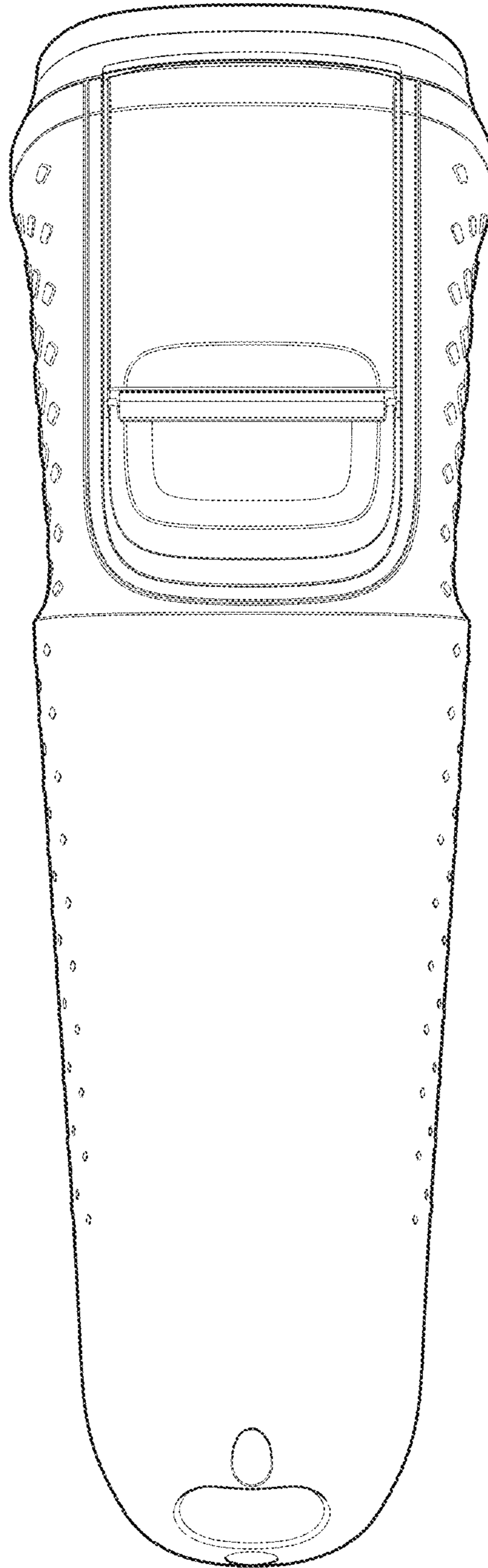

FIG. 3

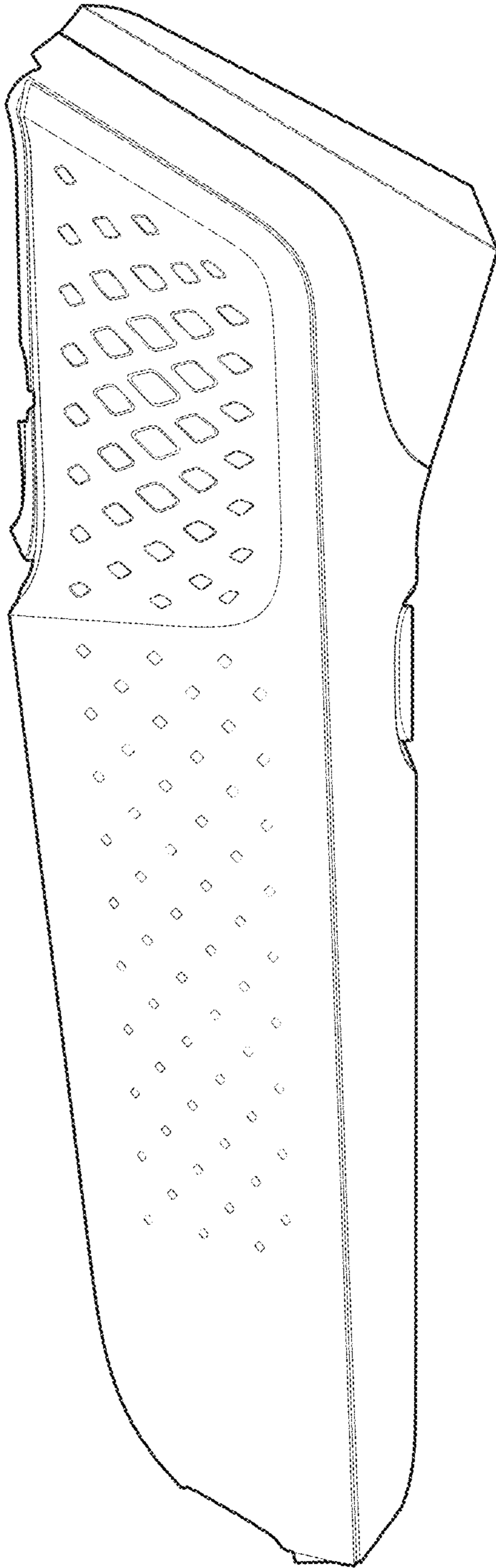

FIG. 4

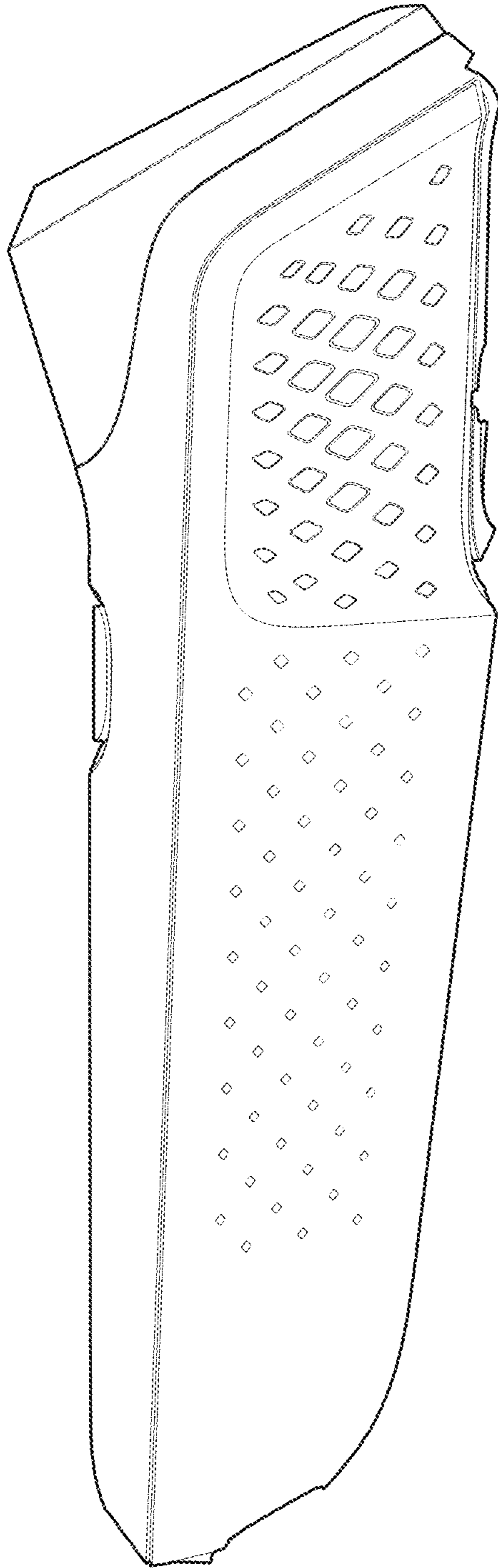

FIG. 5

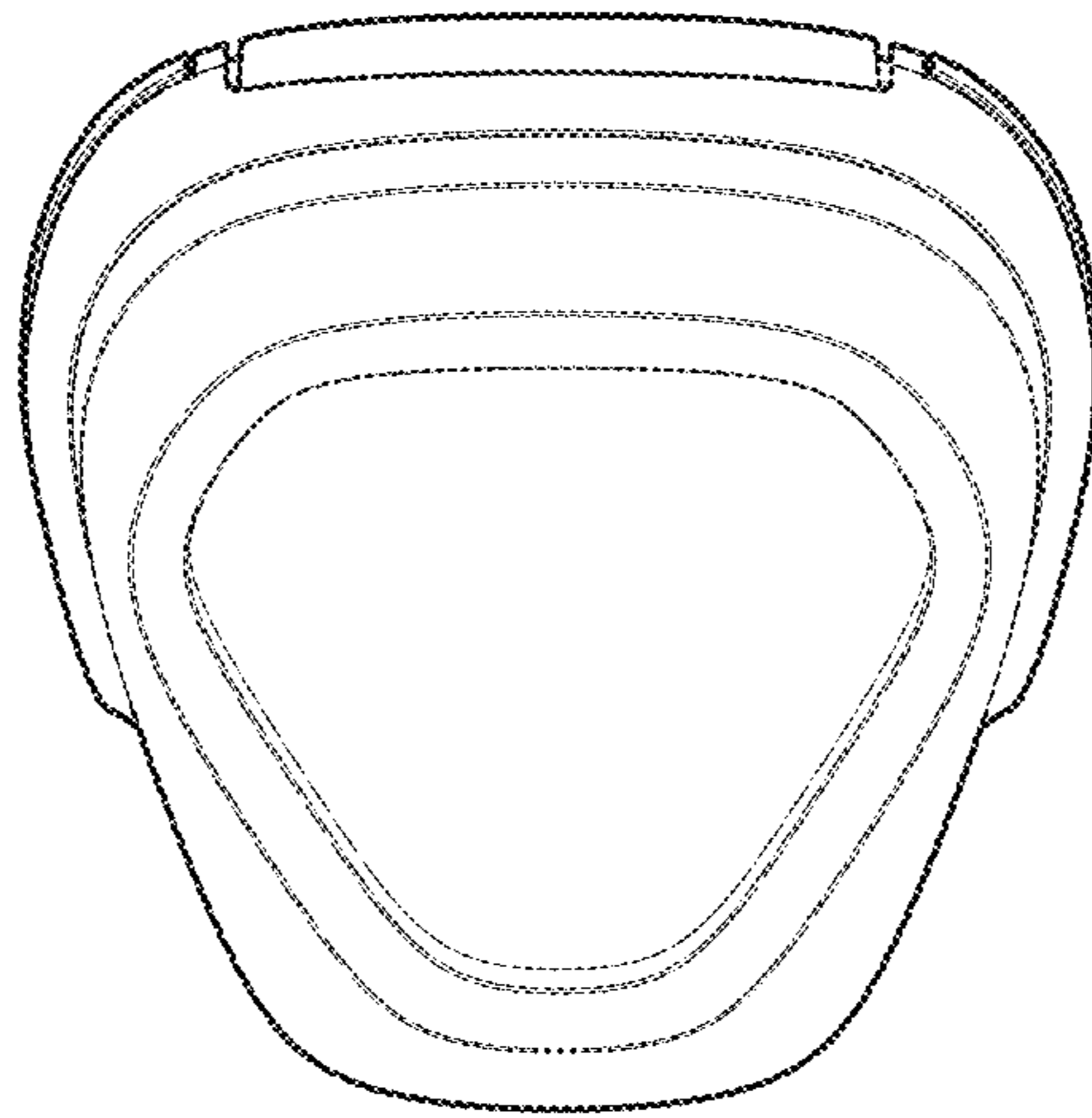

FIG. 6

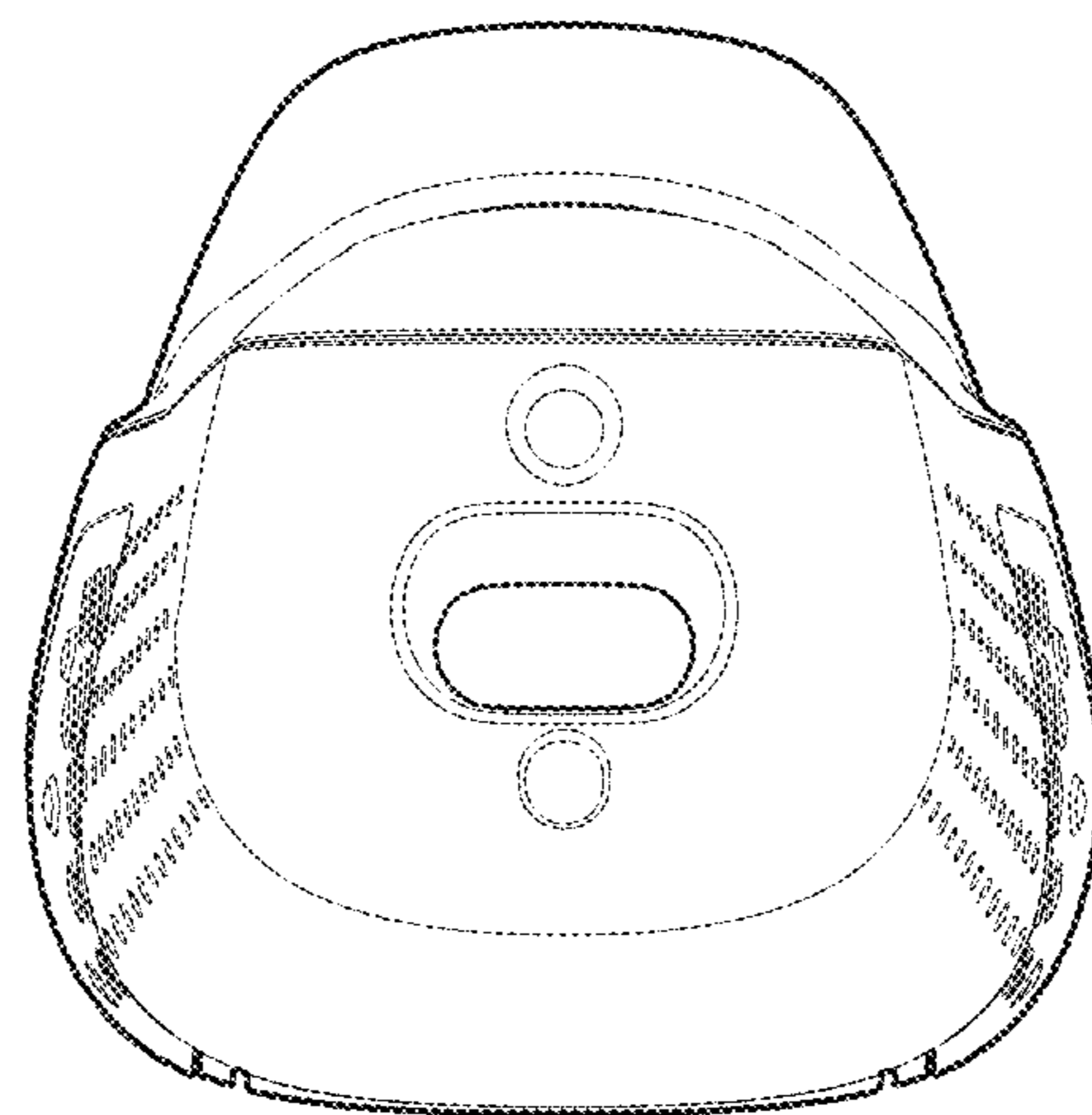

FIG. 7



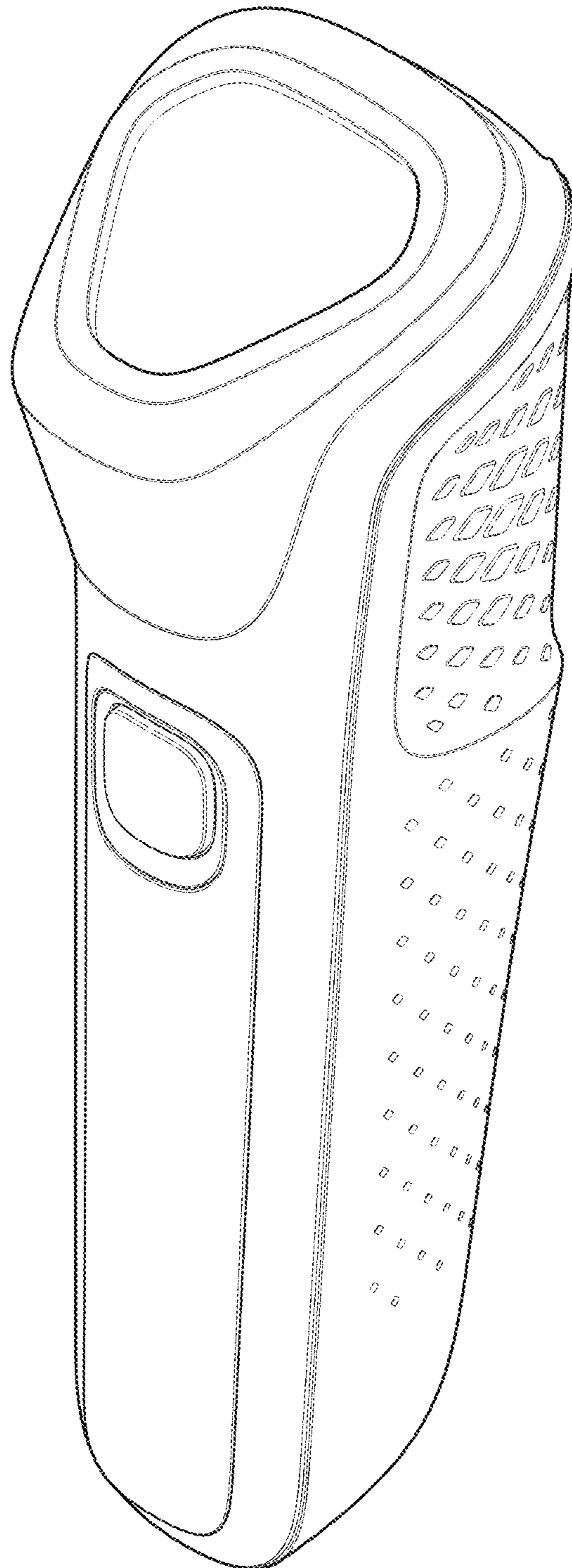

FIG. 8

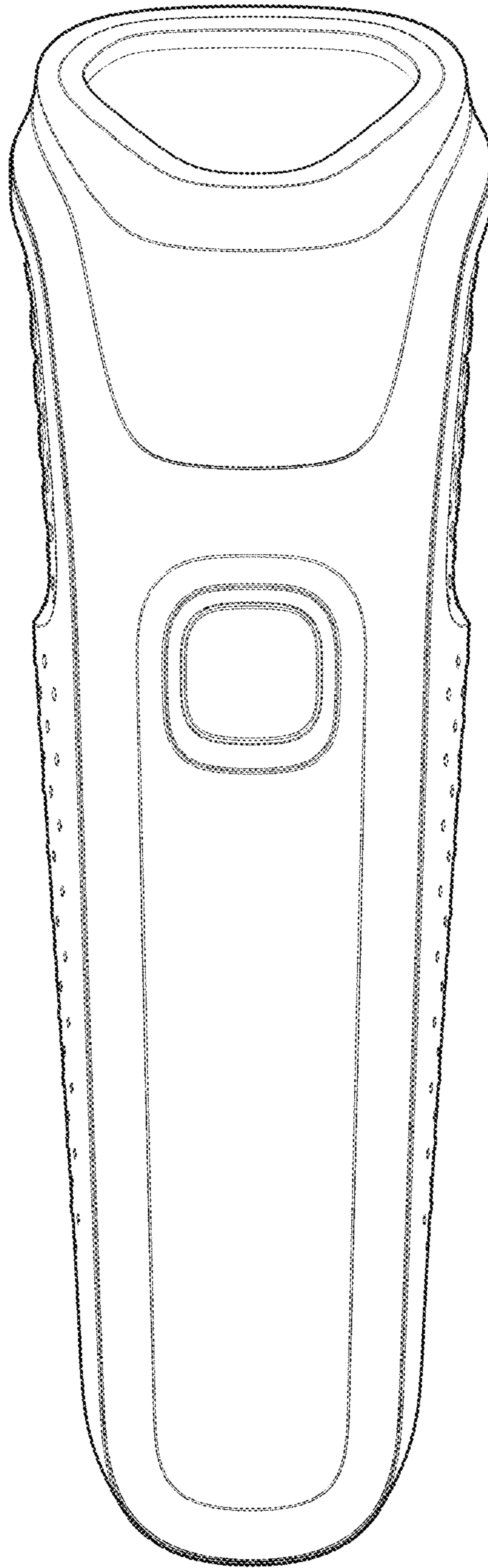

FIG. 9

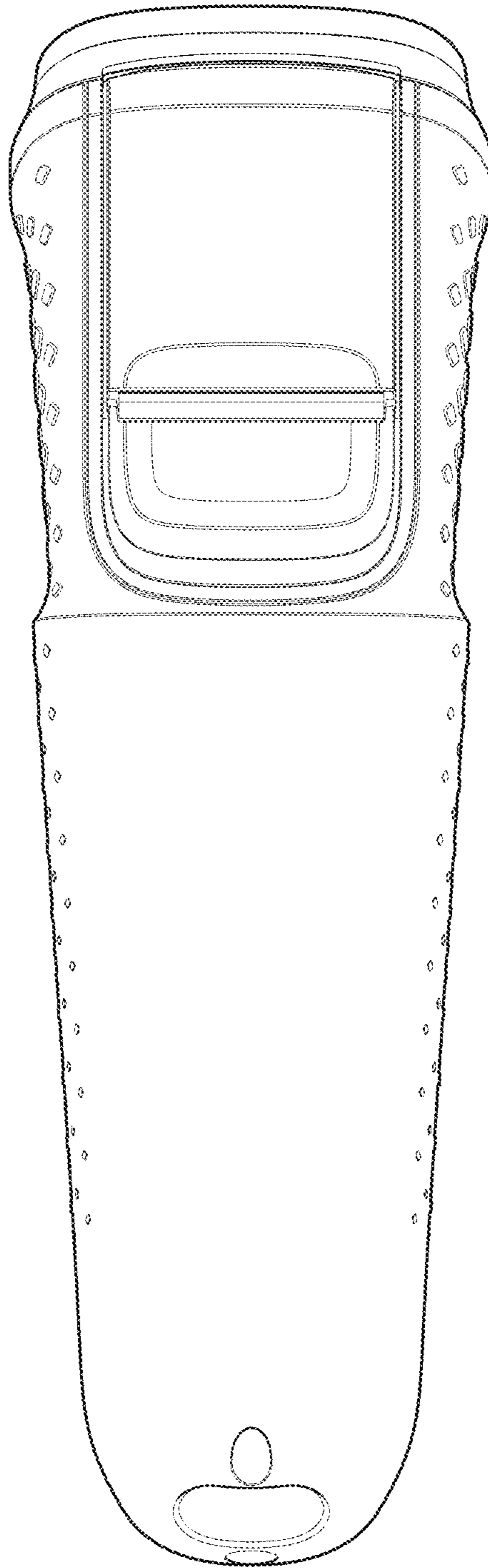

FIG. 10

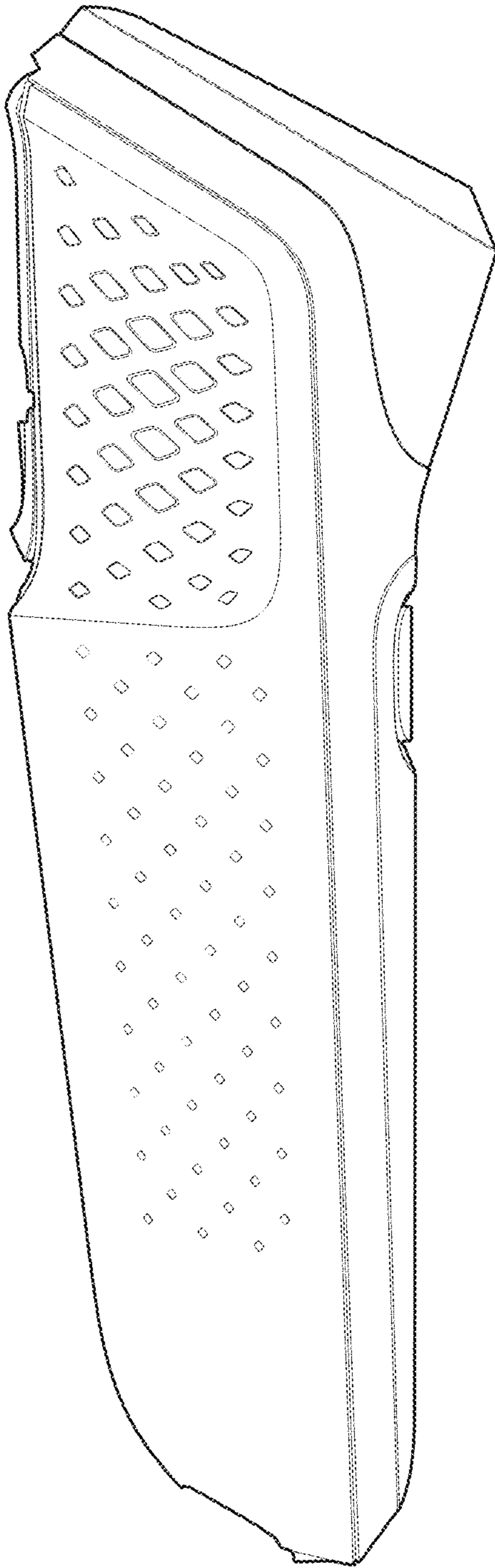

FIG. 11

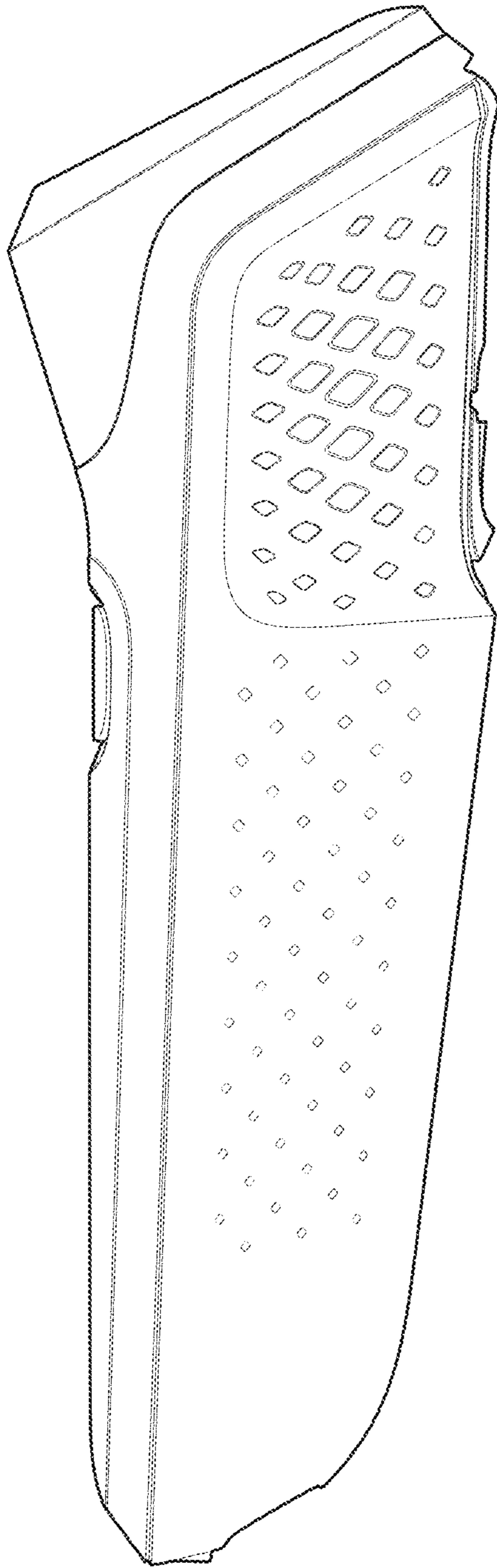

FIG. 12

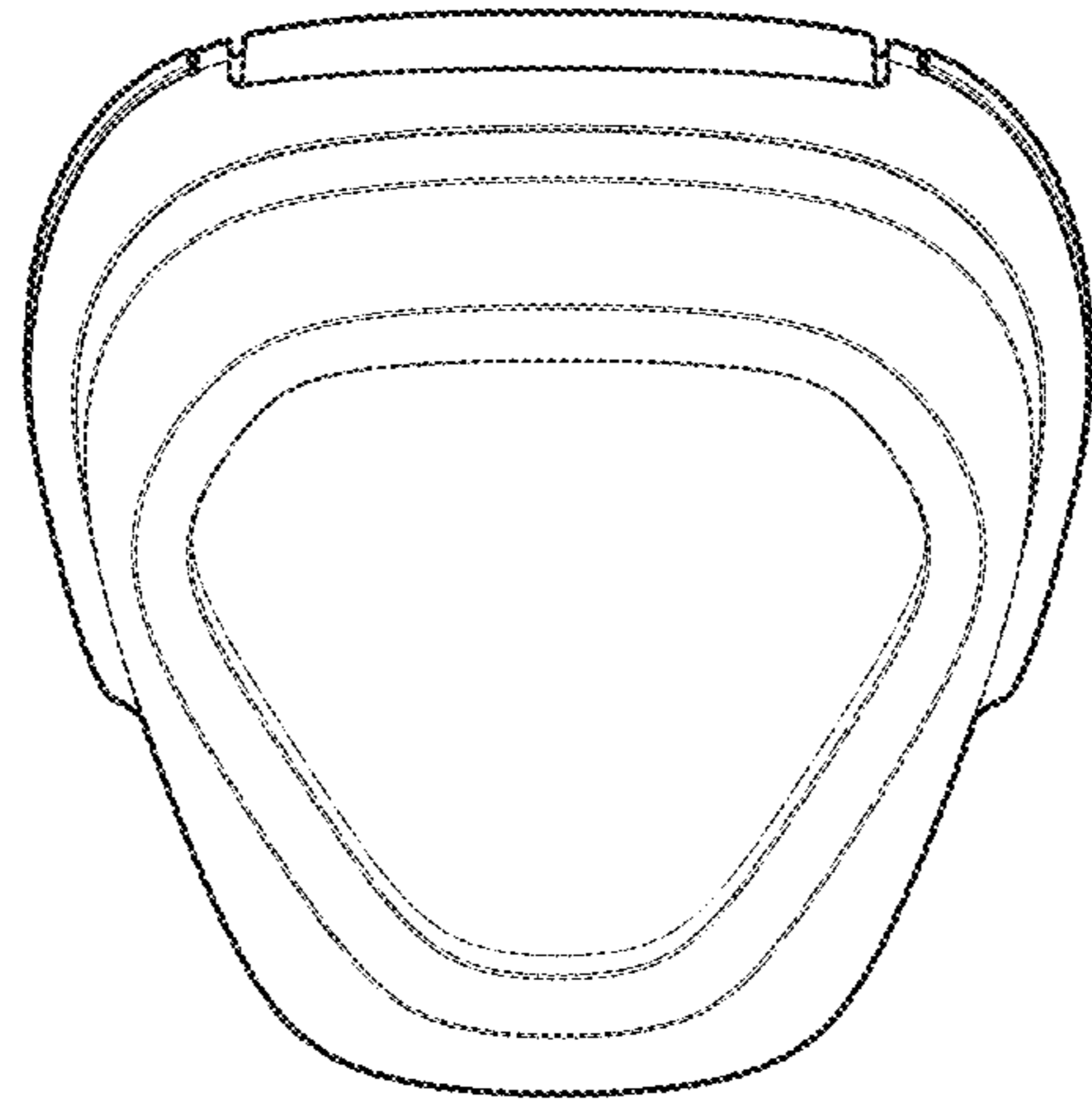

FIG. 13

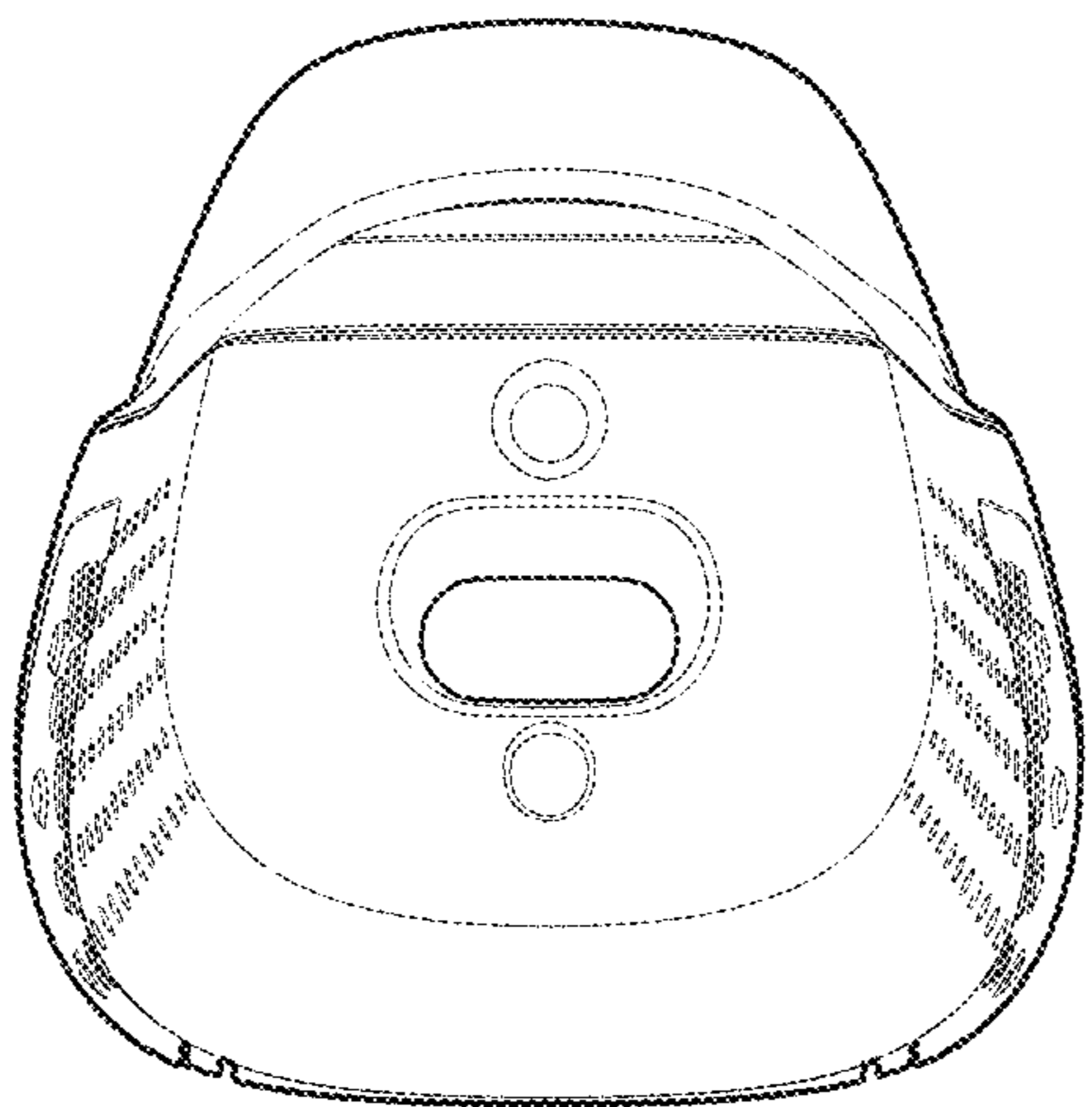

FIG. 14