



US00D955047S

(12) **United States Design Patent** (10) **Patent No.:** **US D955,047 S**  
**Parambathkandi Abdulhakkim et al.** (45) **Date of Patent:** **\*\* Jun. 14, 2022**

(54) **SHAVER HANDLE**

*Primary Examiner* — Jennifer Rivard

(71) Applicant: **KONINKLIJKE PHILIPS N.V.**,  
Eindhoven (NL)

(57) **CLAIM**

The ornamental design for a shaver handle, as shown and described.

(72) Inventors: **Roshan Ali Hakkim Parambathkandi Abdulhakkim**, Utrecht (NL); **Roeland Gerard Krooshof**, Bilthoven (NL)

**DESCRIPTION**

(73) Assignee: **KONINKLIJKE PHILIPS N.V.**,  
Eindhoven (NL)

(\*\*) Term: **15 Years**

(21) Appl. No.: **29/706,656**

(22) Filed: **Sep. 23, 2019**

(30) **Foreign Application Priority Data**

Mar. 21, 2019 (EM) ..... 006316832-0007

(51) **LOC (13) Cl.** ..... **28-03**

(52) **U.S. Cl.**  
USPC ..... **D28/50**; D28/54

(58) **Field of Classification Search**  
USPC ..... D28/49–54  
CPC ..... B26B 19/14–18; B26B 19/38; B26B  
19/3853–3893; B26B 19/3806–384  
See application file for complete search history.

(56) **References Cited**

**U.S. PATENT DOCUMENTS**

D367,944 S *	3/1996	Izumi	.....	D28/50
D383,566 S *	9/1997	Bone	.....	D28/50
D389,273 S *	1/1998	Bone	.....	D28/50
D389,276 S *	1/1998	Bone	.....	D28/50
D405,922 S *	2/1999	Bone	.....	D28/50
D698,491 S *	1/2014	Ellison	.....	D28/50
D748,857 S *	2/2016	Boulanger	.....	D28/50

(Continued)

FIG. 1 is a perspective view showing the first embodiment of our design;  
 FIG. 2 is a front elevational view thereof;  
 FIG. 3 is a rear elevational view thereof;  
 FIG. 4 is a right side elevational view thereof;  
 FIG. 5 is a left side elevational view thereof;  
 FIG. 6 is a top plan view thereof;  
 FIG. 7 is a bottom plan view thereof;  
 FIG. 8 is a perspective view showing the second embodiment of our design;  
 FIG. 9 is a front elevational view thereof;  
 FIG. 10 is a rear elevational view thereof;  
 FIG. 11 is a right side elevational view thereof;  
 FIG. 12 is a left side elevational view thereof;  
 FIG. 13 is a top plan view thereof;  
 FIG. 14 is a bottom plan view thereof;  
 FIG. 15 is a perspective view showing the third embodiment of our design;  
 FIG. 16 is a front elevational view thereof;  
 FIG. 17 is a rear elevational view thereof;  
 FIG. 18 is a right side elevational view thereof;  
 FIG. 19 is a left side elevational view thereof;  
 FIG. 20 is a top plan view thereof;  
 FIG. 21 is a bottom plan view thereof;  
 FIG. 22 is a perspective view showing the fourth embodiment of our design;  
 FIG. 23 is a front elevational view thereof;  
 FIG. 24 is a rear elevational view thereof;  
 FIG. 25 is a right side elevational view thereof;  
 FIG. 26 is a left side elevational view thereof;  
 FIG. 27 is a top plan view thereof; and,  
 FIG. 28 is a bottom plan view thereof.  
 The broken lines illustrate a portion of the shaver that forms no part of the claimed design.

**1 Claim, 16 Drawing Sheets**

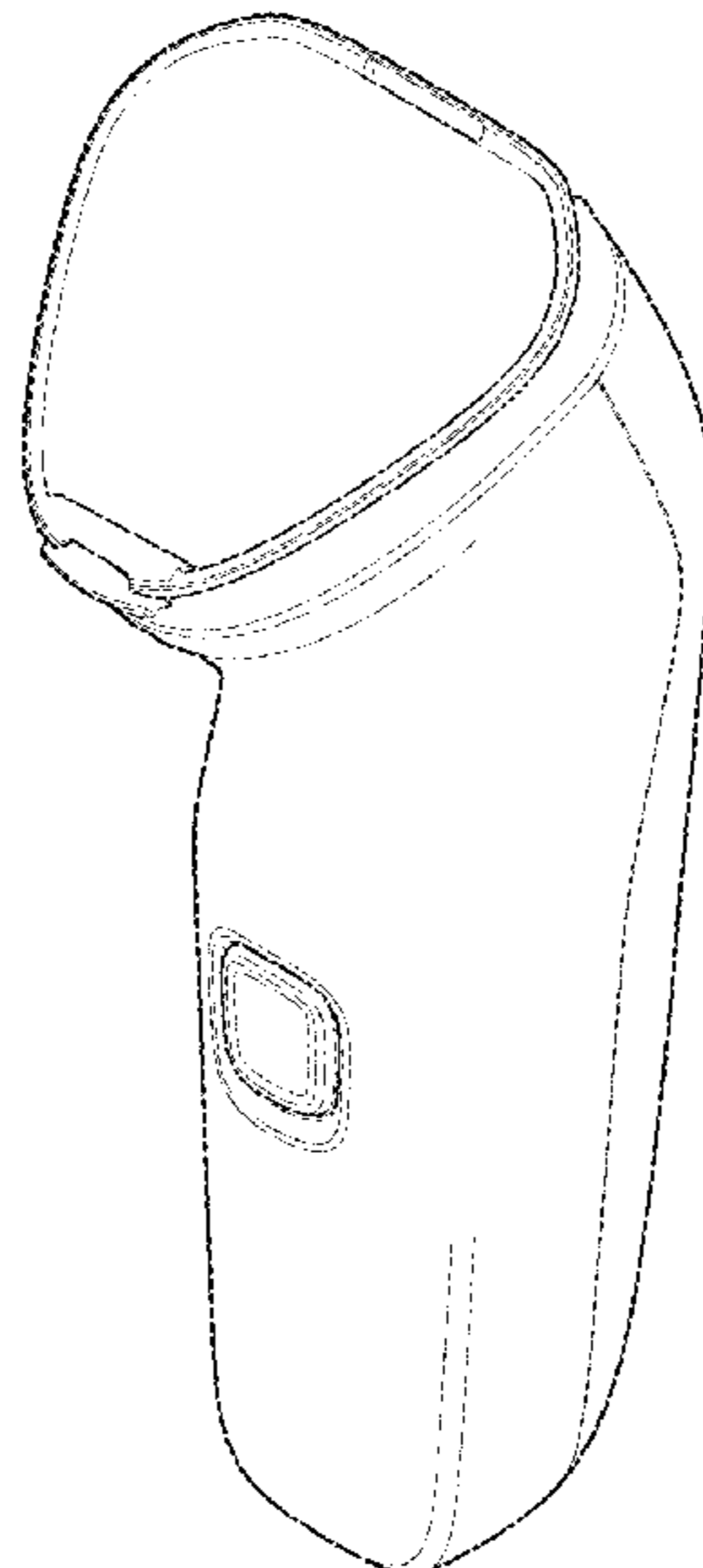

(56)

**References Cited**

U.S. PATENT DOCUMENTS

D758,015	S	*	5/2016	Prat-Pfister	.....	D28/50
D758,017	S	*	5/2016	Smith	.....	D28/54
D758,659	S	*	6/2016	Smith	.....	D28/50
D776,348	S	*	1/2017	Frankel	.....	D28/50
D812,301	S	*	3/2018	Yan	.....	D28/50
D819,274	S	*	5/2018	Yan	.....	D28/50
D823,542	S	*	7/2018	Yan	.....	D28/50
D824,103	S	*	7/2018	Yan	.....	D28/50
D856,583	S	*	8/2019	Chen	.....	D28/50
D880,064	S	*	3/2020	Andersson	.....	D28/50
D912,902	S	*	3/2021	Andersson	.....	D28/50

\* cited by examiner

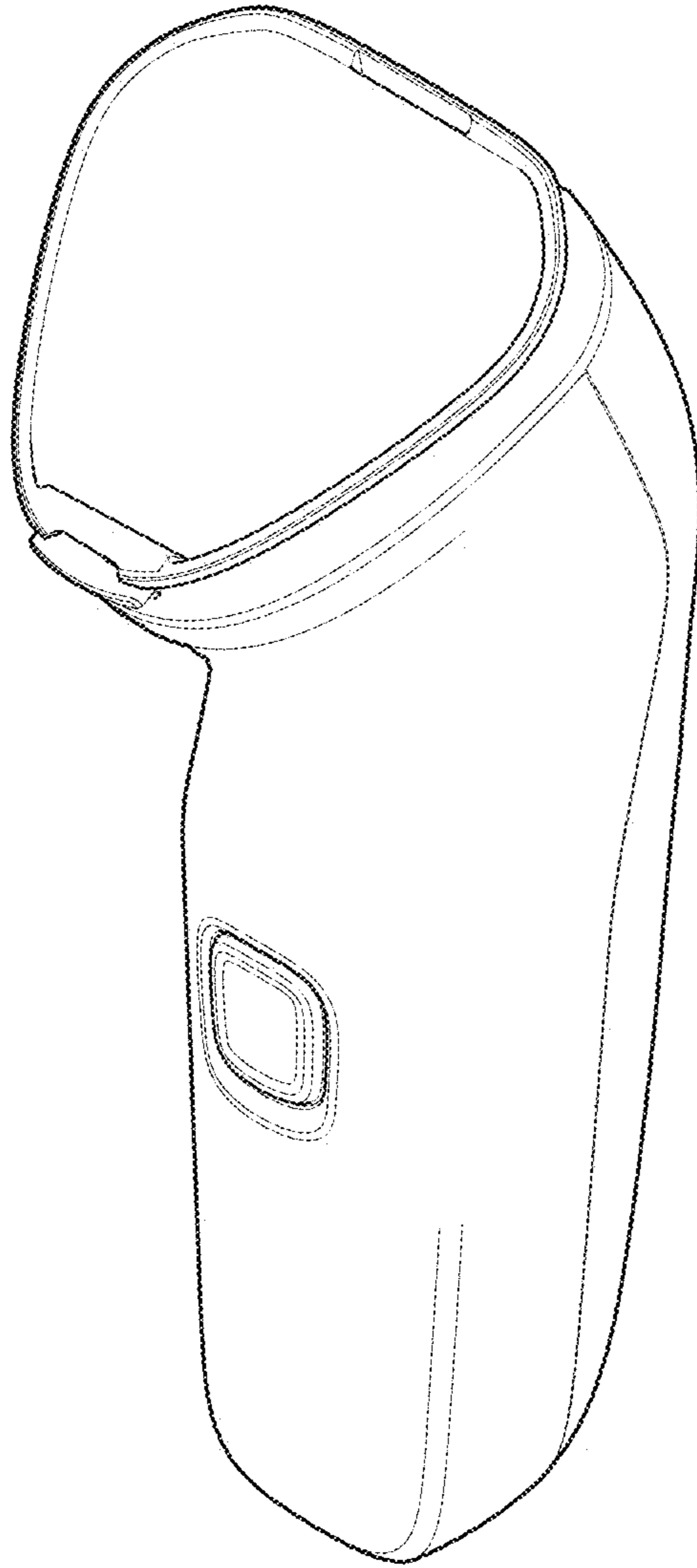

FIG. 1

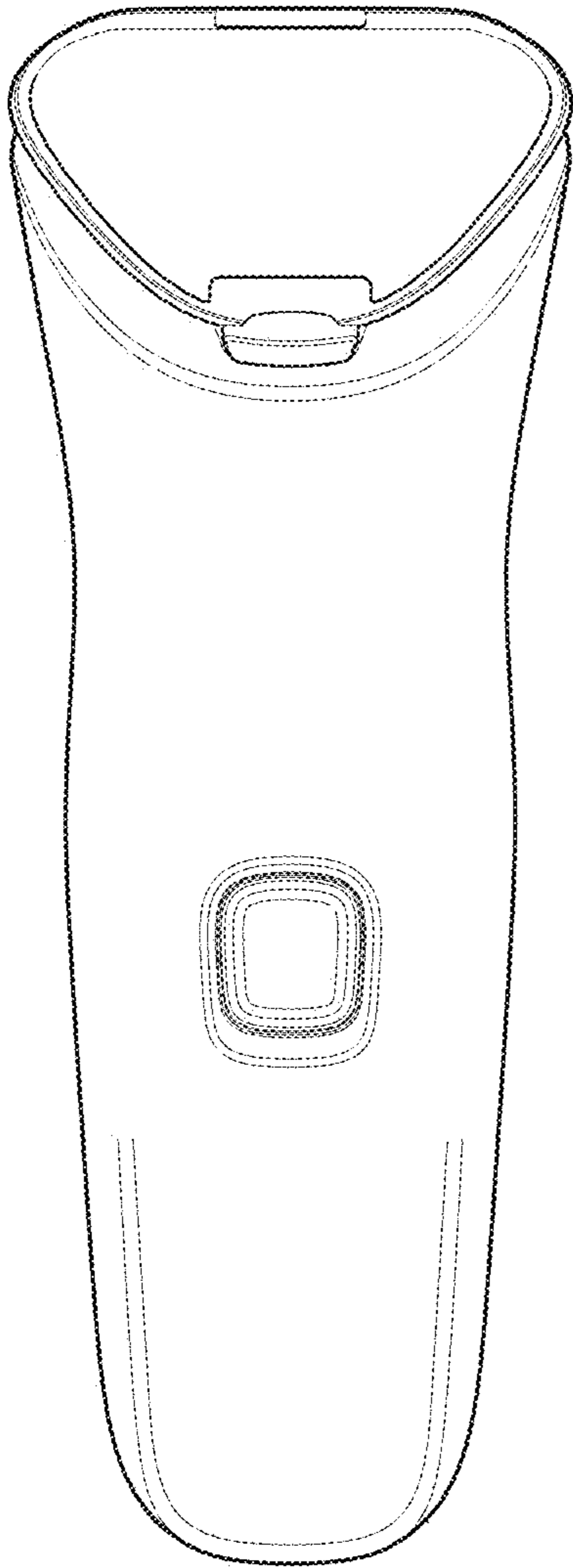

FIG. 2

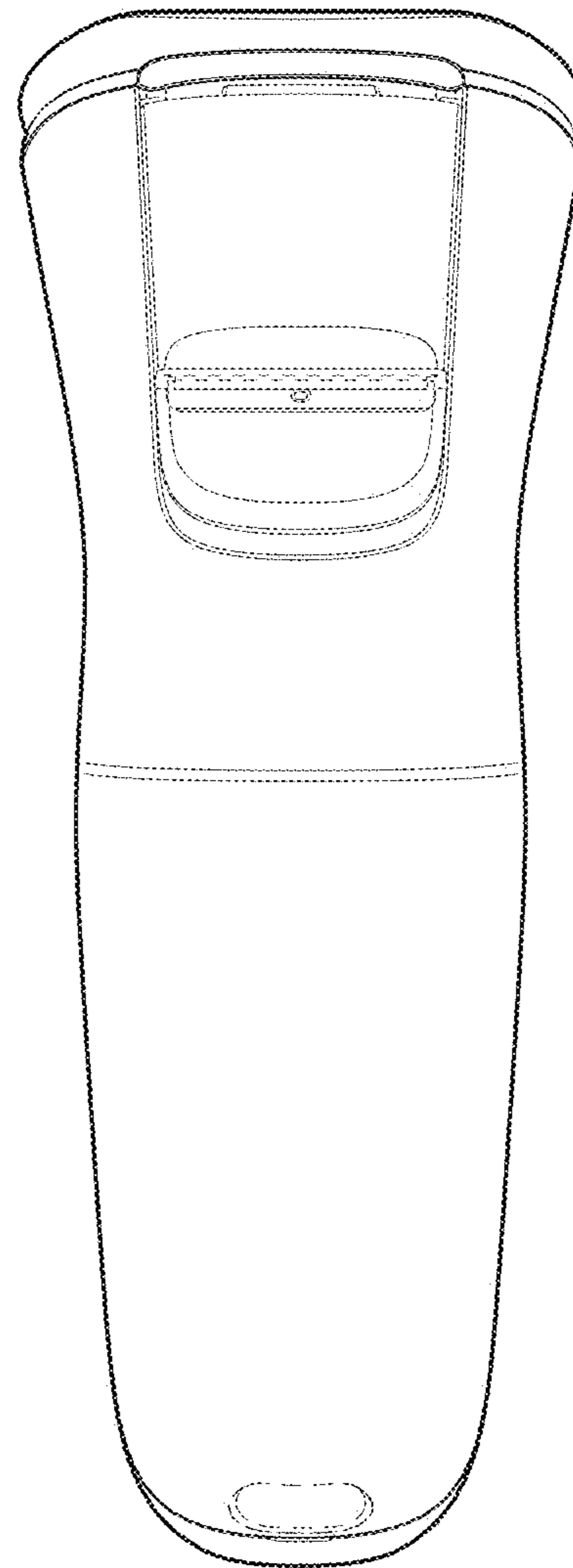

FIG. 3

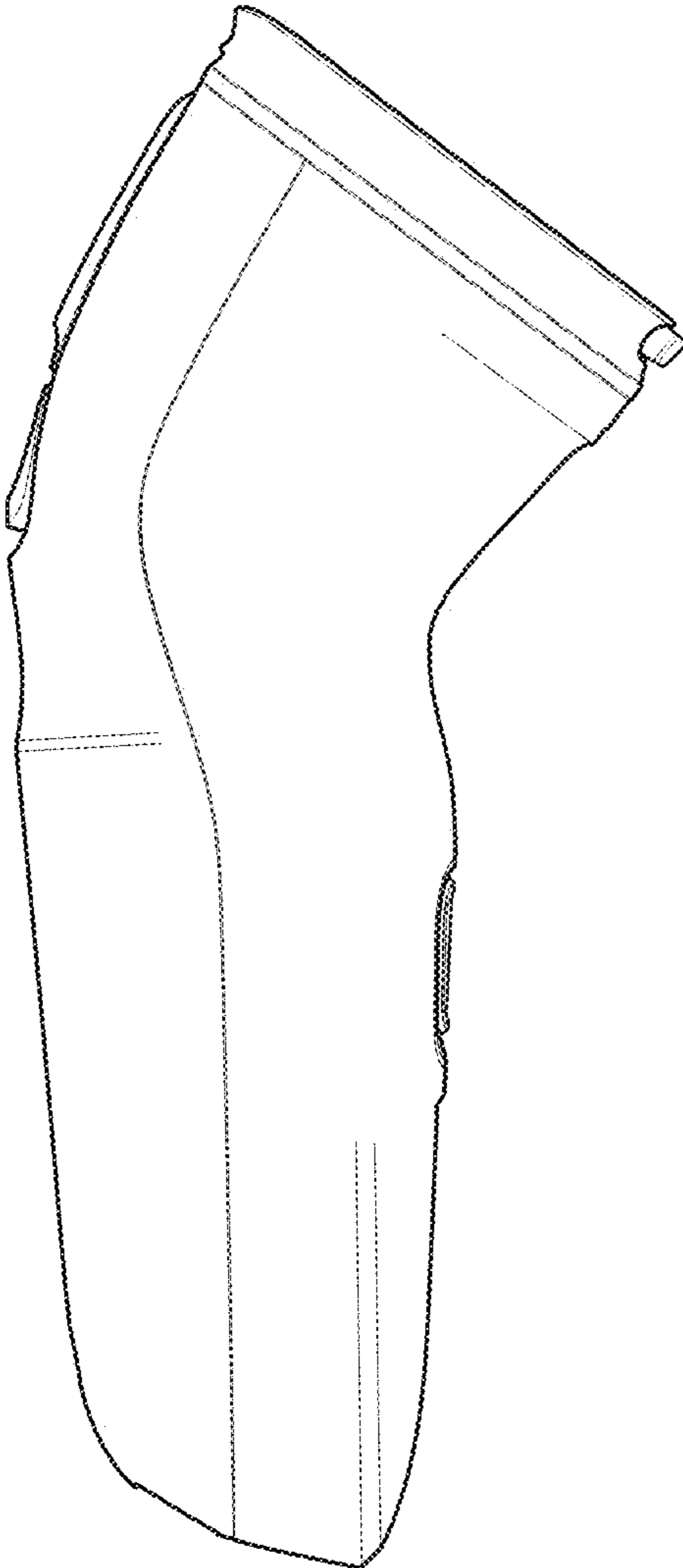

FIG. 4

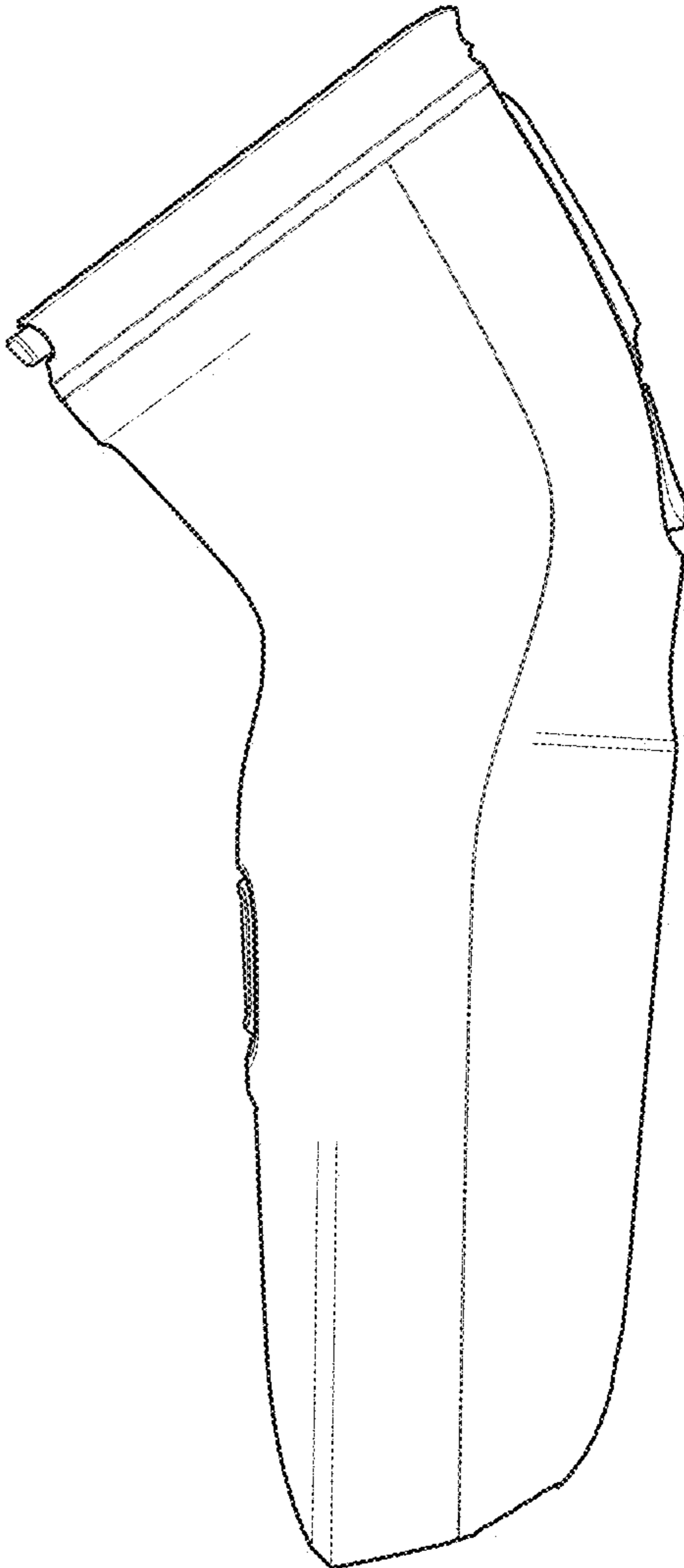

FIG. 5

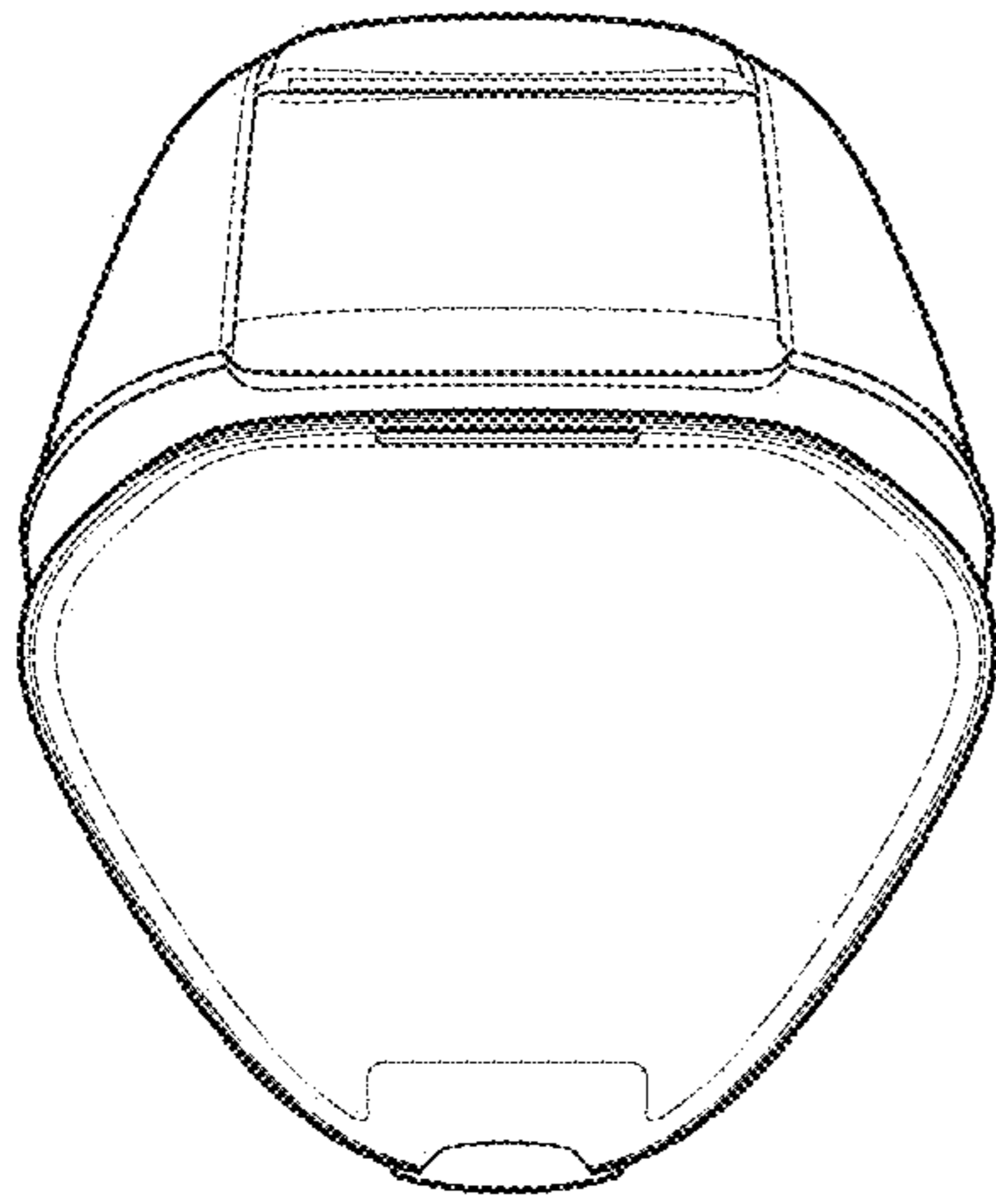

FIG. 6

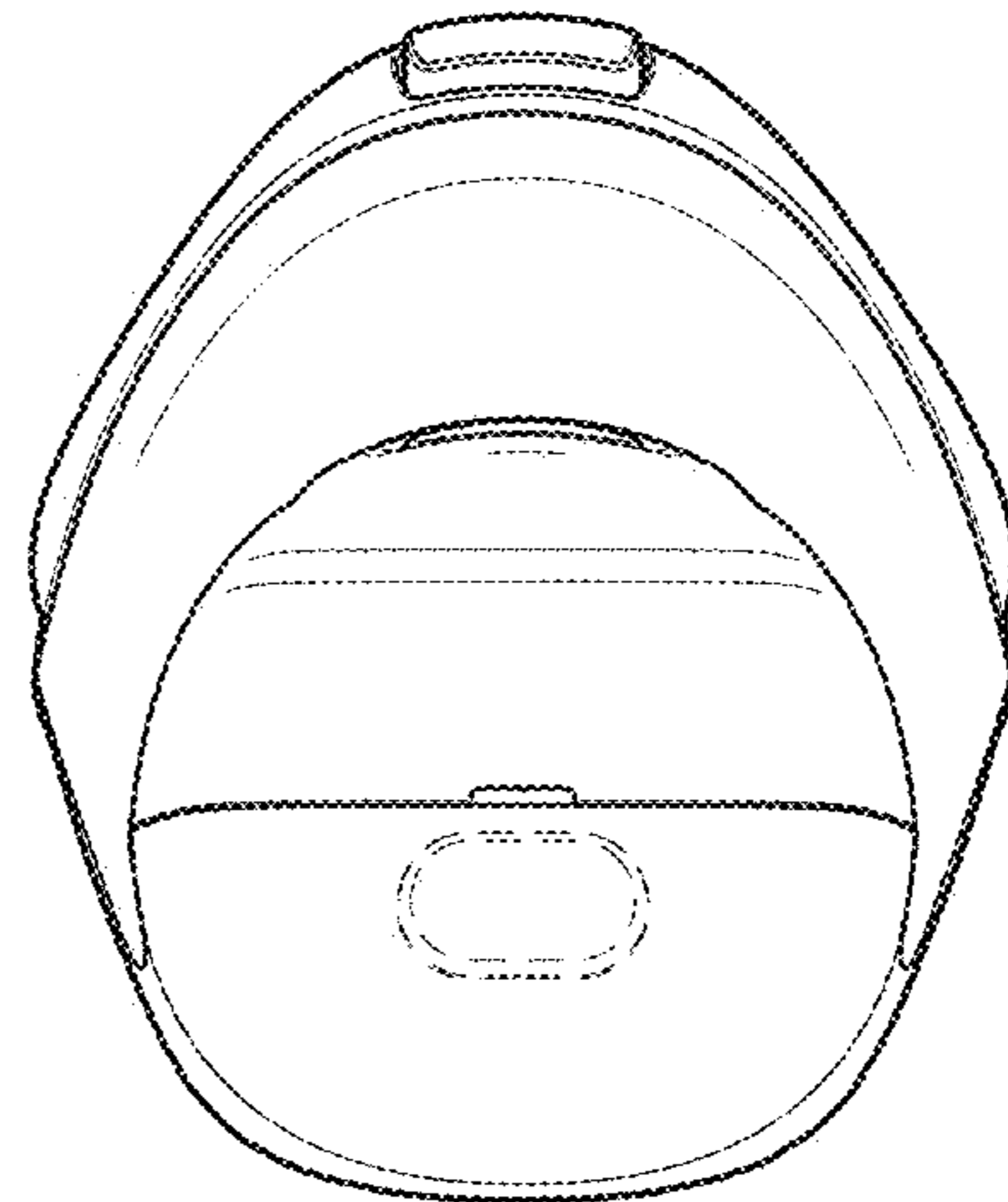

FIG. 7

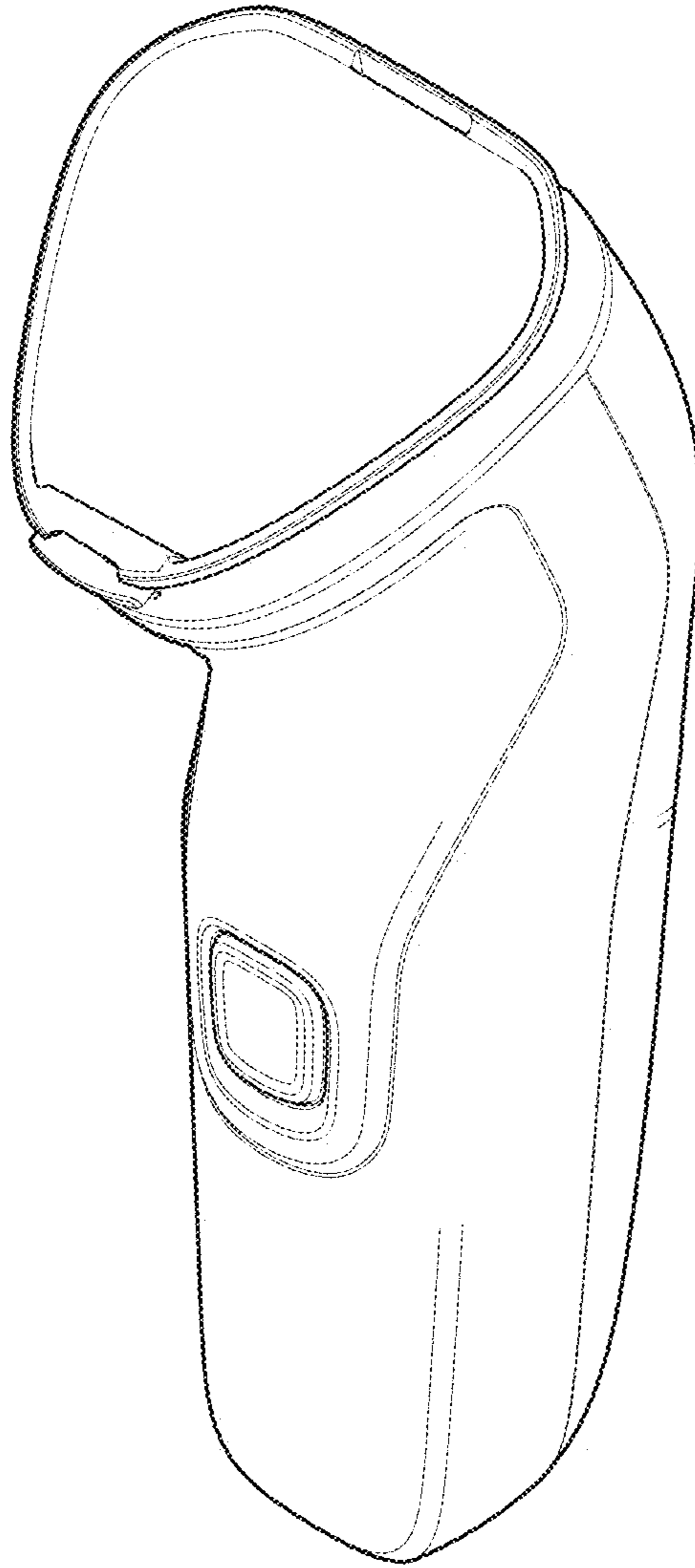

FIG. 8

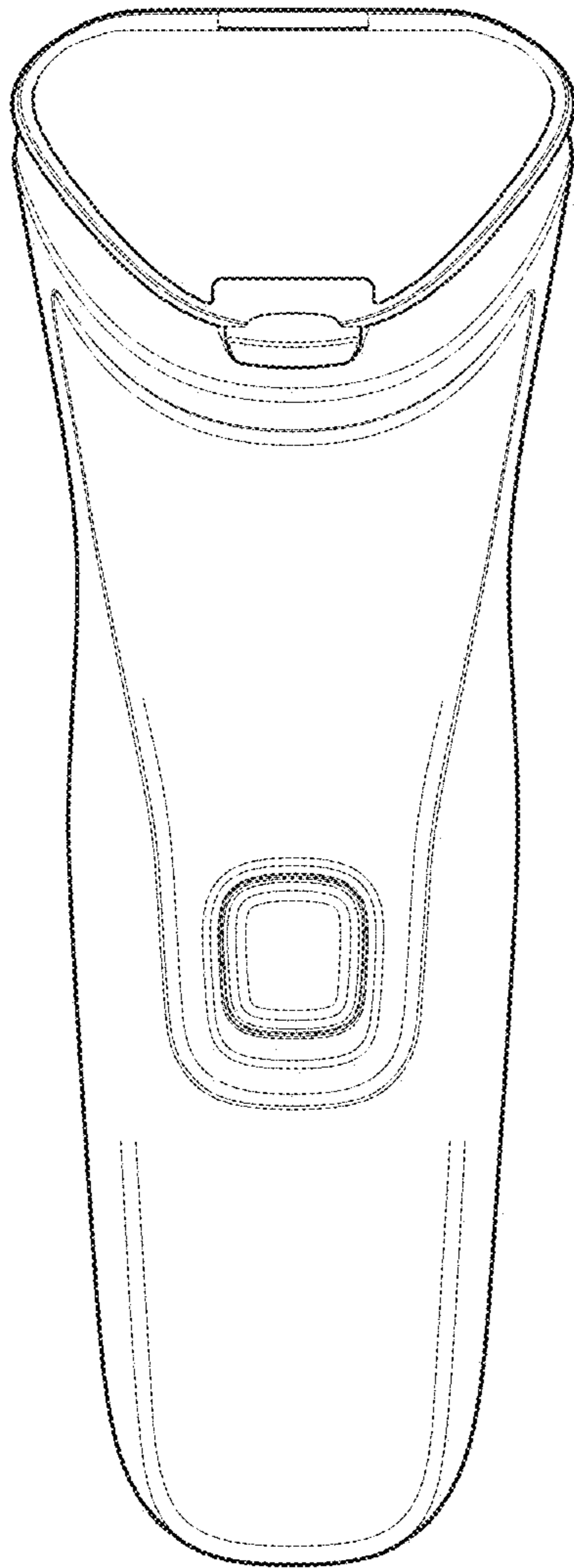

FIG. 9

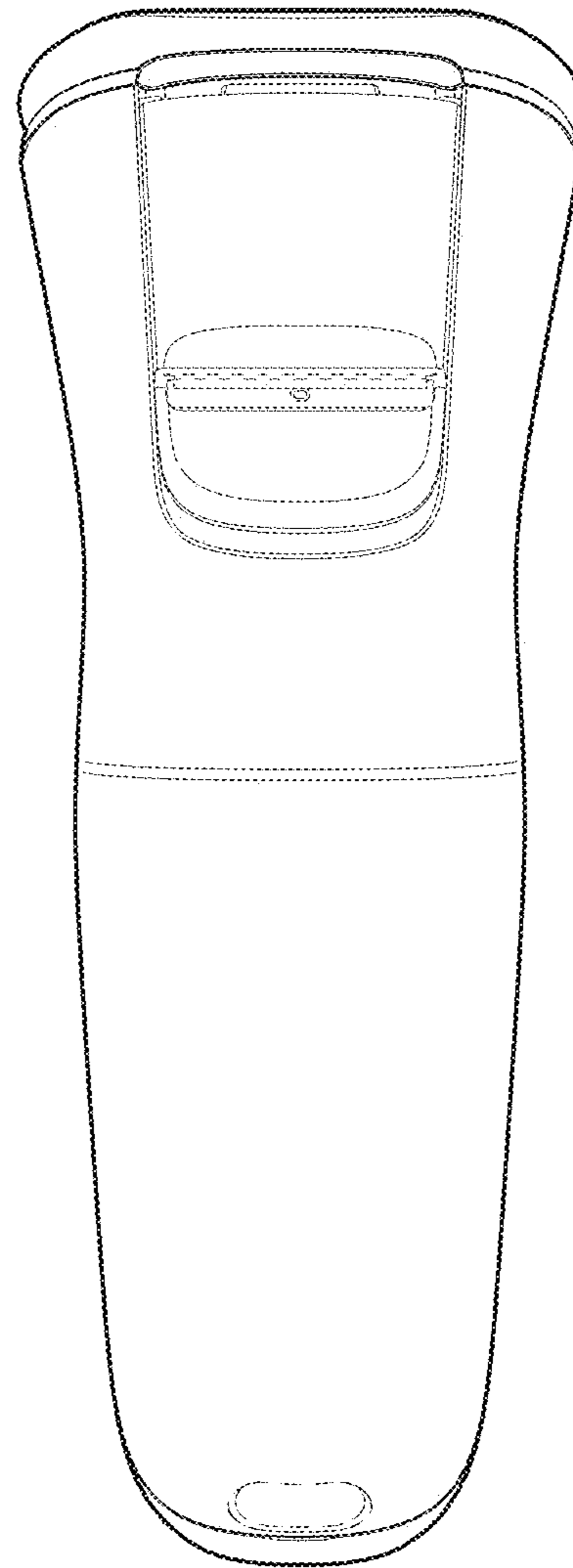

FIG. 10



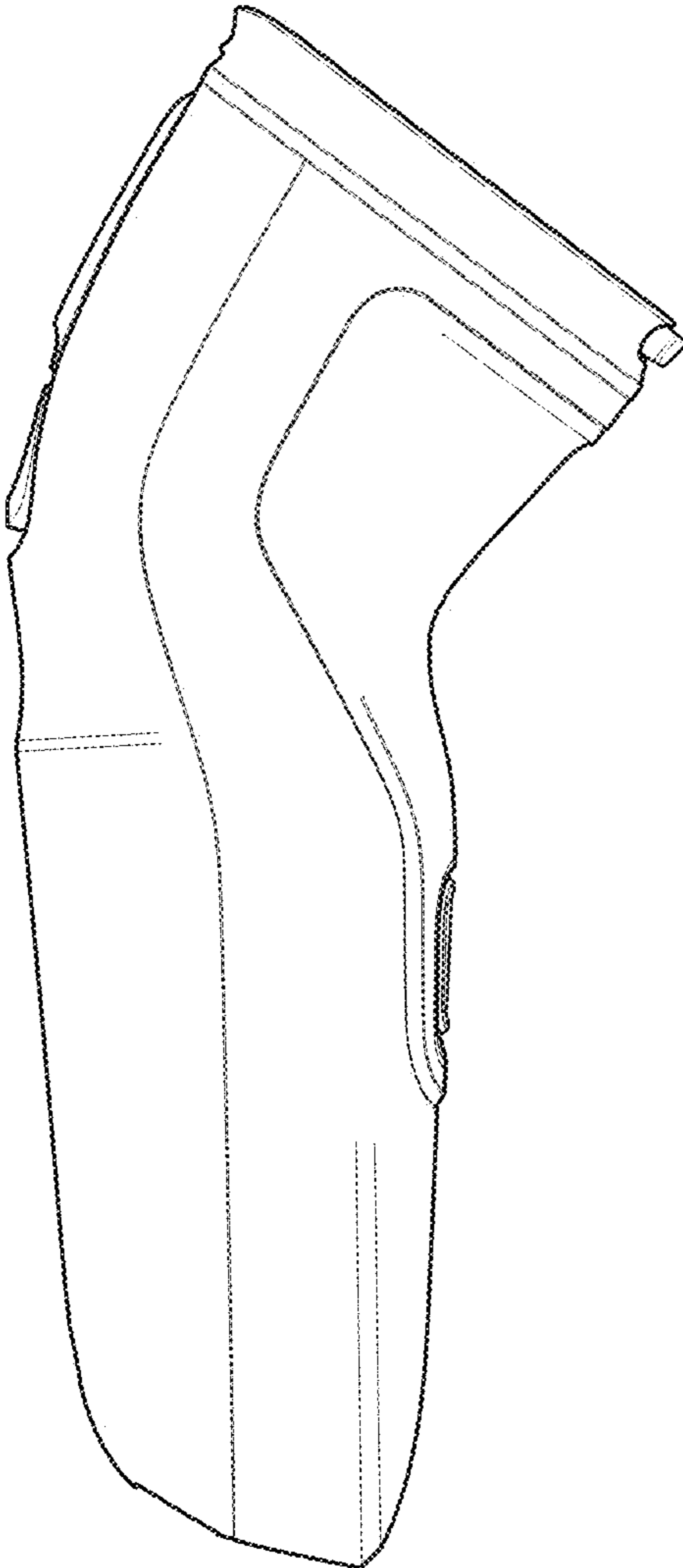

FIG. 11

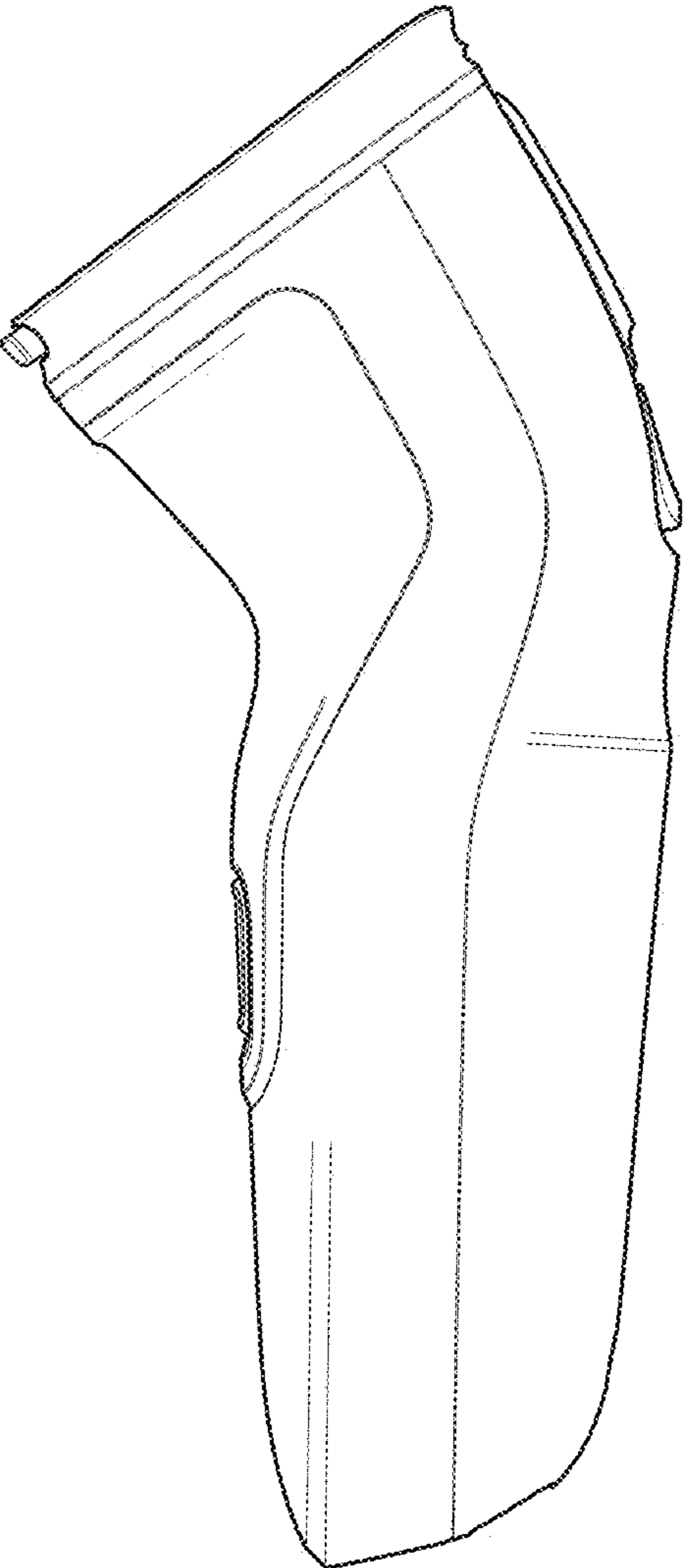

FIG. 12

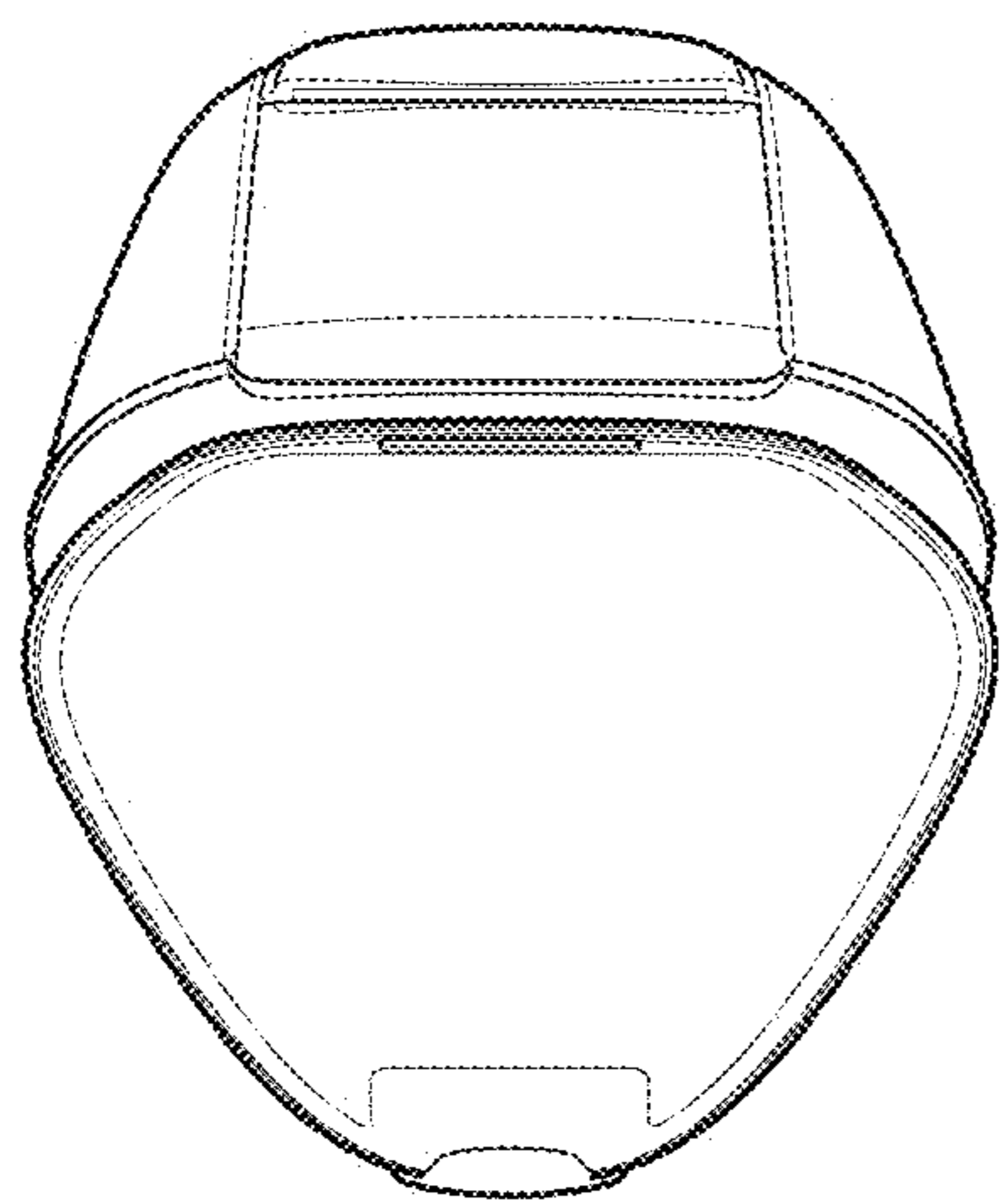

FIG. 13

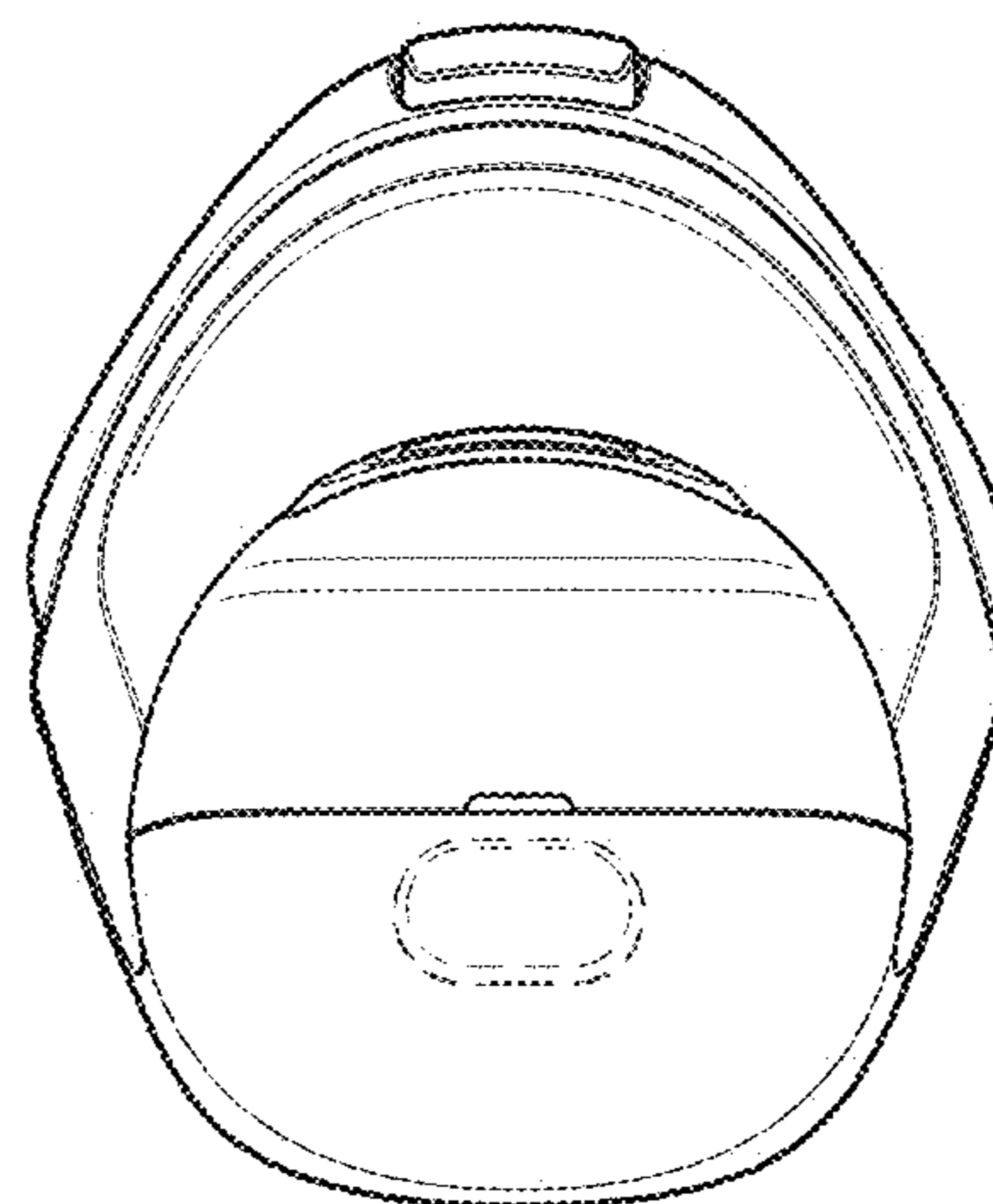

FIG. 14

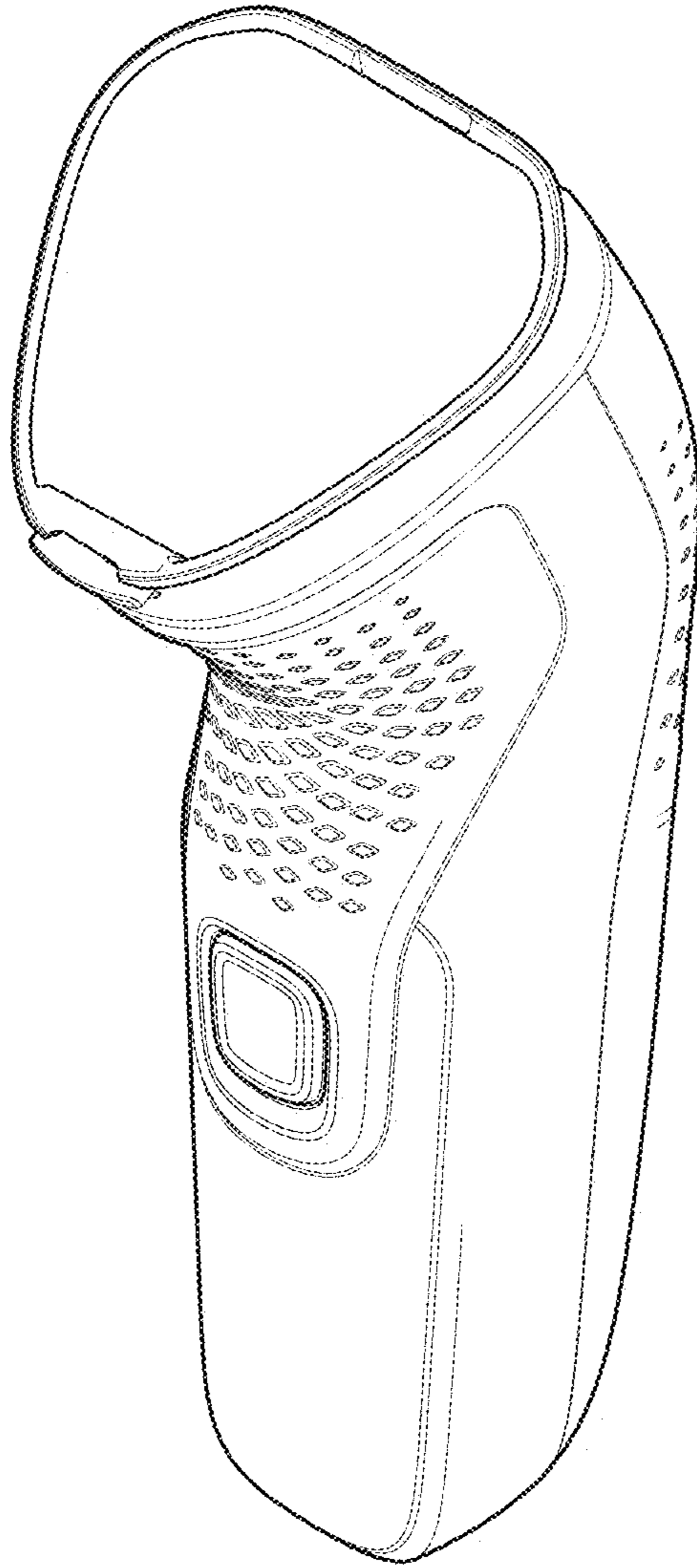

FIG. 15

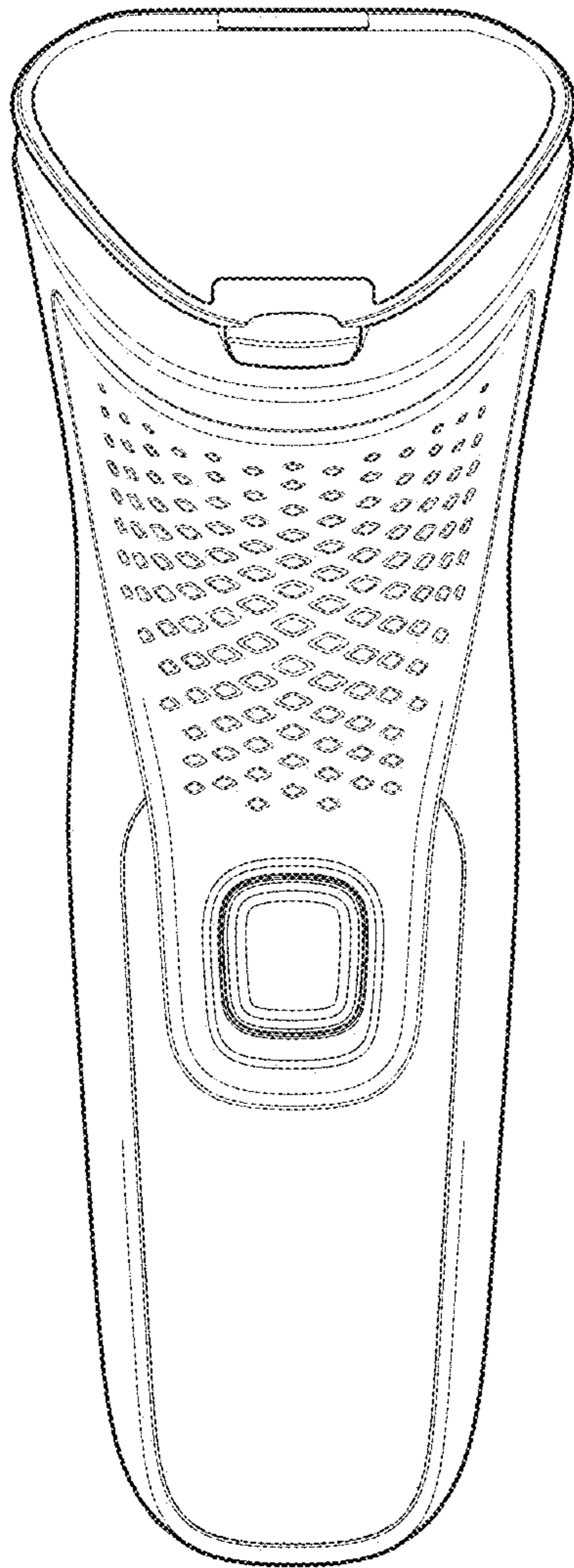

FIG. 16

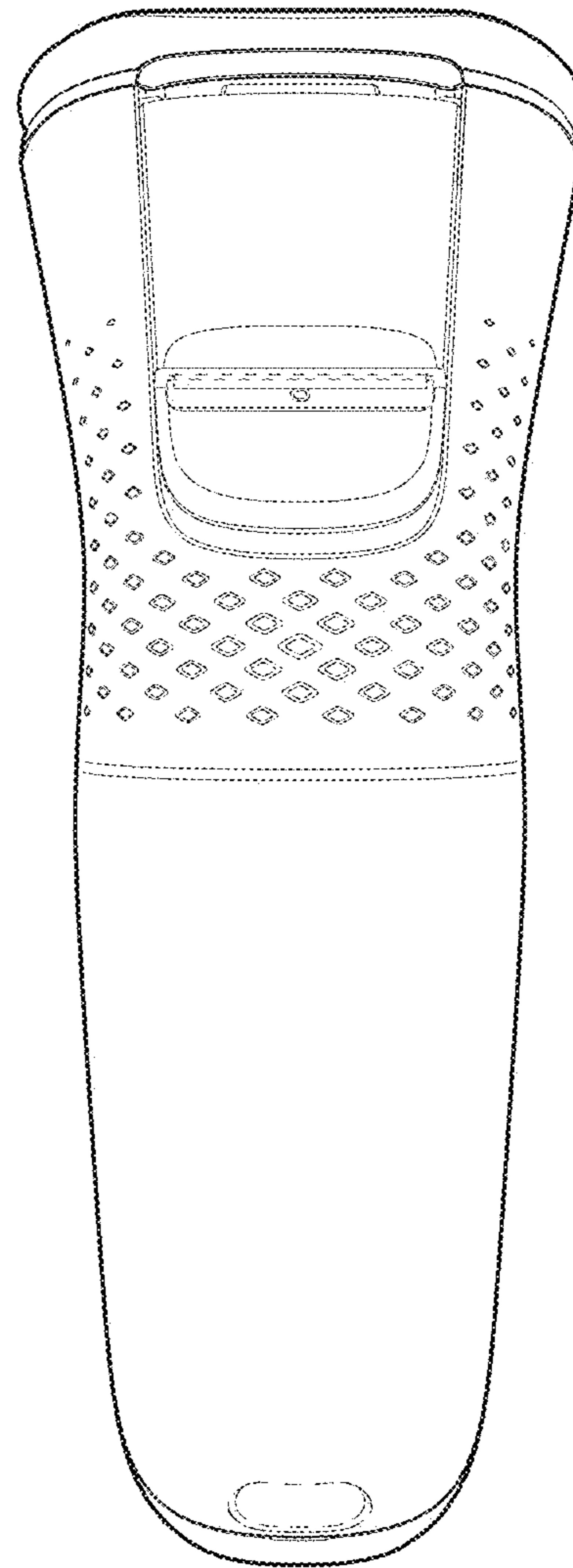

FIG. 17

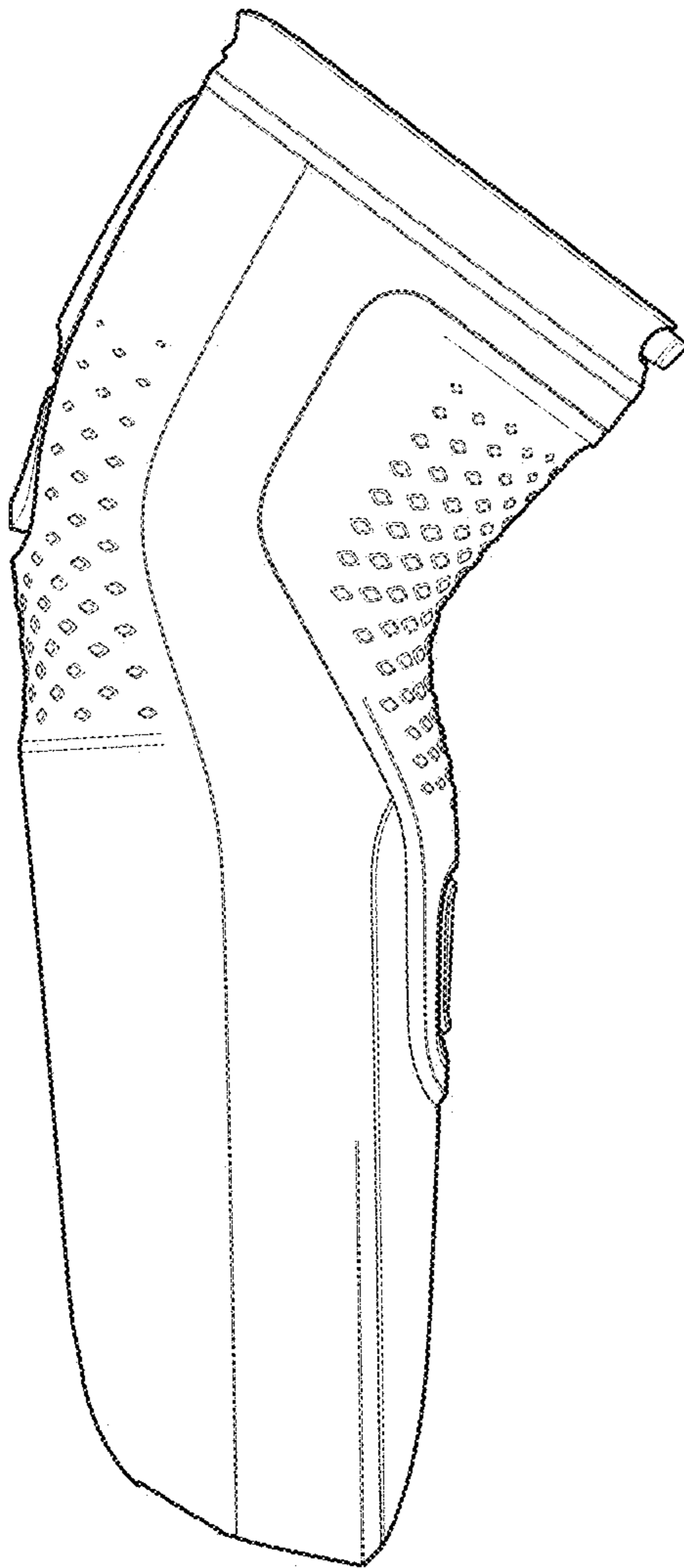

FIG. 18

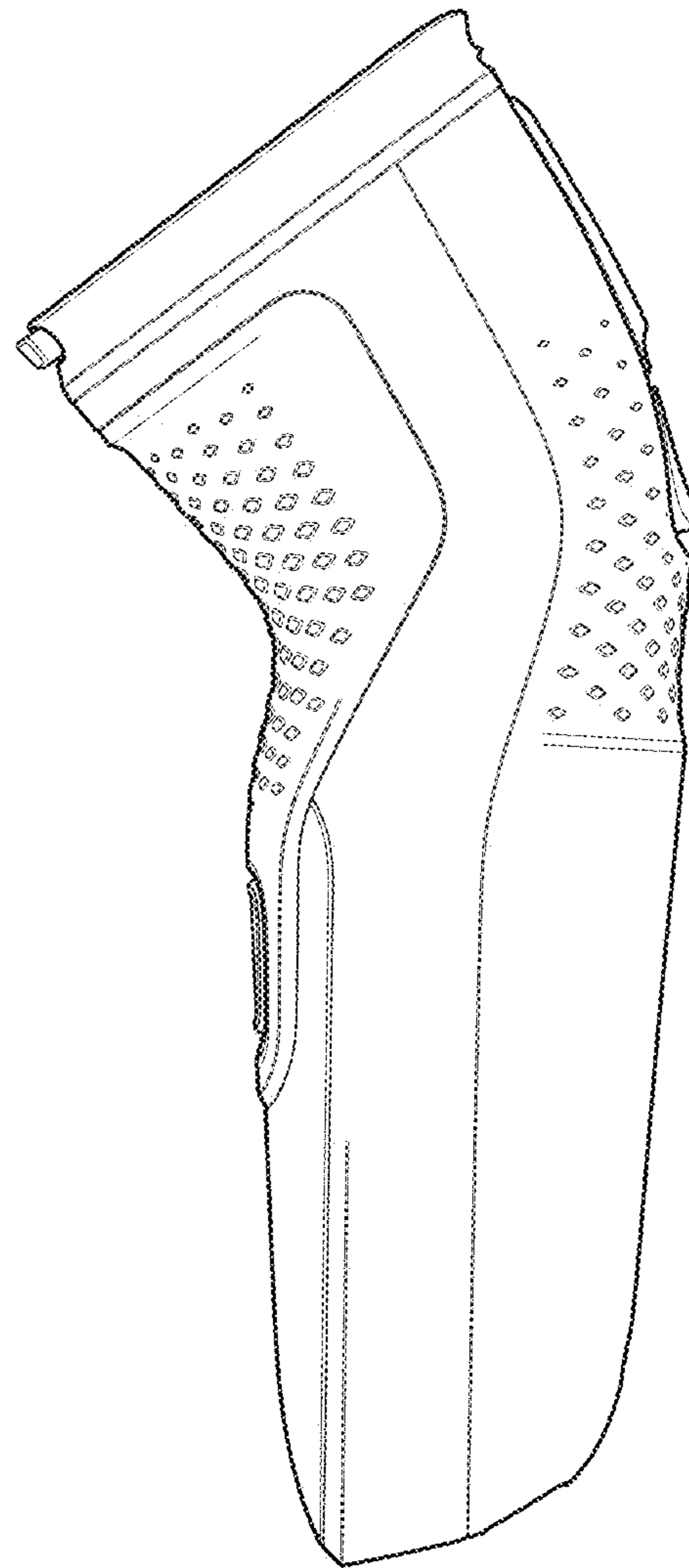

FIG. 19

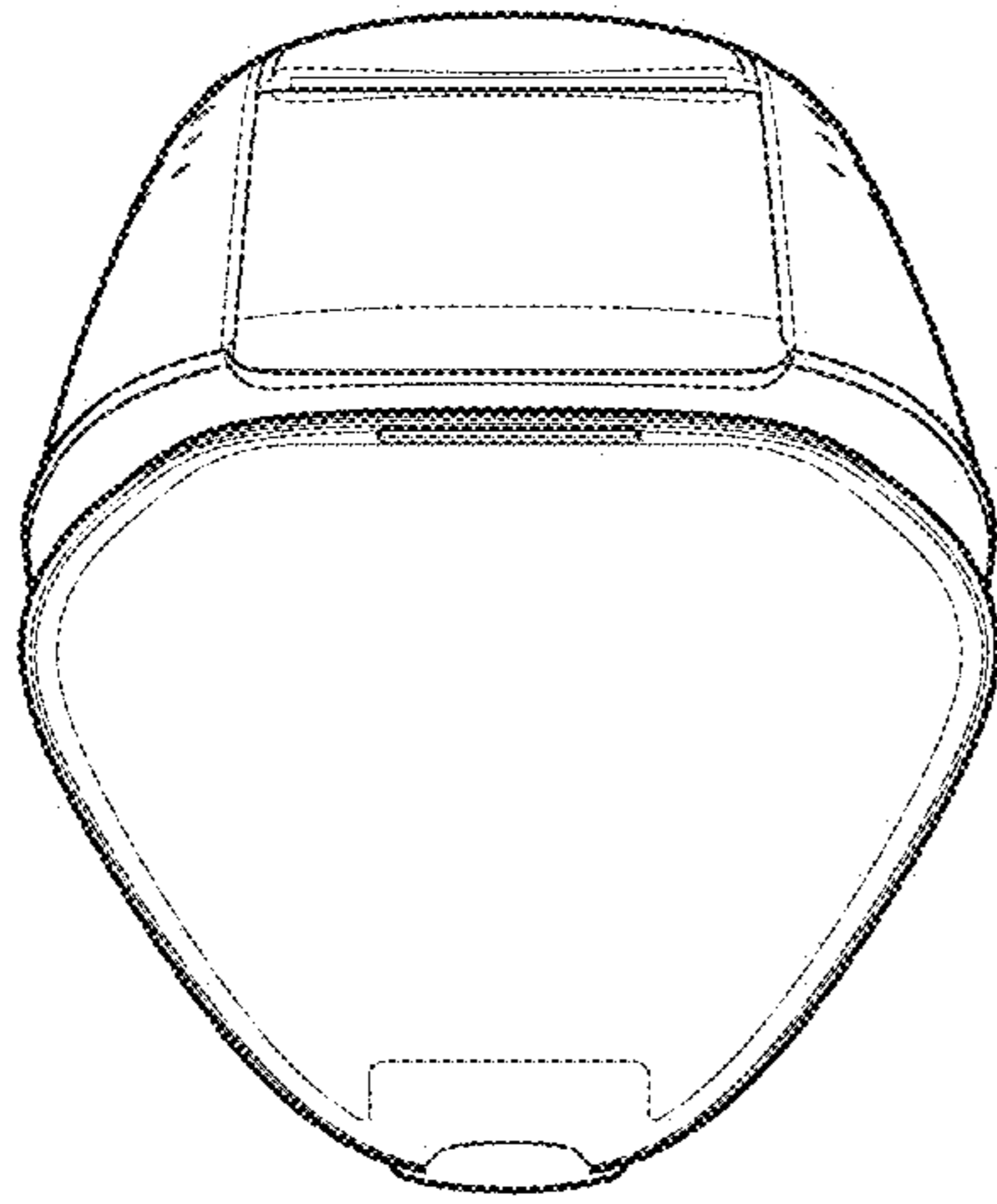

FIG. 20

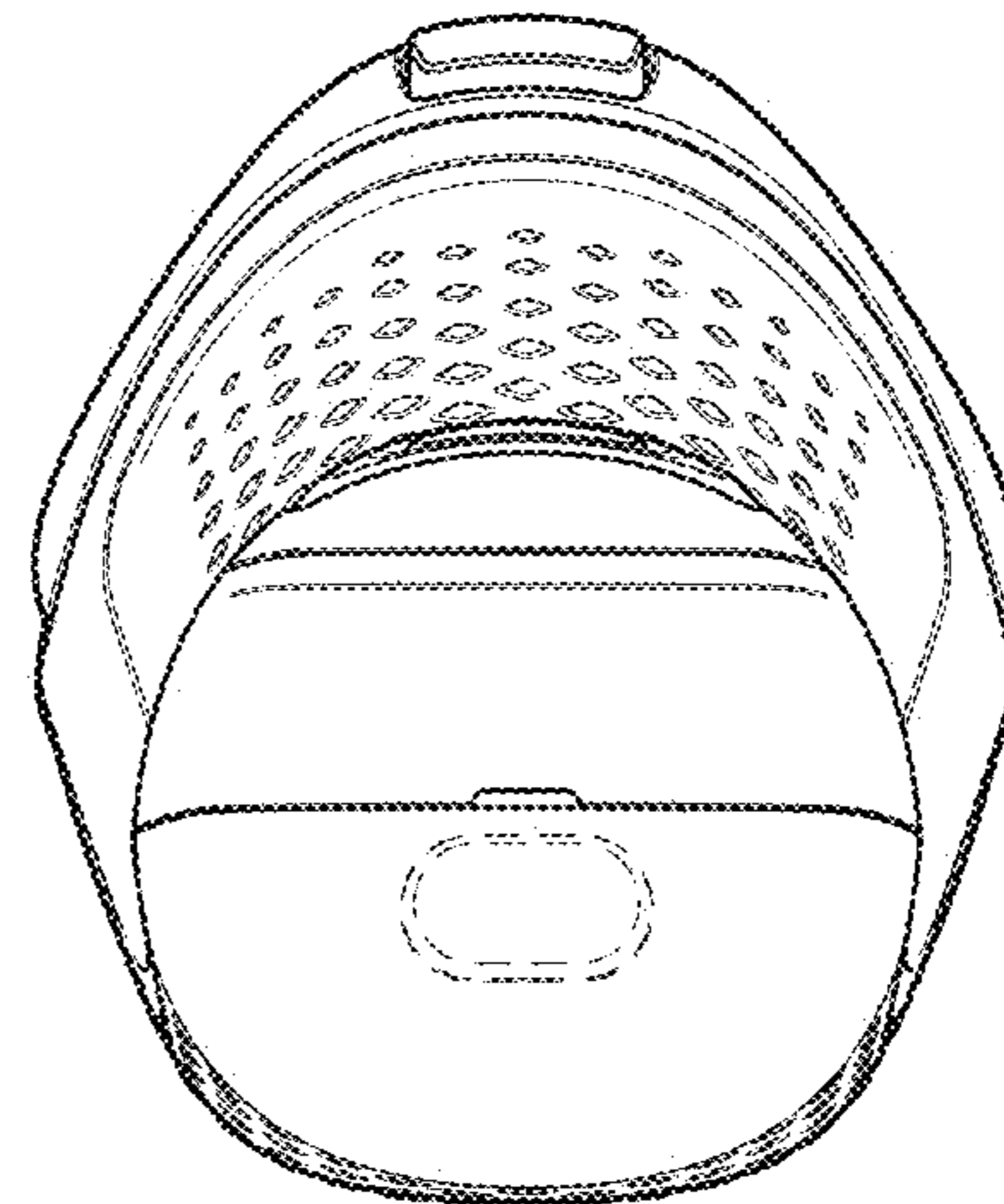

FIG. 21

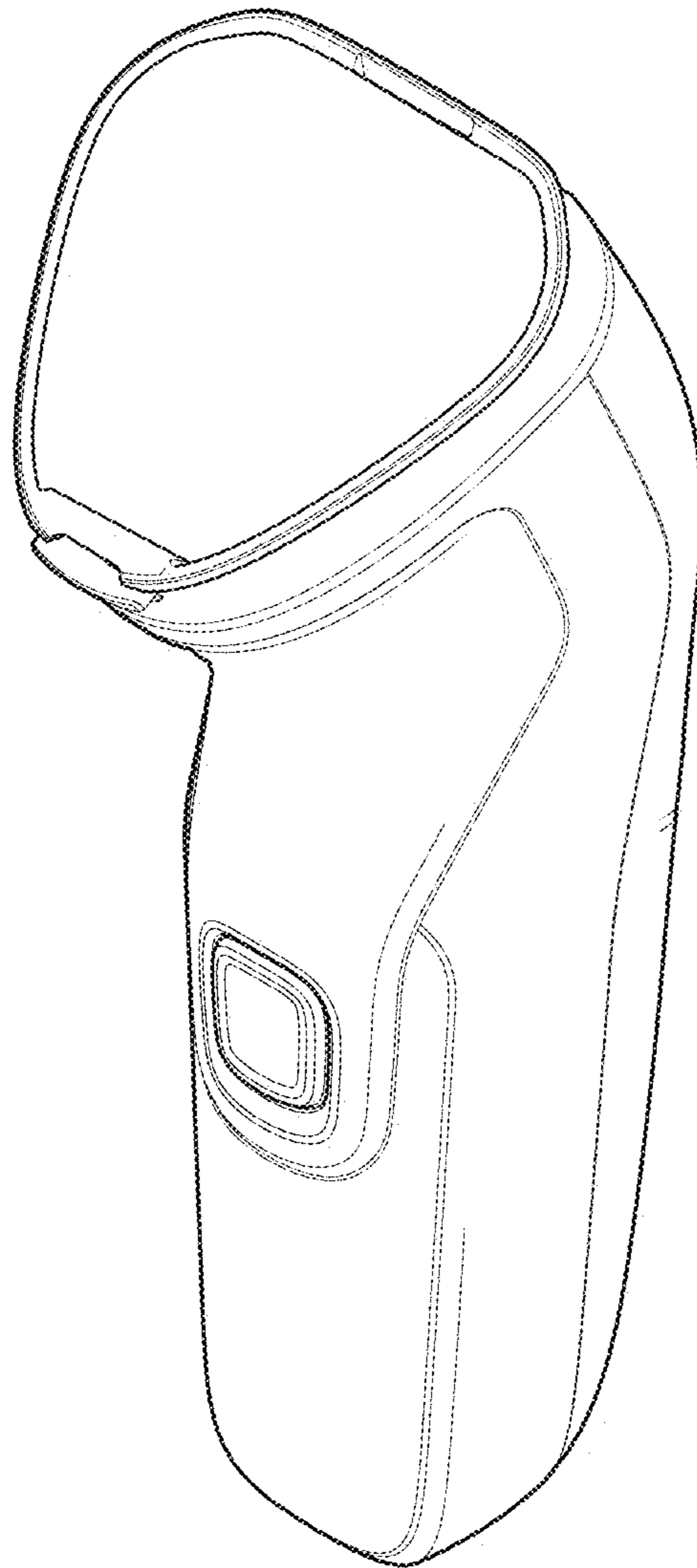

FIG. 22

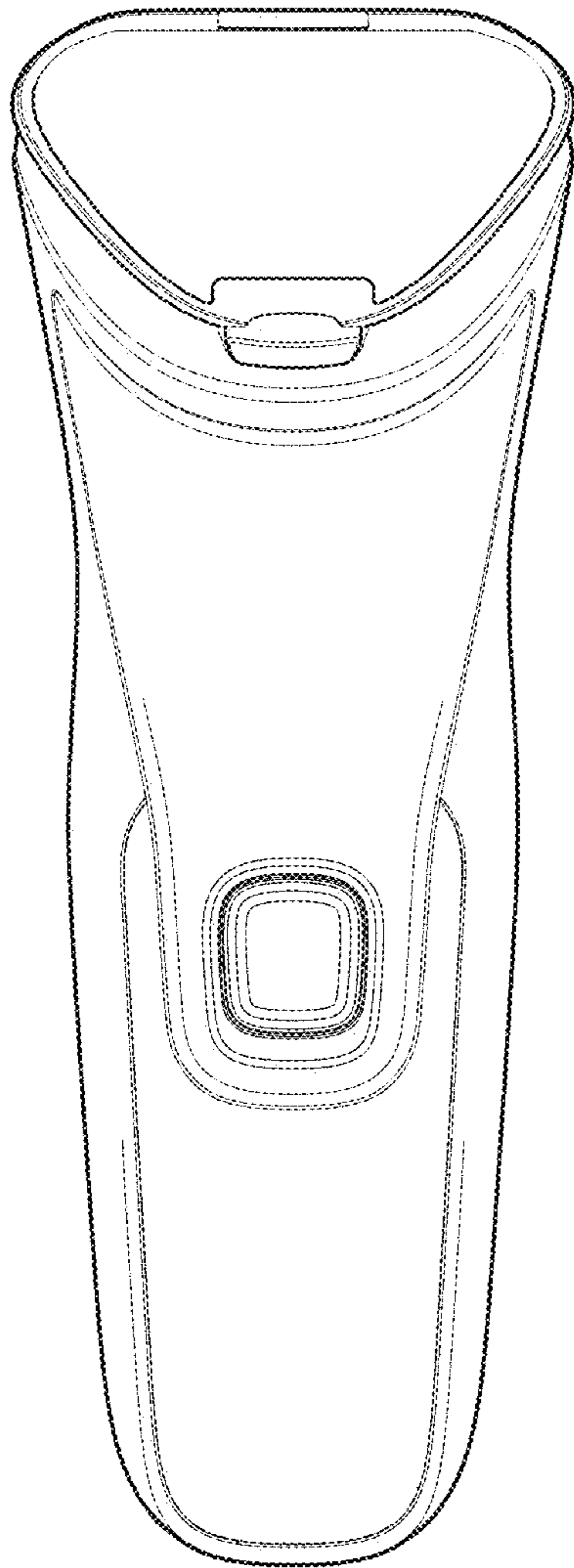

FIG. 23

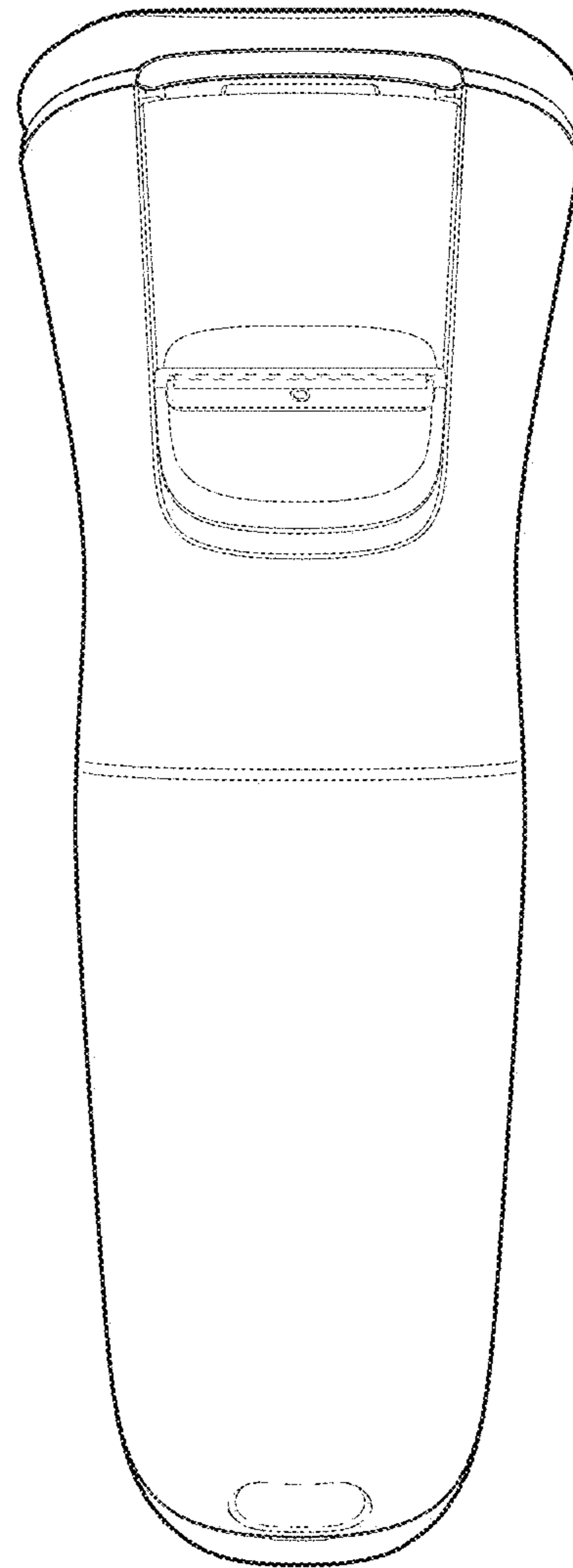

FIG. 24



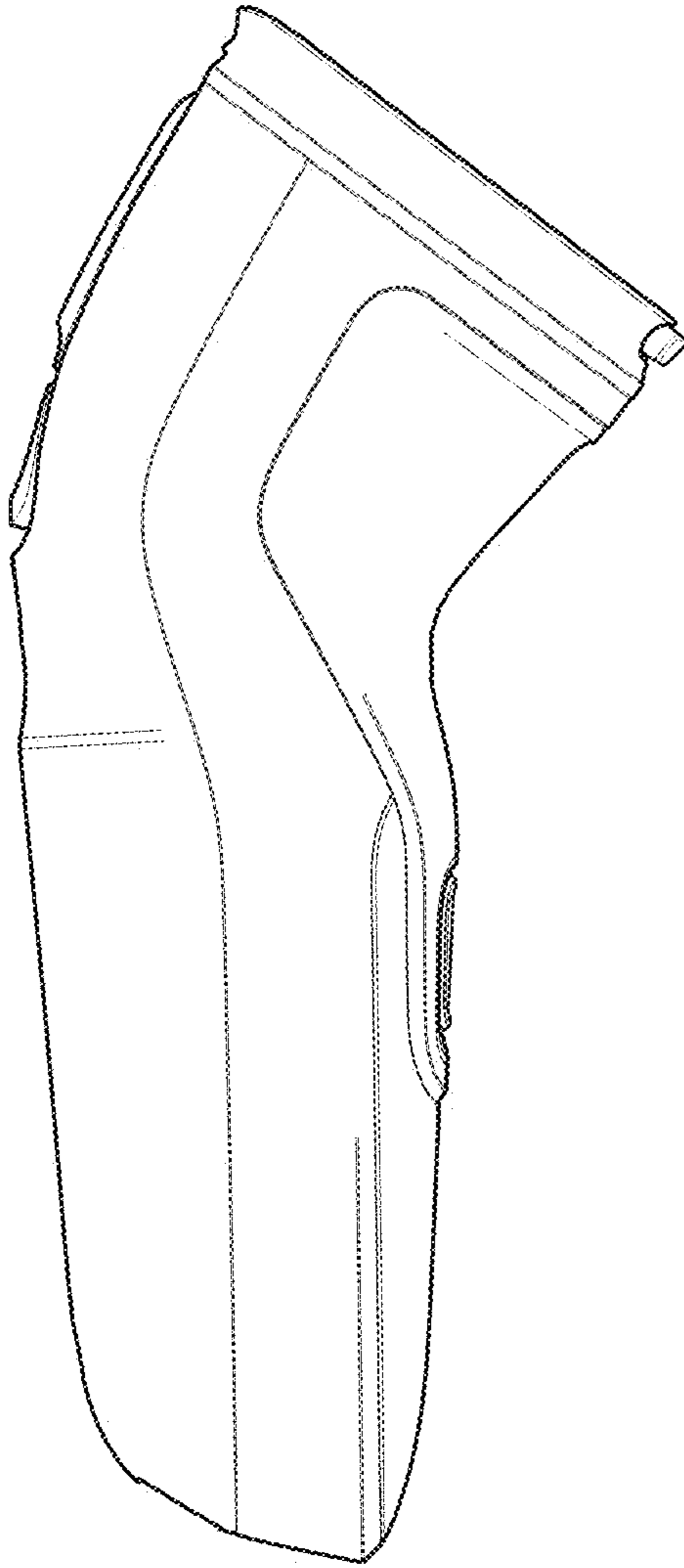

FIG. 25

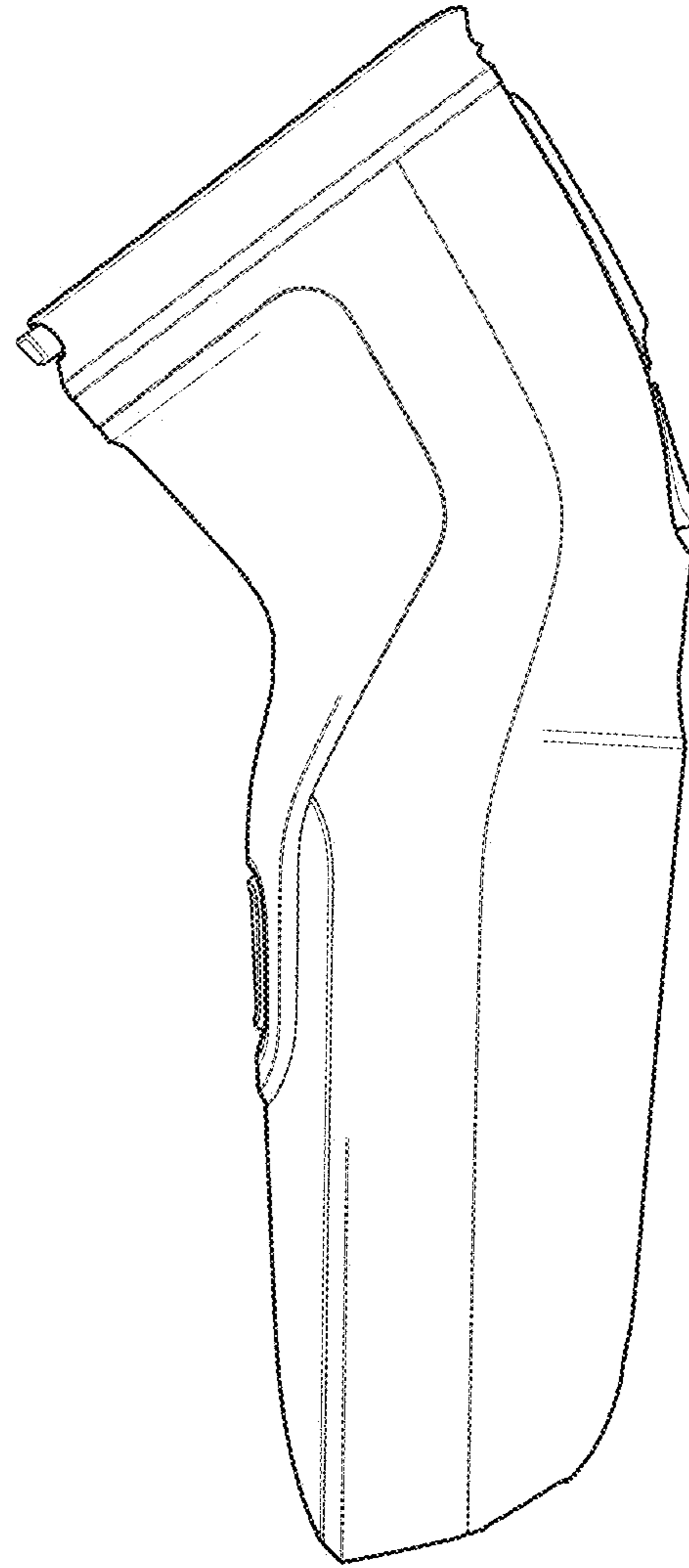

FIG. 26

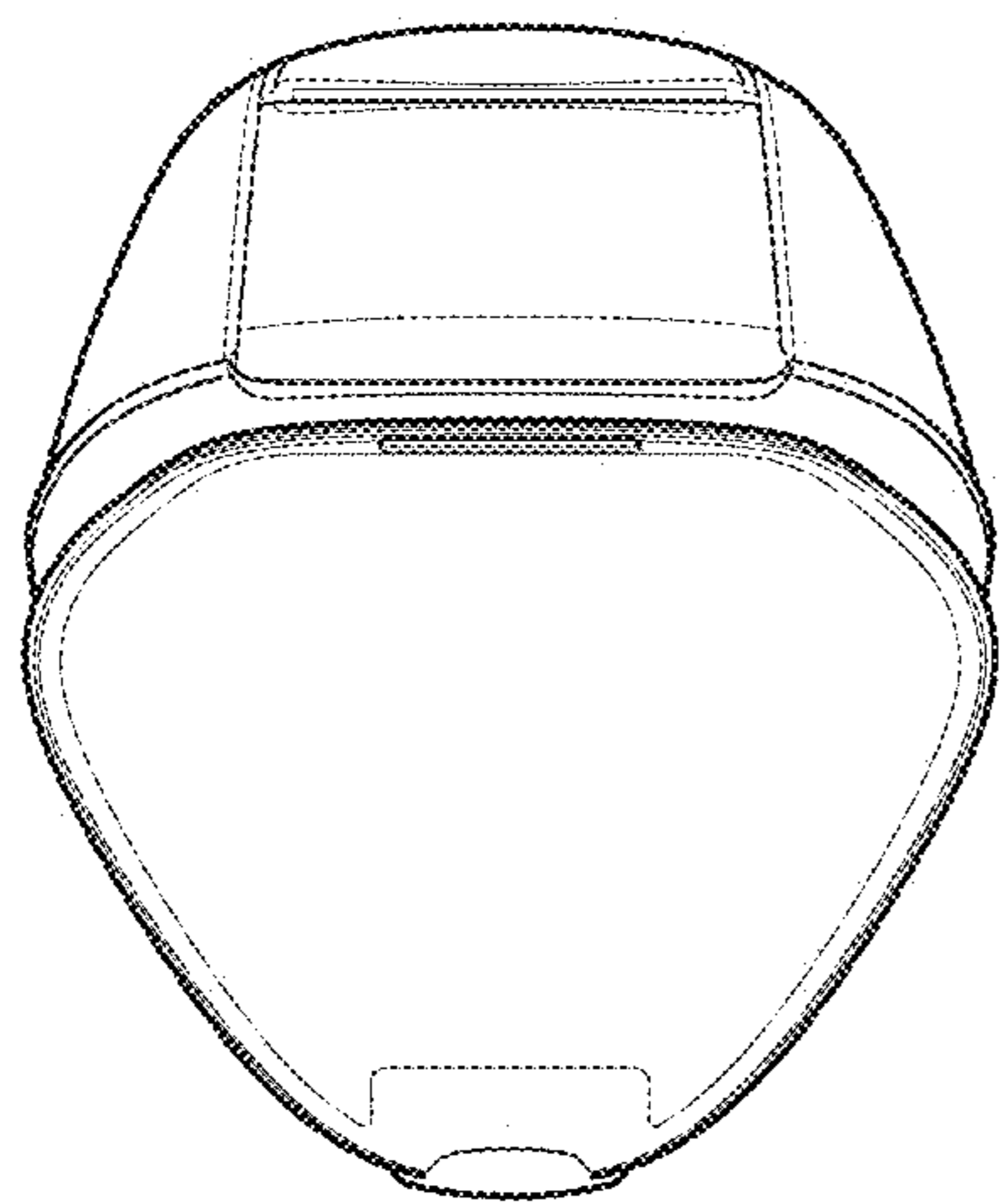

FIG. 27

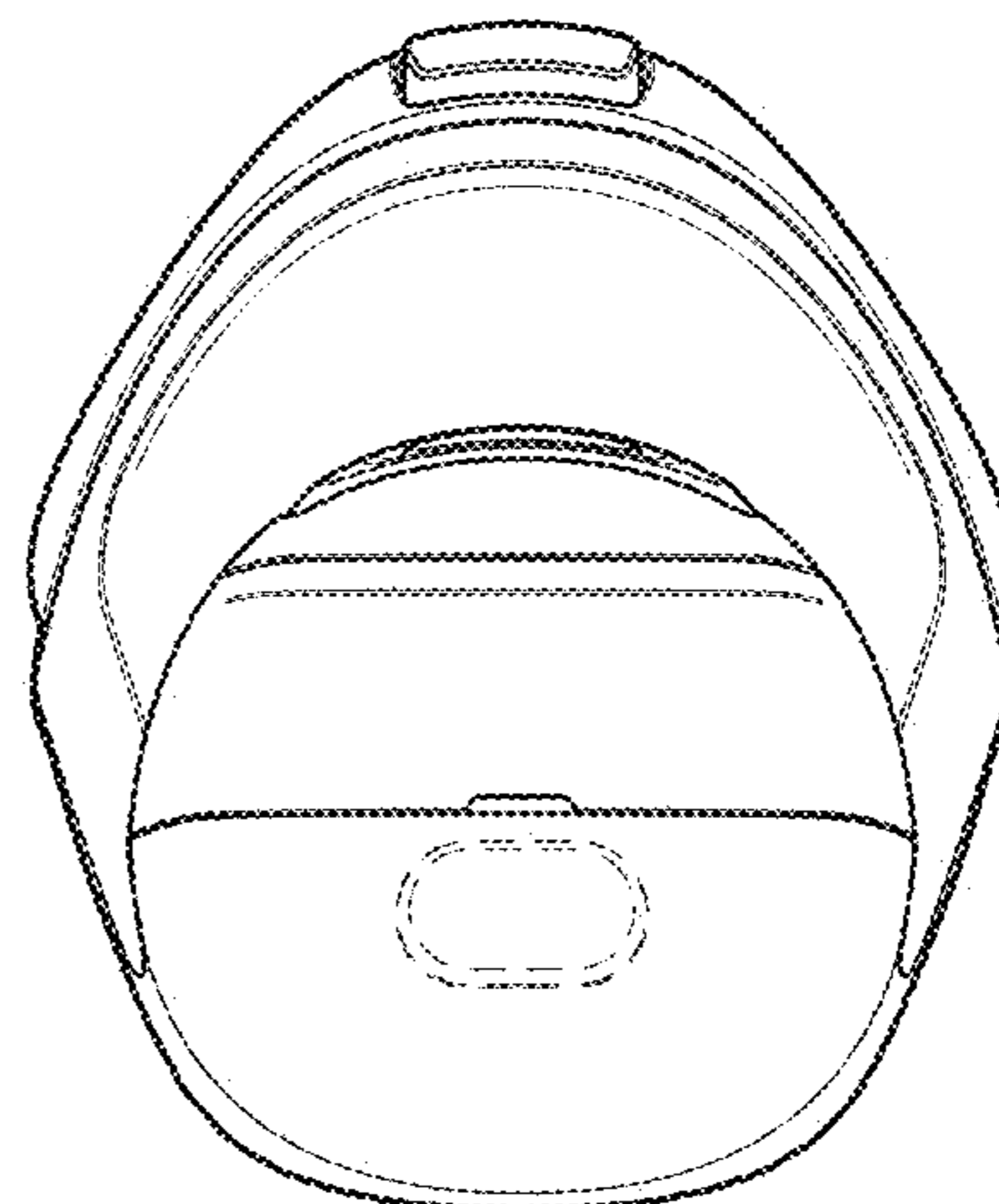

FIG. 28