



US00D955044S

(12) **United States Design Patent** (10) **Patent No.:** **US D955,044 S**
Parambathkandi Abdulhakkim et al. (45) **Date of Patent:** **** Jun. 14, 2022**

(54) **SHAVER**

Primary Examiner — Jennifer Rivard

(71) Applicant: **KONINKLIJKE PHILIPS N.V.**,
Eindhoven (NL)

(57) **CLAIM**

The ornamental design for a shaver, as shown and described.

(72) Inventors: **Roshan Ali Hakkim Parambathkandi Abdulhakkim**, Utrecht (NL); **Roeland Gerard Krooshof**, Bilthoven (NL)

DESCRIPTION

(73) Assignee: **KONINKLIJKE PHILIPS N.V.**,
Eindhoven (NL)

FIG. 1 is a perspective view showing the first embodiment of our design;

FIG. 2 is a front elevational view thereof;

FIG. 3 is a rear elevational view thereof;

FIG. 4 is a right side elevational view thereof;

FIG. 5 is a left side elevational view thereof;

FIG. 6 is a top plan view thereof;

FIG. 7 is a bottom plan view thereof;

FIG. 8 is a perspective view showing the second embodiment of our design;

FIG. 9 is a front elevational view thereof;

FIG. 10 is a rear elevational view thereof;

FIG. 11 is a right side elevational view thereof;

FIG. 12 is a left side elevational view thereof;

FIG. 13 is a top plan view thereof;

FIG. 14 is a bottom plan view thereof;

FIG. 15 is a perspective view showing the third embodiment of our design;

FIG. 16 is a front elevational view thereof;

FIG. 17 is a rear elevational view thereof;

FIG. 18 is a right side elevational view thereof;

FIG. 19 is a left side elevational view thereof;

FIG. 20 is a top plan view thereof;

FIG. 21 is a bottom plan view thereof;

FIG. 22 is a perspective view showing the fourth embodiment of our design;

FIG. 23 is a front elevational view thereof;

FIG. 24 is a rear elevational view thereof;

FIG. 25 is a right side elevational view thereof;

FIG. 26 is a left side elevational view thereof;

FIG. 27 is a top plan view thereof; and,

FIG. 28 is a bottom plan view thereof.

The broken lines illustrate a portion of the shaver that forms no part of the claimed design.

(**) Term: **15 Years**

(21) Appl. No.: **29/706,297**

(22) Filed: **Sep. 19, 2019**

(30) **Foreign Application Priority Data**

Mar. 21, 2019 (EM) 006317418-0001

(51) **LOC (13) Cl.** **28-03**

(52) **U.S. Cl.**
USPC **D28/50**

(58) **Field of Classification Search**
USPC D28/49-54
CPC B26B 19/14-18; B26B 19/38; B26B
19/3853-3893; B26B 19/3806-384
See application file for complete search history.

(56) **References Cited**

U.S. PATENT DOCUMENTS

D367,944 S * 3/1996 Izumi D28/50
D383,566 S * 9/1997 Bone D28/50
D389,273 S * 1/1998 Bone D28/50
D389,276 S * 1/1998 Bone D28/50
D405,922 S * 2/1999 Bone D28/50
D698,491 S * 1/2014 Ellison D28/50
D748,857 S * 2/2016 Boulanger D28/50

(Continued)

1 Claim, 24 Drawing Sheets

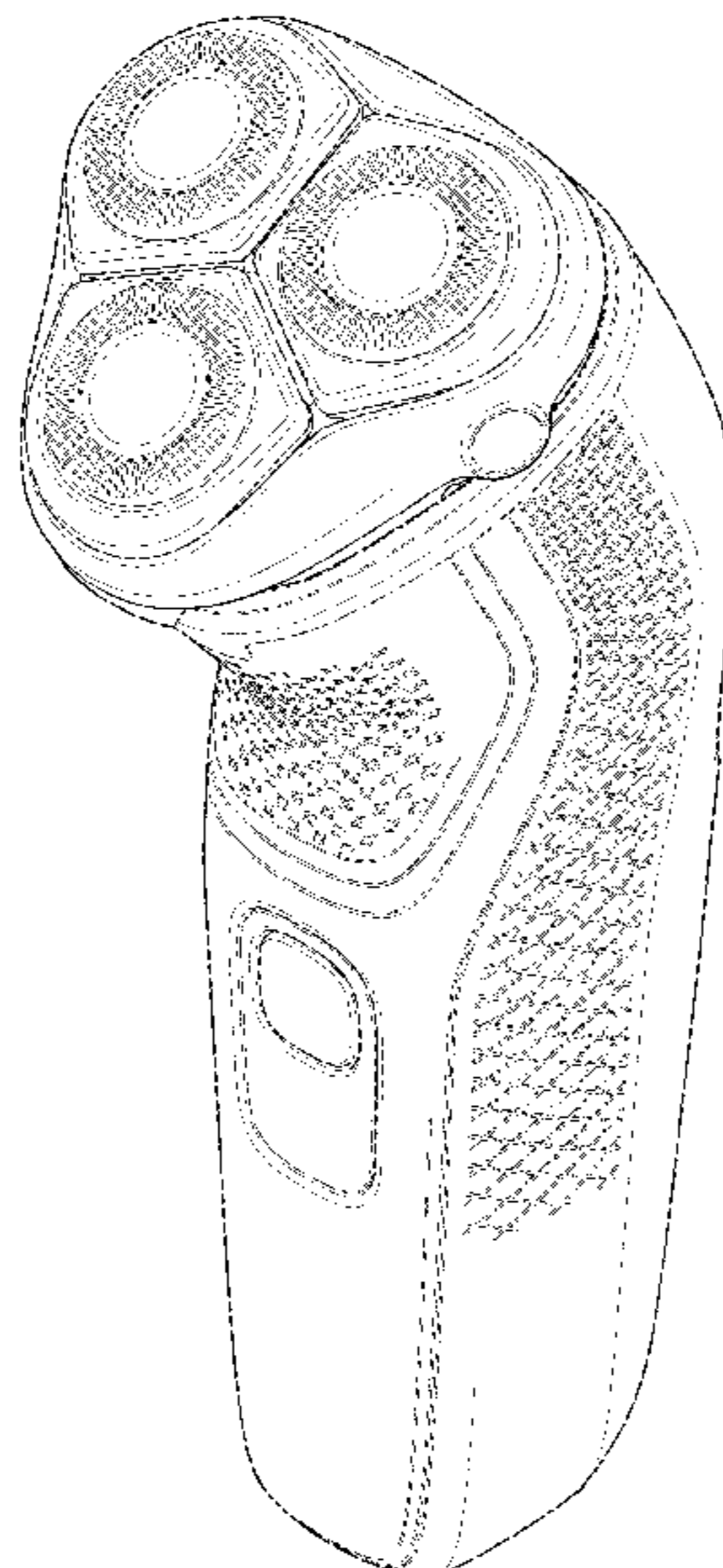

(56)

References Cited

U.S. PATENT DOCUMENTS

D758,015 S *	5/2016	Prat-Pfister	D28/50
D758,017 S *	5/2016	Smith	D28/54
D758,659 S *	6/2016	Smith	D28/50
D776,348 S *	1/2017	Frankel	D28/50
D812,301 S *	3/2018	Yan	D28/50
D819,274 S *	5/2018	Yan	D28/50
D823,542 S *	7/2018	Yan	D28/50
D824,103 S *	7/2018	Yan	D28/50
D856,583 S *	8/2019	Chen	D28/50
D880,064 S *	3/2020	Andersson	D28/50
D912,902 S *	3/2021	Andersson	D28/50

* cited by examiner

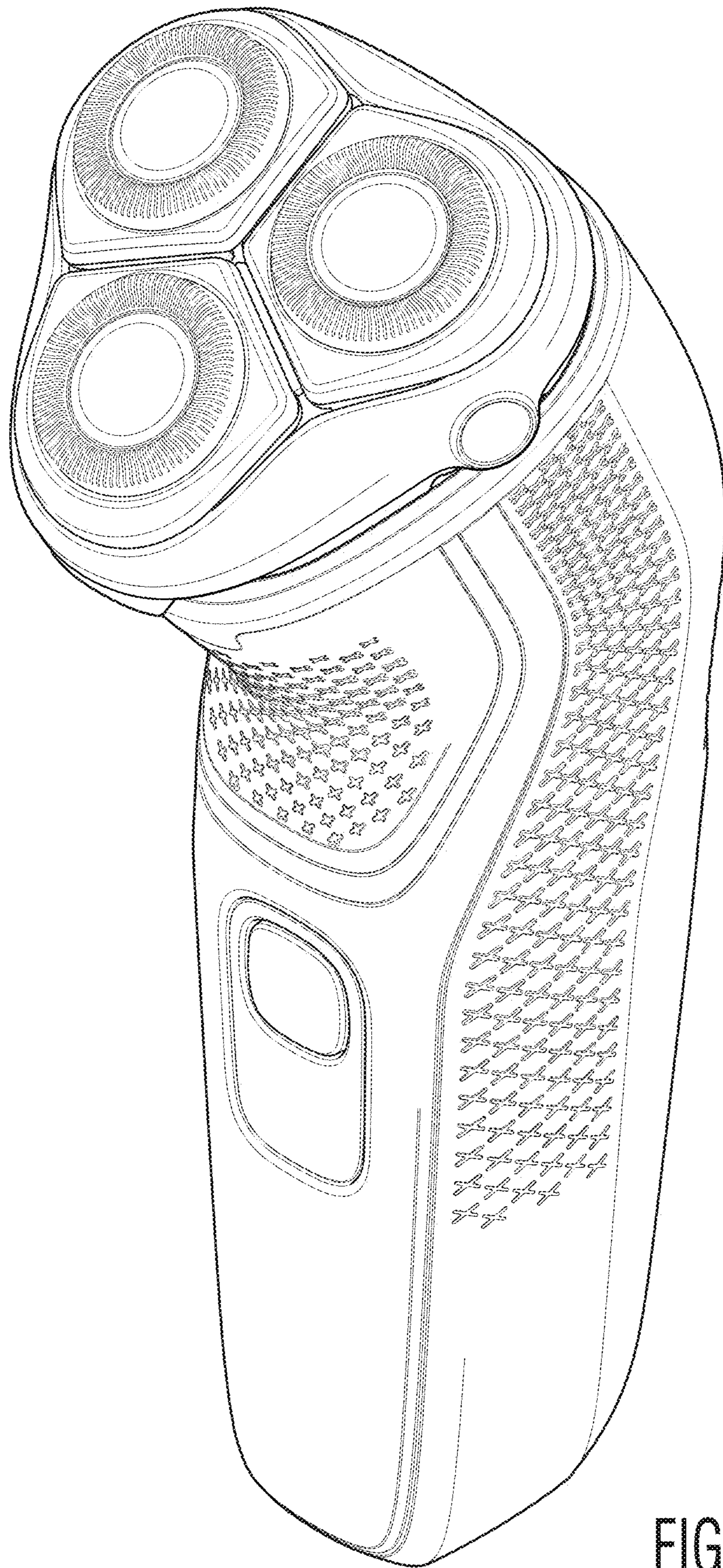

FIG. 1

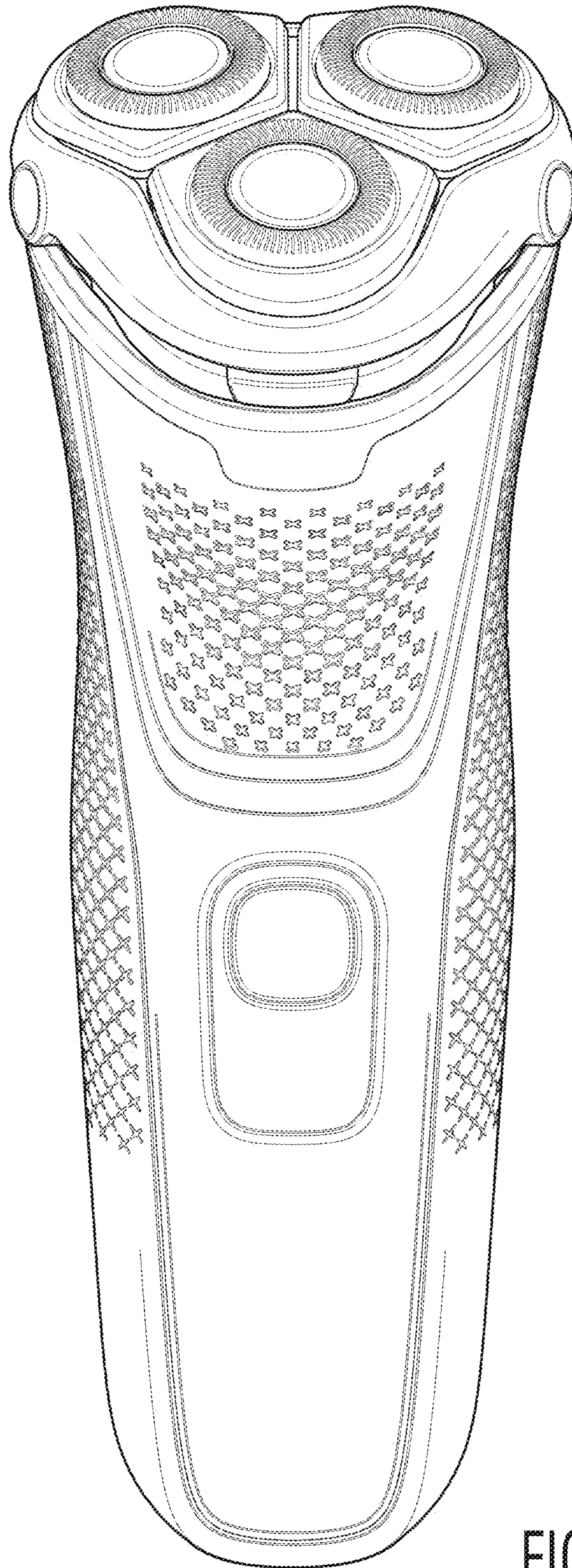

FIG. 2

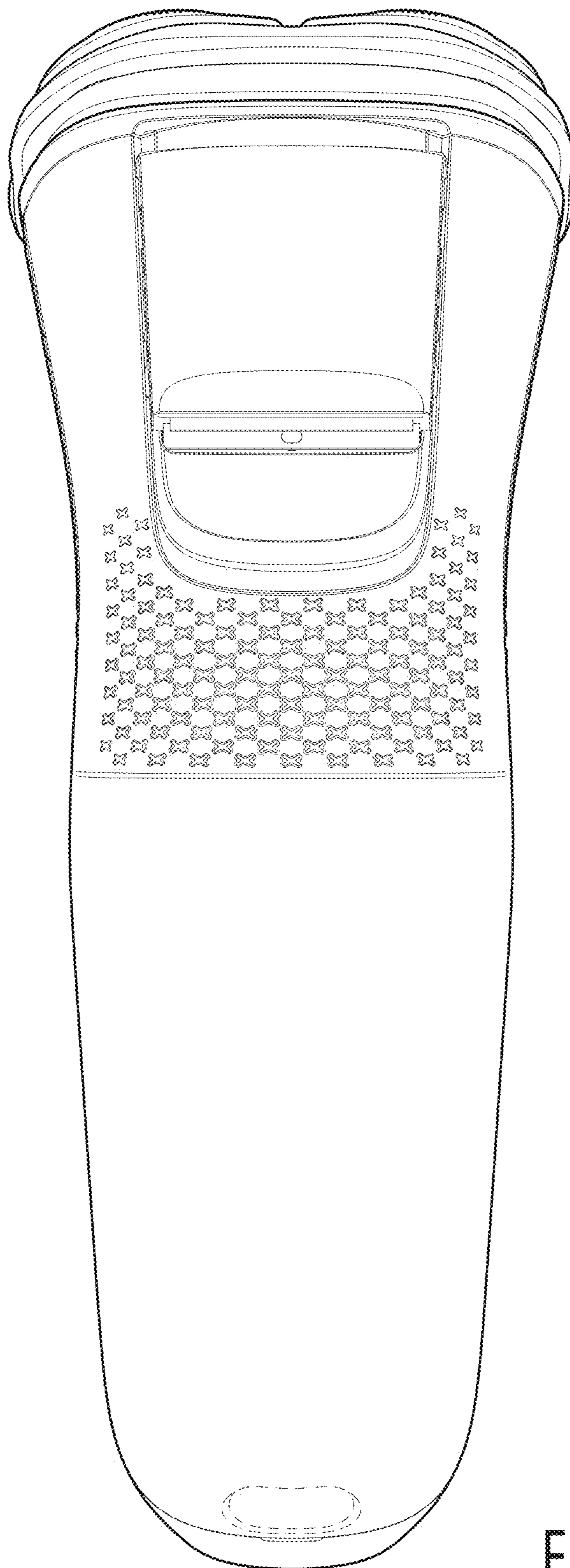

FIG. 3

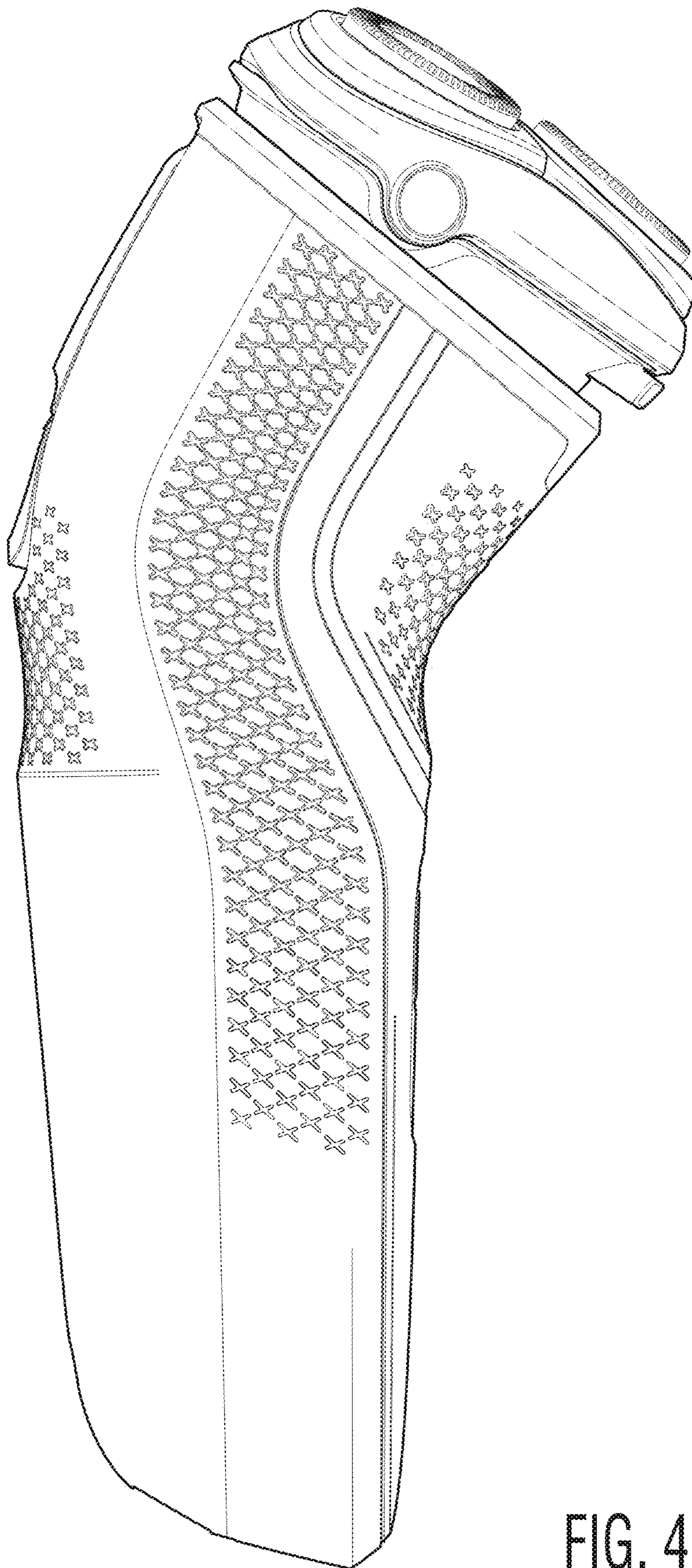

FIG. 4

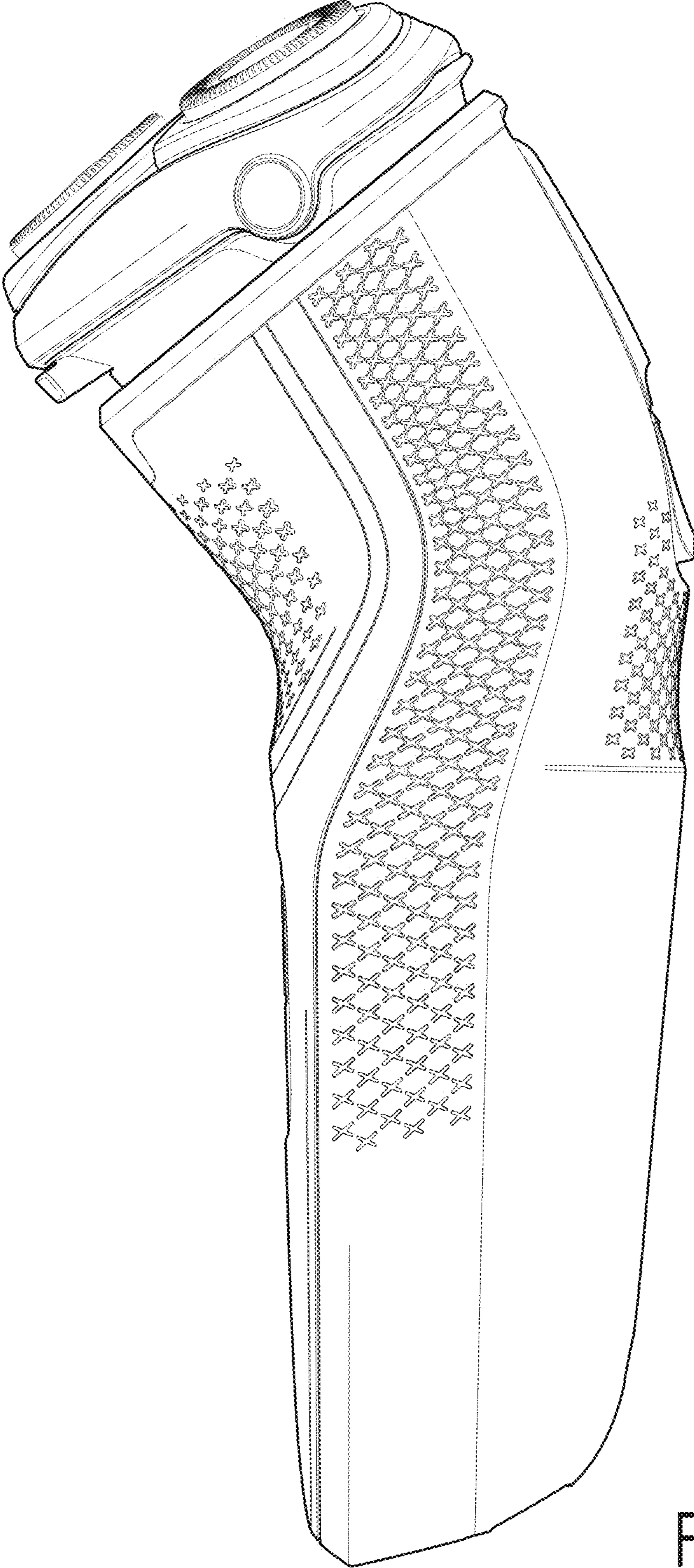

FIG. 5

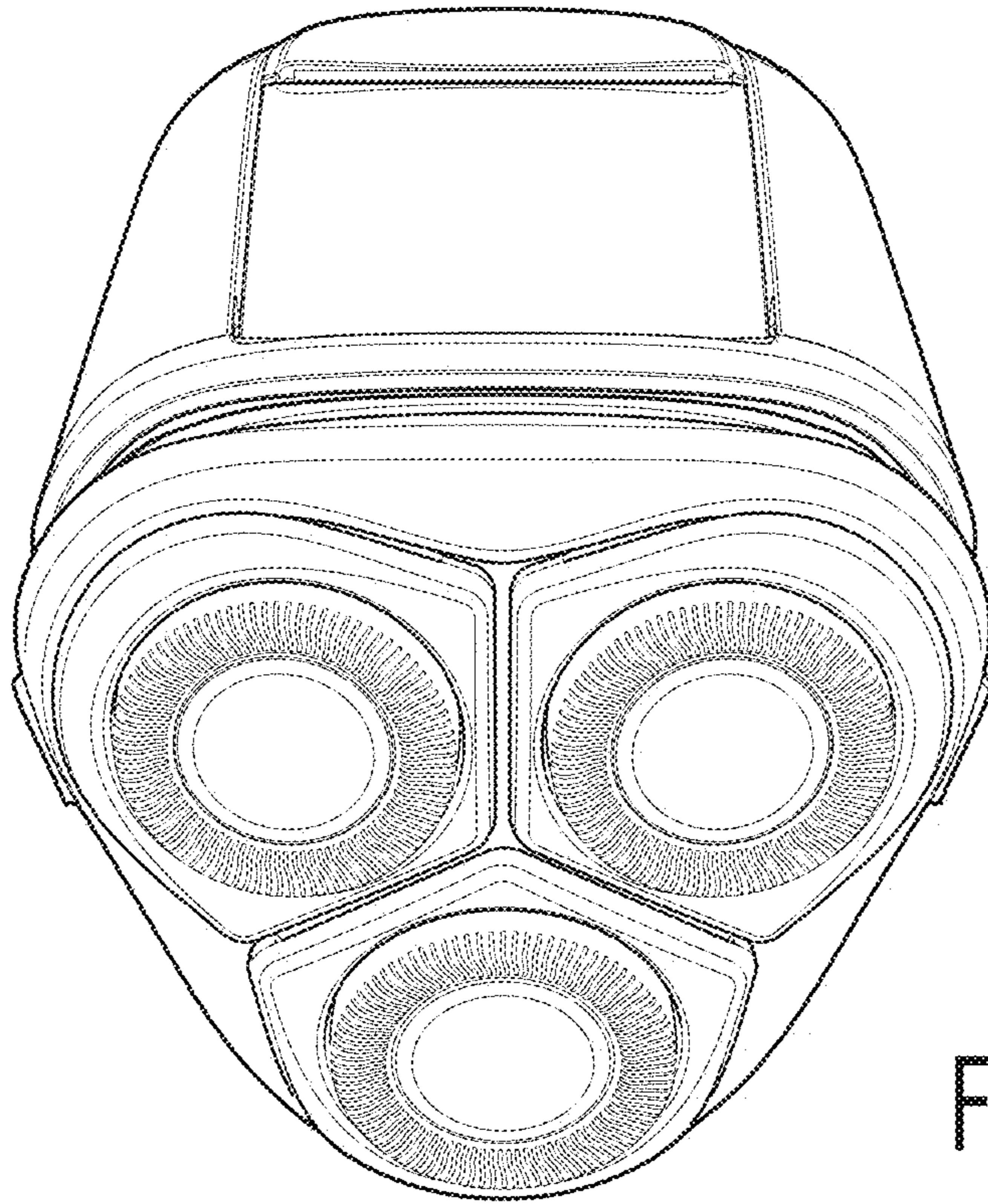

FIG. 6

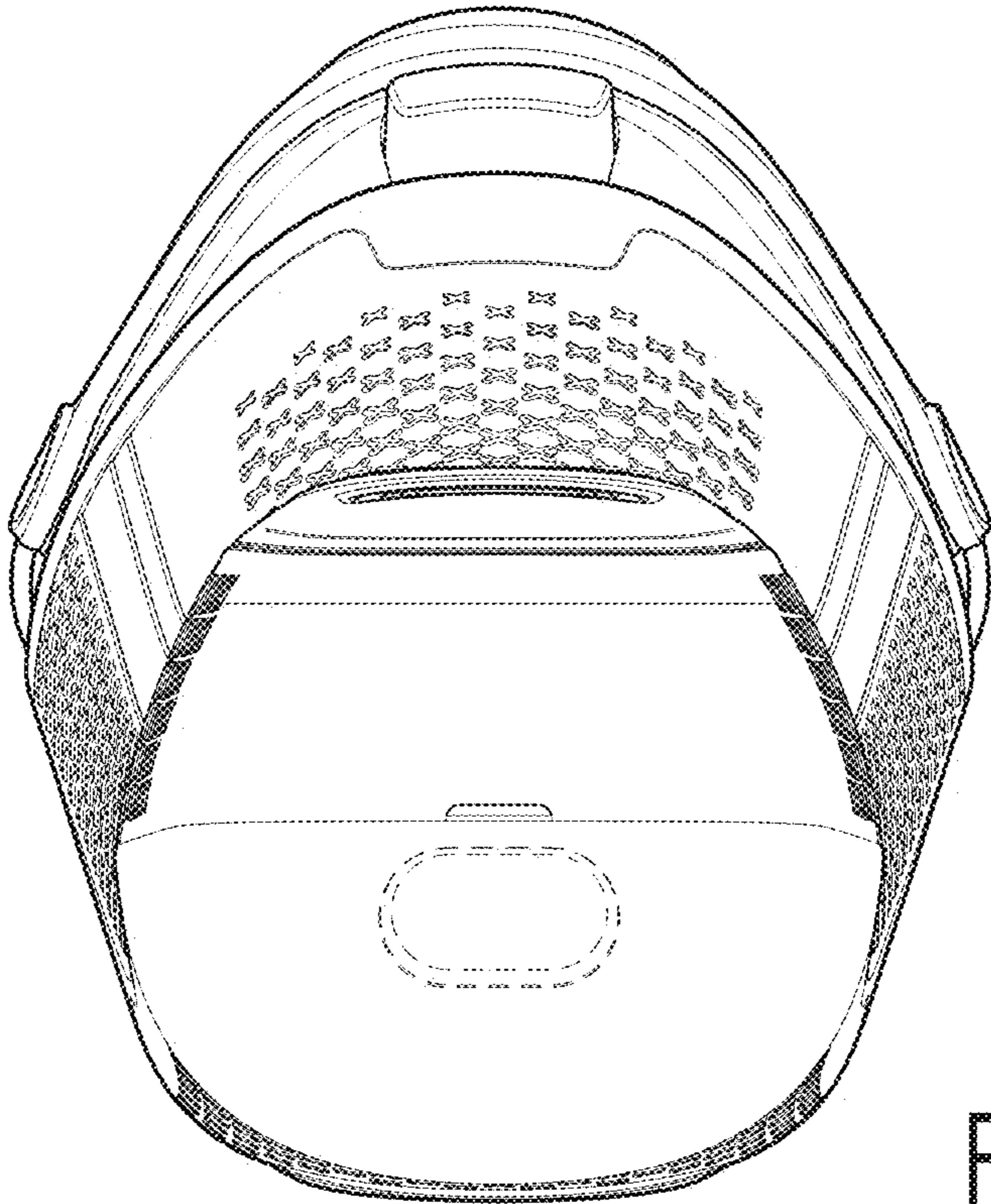

FIG. 7

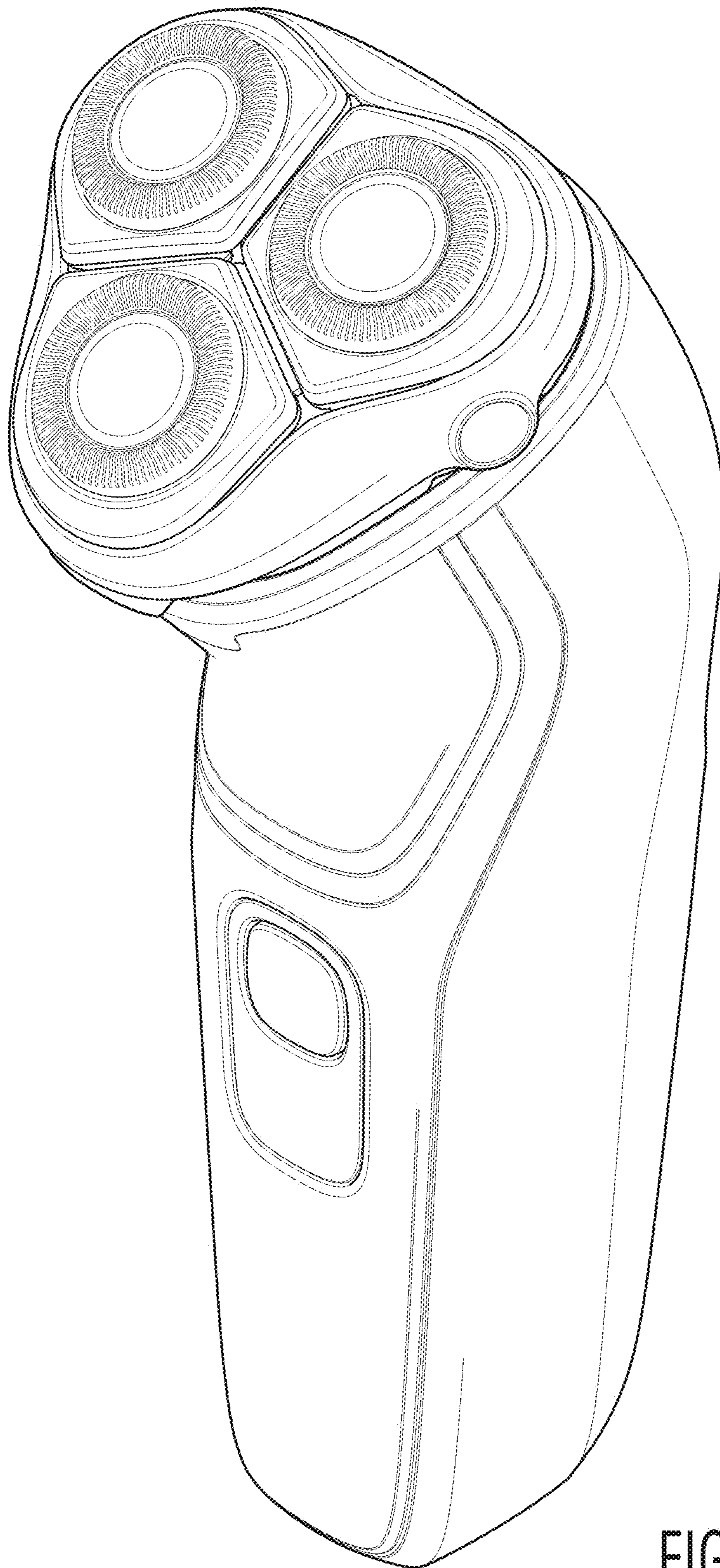

FIG. 8

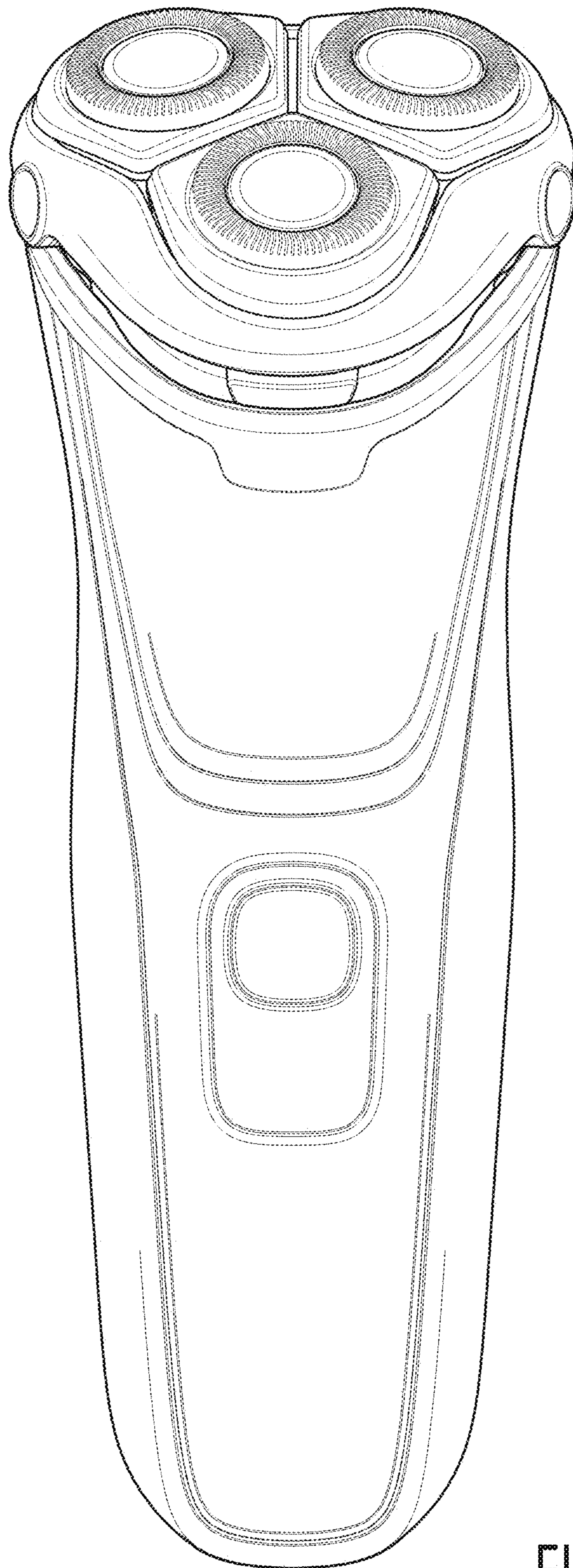

FIG. 9

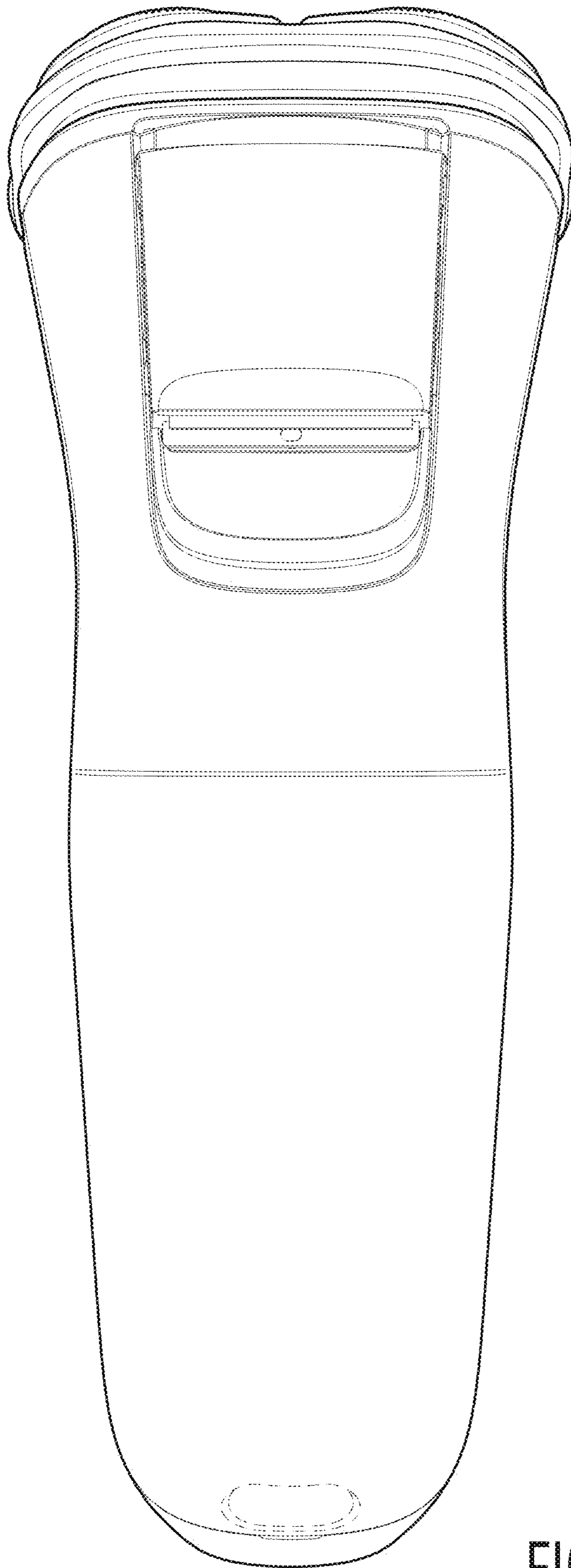

FIG. 10

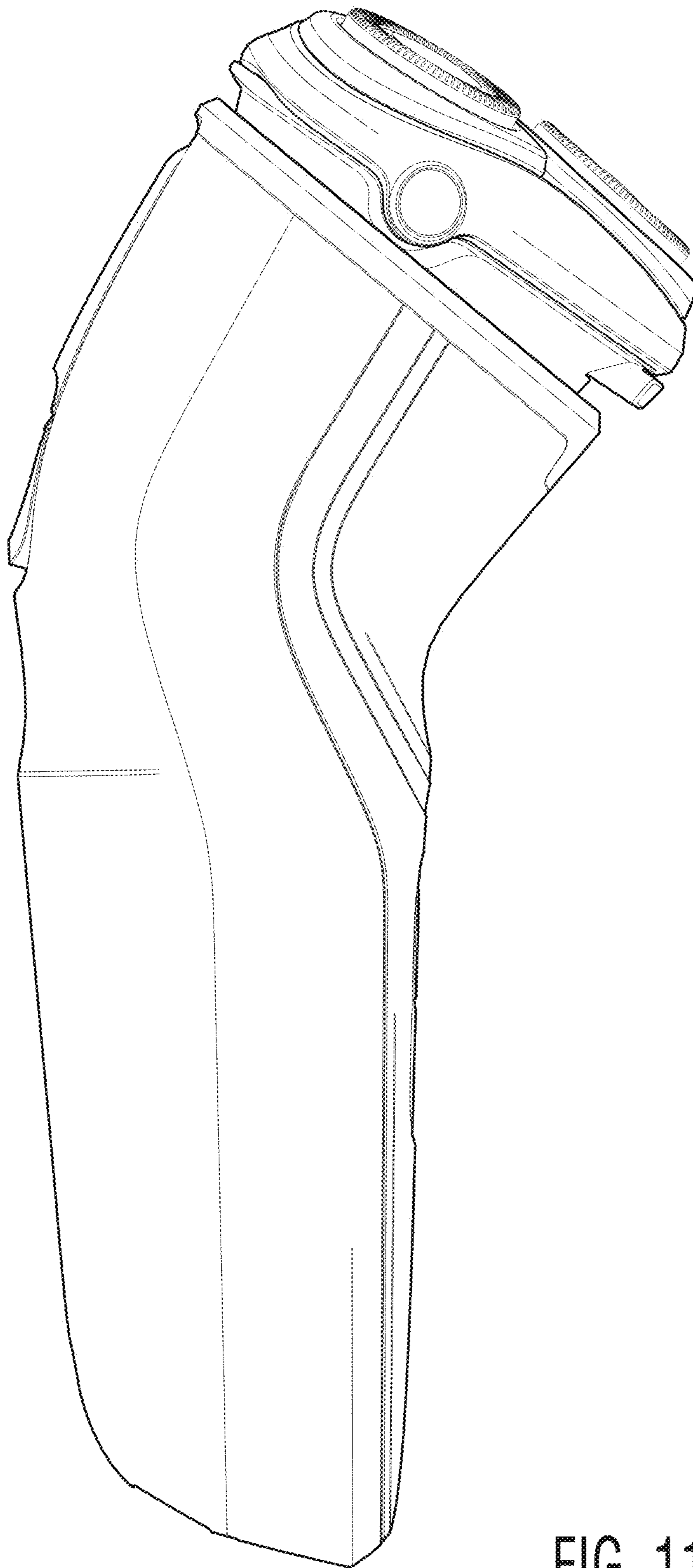

FIG. 11

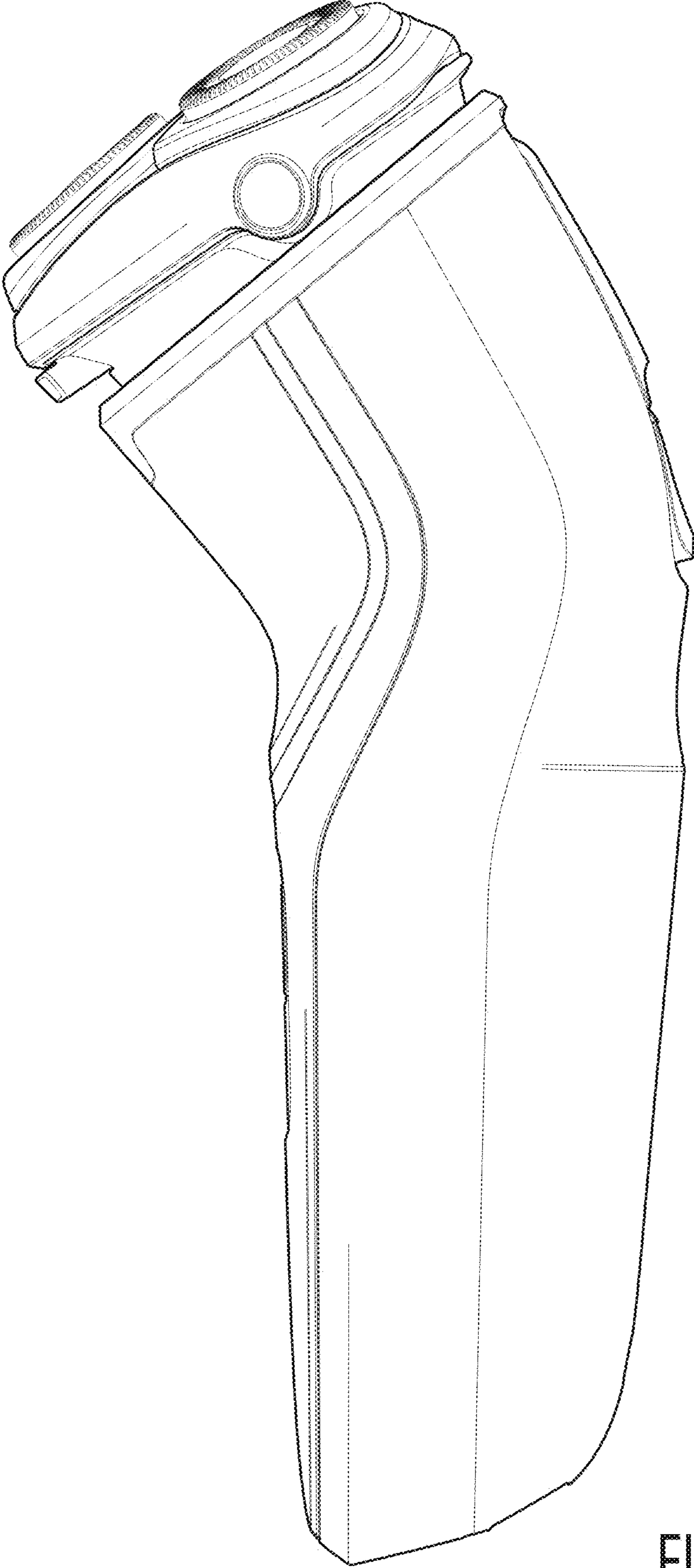

FIG. 12

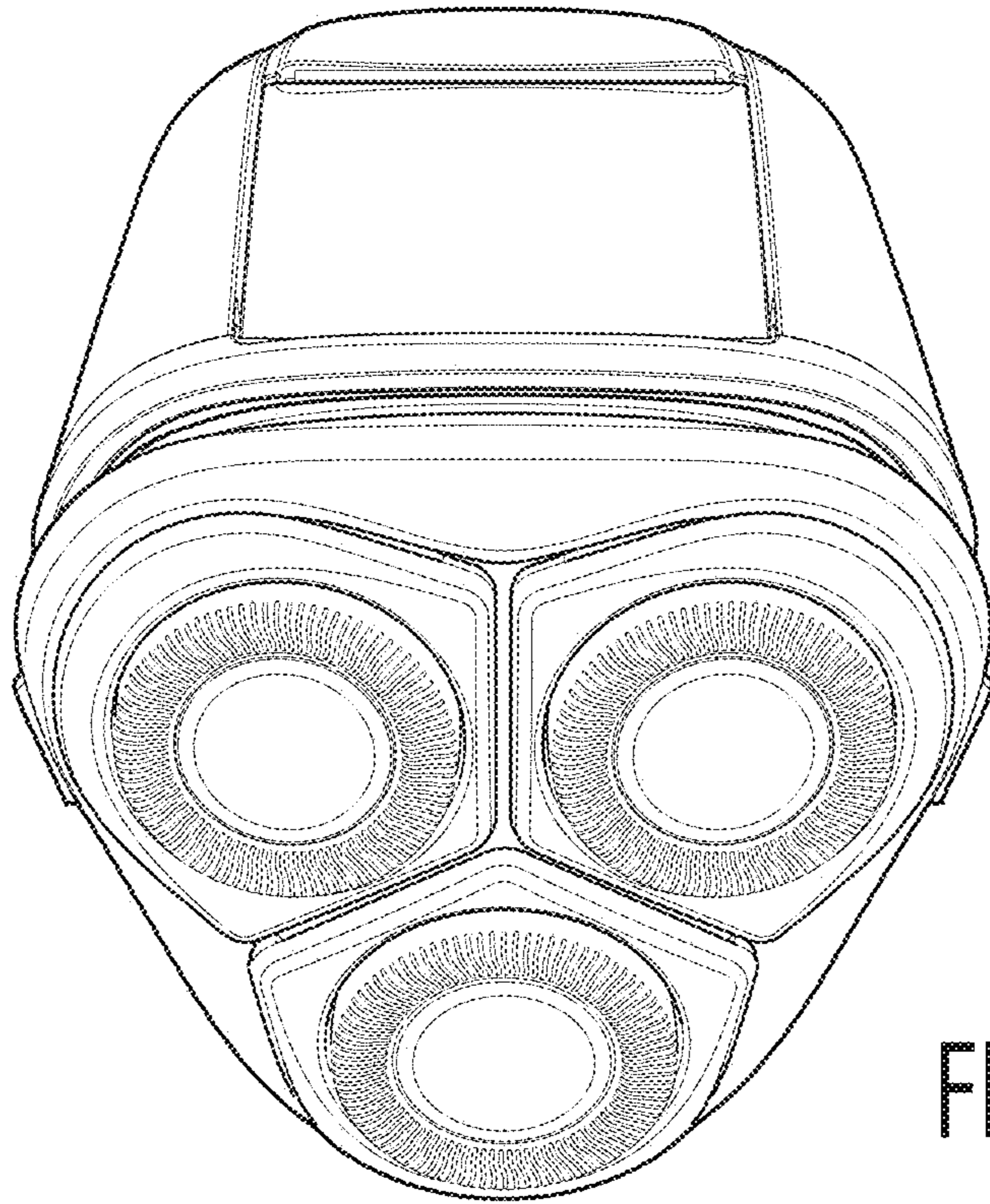

FIG. 13

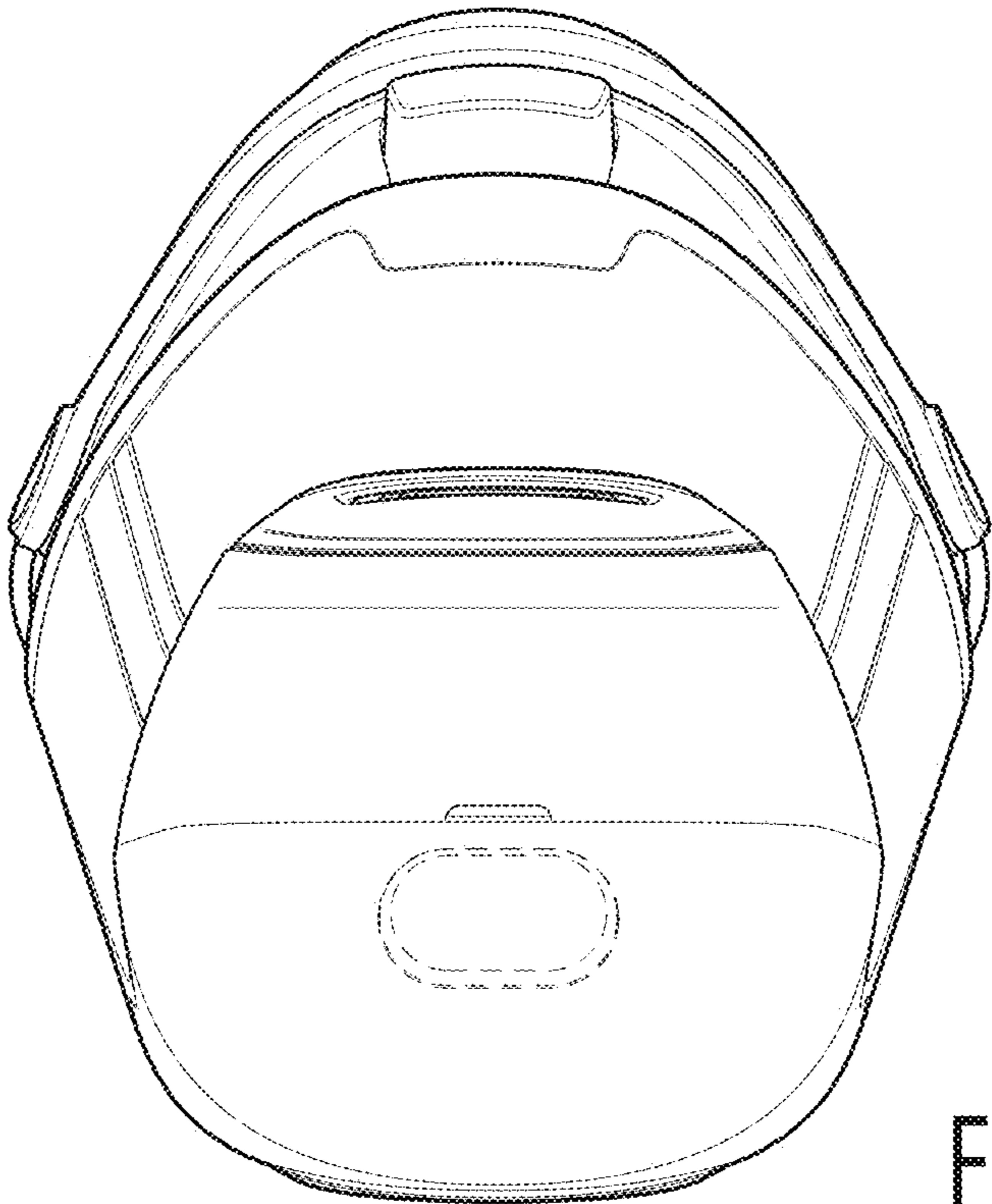

FIG. 14

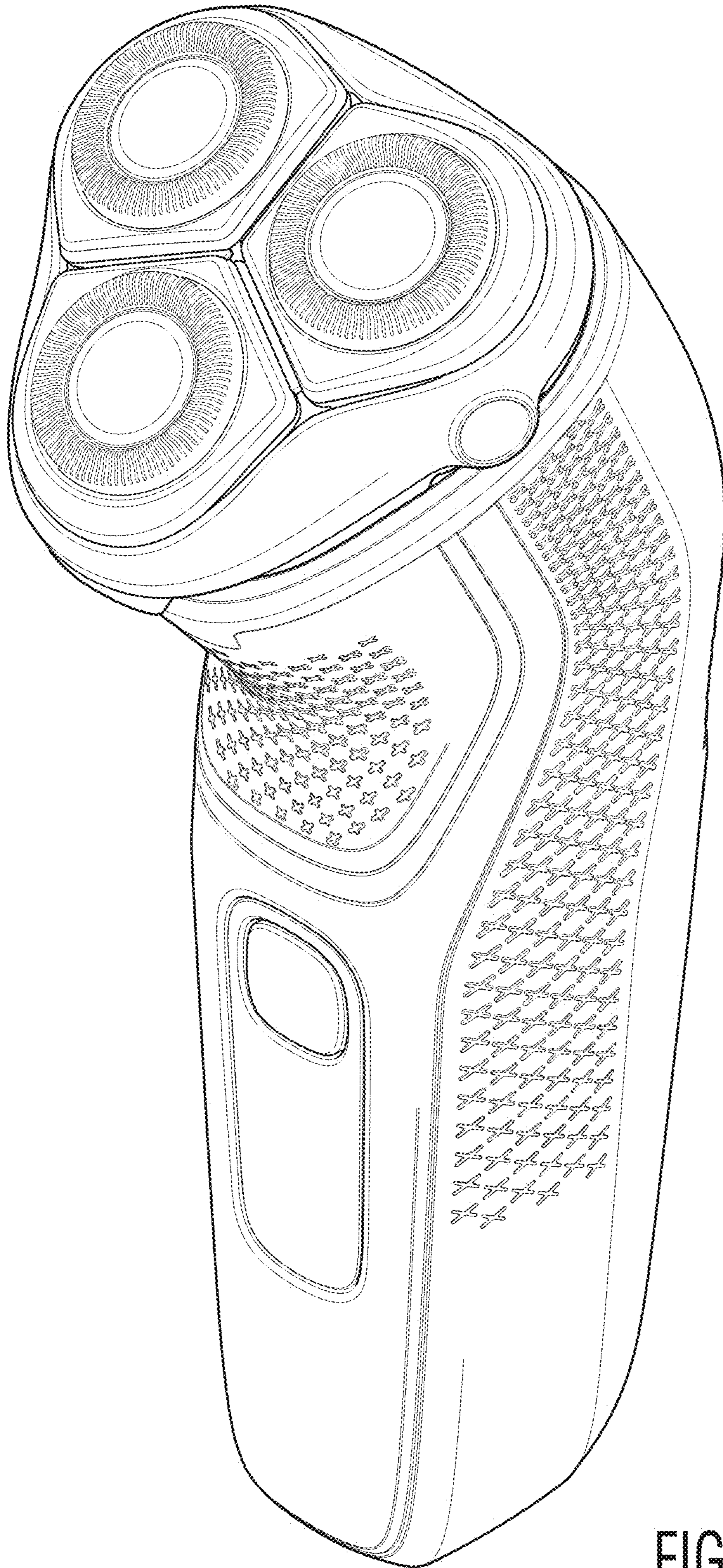

FIG. 15

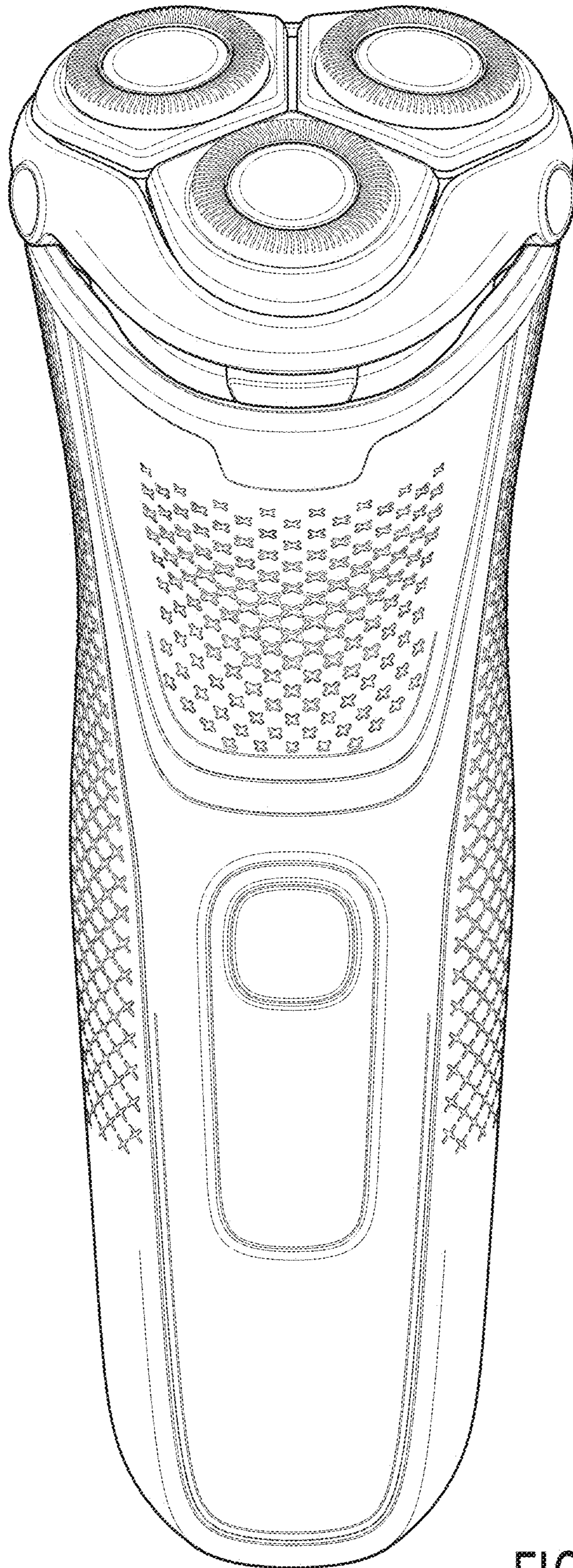

FIG. 16

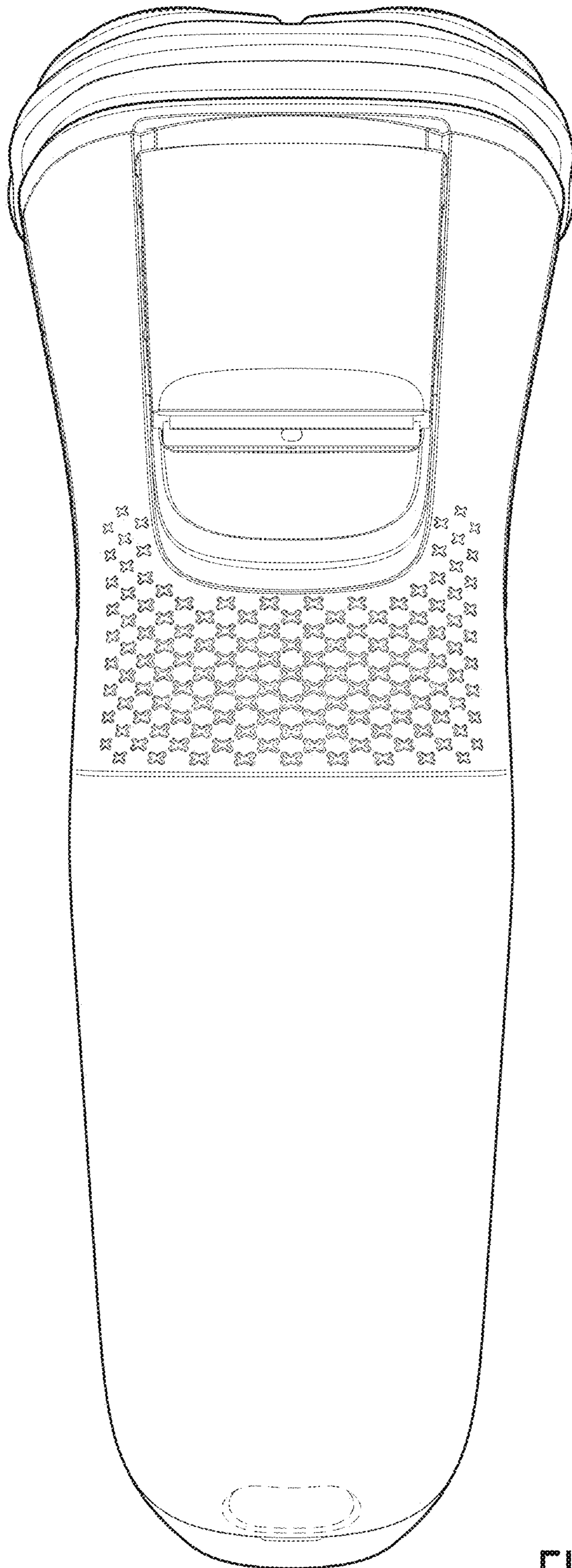

FIG. 17

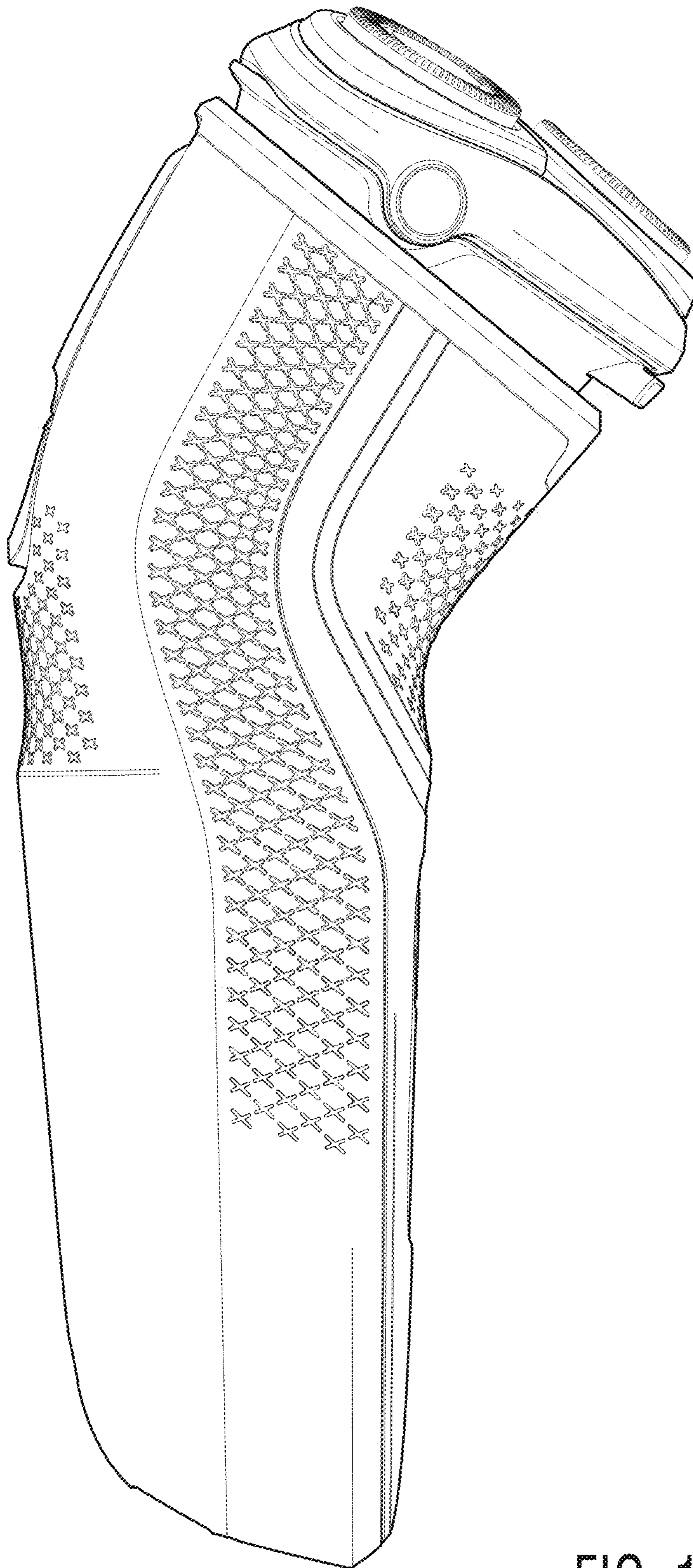

FIG. 18

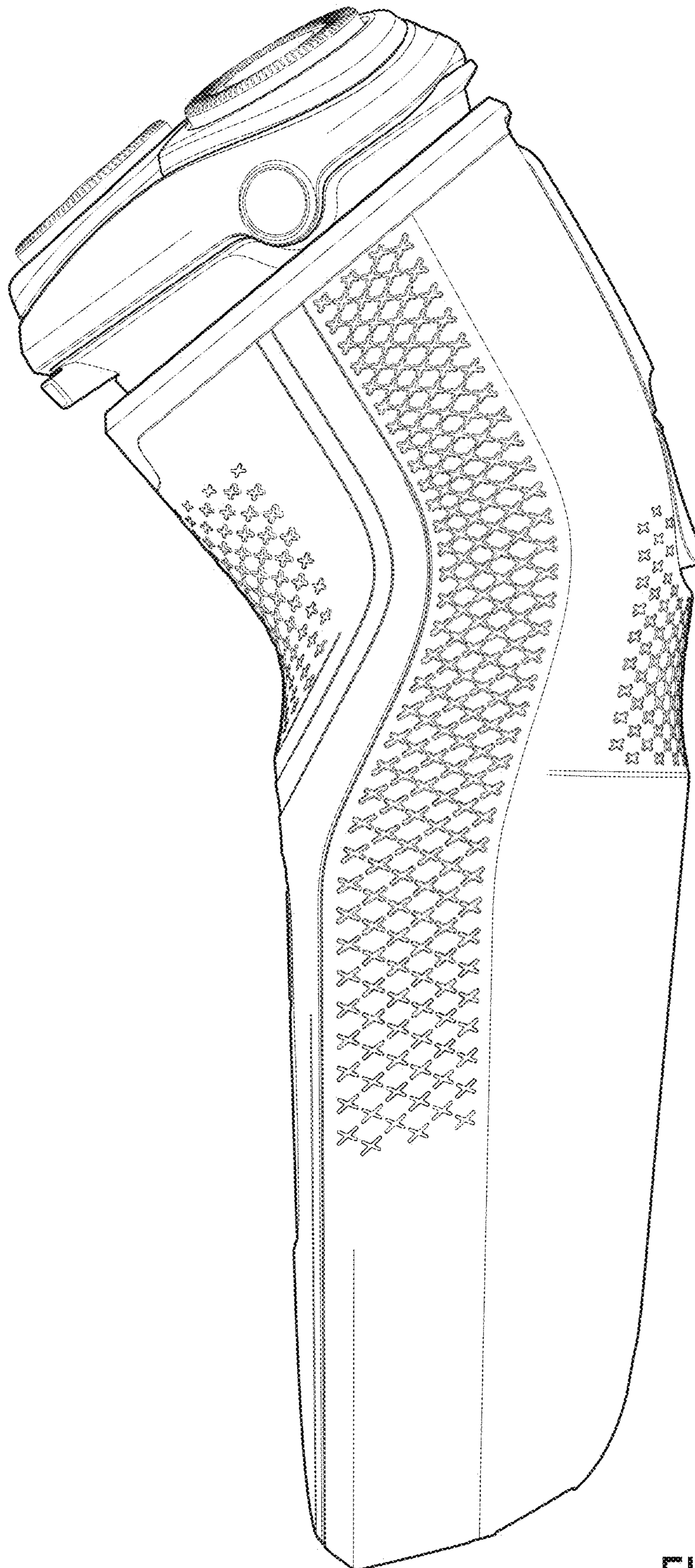

FIG. 19

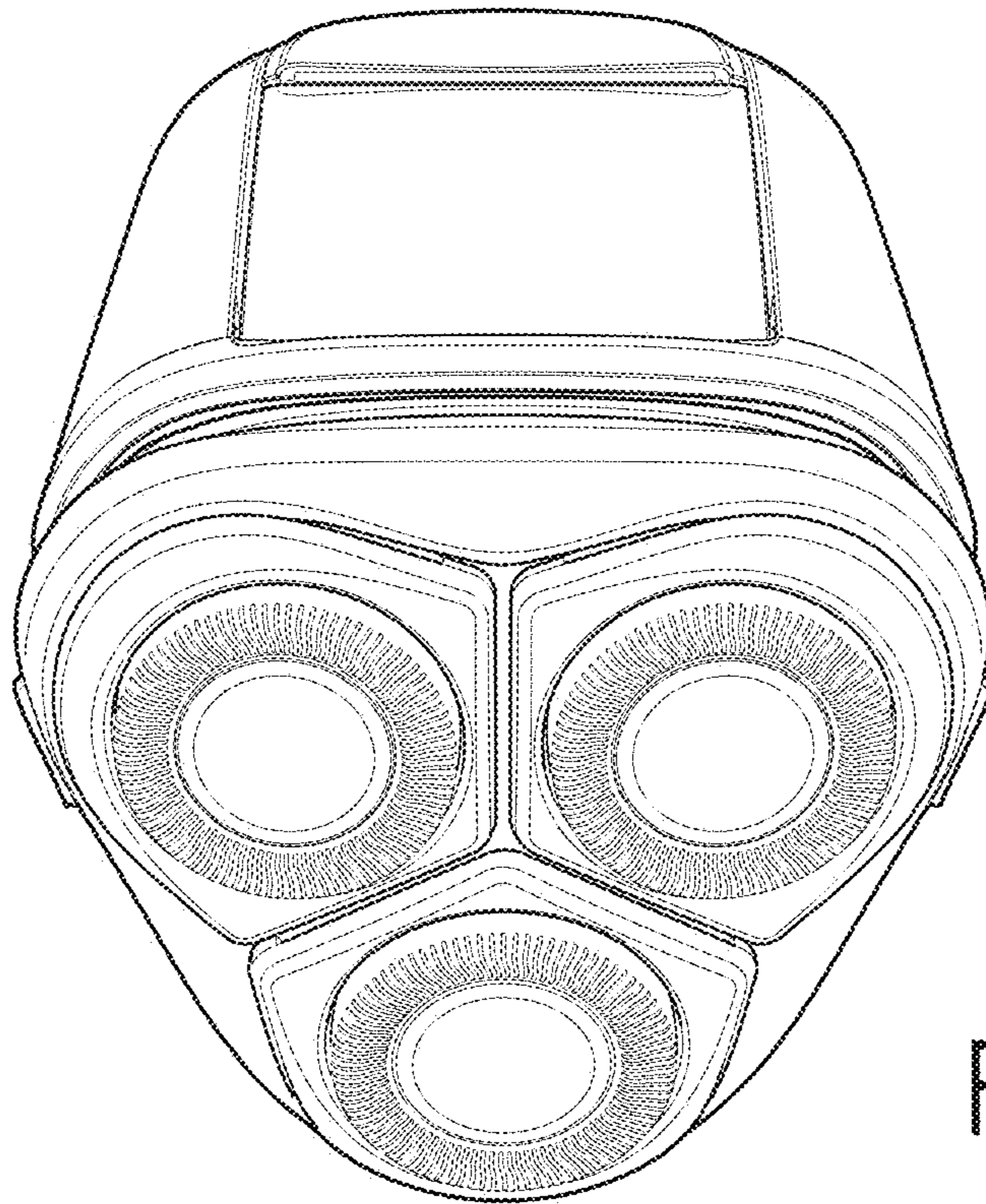

FIG. 20

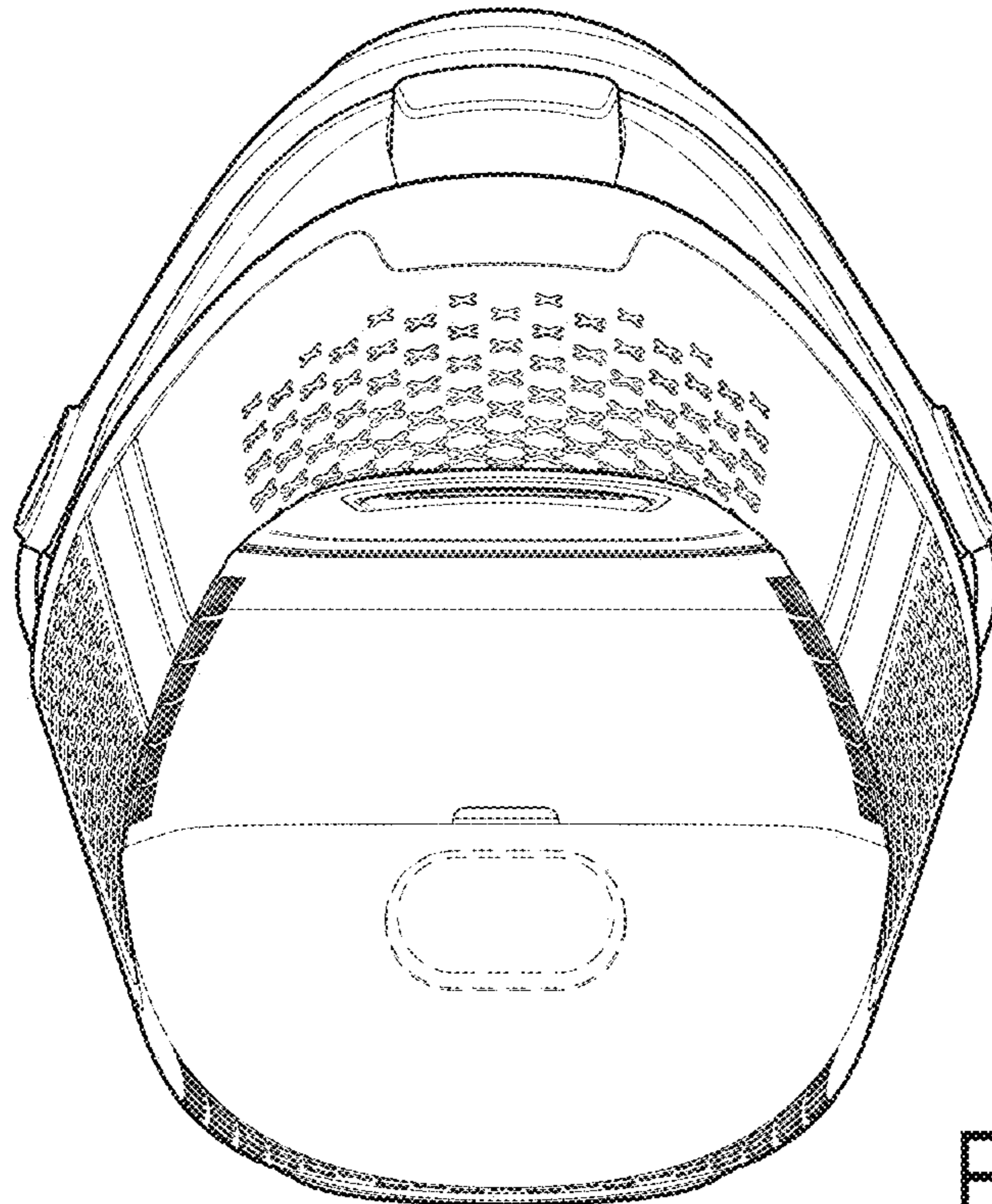

FIG. 21

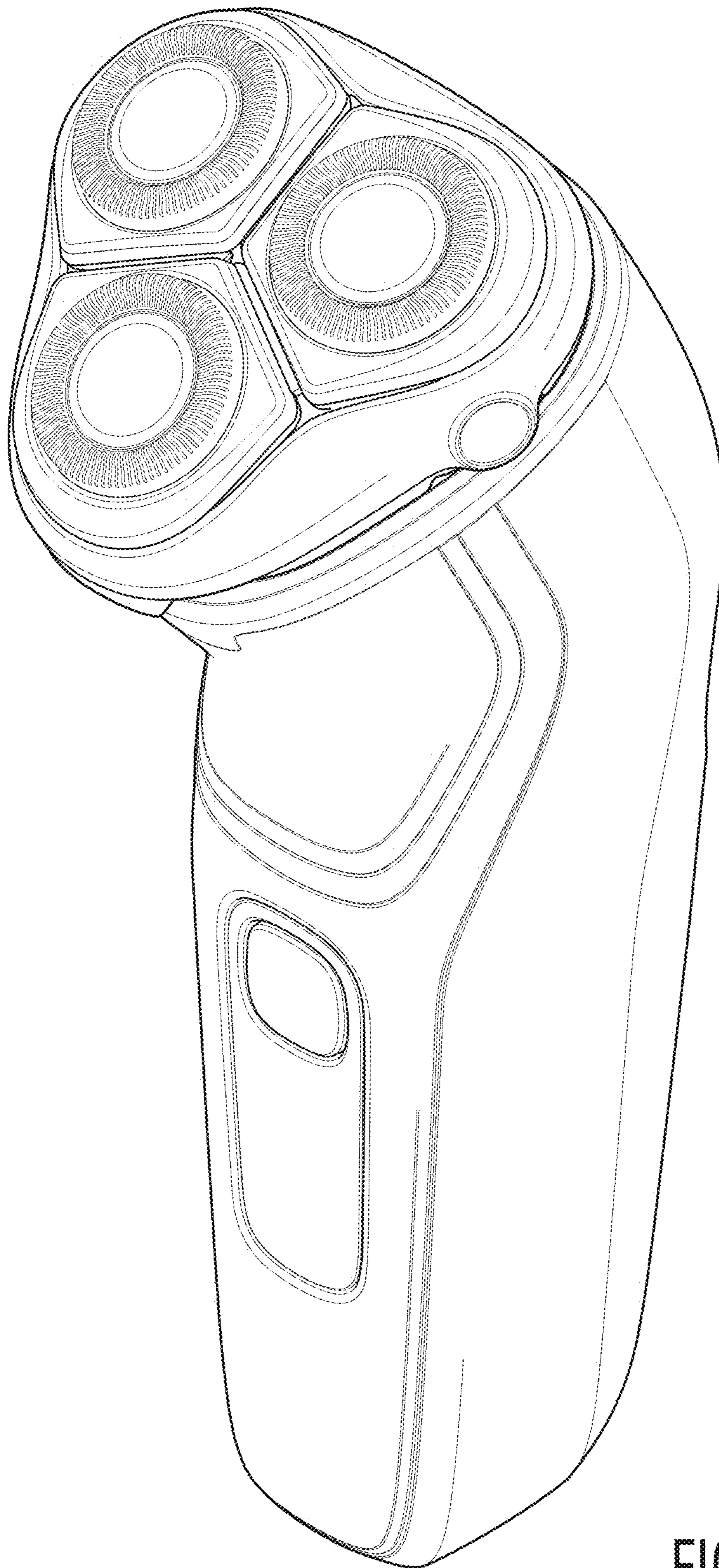

FIG. 22

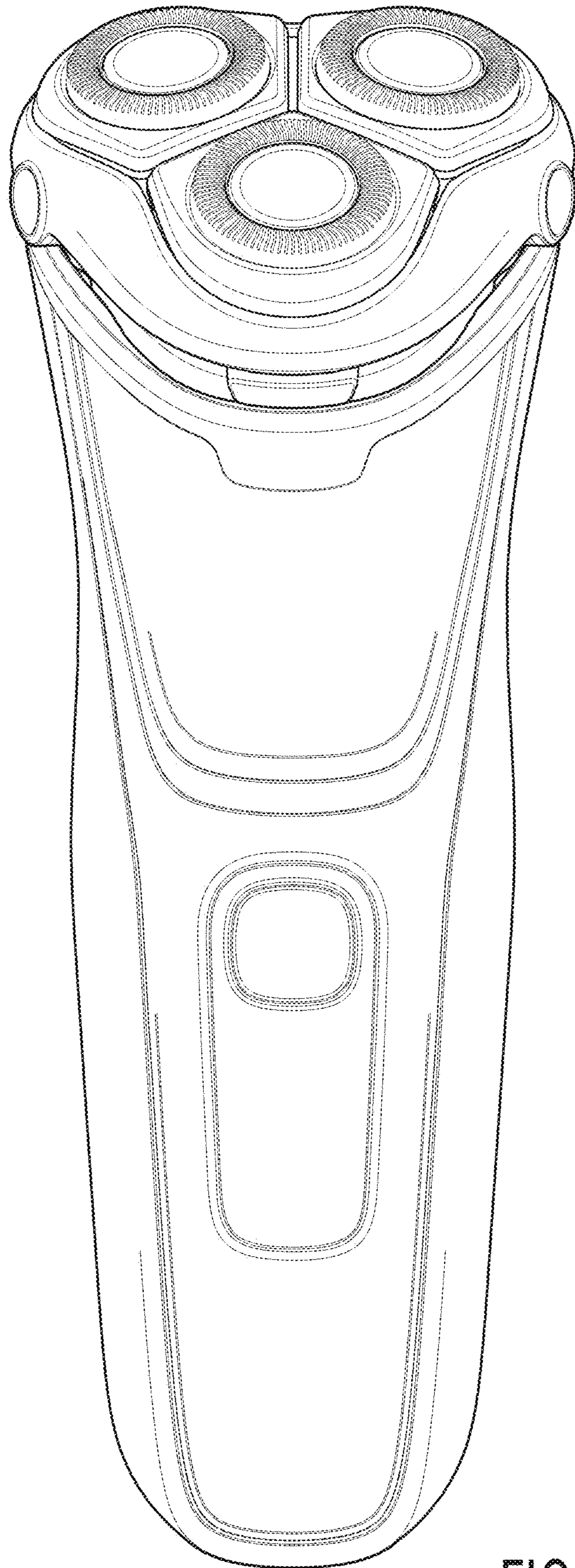

FIG. 23

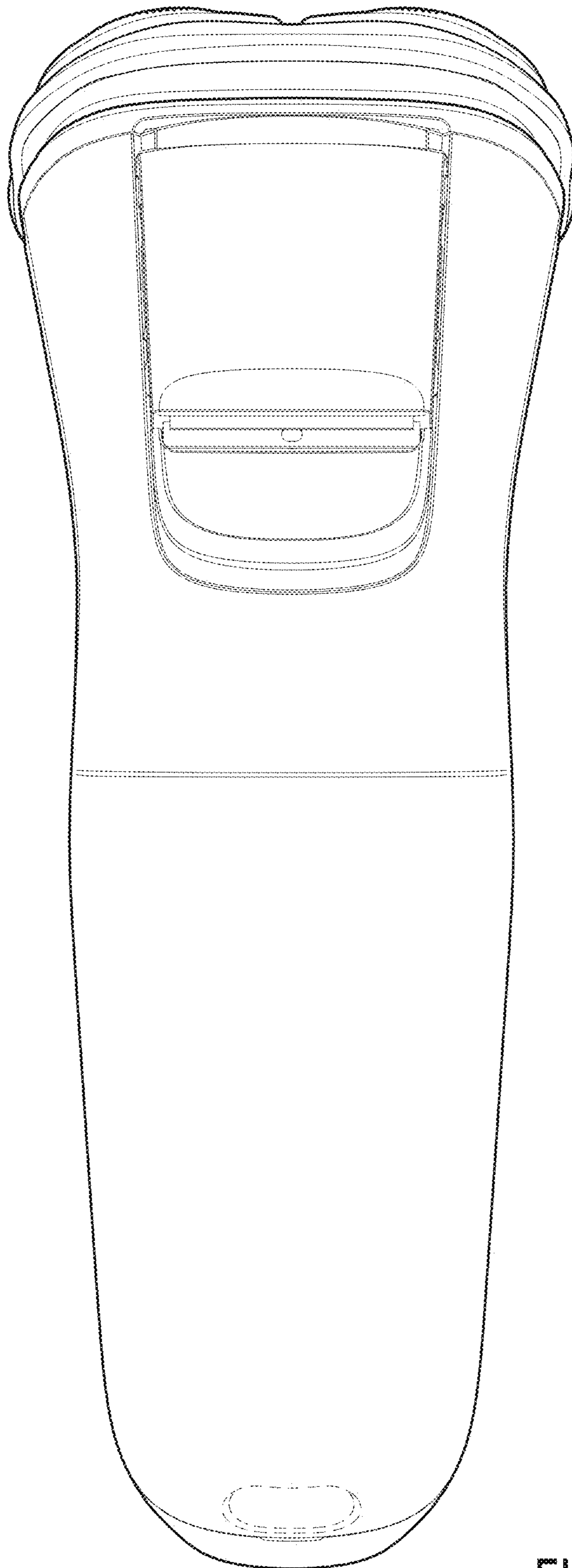

FIG. 24

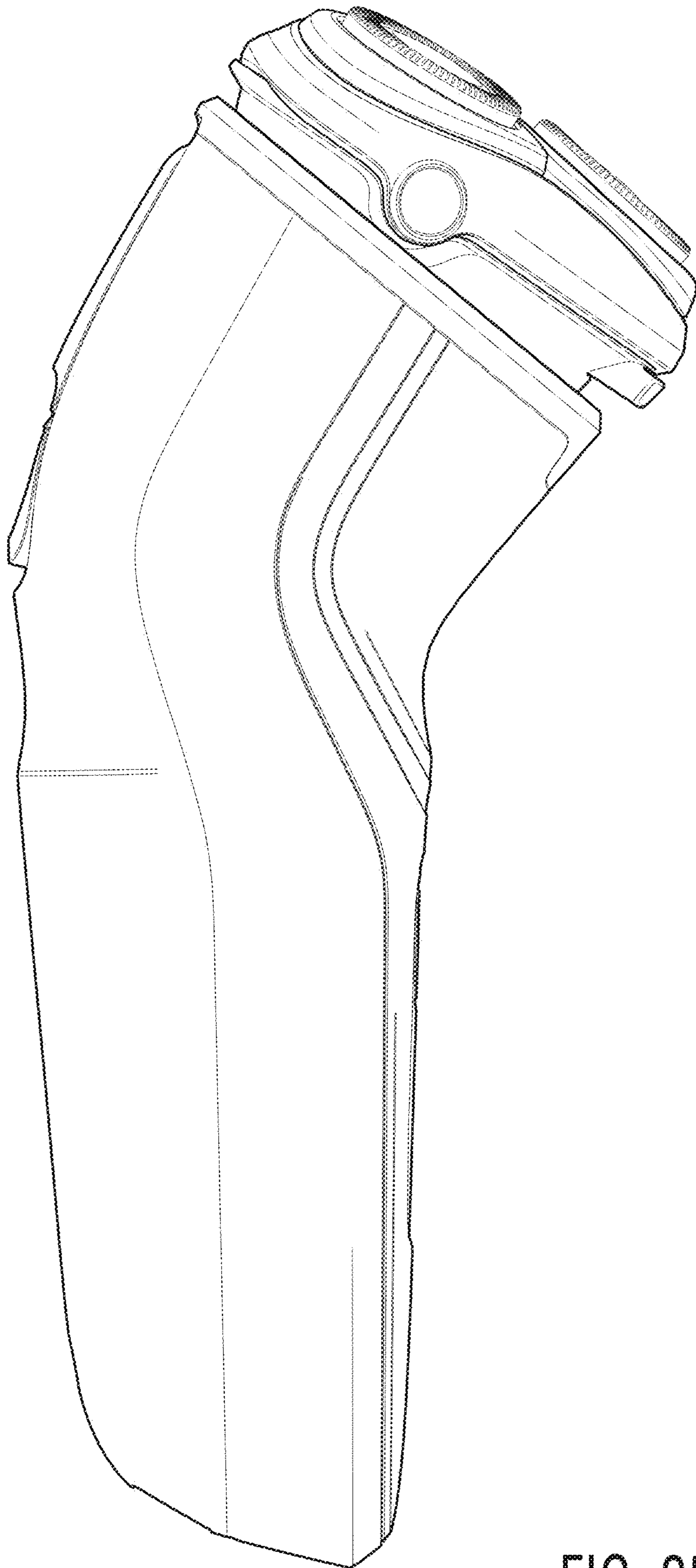

FIG. 25

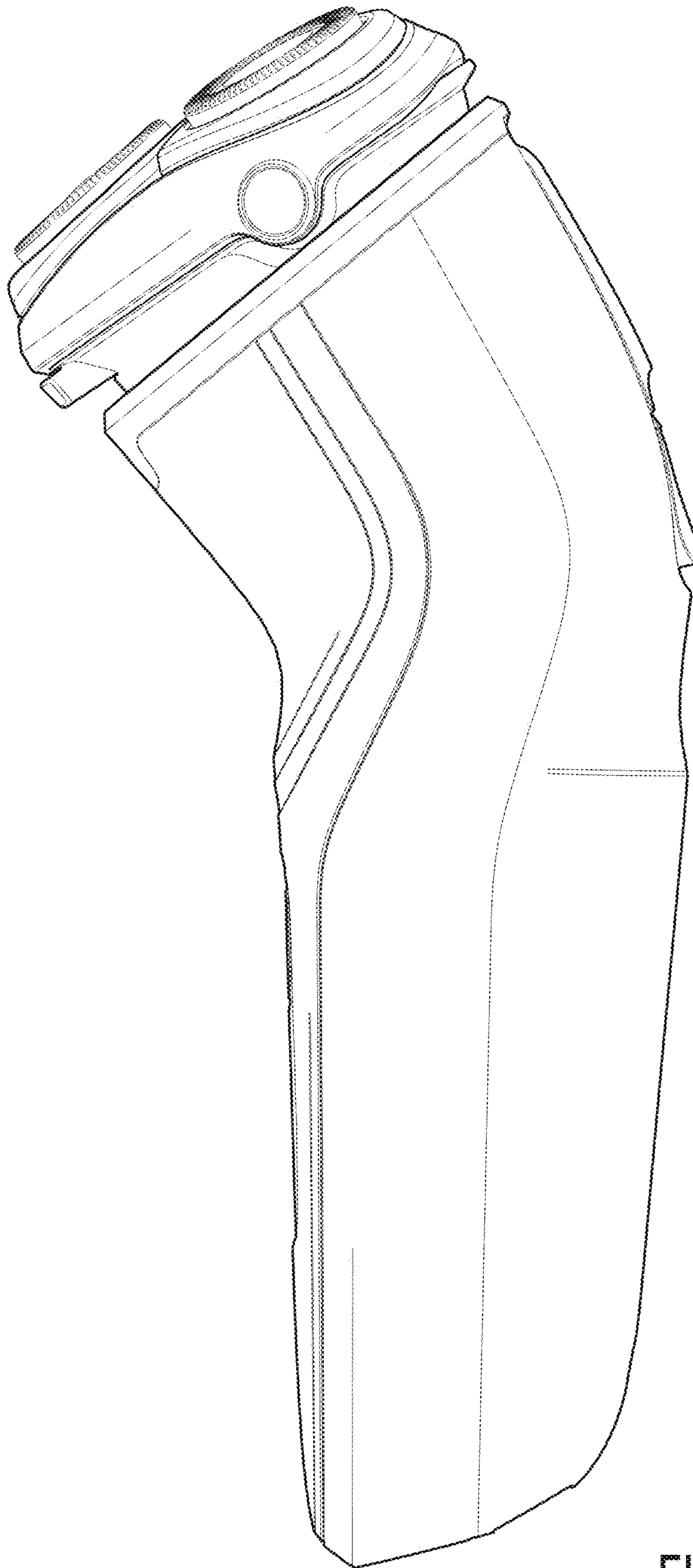

FIG. 26

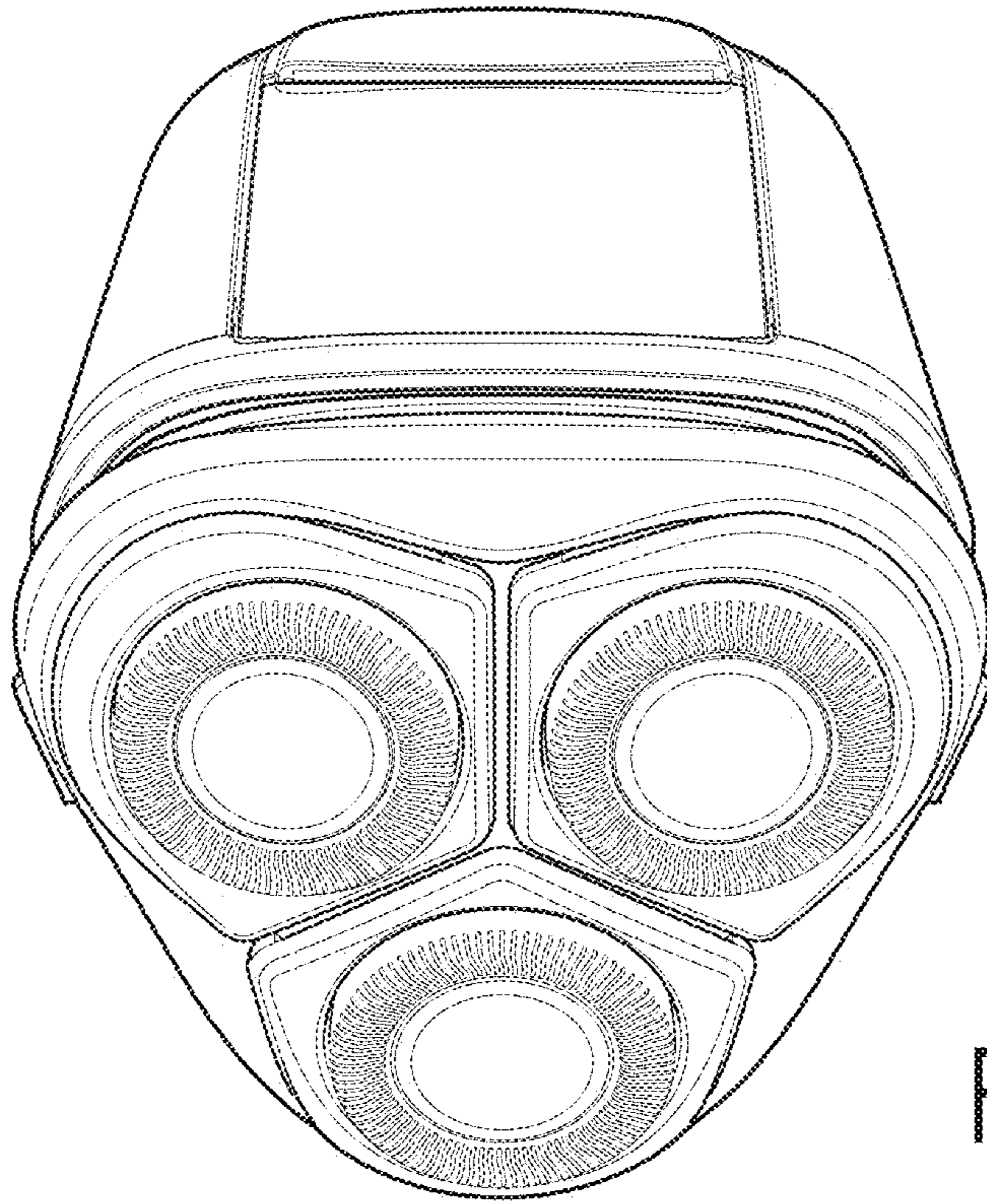

FIG. 27

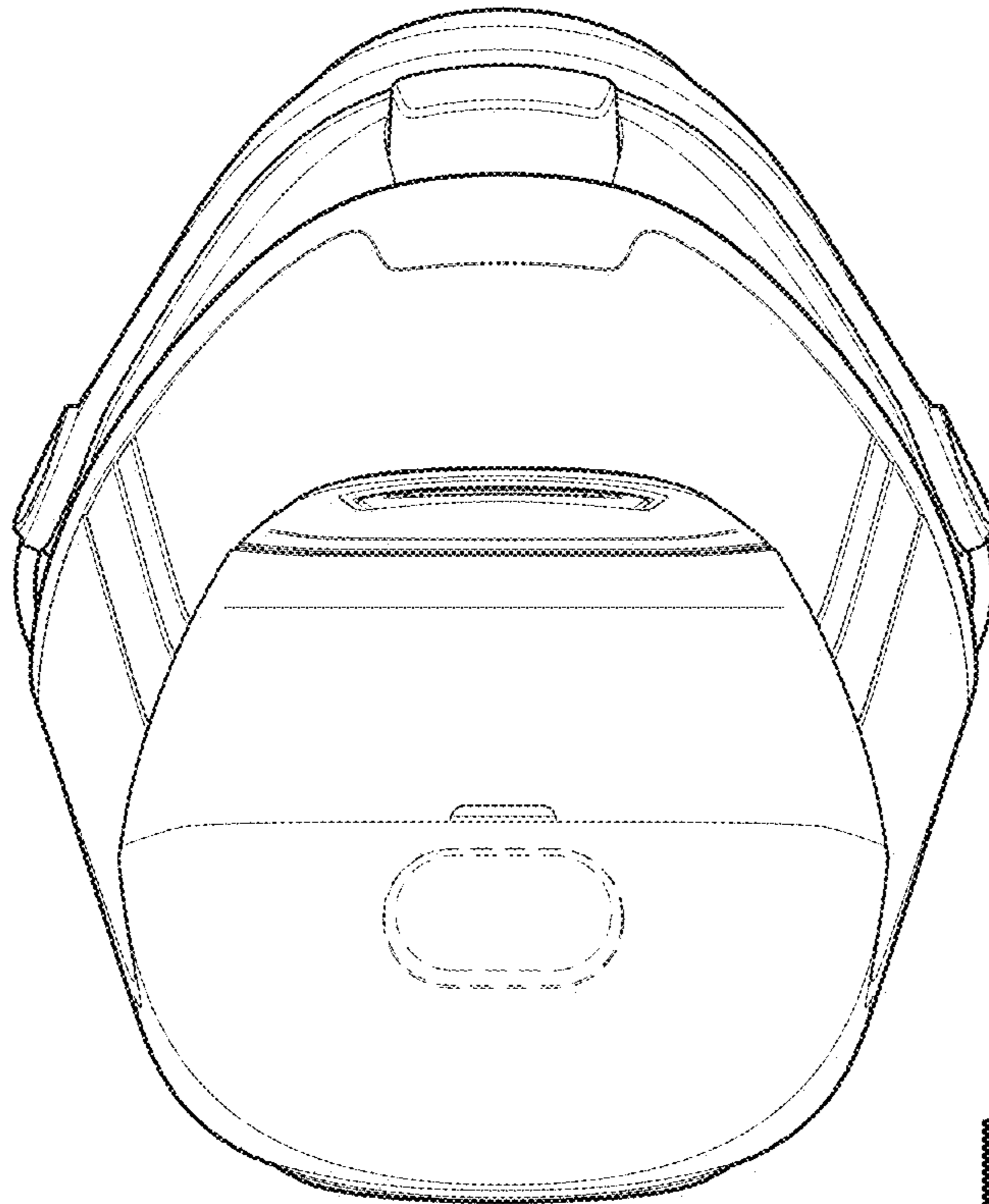

FIG. 28