



US00D955029S

(12) **United States Design Patent**
Kong

(10) **Patent No.:** **US D955,029 S**
(45) **Date of Patent:** **** Jun. 14, 2022**

(54) **LED HIGH BAY LIGHT**

(71) Applicant: **Ran Kong**, Xiantao (CN)

(72) Inventor: **Ran Kong**, Xiantao (CN)

(**) Term: **15 Years**

(21) Appl. No.: **29/773,539**

(22) Filed: **Mar. 10, 2021**

(51) **LOC (13) Cl.** **26-03**

(52) **U.S. Cl.**
USPC **D26/88; D26/72**

(58) **Field of Classification Search**
USPC D26/1, 72, 80, 88, 89
CPC F21W 2131/40; F21V 29/76; F21V 29/77;
F21V 29/777; F21V 29/78
See application file for complete search history.

(56) **References Cited**

U.S. PATENT DOCUMENTS

D845,532 S *	4/2019	Zhu	D26/72
D857,256 S	8/2019	Li		
D867,650 S *	11/2019	Cheng	D26/113
D868,332 S *	11/2019	Zhao	D26/72
D868,336 S	11/2019	Li		
D875,292 S	2/2020	Zhou et al.		
D906,566 S *	12/2020	Li	D26/72
D917,758 S *	4/2021	Pi	D26/72
D929,010 S *	8/2021	Zeng	D26/72
2013/0308314 A1 *	11/2013	Wung	F21K 9/20 362/249.02
2019/0293267 A1 *	9/2019	Marshal	F21V 23/0471

OTHER PUBLICATIONS

Shinewoo UFO High Bay Light, ASIN: B08KP6LZCX. Available at amazon.com Nov. 15, 2020. (Year: 2020).*
Antlux UFO High Bay LED Light, ASIN: B077ZLMTH9. Available at amazon.com Dec. 7, 2017. (Year: 2017).*

* cited by examiner

Primary Examiner — Clare E Heflin

(74) *Attorney, Agent, or Firm* — Che-Yang Chen; Law Office of Michael Chen

(57) **CLAIM**

The ornamental design for an LED high bay light, as shown and described.

DESCRIPTION

FIG. 1 is a perspective view of the LED high bay light showing my new design;
FIG. 2 is a perspective view from another angle thereof;
FIG. 3 is a bottom plan view thereof;
FIG. 4 is a top plan view thereof.
FIG. 5 is a left side elevational view thereof;
FIG. 6 is a right side elevational view thereof;
FIG. 7 is a front elevational view thereof; and,
FIG. 8 is a rear elevational view thereof.

The broken lines shown on the drawings depict portions of the LED high bay light that form no part of the claimed design.

1 Claim, 8 Drawing Sheets

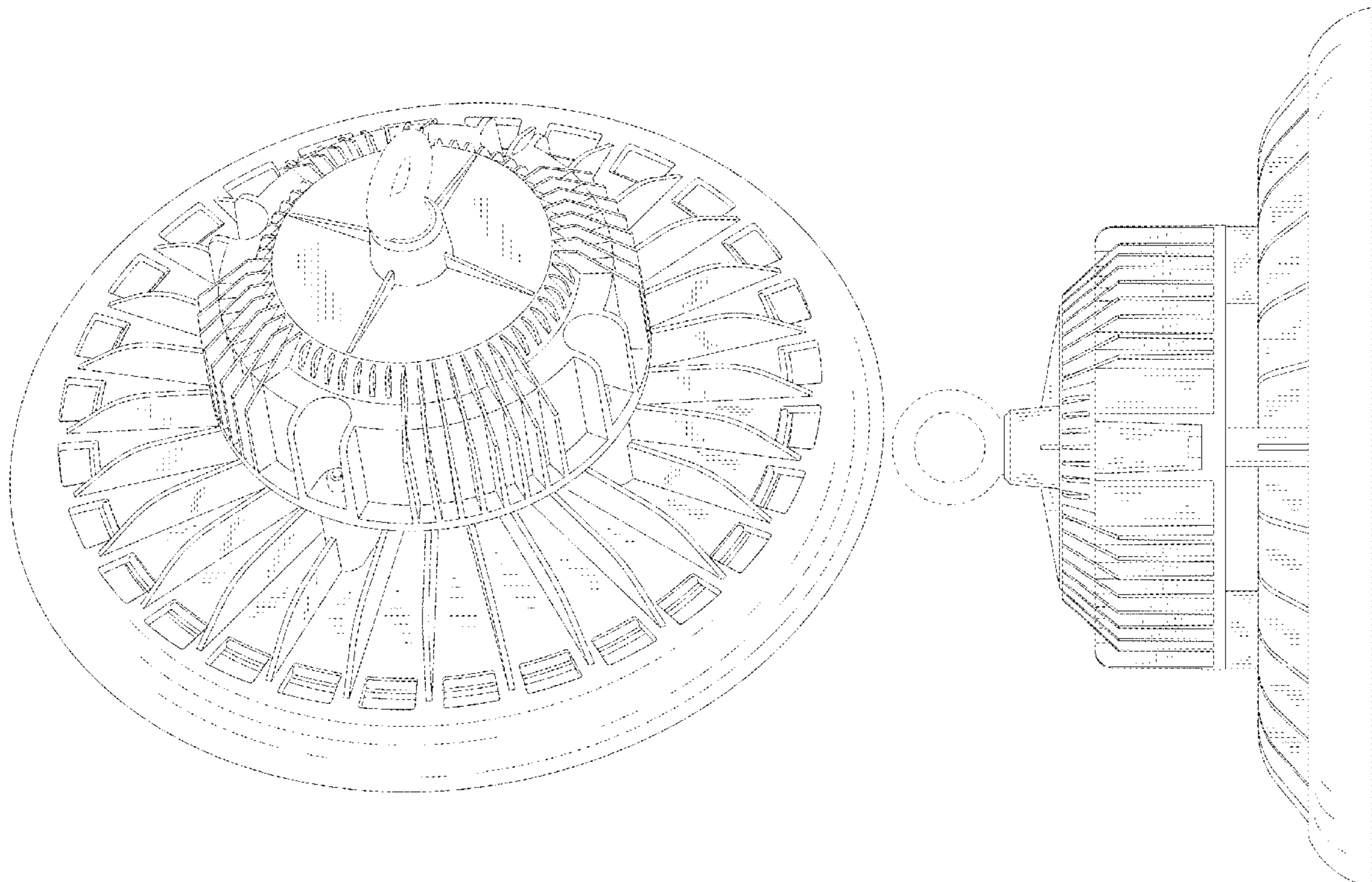

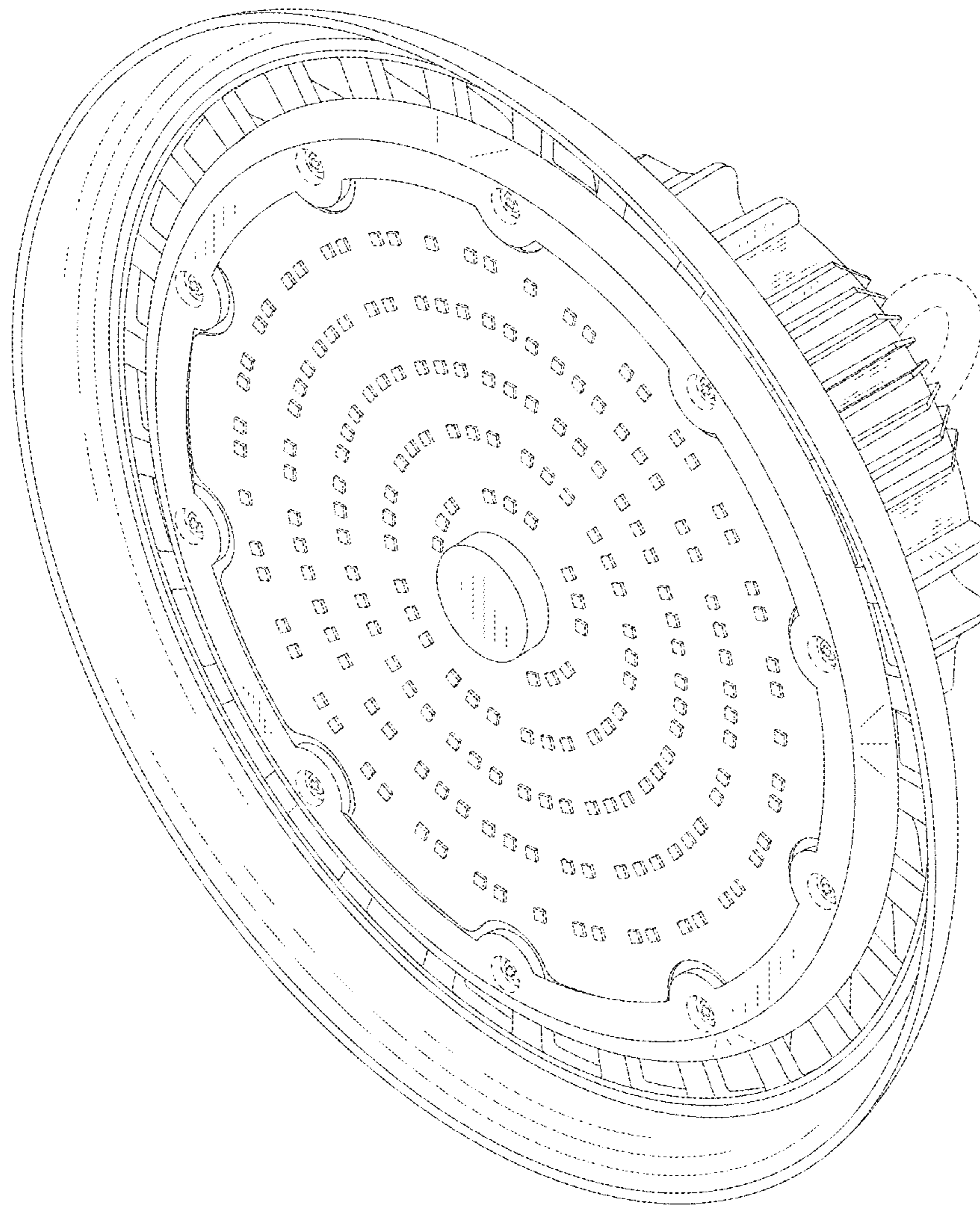

FIG.1

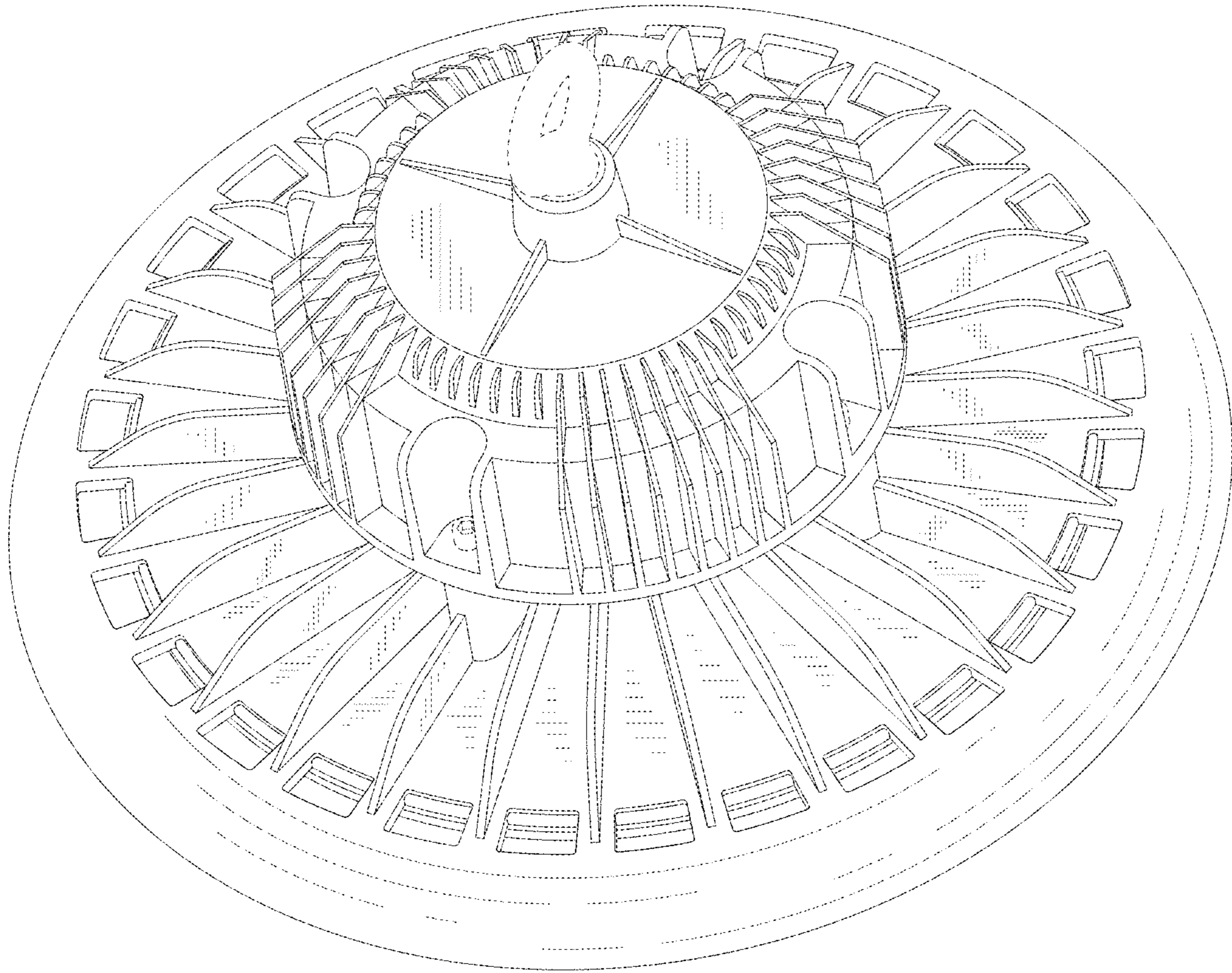

FIG. 2

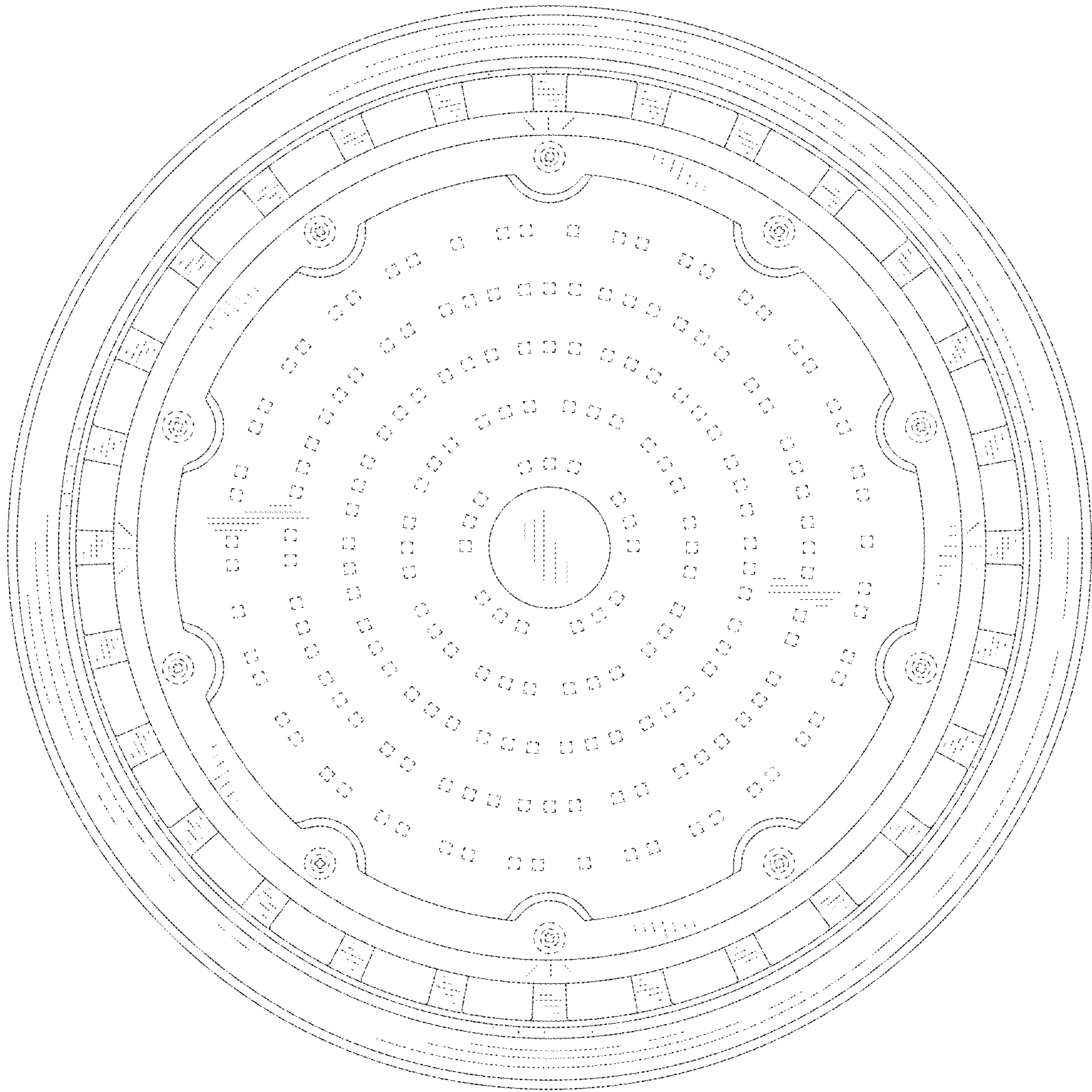

FIG. 3

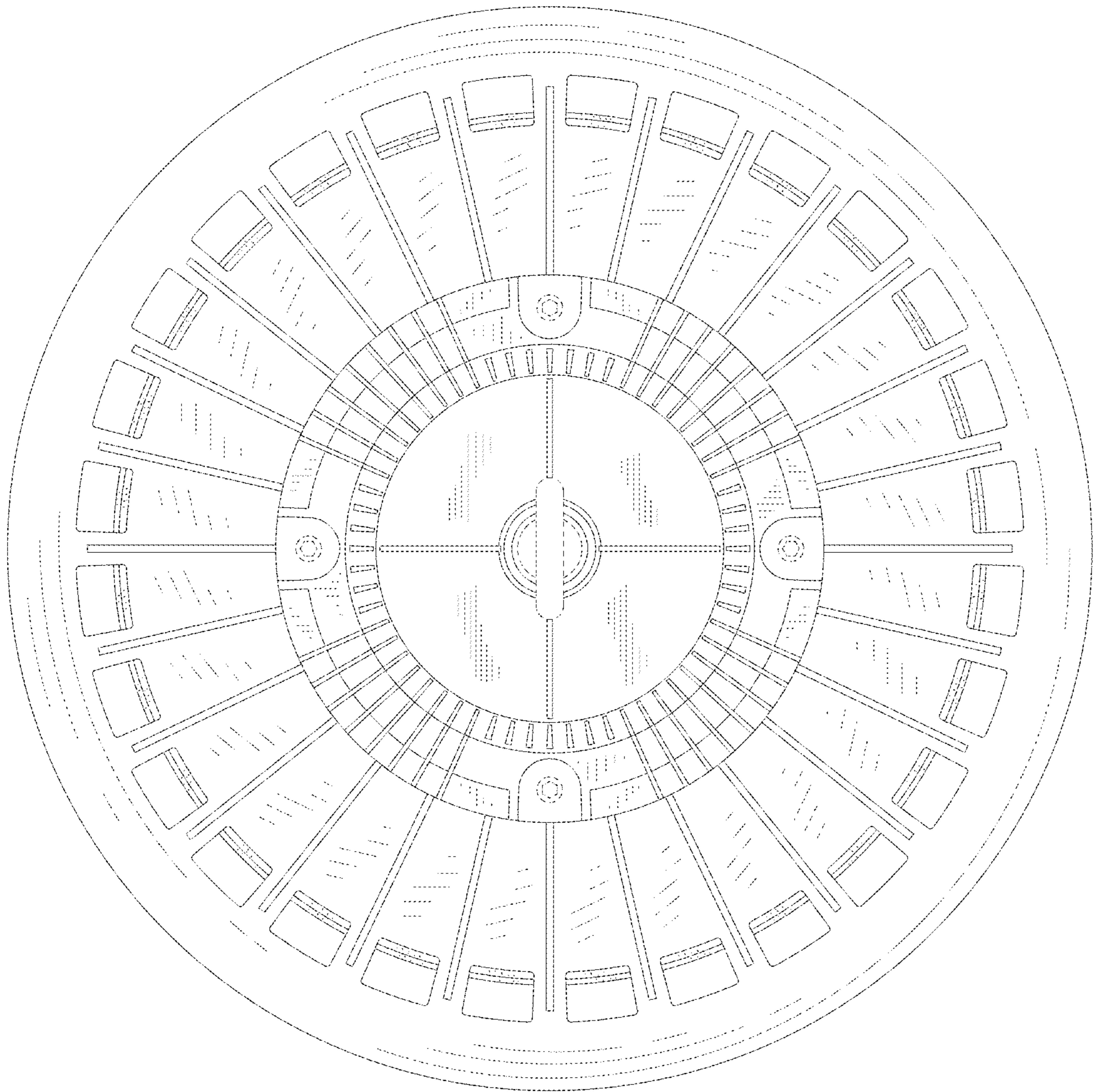

FIG. 4

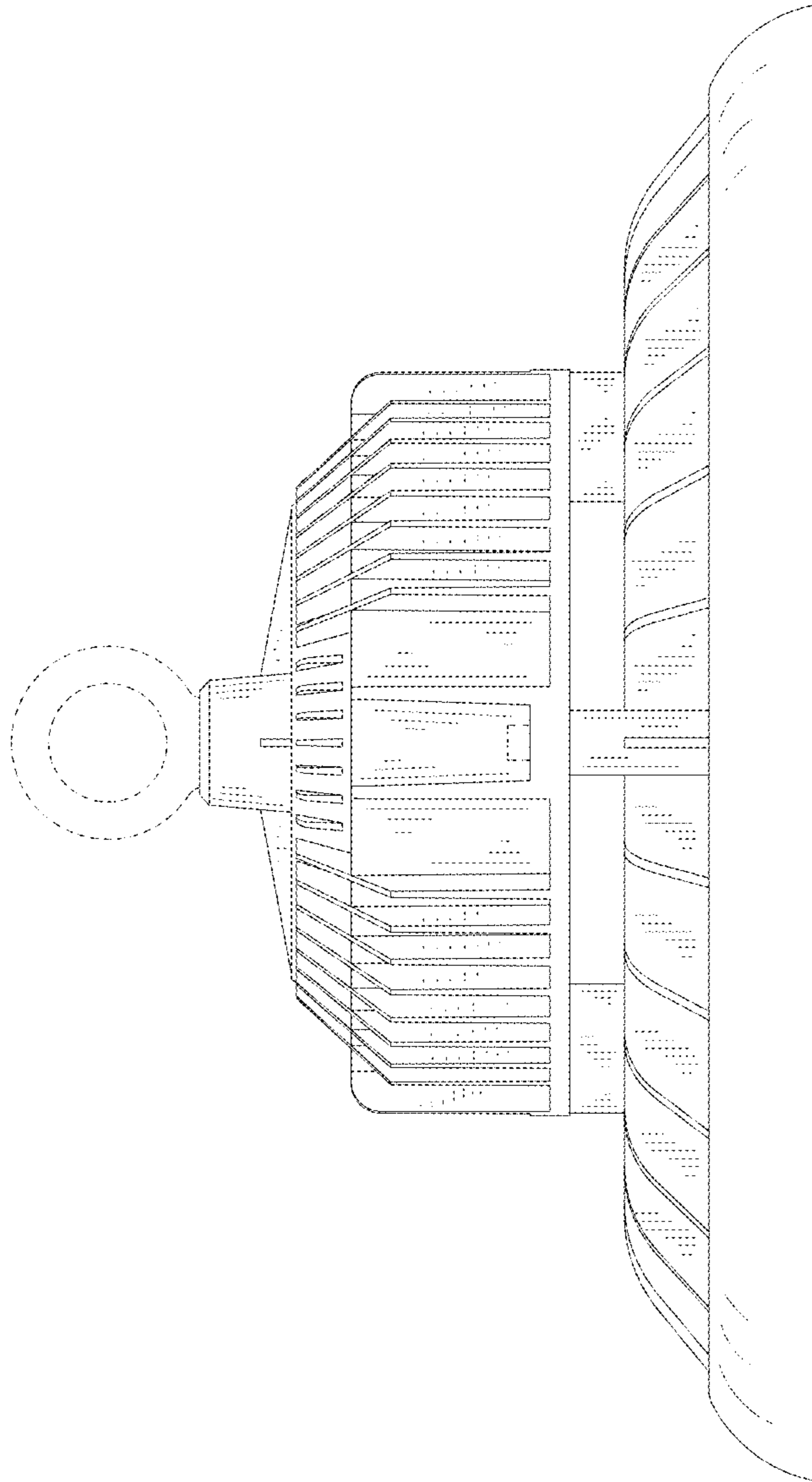

FIG. 5

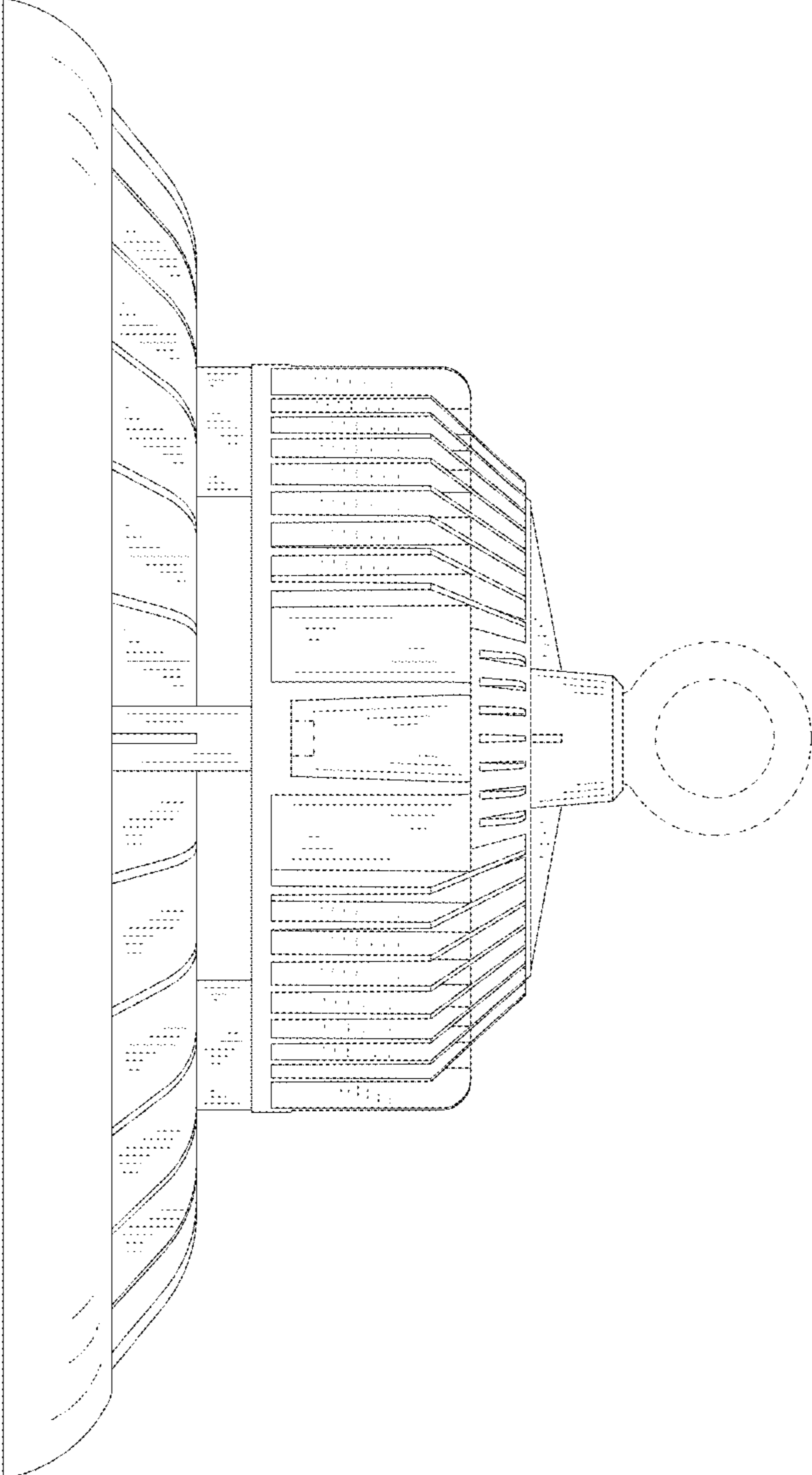

FIG. 6

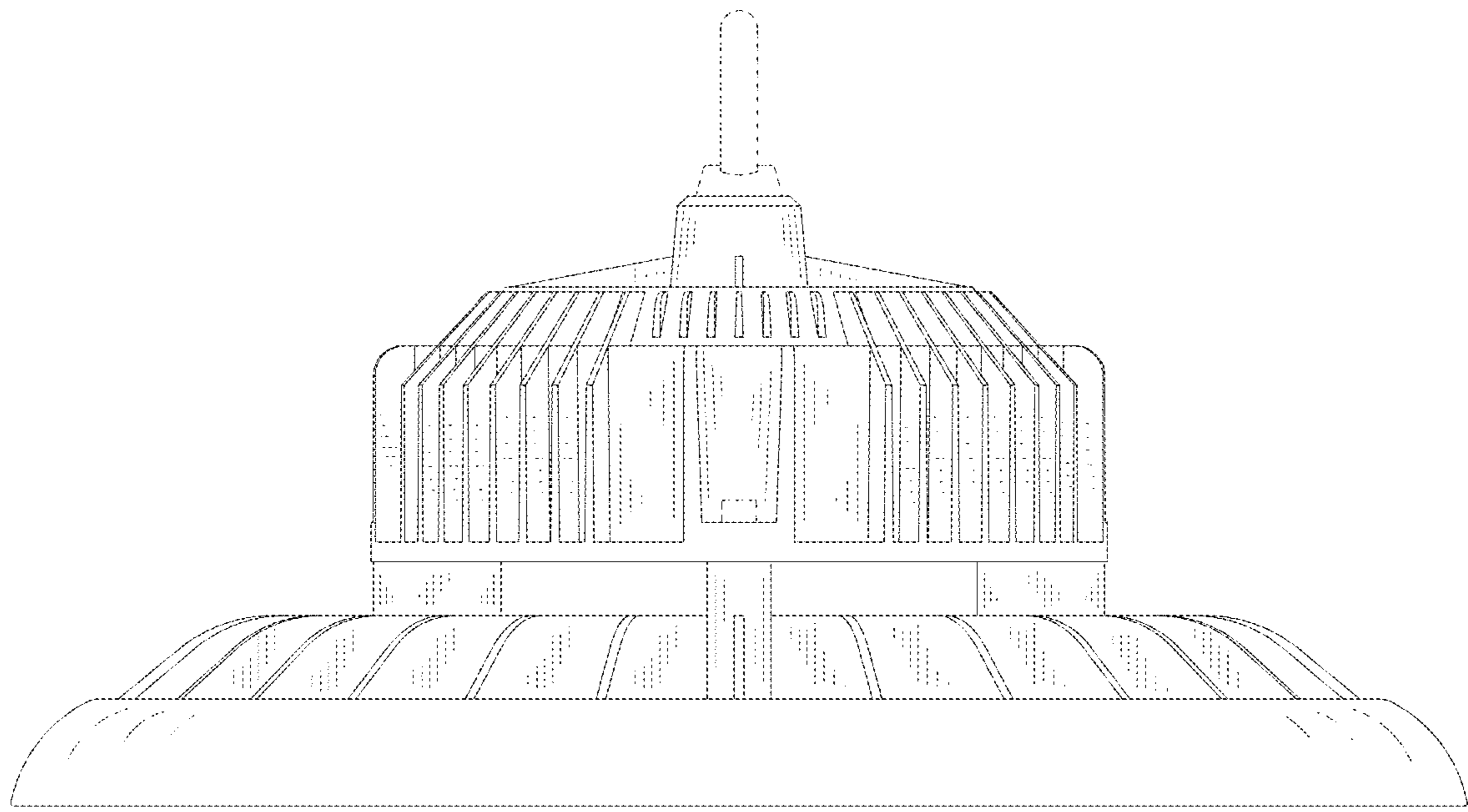

FIG. 7

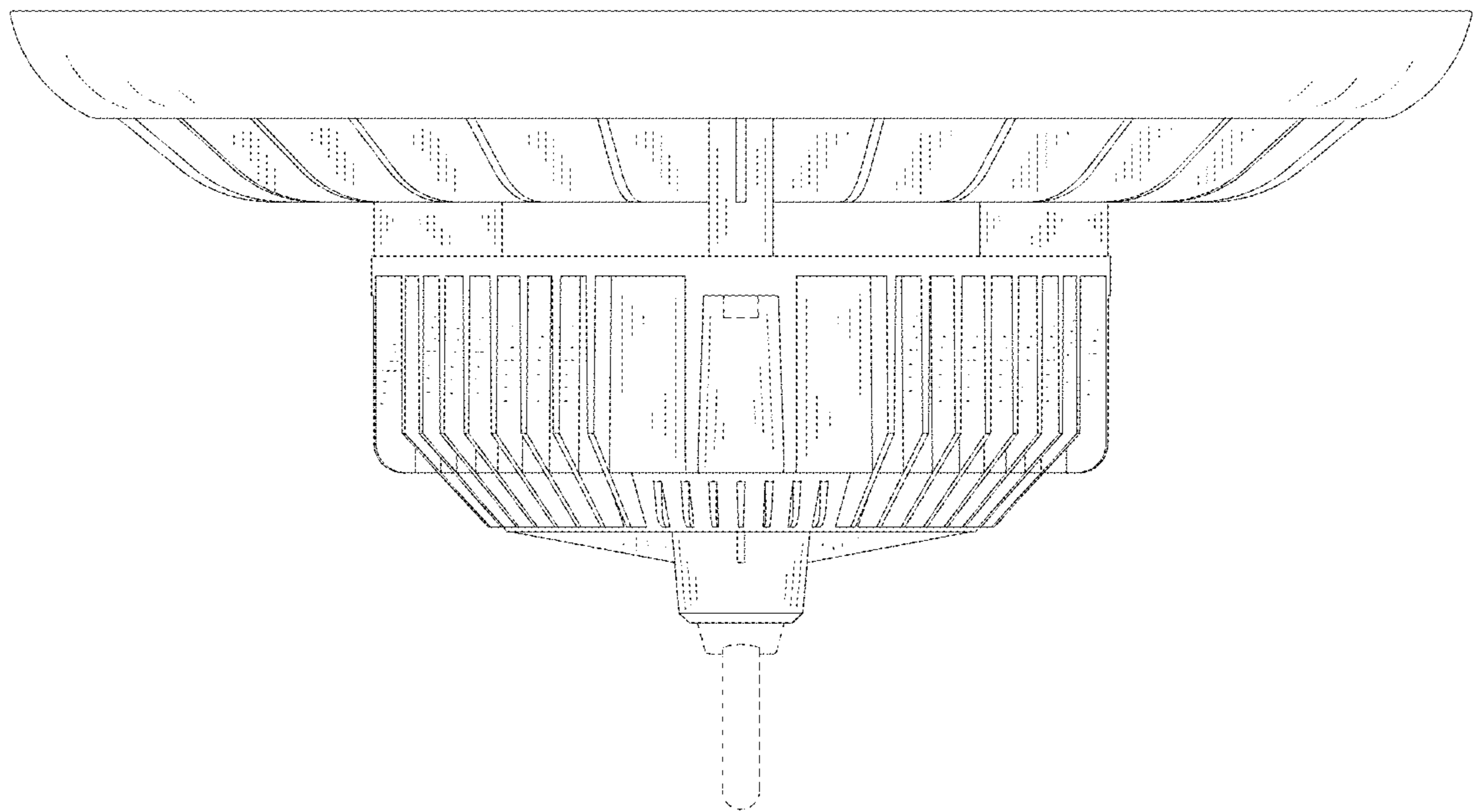

FIG. 8