



US00D954984S

(12) **United States Design Patent** (10) **Patent No.:** **US D954,984 S**
Bonnoitt, Jr. et al. (45) **Date of Patent:** **** Jun. 14, 2022**

(54) **THERMOFORMED CONTAINER**
(71) Applicant: **Integra Biosciences AG**, Zizers (CH)
(72) Inventors: **George K. Bonnoitt, Jr.**, Amherst, NH (US); **Christopher LaCroix**, Bedford, NH (US)
(73) Assignee: **Integra Biosciences AG**, Zizers (CH)
(**) Term: **15 Years**
(21) Appl. No.: **29/714,769**
(22) Filed: **Nov. 26, 2019**
(51) **LOC (13) Cl.** **24-02**
(52) **U.S. Cl.**
USPC **D24/224**; D24/216; D24/223
(58) **Field of Classification Search**
USPC D24/108, 127-130, 216, 222-232;
D9/432, 756-758; D6/406.1-406.3,
D6/406.6; D3/294, 295, 203.1, 304
CPC ... B01L 9/543; B65D 21/0219; B65D 25/205;
B65D 45/20
See application file for complete search history.

(56) **References Cited**
U.S. PATENT DOCUMENTS
4,915,251 A * 4/1990 Payne B65D 85/324
220/4.23
D332,680 S * 1/1993 Ramirez D24/131
D341,237 S * 11/1993 DeBusk D24/131
5,392,914 A 2/1995 Lemieux et al.
(Continued)

OTHER PUBLICATIONS
Tech Team Innovation Experts. Online, published date unknown.
Retrieved on Jun. 25, 2021 from URL: <https://www.kiefel.com/en/Kiefel-Packaging/Tech-Team>.
(Continued)

Primary Examiner — Omeed Agilee
(74) *Attorney, Agent, or Firm* — Andrus Intellectual Property Law

(57) **CLAIM**

The ornamental design for a thermoformed container, as shown and described.

DESCRIPTION

FIG. 1 is a front perspective view of a first embodiment of a thermoformed container showing the new design; FIG. 2 is a front side elevation view of the first embodiment; FIG. 3 is a rear side elevation view of the first embodiment; FIG. 4 is a left side elevation view of the first embodiment; FIG. 5 is a right side elevation view of the first embodiment; FIG. 6 is a top plan view of the first embodiment; FIG. 7 is a bottom plan view of the first embodiment; FIG. 8 is a front perspective view of the first embodiment showing a front latch in an unlatched position; FIG. 9 is a front perspective view of a second embodiment of a thermoformed container showing the new design; FIG. 10 is a front side elevation view of the second embodiment; FIG. 11 is a rear side elevation view of the second embodiment; FIG. 12 is a left side elevation view of the second embodiment; FIG. 13 is a right side elevation view of the second embodiment; FIG. 14 is a top plan view of the second embodiment; FIG. 15 is a bottom plan view of the second embodiment; and, FIG. 16 is a front perspective view of the second embodiment showing a front latch in an unlatched position.

1 Claim, 16 Drawing Sheets

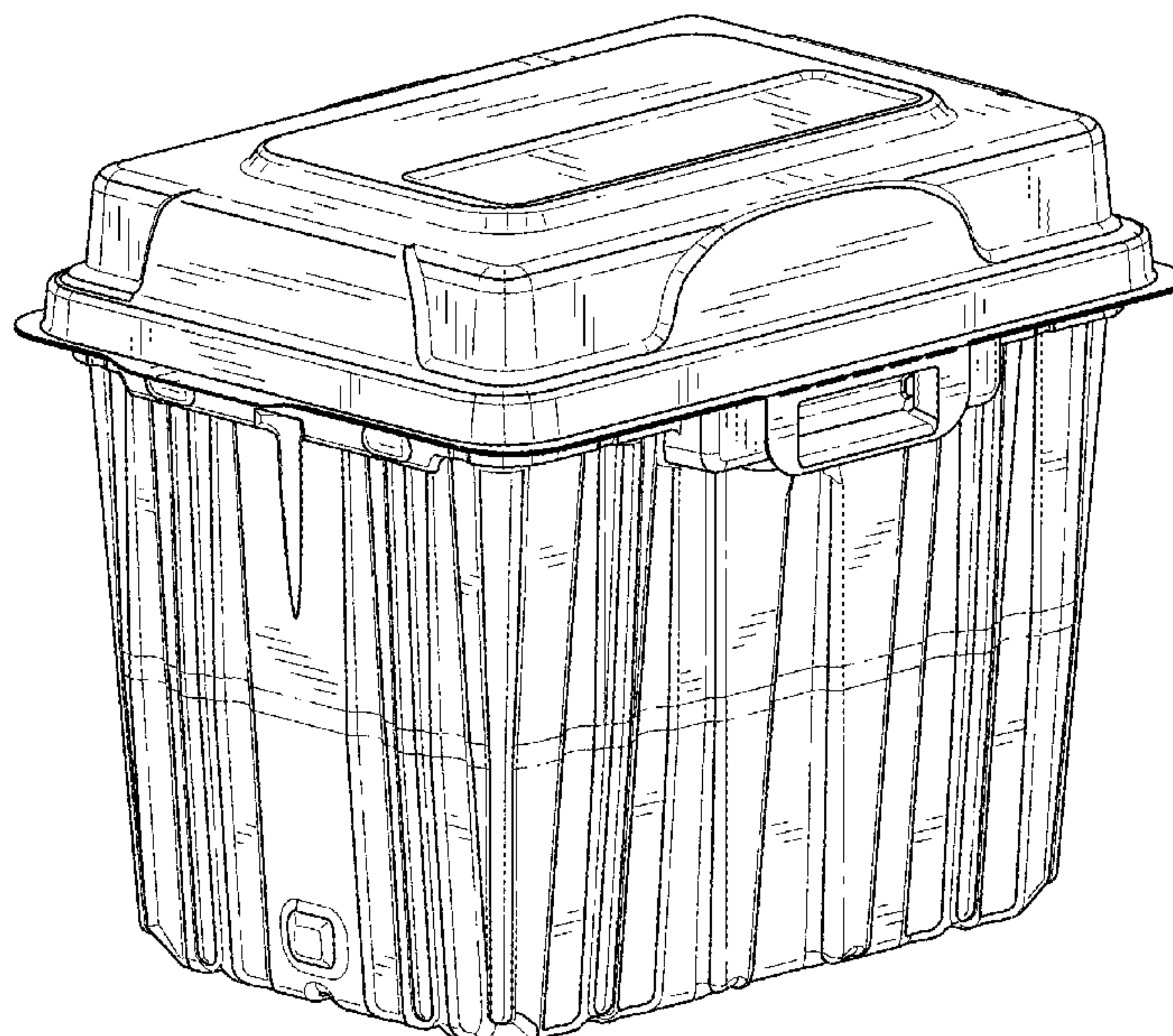

(56)

References Cited

U.S. PATENT DOCUMENTS

5,642,816 A 7/1997 Kelly et al.
 6,019,225 A 2/2000 Kalmakis et al.
 6,098,819 A 8/2000 Link
 6,286,678 B1 9/2001 Petrek
 6,609,633 B1* 8/2003 Dyble B65D 43/164
 8,863,975 B2* 10/2014 McCanless B65D 41/02
 220/4.23
 9,352,324 B2 5/2016 Rethwisch et al.
 9,617,036 B2 4/2017 Baker
 D806,483 S* 1/2018 Stanford D7/605
 D893,025 S* 8/2020 Joyce D24/131
 D907,445 S* 1/2021 Nichols D7/605
 D919,116 S* 5/2021 Motadel D24/227
 2004/0155048 A1* 8/2004 Aiken B65D 21/0219
 220/801
 2009/0114646 A1* 5/2009 Whalen A45C 13/123
 220/4.21
 2010/0108556 A1* 5/2010 Claffy B65D 25/04
 206/508
 2014/0234182 A1* 8/2014 Motadel B01L 9/543
 422/526
 2015/0367349 A1 12/2015 Leinonen et al.

2016/0000269 A1* 1/2016 Van Puijenbroek ... B65D 59/04
 426/124
 2017/0029173 A1* 2/2017 Baker B65D 25/04
 2017/0210522 A1* 7/2017 Baker B65D 25/04
 2017/0217637 A1 8/2017 Auerbach
 2017/0275058 A1* 9/2017 Bischoff B65D 43/14
 2017/0275059 A1* 9/2017 Lotfi B65D 51/245
 2017/0275075 A1* 9/2017 Bamonte B65D 21/0219
 2017/0280903 A1* 10/2017 Gebhardt B65D 21/0215
 2017/0305632 A1* 10/2017 Brown B65D 25/18
 2019/0275528 A1 9/2019 Rethwisch et al.

OTHER PUBLICATIONS

Brand® ULR™ Ultra Low Retention Pipette Tips. Online, published date unknown. Retrieved on Jun. 25, 2021 from URL: <https://www.brandtech.com/product/ultra-low-retention-tips/>.
 Filter pipette tip ECO Rack GripTips™. Online, published date unknown. Retrieved on Jun. 25, 2021 from URL: <https://www.medicalexpo.com/prod/integra-biosciences-ag/product-80406-945998.html>.
 Terrarack Data Sheet, Rainin Instrument, LLC, Mar. 2015.
 Liquid Handling Brochure, Consumables Peak Perfection, Eppendorf AG, 2018.

* cited by examiner

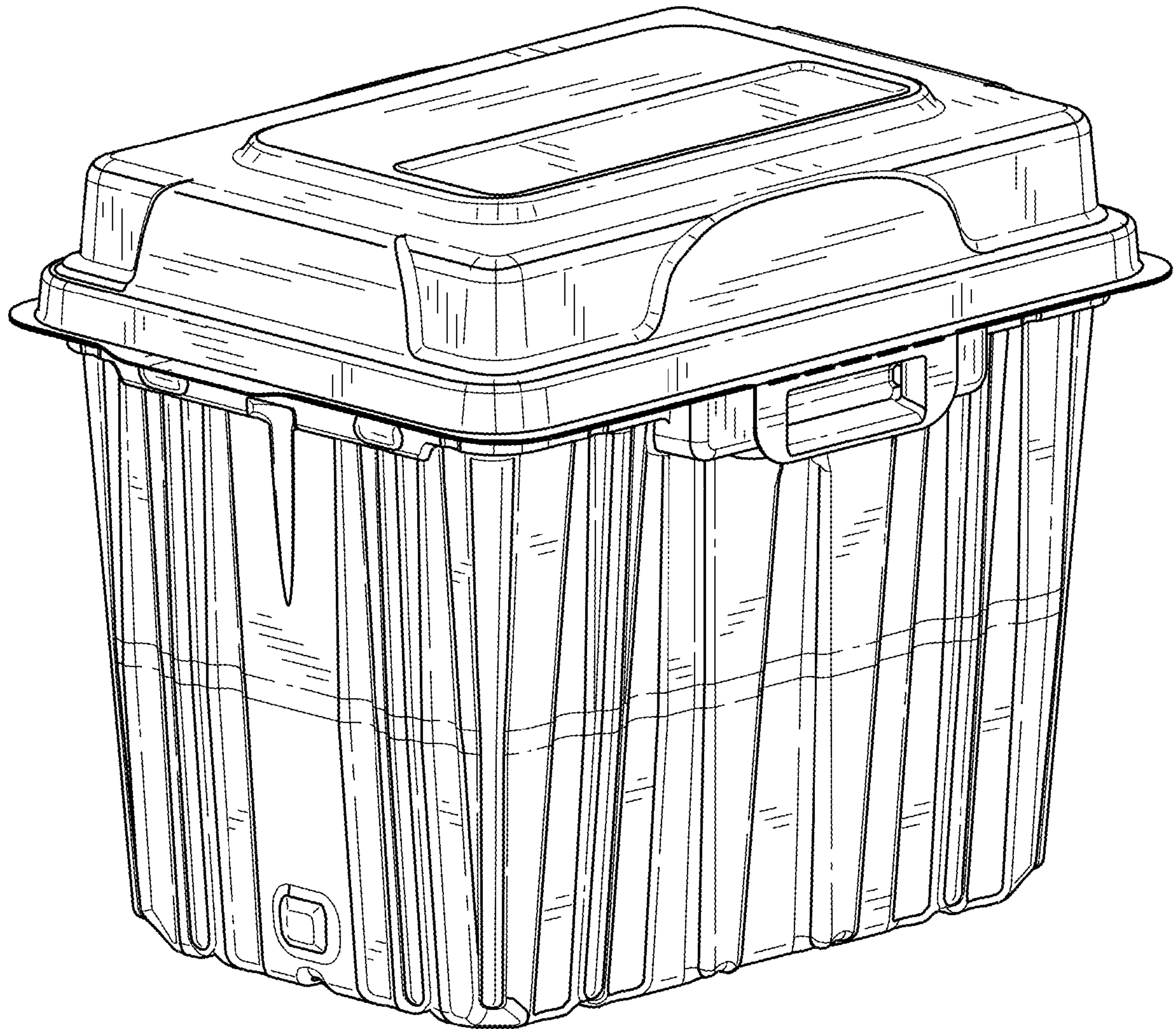

FIG. 1

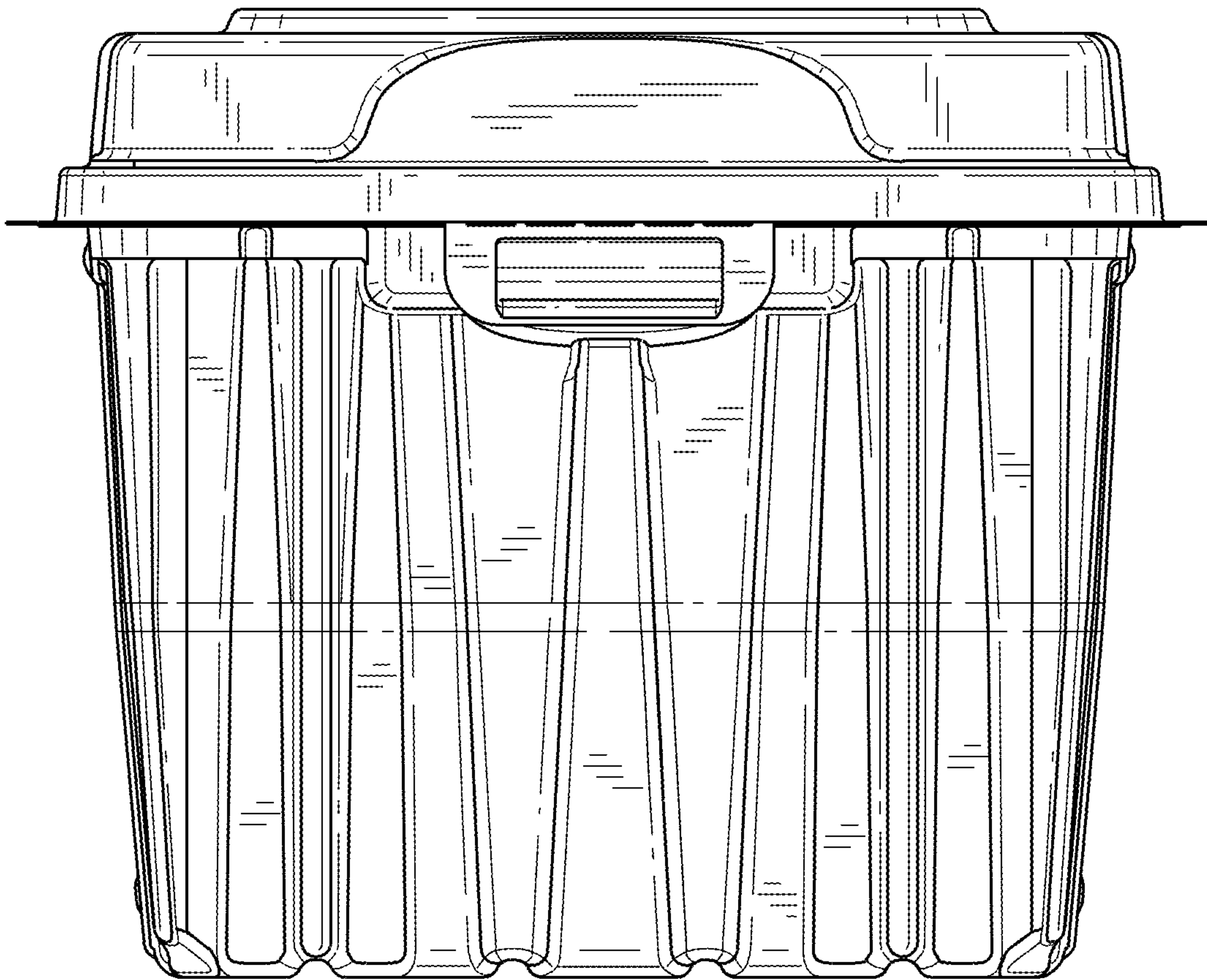

FIG. 2

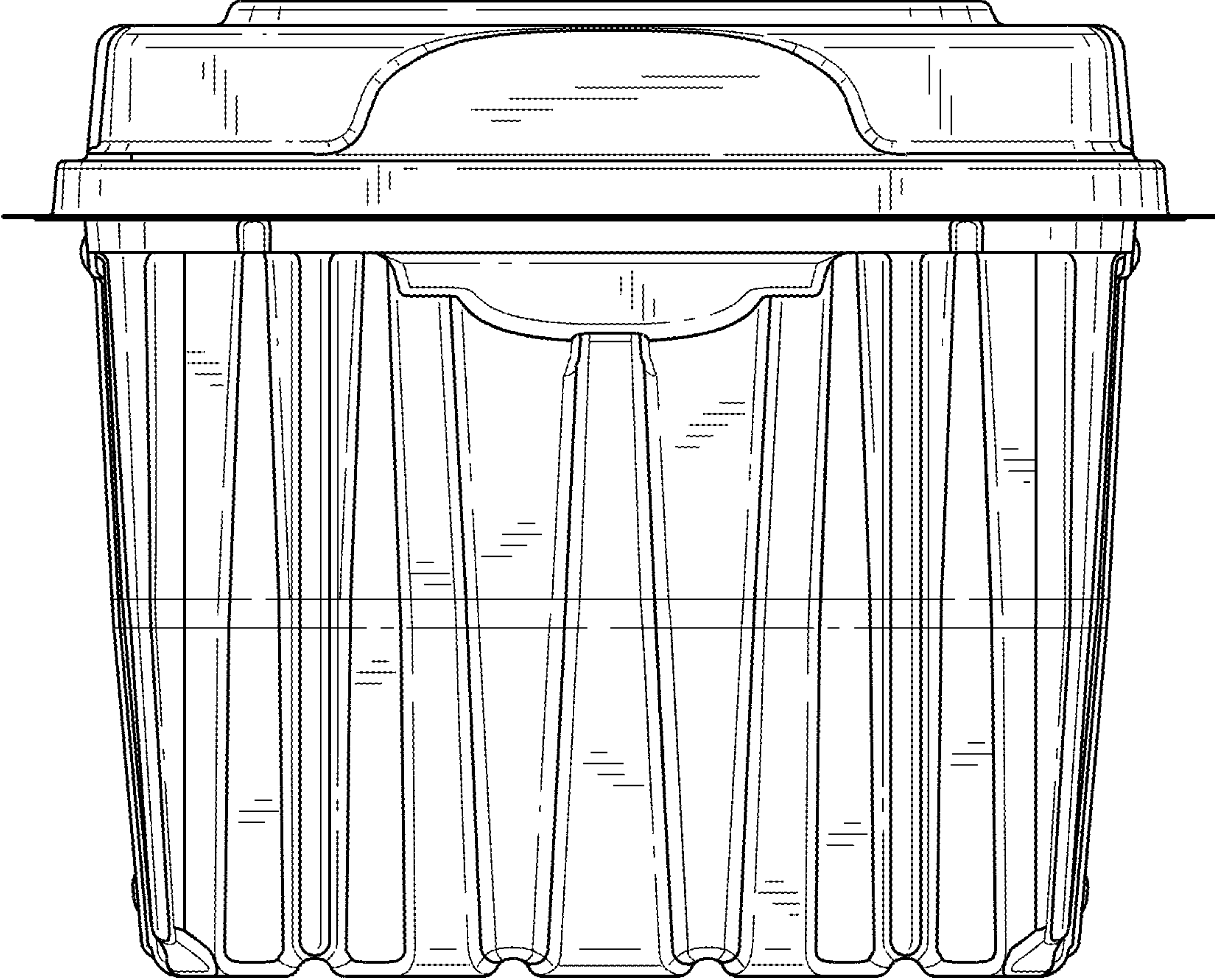

FIG. 3

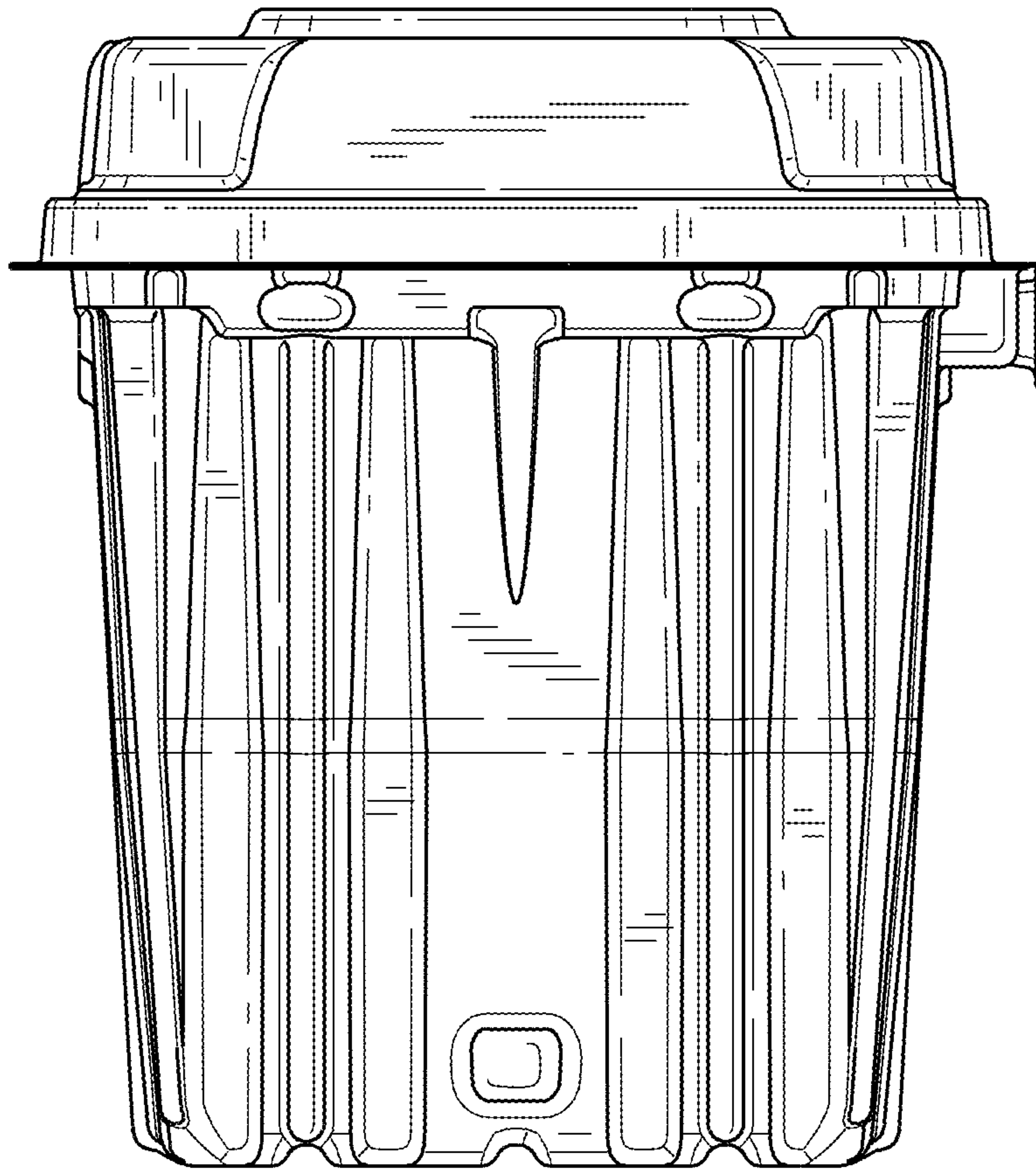

FIG. 4

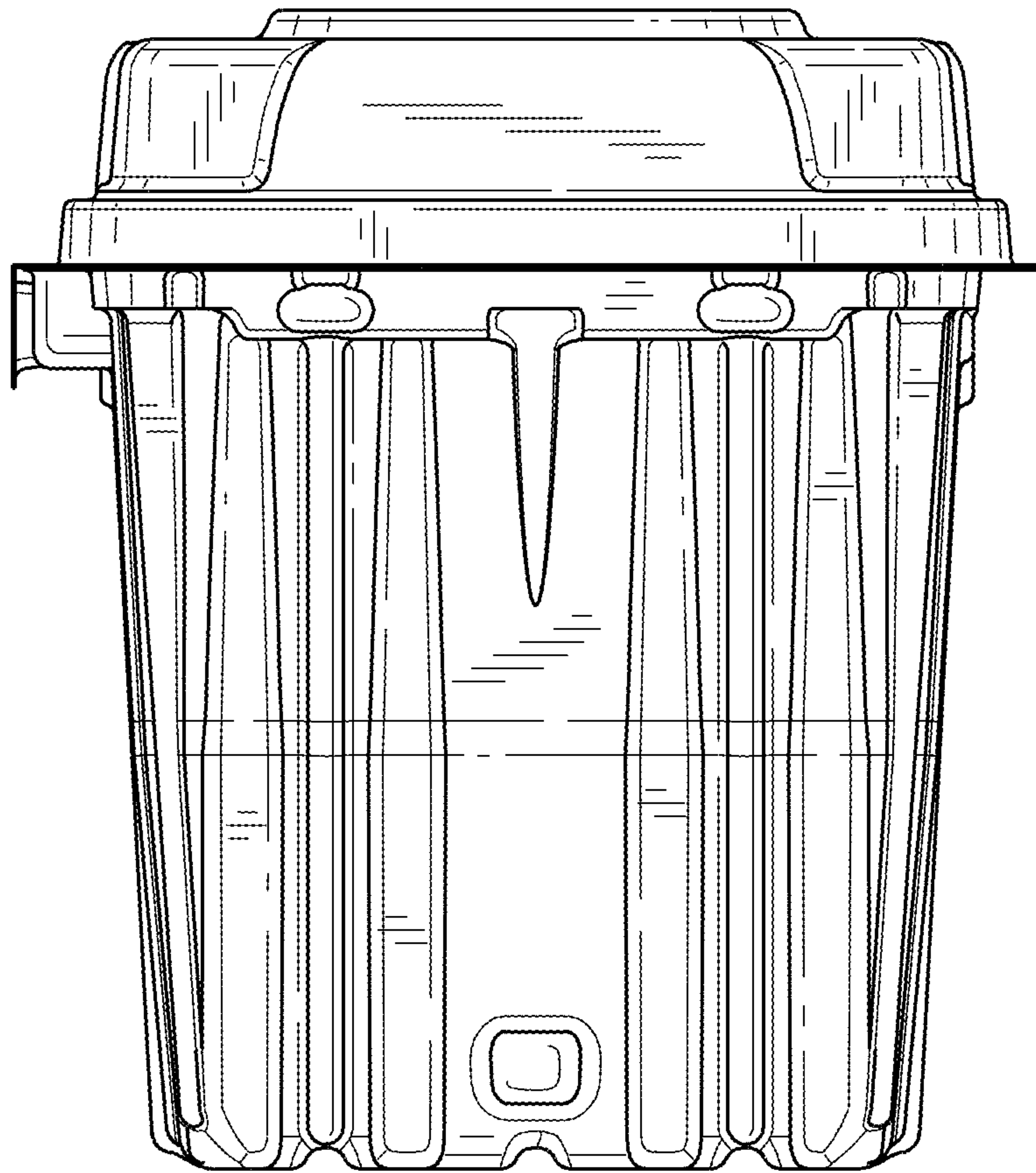

FIG. 5

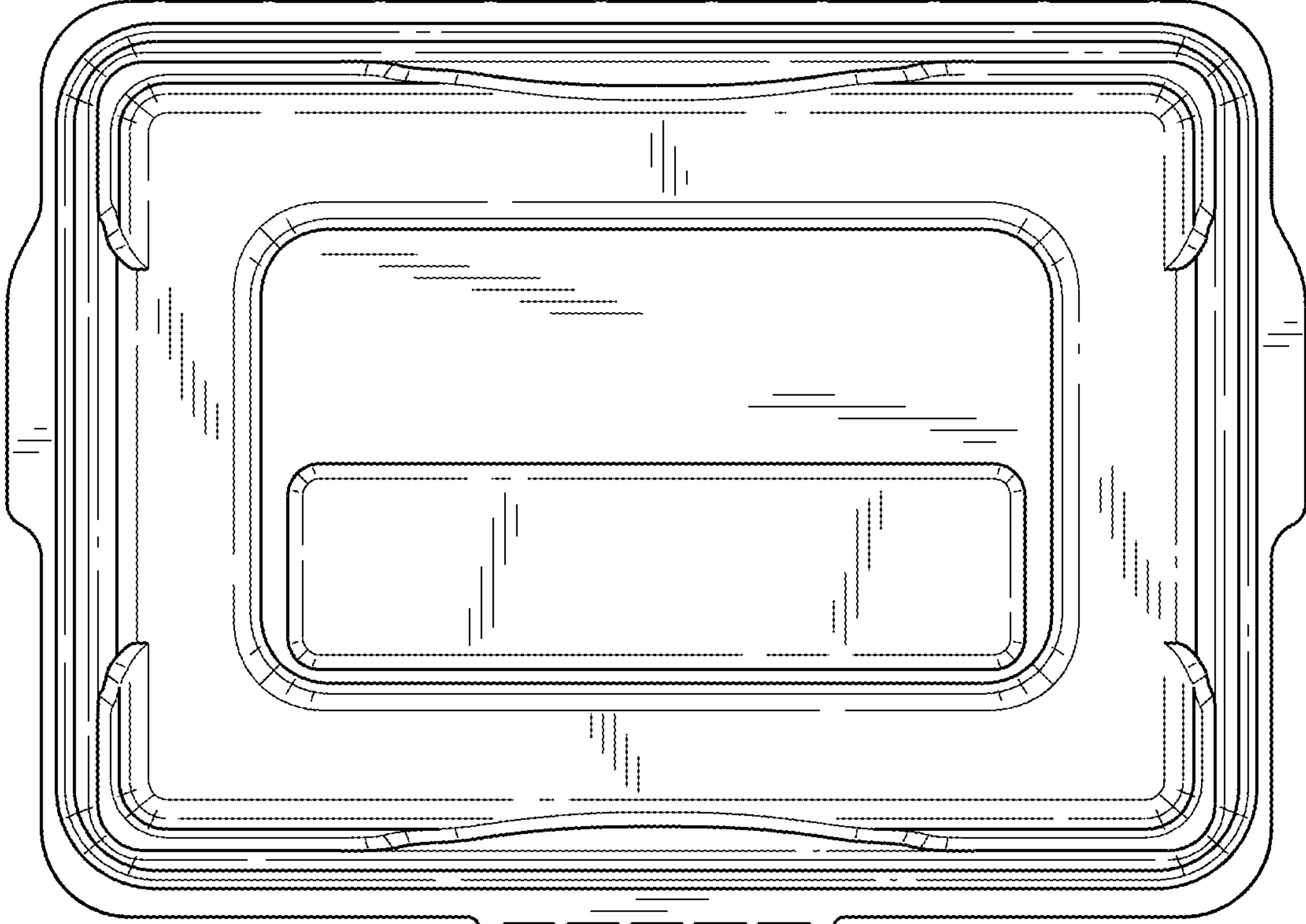

FIG. 6

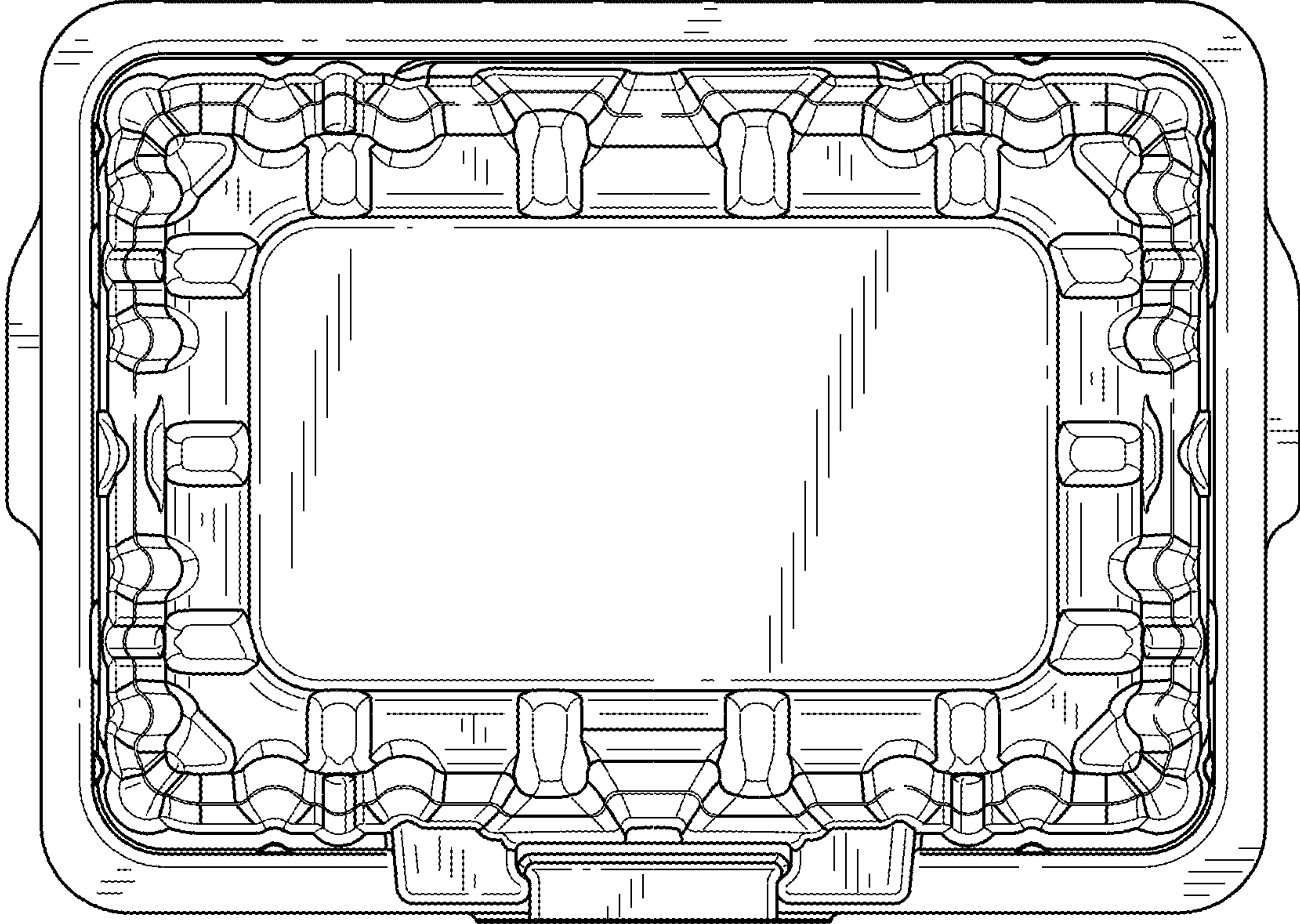

FIG. 7

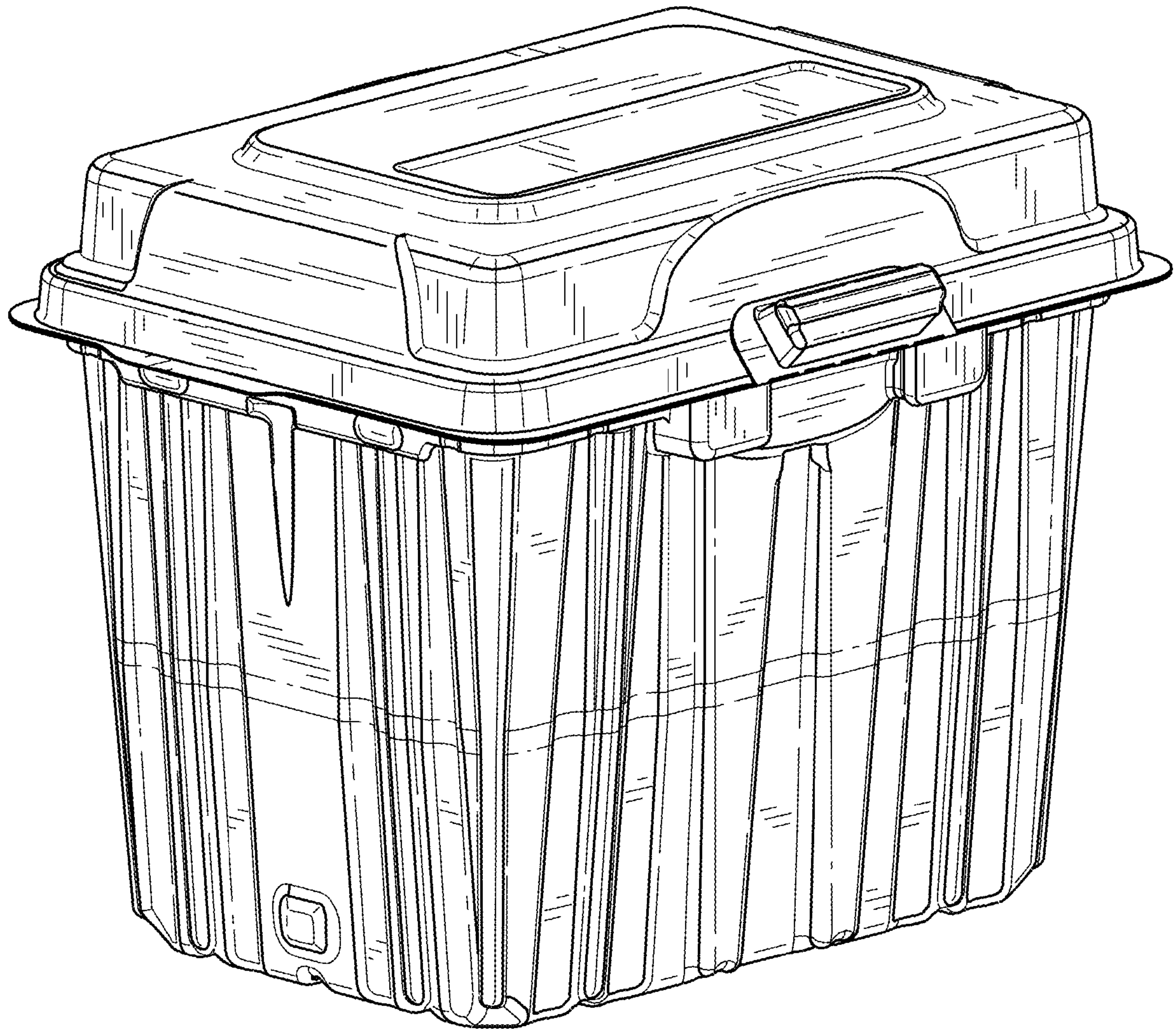

FIG. 8

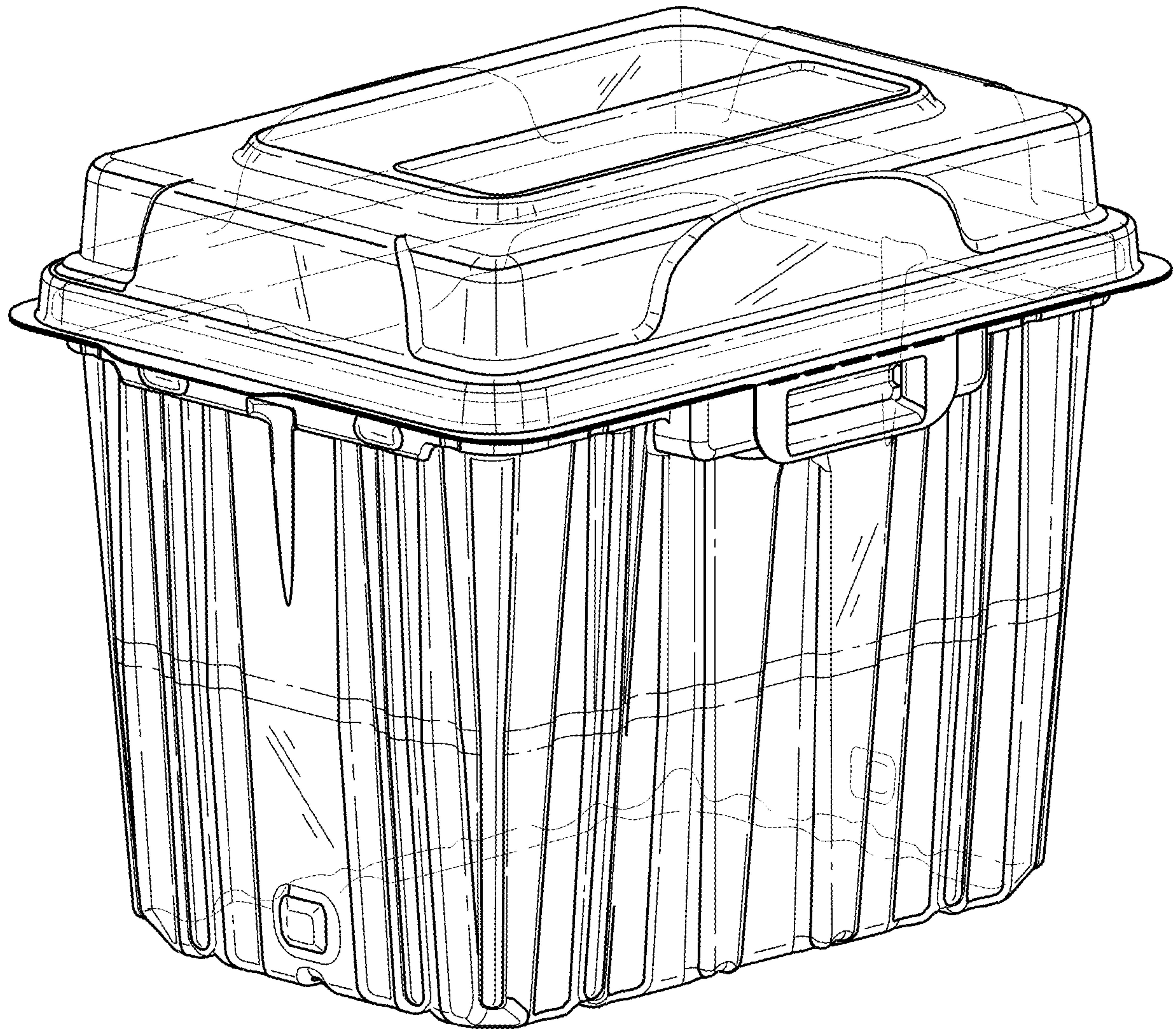

FIG. 9

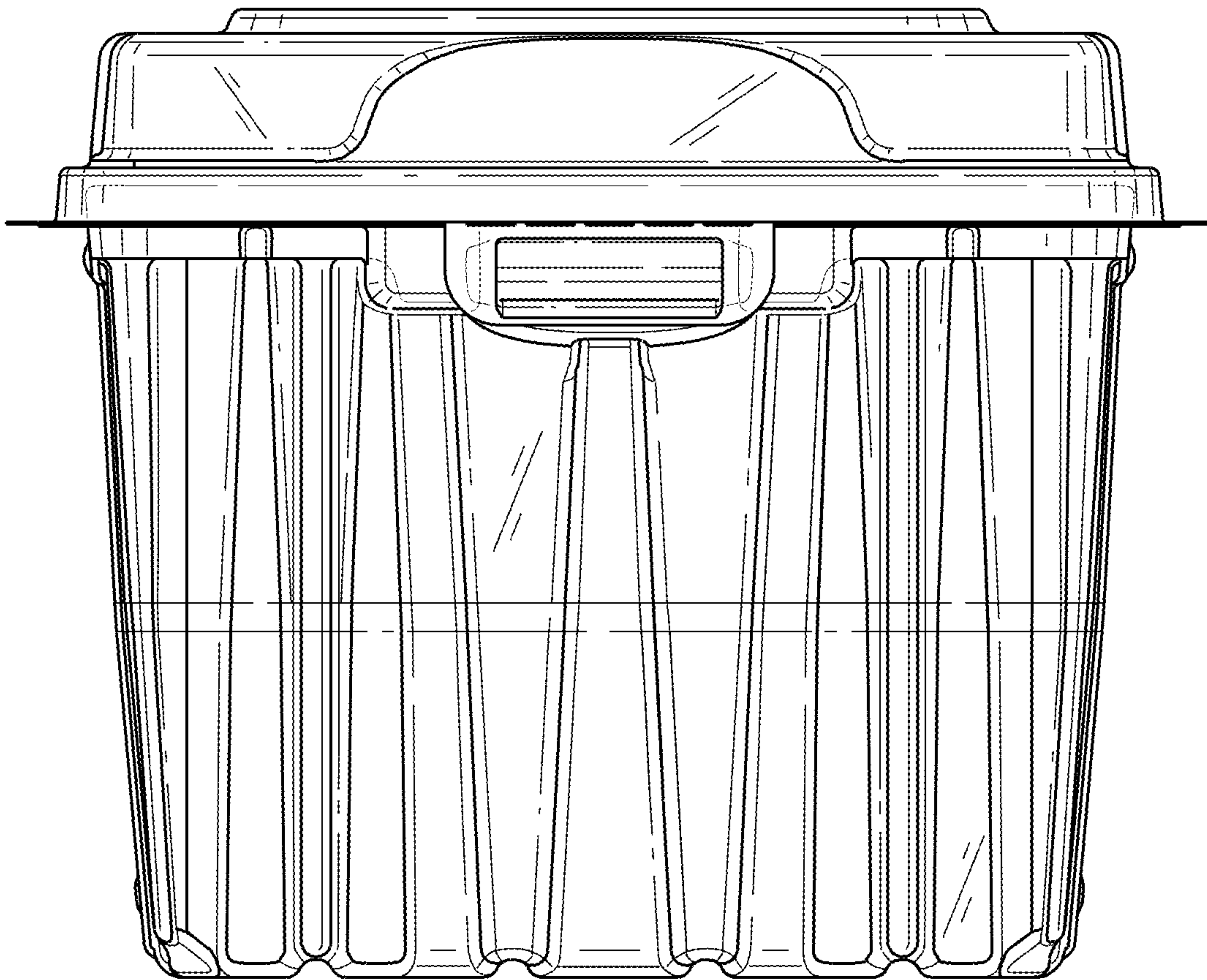

FIG. 10

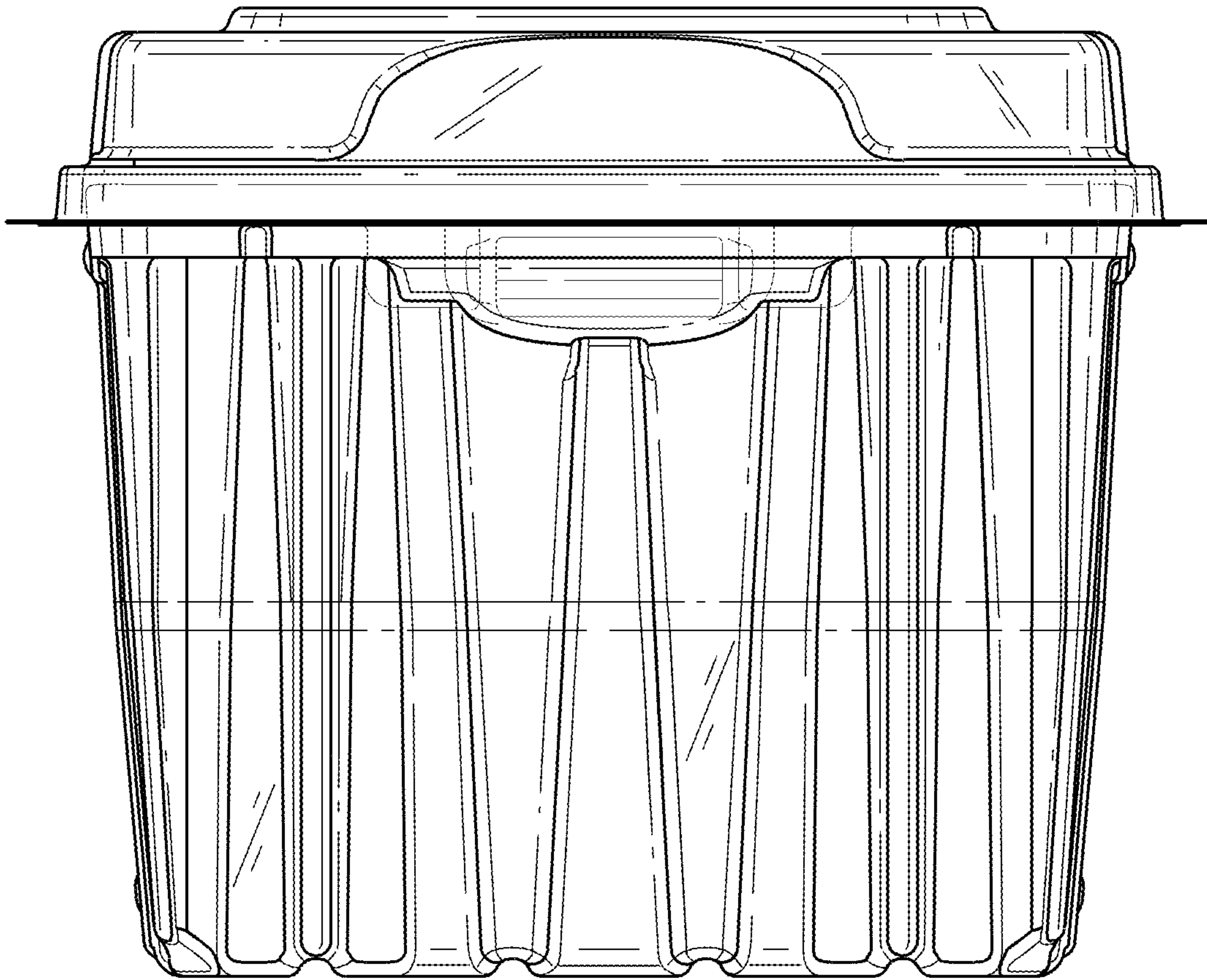

FIG. 11

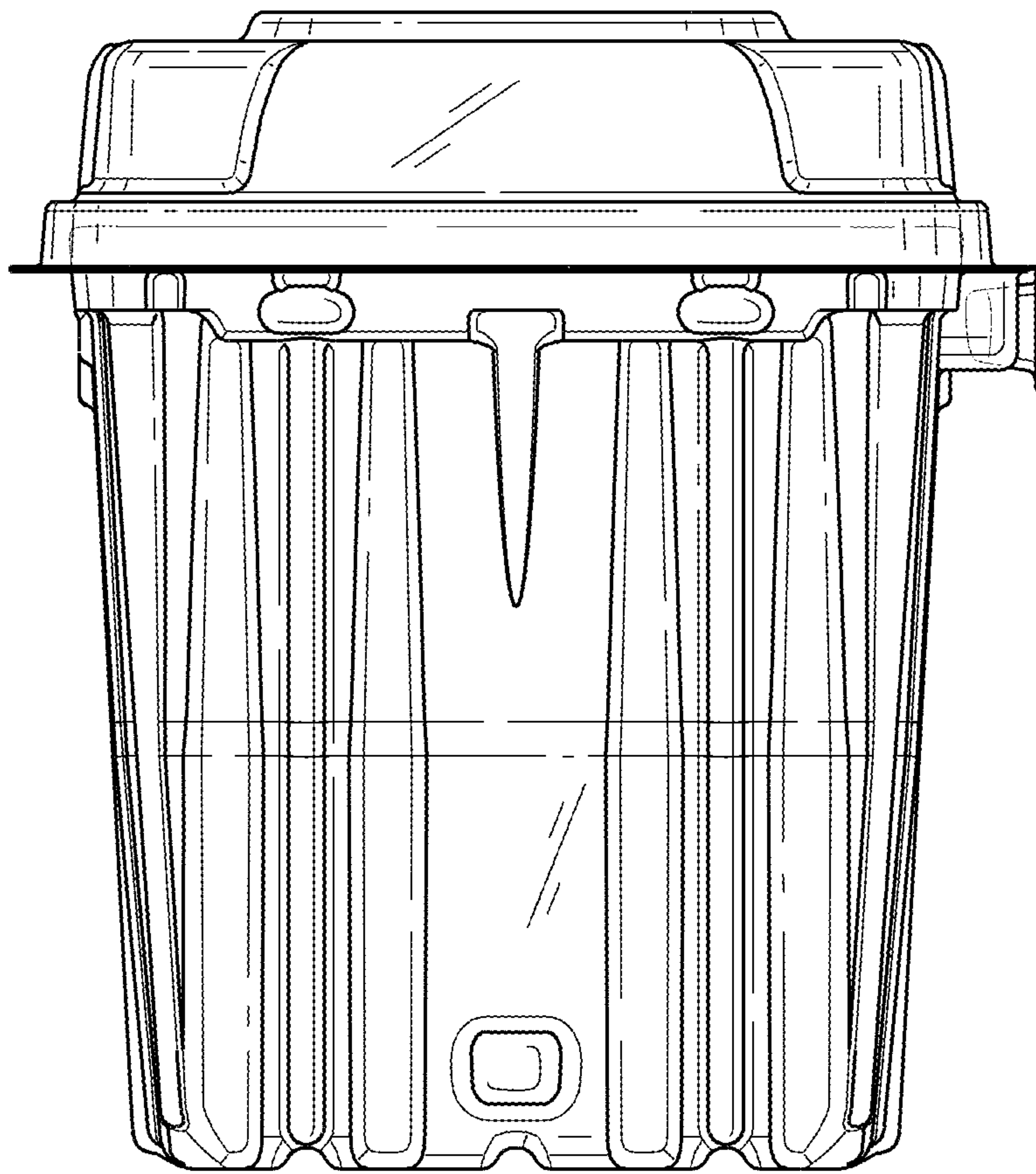

FIG. 12

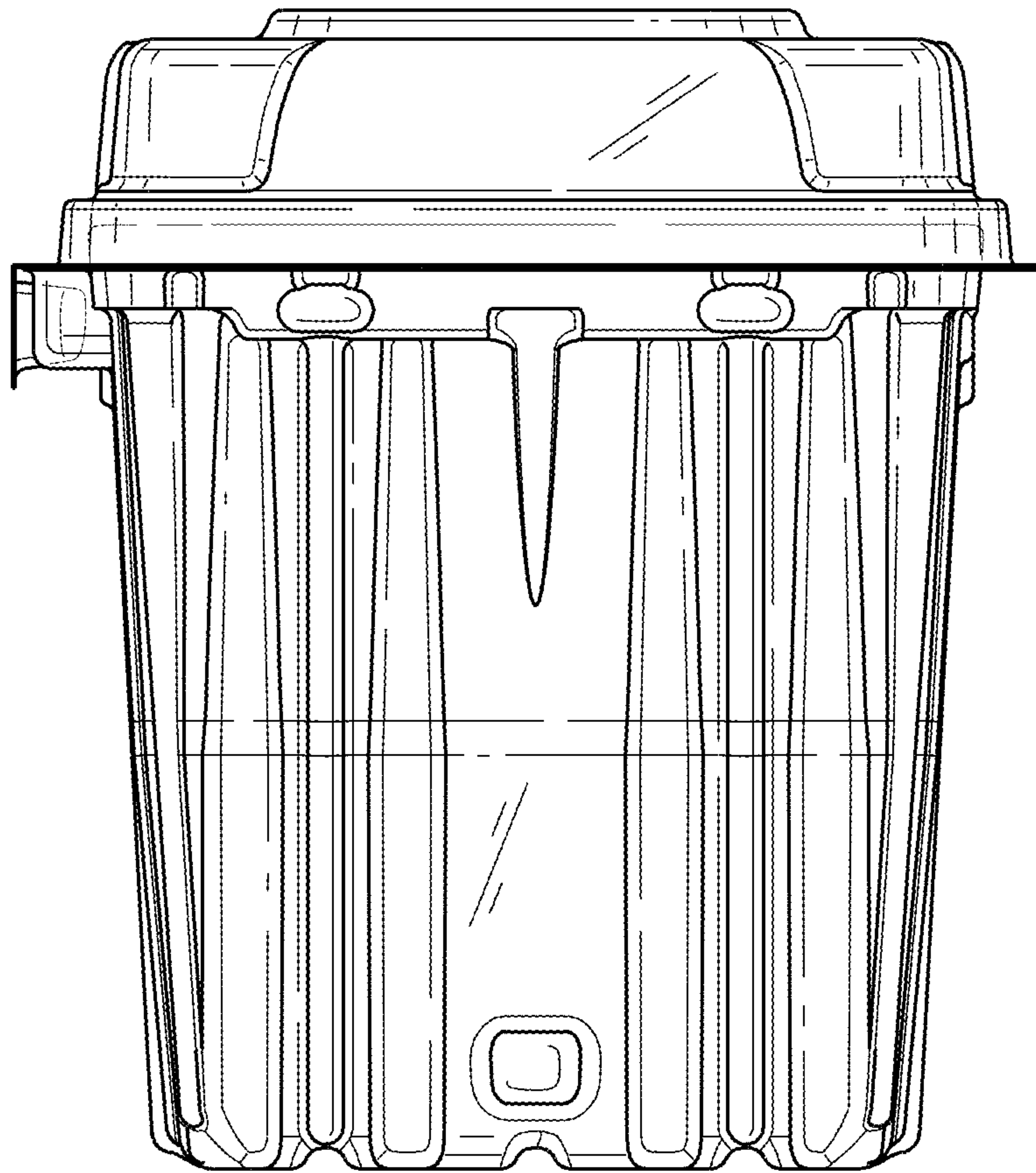

FIG. 13

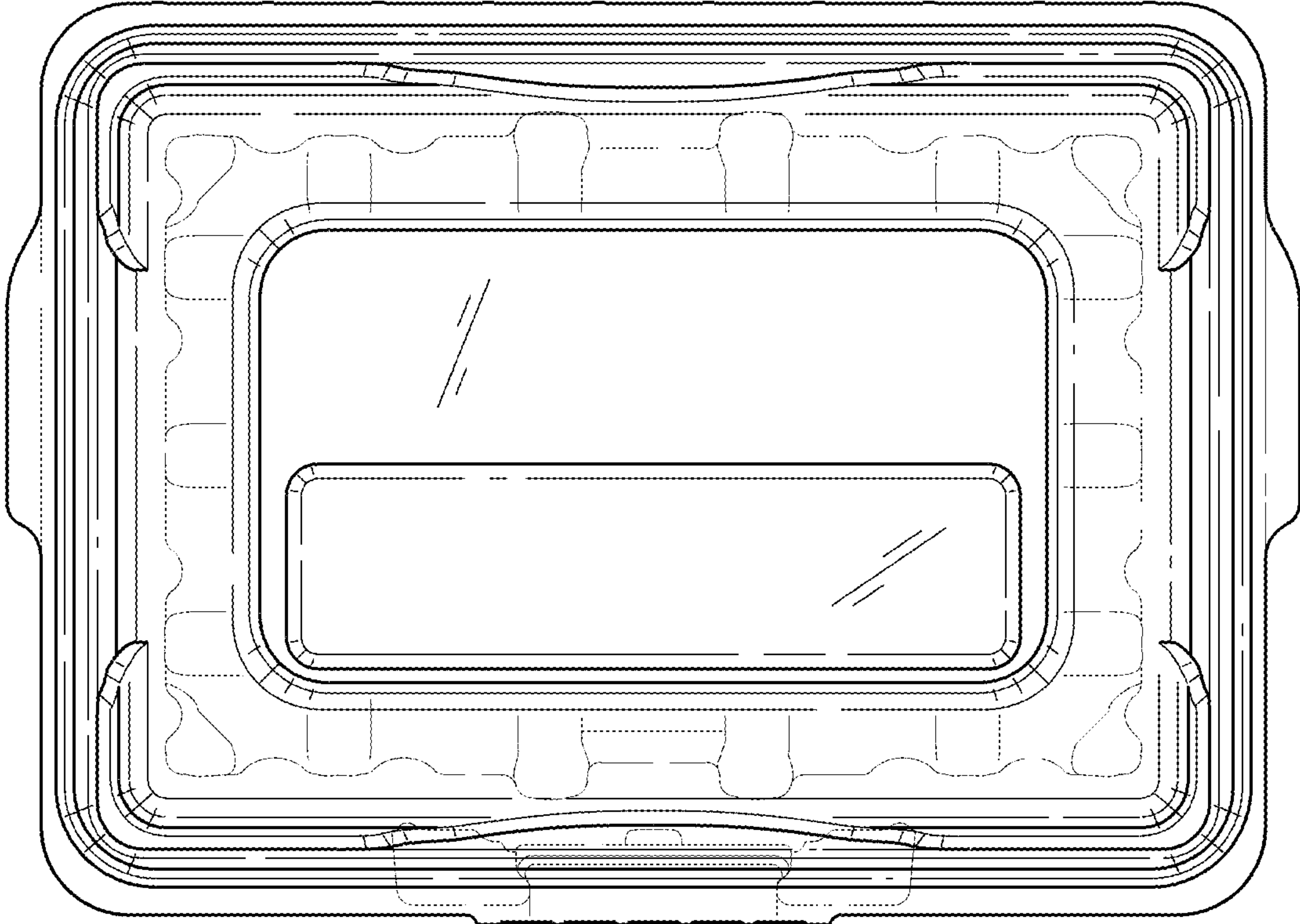

FIG. 14

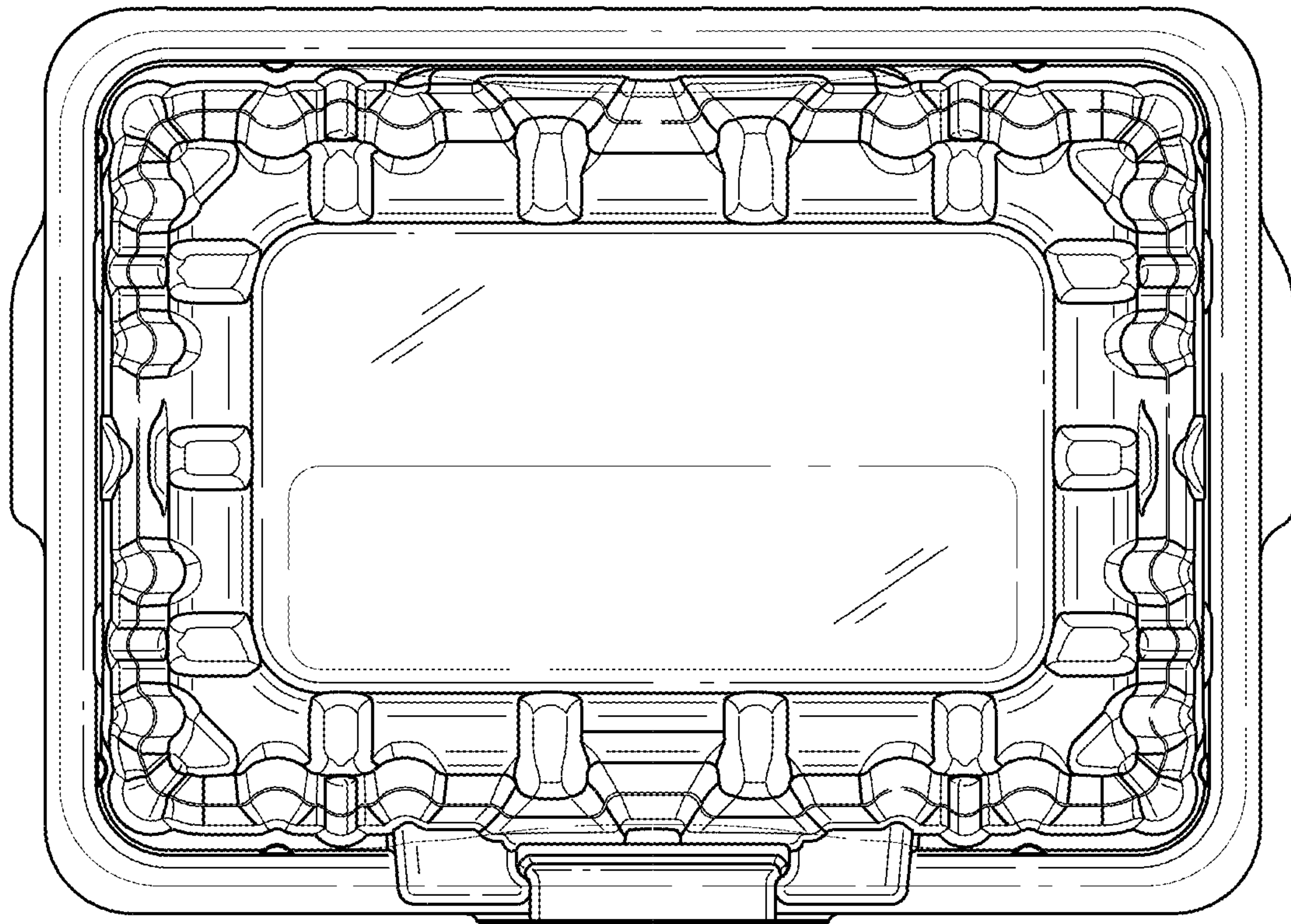

FIG. 15

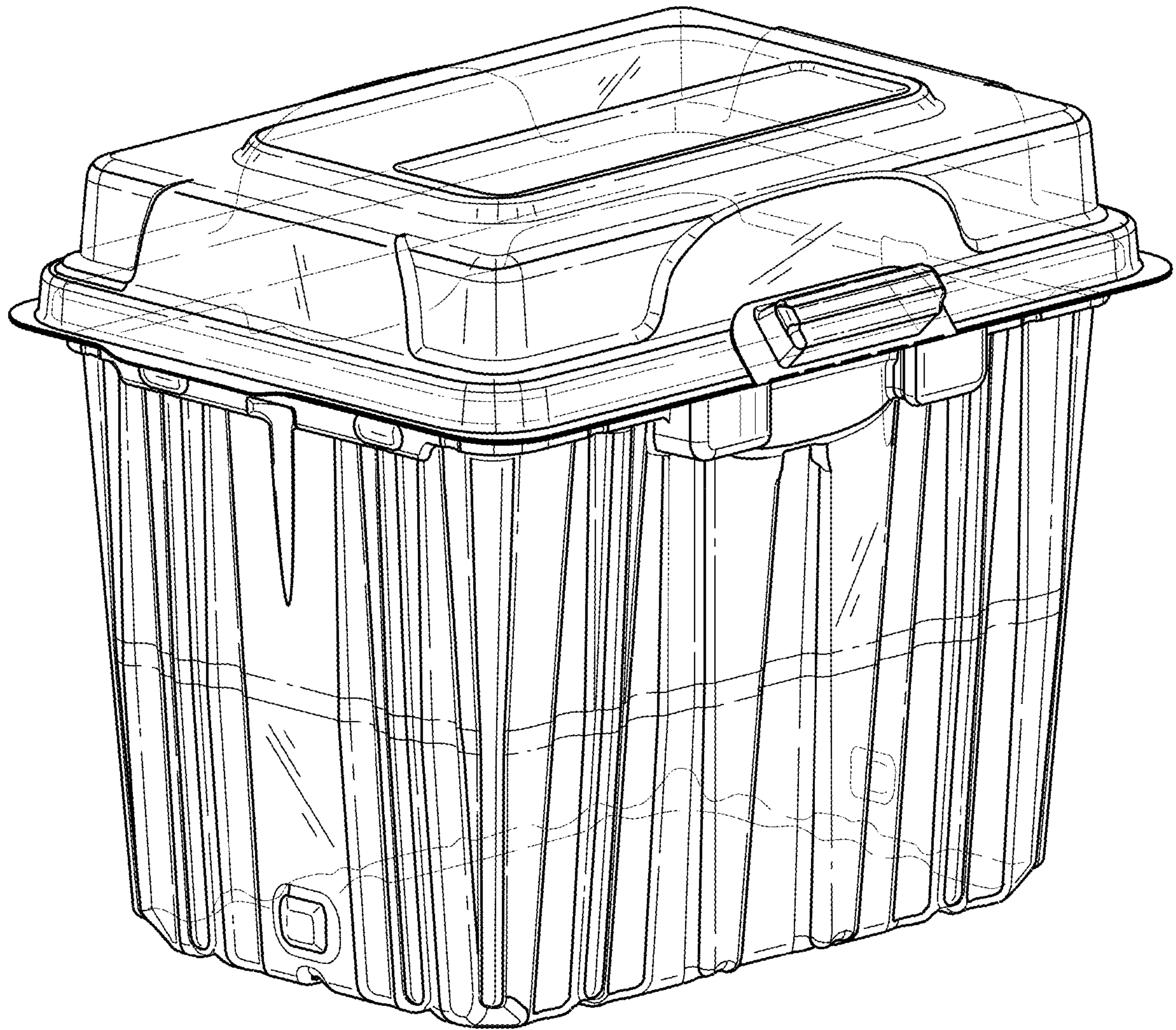

FIG. 16