



US00D954927S

(12) **United States Design Patent** (10) **Patent No.:** **US D954,927 S**
Lee (45) **Date of Patent:** **** Jun. 14, 2022**

(54) **PORTABLE DIFFUSER**
(71) Applicant: **Bloomy Lotus Ltd**, Hong Kong (HK)
(72) Inventor: **Leander Lee**, Hong Kong (HK)
(73) Assignee: **Bloomy Lotus Ltd**, Hong Kong (HK)
(**) Term: **15 Years**
(21) Appl. No.: **29/752,680**
(22) Filed: **Sep. 28, 2020**

(30) **Foreign Application Priority Data**
Apr. 3, 2020 (HK) 2015918.8
(51) **LOC (13) Cl.** **23-04**
(52) **U.S. Cl.**
USPC **D23/366**
(58) **Field of Classification Search**
USPC D23/332, 333, 351-369; D07/300.1, 506;
D14/188, 194, 195, 197, 203.2, 203.6,
D14/204, 209, 213, 215, 216, 221, 228;
D32/30; D11/143, 146
CPC F24F 6/02; F24F 6/12; A61L 9/03; A61L
9/04; A61L 9/05; A61L 9/12; A61L 9/14;
A61L 9/012; A61L 9/015; A61L 9/048;
A61L 9/127; A61L 2209/133; Y10S
261/88; Y10S 261/89; A47G 7/06
See application file for complete search history.

(56) **References Cited**
U.S. PATENT DOCUMENTS
D578,927 S * 10/2008 Brandstatter D11/146
D648,429 S * 11/2011 Choi D23/364

D811,931 S * 3/2018 Yu D23/366
D812,209 S * 3/2018 Farone D23/355
D838,690 S * 1/2019 Cheon D14/216
D886,769 S * 6/2020 Poulheim D14/204
D896,779 S * 9/2020 Lin D14/204
D918,369 S * 5/2021 Jang D23/364
D919,783 S * 5/2021 Jang D23/364
D937,398 S * 11/2021 Jang D23/364

* cited by examiner

Primary Examiner — Gino Colan
Assistant Examiner — David OBrien

(57) **CLAIM**

The ornamental design for a portable diffuser, as shown and described.

DESCRIPTION

FIG. 1 is a front elevational view of a portable diffuser showing my new design;
FIG. 2 is a rear elevational view thereof;
FIG. 3 is a right side view thereof;
FIG. 4 is a left side view thereof;
FIG. 5 is a top plan view thereof;
FIG. 6 is a bottom plan view thereof;
FIG. 7 is a top, front and right side perspective view thereof; and,
FIG. 8 is a bottom, rear and right side perspective view thereof.
The broken lines in FIGS. 5 and 7 illustrate portions of the portable diffuser which form no part of the claimed design.

1 Claim, 8 Drawing Sheets

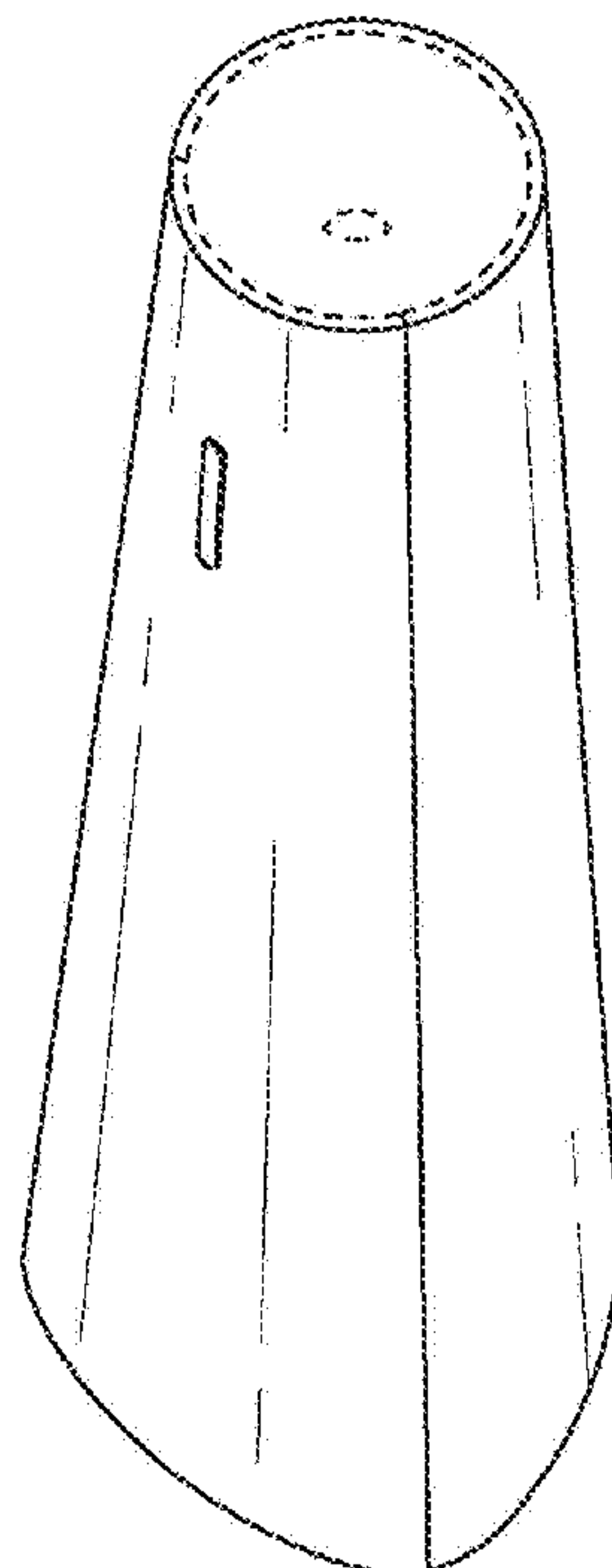

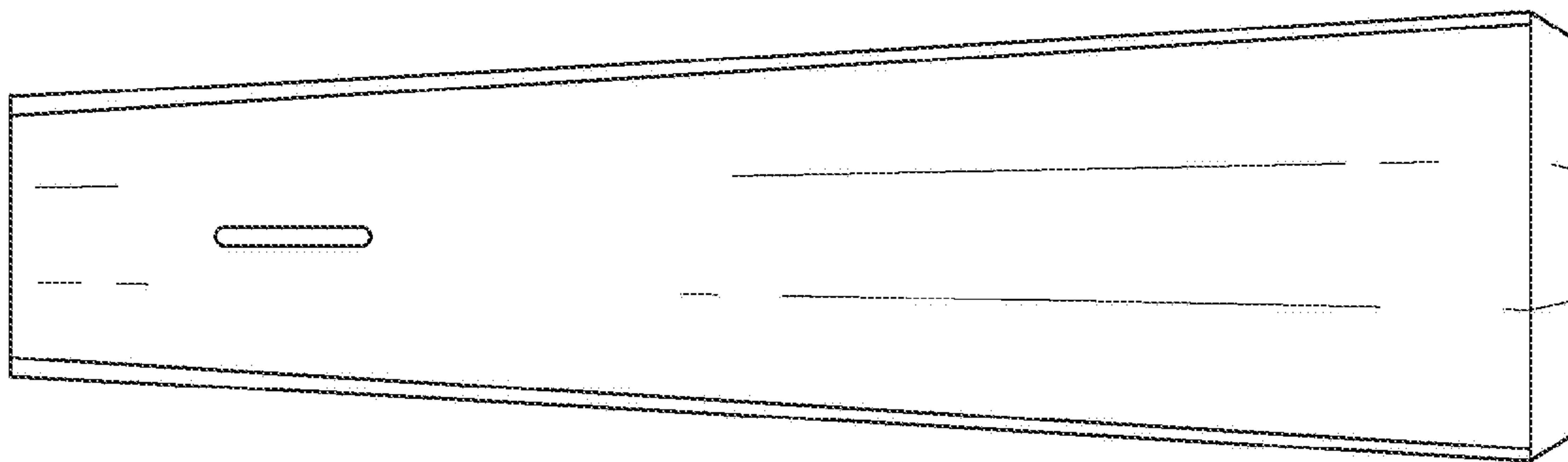

Fig. 1

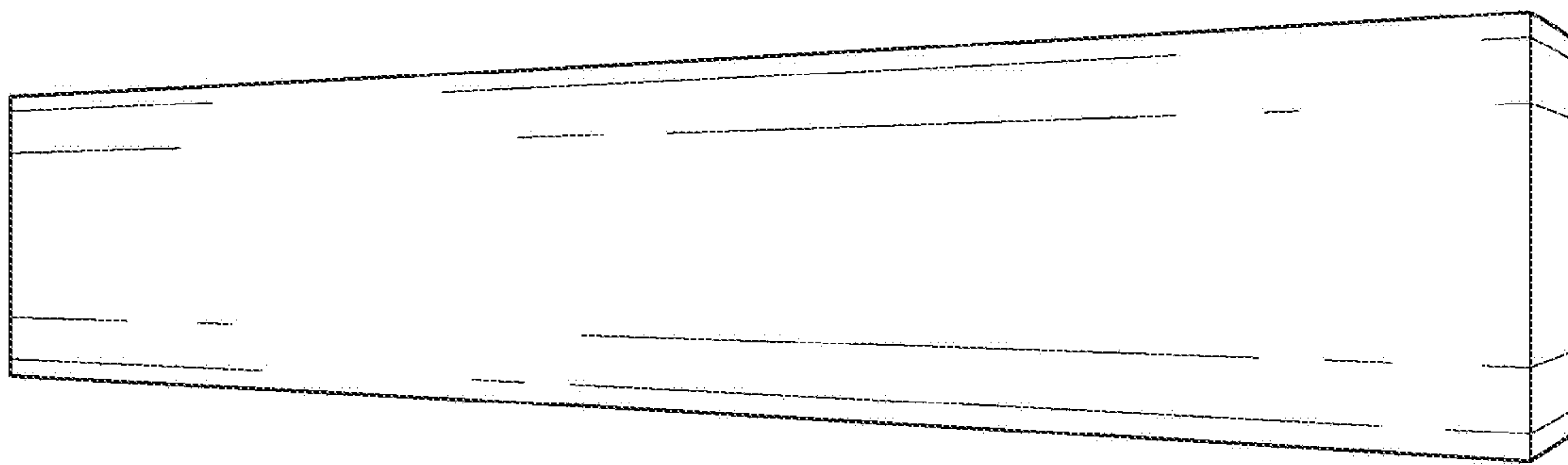

Fig. 2

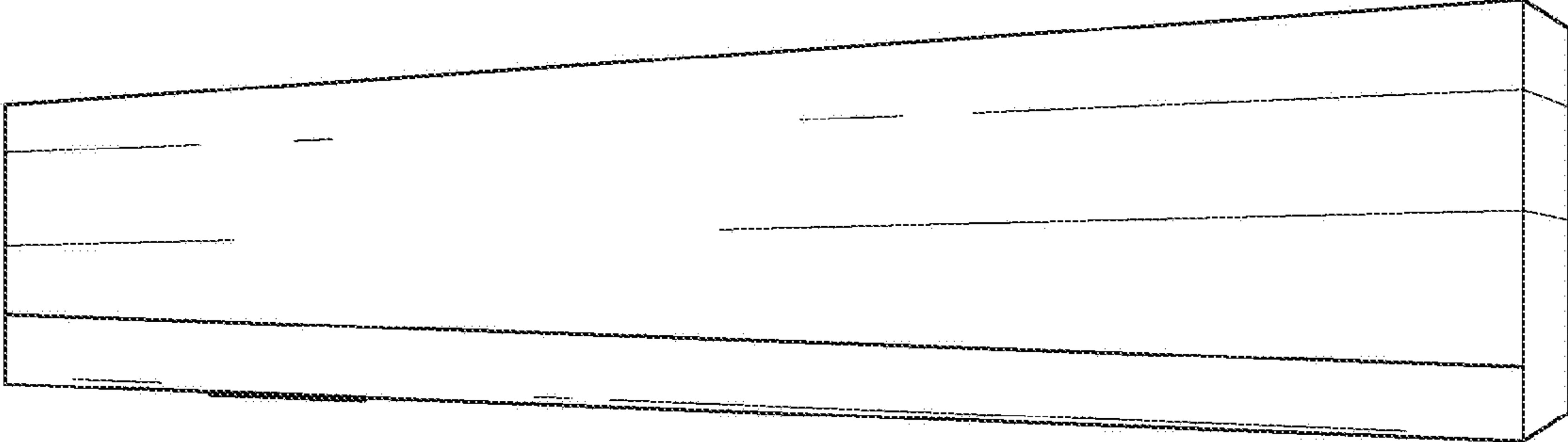

Fig. 3

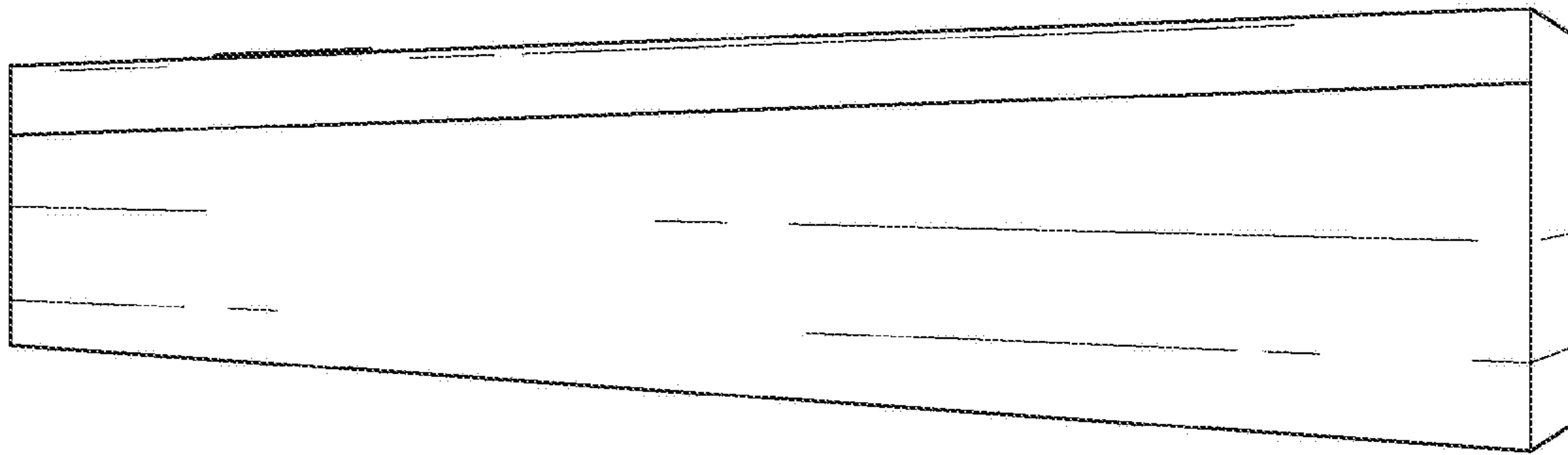

Fig. 4

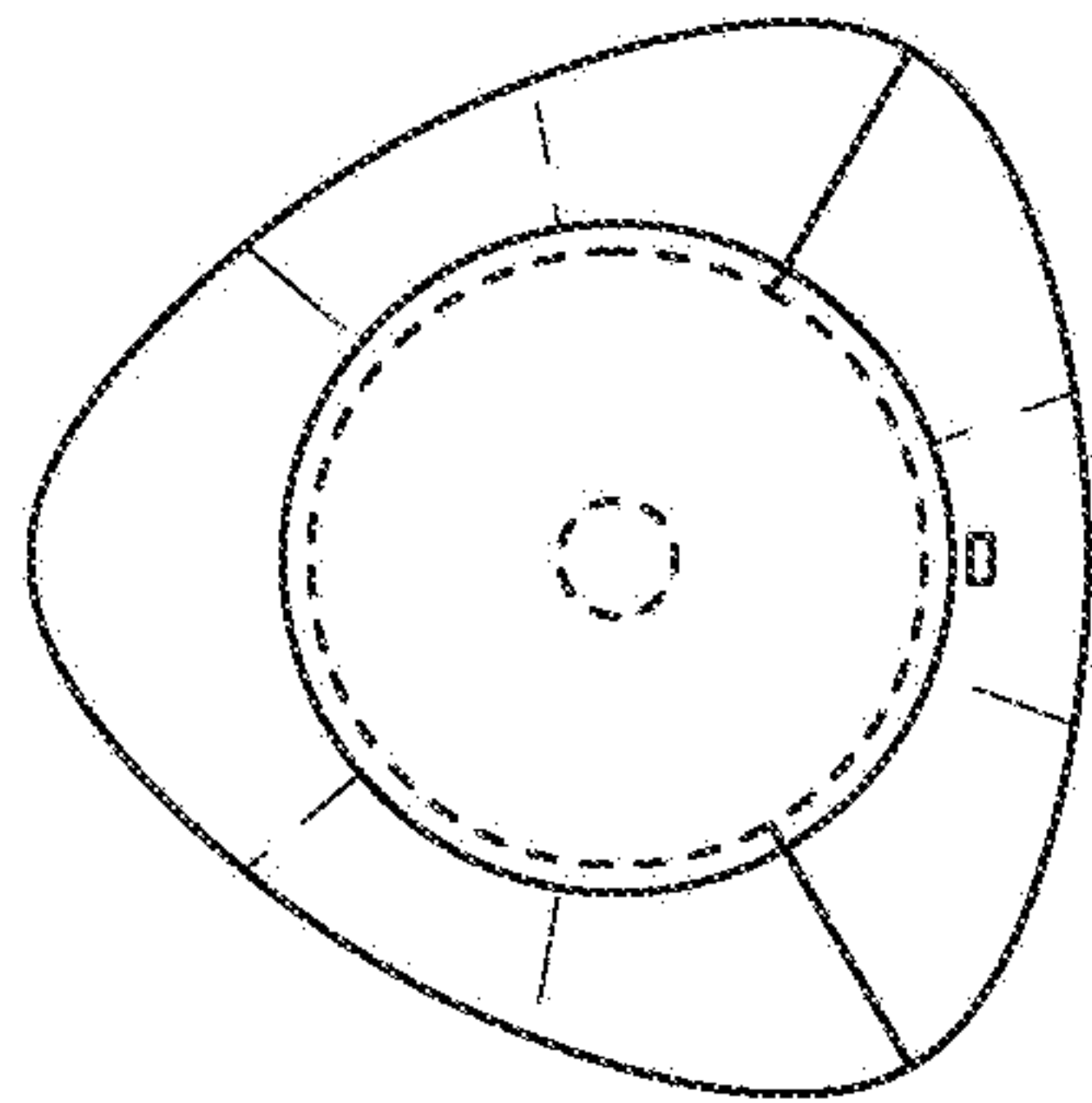

Fig. 5

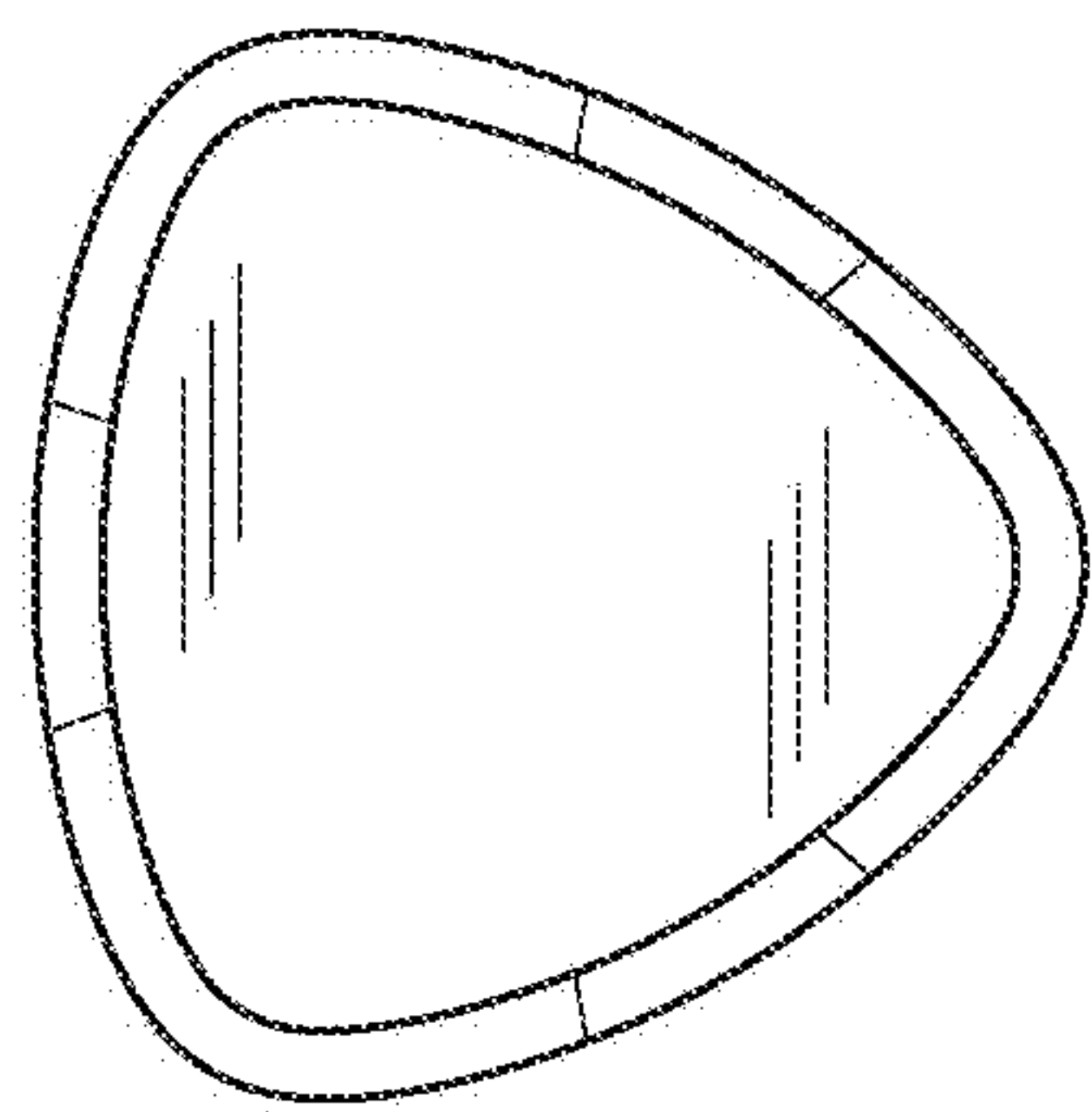

Fig. 6

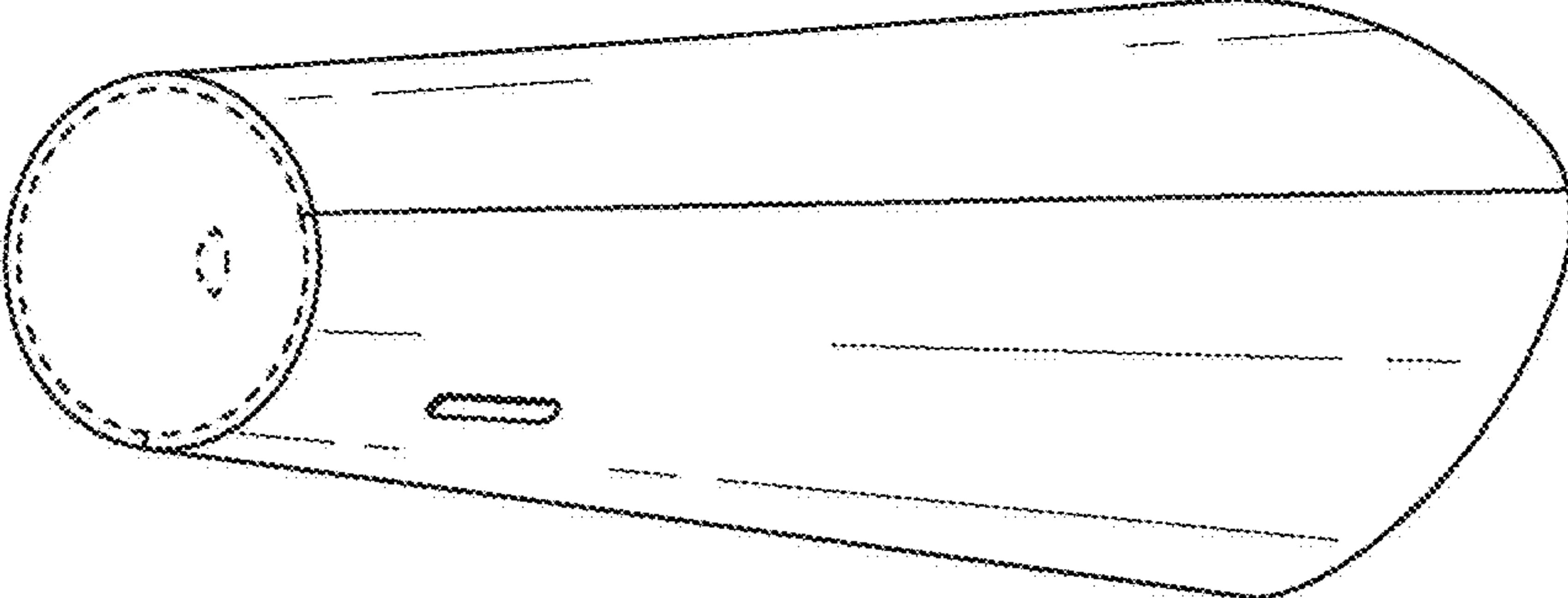

Fig. 7

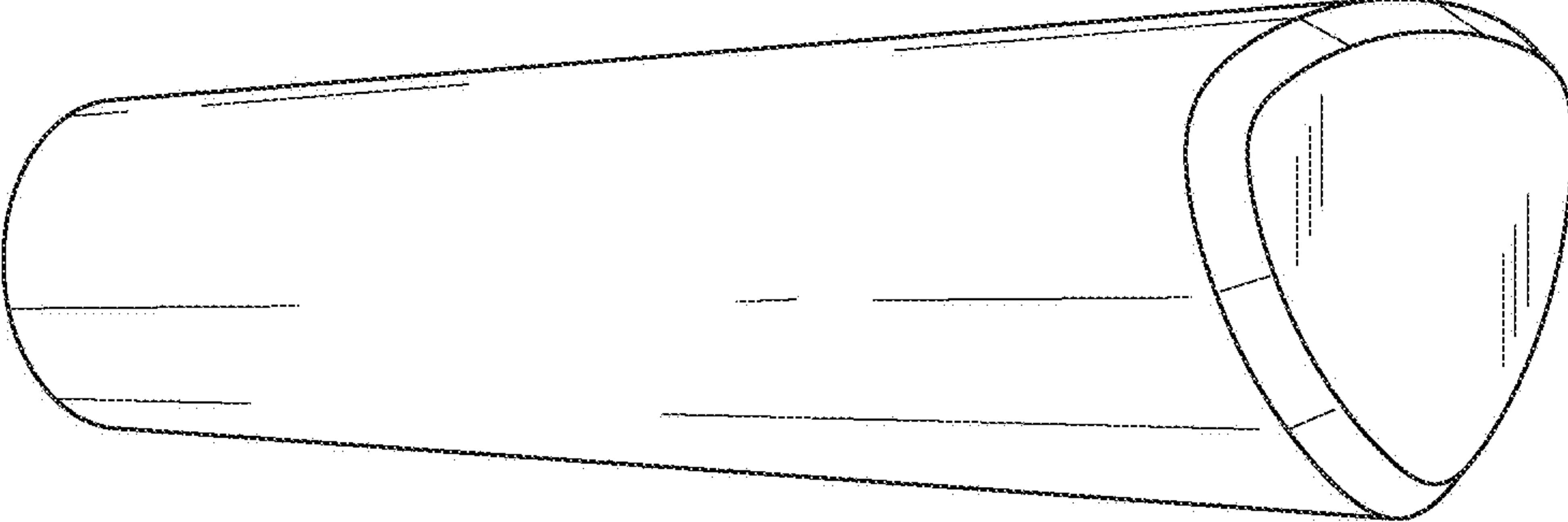

Fig. 8