



US00D954910S

(12) **United States Design Patent**  
**Witt et al.**

(10) **Patent No.:** **US D954,910 S**  
(45) **Date of Patent:** **\*\* Jun. 14, 2022**

(54) **SHOWER DIVERTER TRIM**  
(71) Applicant: **HANSGROHE SE**, Schiltach (DE)  
(72) Inventors: **Alvaro Witt**, Stuttgart (DE); **Andreas Diefenbach**, Ludwigsburg-Ossweil (DE)  
(73) Assignee: **Hansgrohe SE**, Schiltach (DE)  
(\*\*) Term: **15 Years**

D580,525 S	11/2008	Citterio	
D677,758 S *	3/2013	Mendoza	D23/252
D718,421 S *	11/2014	Smith	D23/252
D718,839 S *	12/2014	Garland	D23/252
D787,639 S *	5/2017	Slothower	D23/252
D797,896 S *	9/2017	Eads	D23/254
D815,511 S *	4/2018	Groleski	D8/350
D827,102 S *	8/2018	Spangler	D23/254
D936,798 S *	11/2021	Lazarini	D23/254
D936,799 S *	11/2021	Lazarini	D23/254

\* cited by examiner

(21) Appl. No.: **29/757,433**  
(22) Filed: **Nov. 5, 2020**

*Primary Examiner* — Robert A Delehanty  
(74) *Attorney, Agent, or Firm* — Lora J. Graentzdoerffer

(30) **Foreign Application Priority Data**

May 11, 2020 (EM) ..... 007880810-0016

(51) **LOC (13) Cl.** ..... **23-01**

(52) **U.S. Cl.**  
USPC ..... **D23/254**

(58) **Field of Classification Search**  
USPC ..... D23/238–243, 250, 252, 254;  
D8/307–308, 350  
CPC ..... Y10T 137/9464  
See application file for complete search history.

(57) **CLAIM**

The ornamental design for a shower diverter trim, as shown and described.

**DESCRIPTION**

FIG. 1 is a perspective view of a shower diverter trim showing our design;  
FIG. 2 is a front elevational view;  
FIG. 3 is a rear elevational view;  
FIG. 4 is a side elevational view;  
FIG. 5 is a side elevational view;  
FIG. 6 is a top plan view; and,  
FIG. 7 is a bottom plan view.

The broken line disclosures in the view represents portions of the shower diverter trim in which the claimed design is embodied, but which forms no part of the claimed design.

(56) **References Cited**

**U.S. PATENT DOCUMENTS**

D290,163 S *	6/1987	Kohler, Jr.	D23/252
D494,254 S	8/2004	Citterio	
D542,384 S	5/2007	Starck	

**1 Claim, 7 Drawing Sheets**

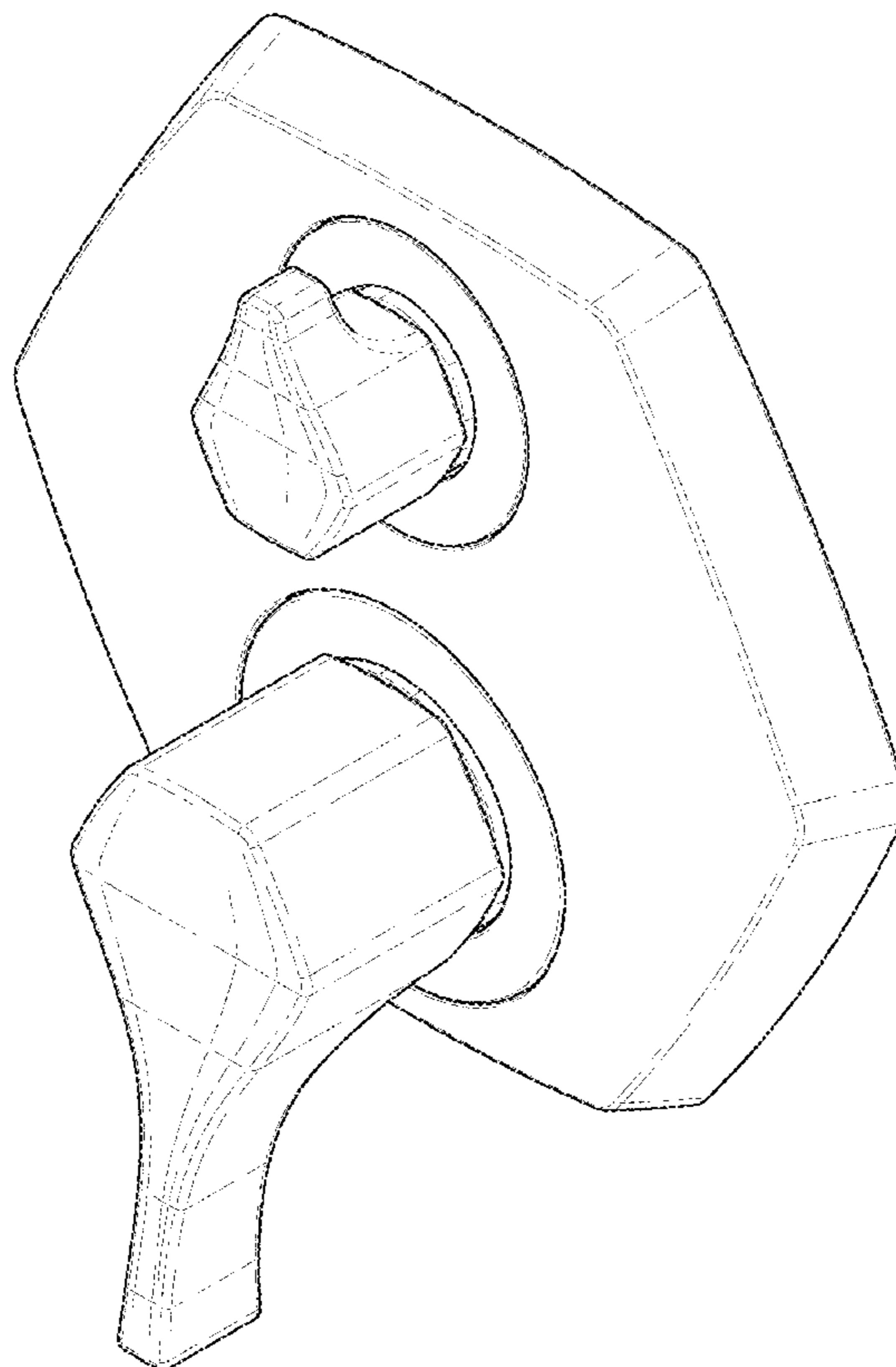

FIG. 1

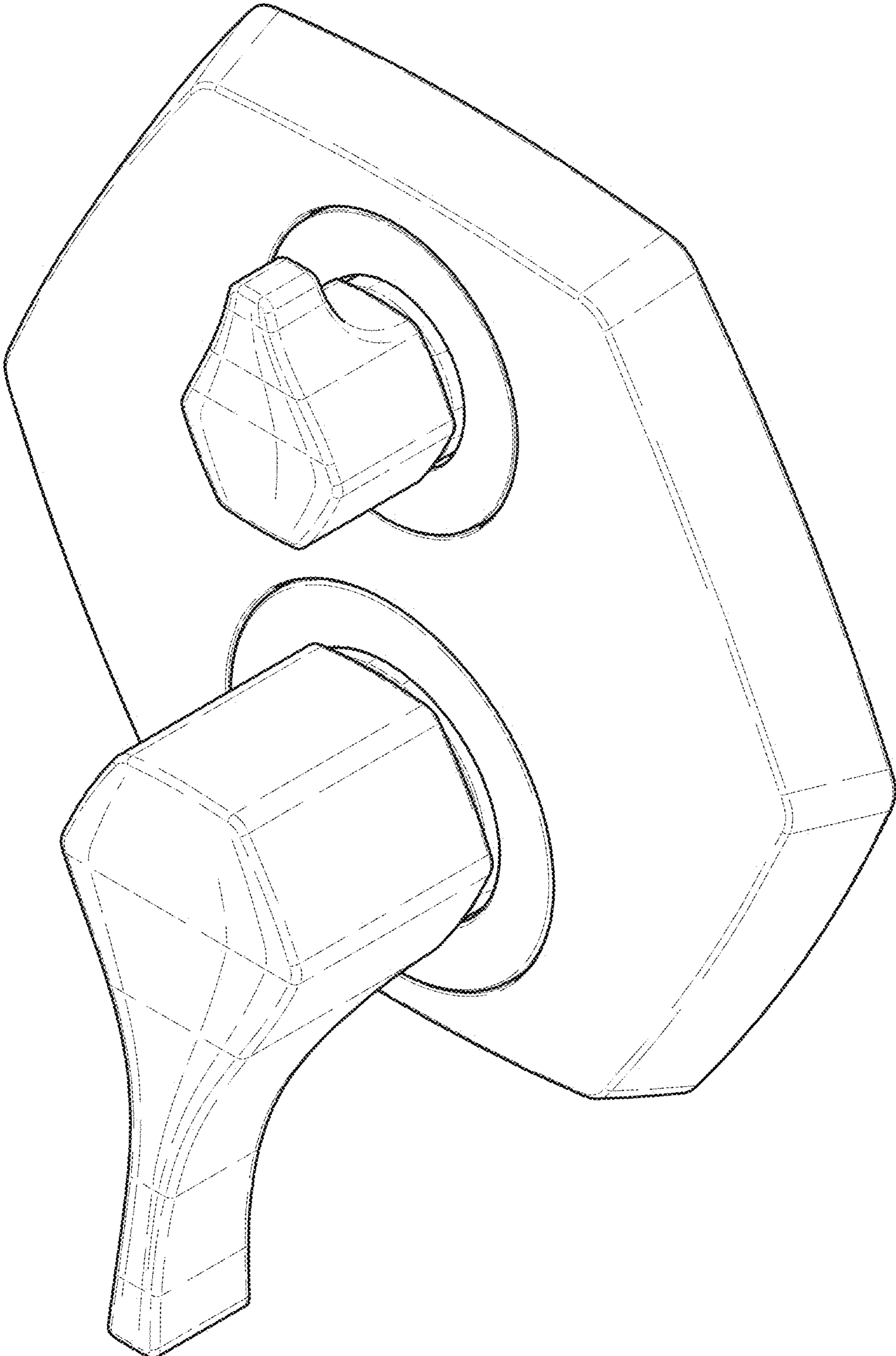

FIG. 2

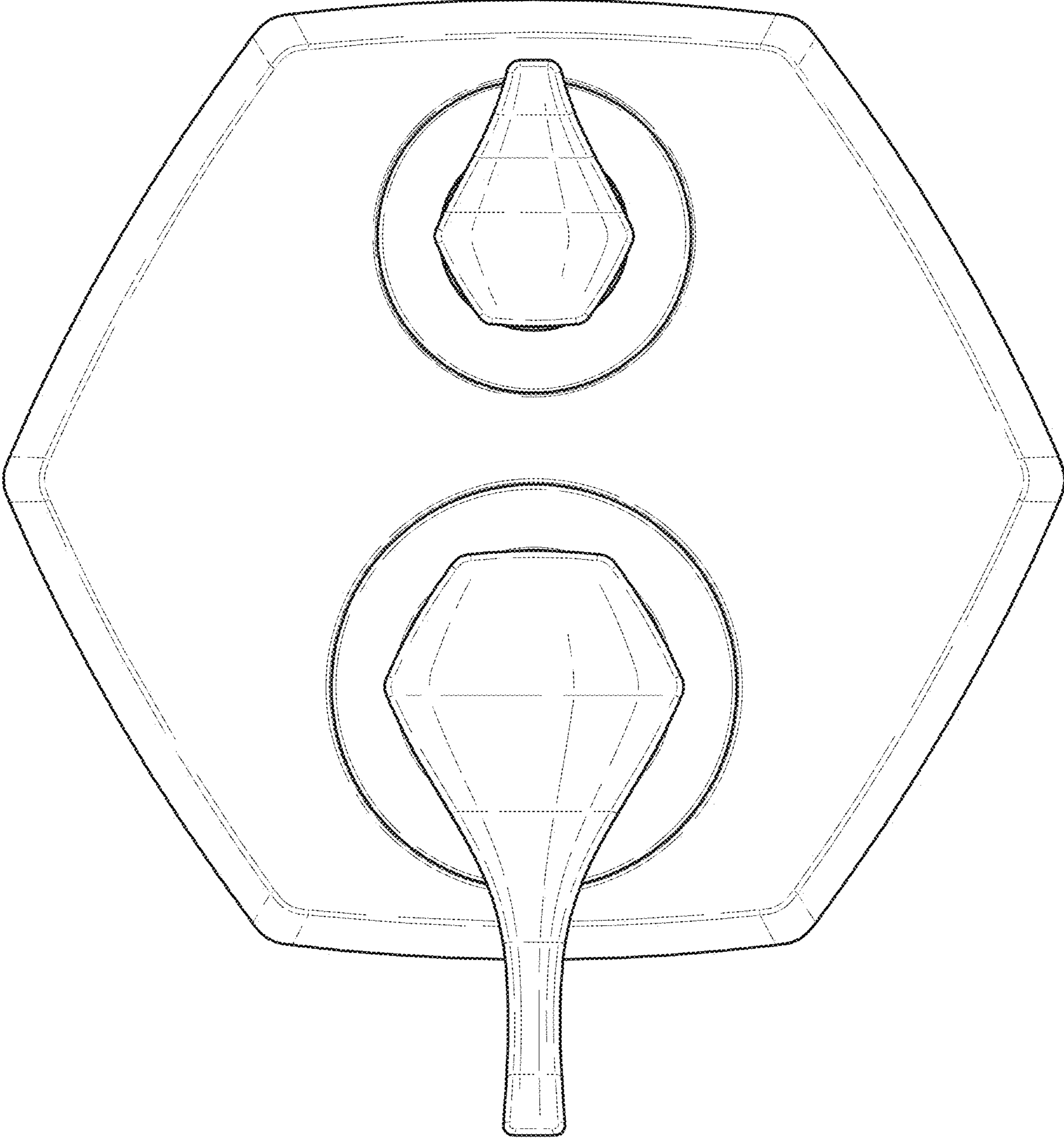

FIG. 3

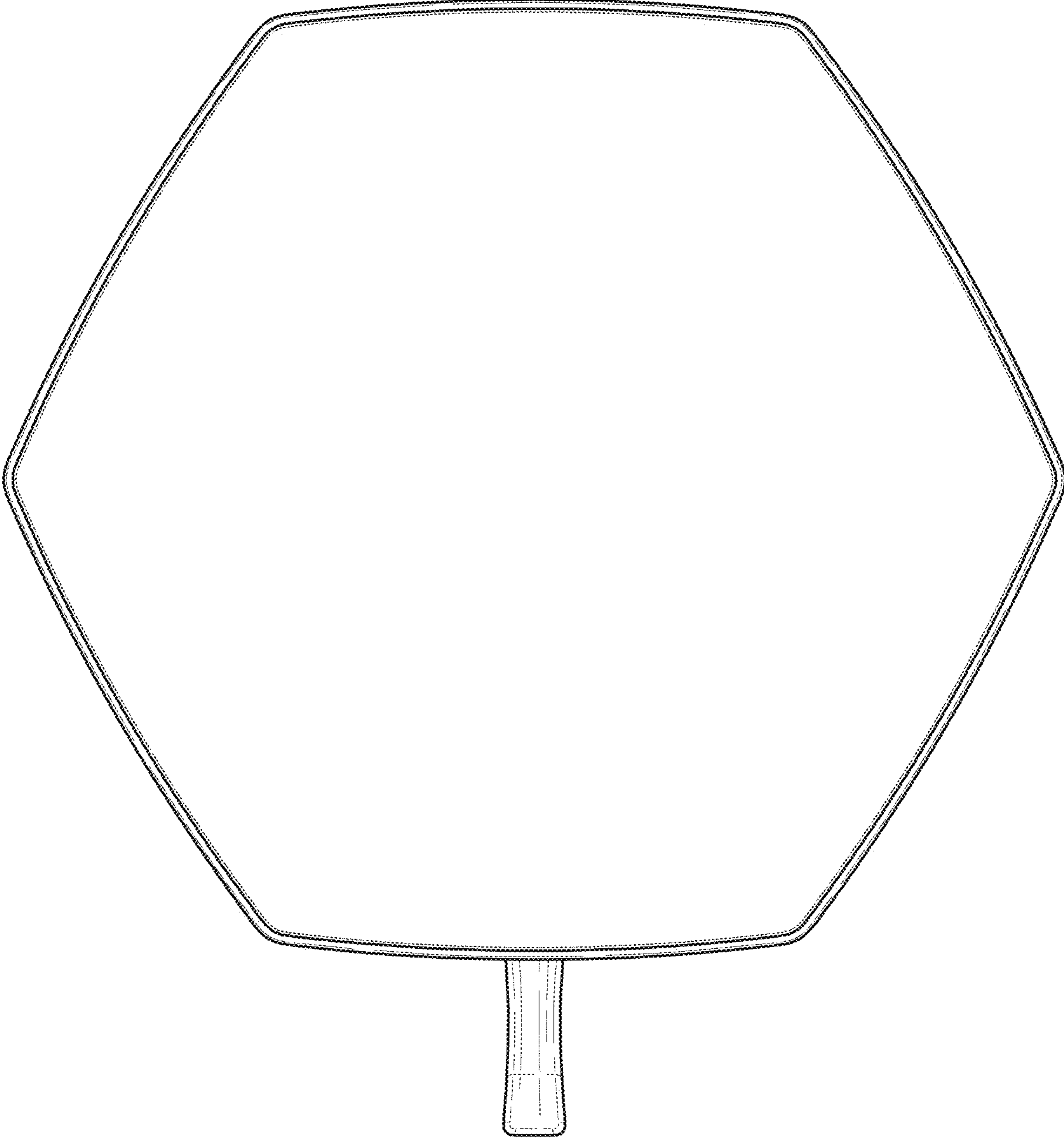

FIG. 4

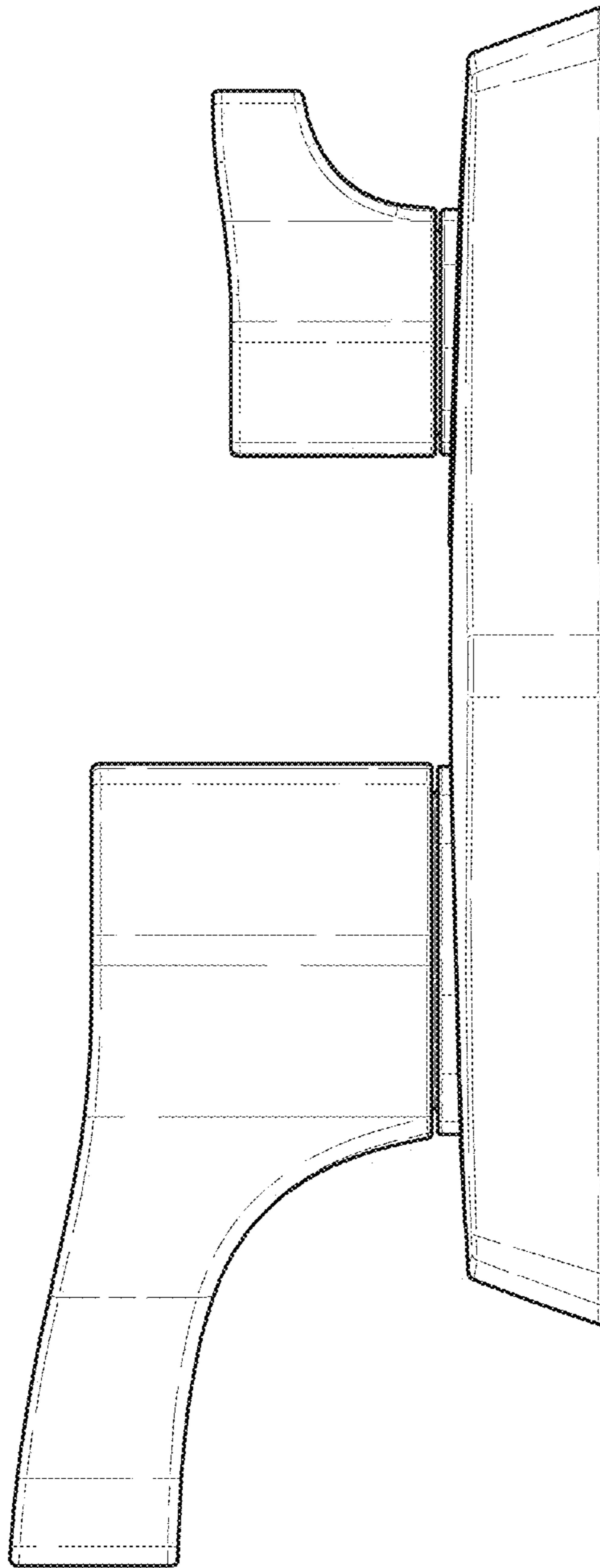

FIG. 5

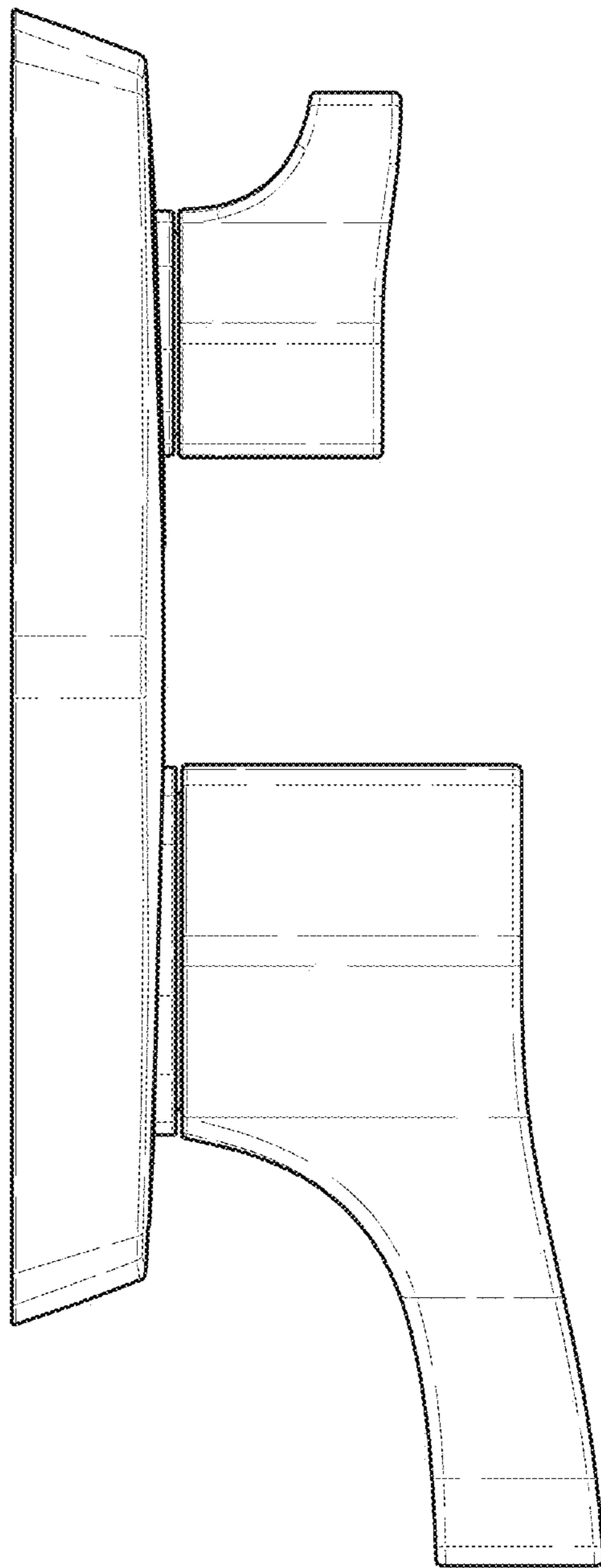

FIG. 6

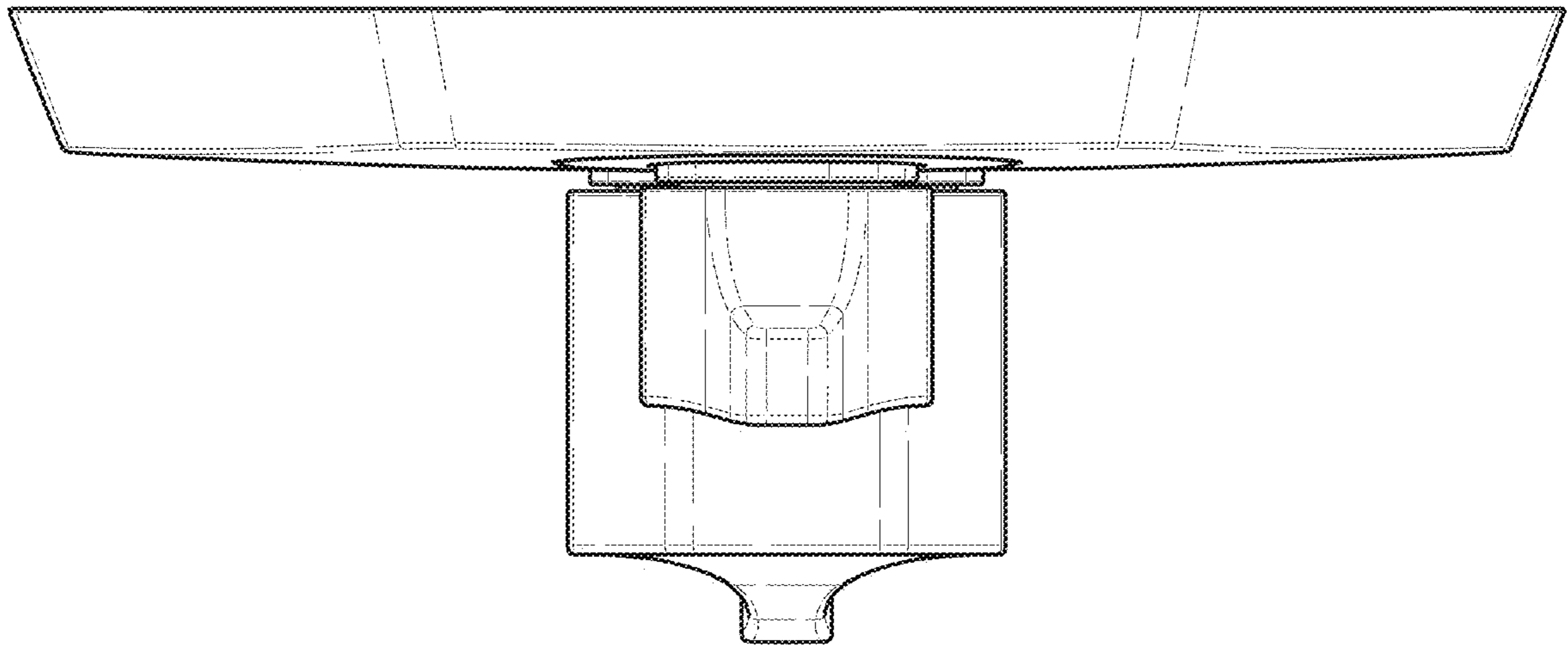

FIG. 7

