



US00D954845S

(12) **United States Design Patent** (10) **Patent No.:** **US D954,845 S**  
**Johnson et al.** (45) **Date of Patent:** **\*\* Jun. 14, 2022**

(54) **GAMING MACHINE**

(71) Applicant: **IGT, Las Vegas, NV (US)**

(72) Inventors: **Charles Johnson, Reno, NV (US);  
Jean-Pierre Legras, Carson City, NV  
(US); James Vasquez, Carson City, NV  
(US); Stewart Thoeni, Reno, NV (US)**

(73) Assignee: **IGT, Las Vegas, NV (US)**

(\*\*) Term: **15 Years**

(21) Appl. No.: **29/682,568**

(22) Filed: **Mar. 6, 2019**

(51) **LOC (13) Cl.** ..... **21-03**

(52) **U.S. Cl.**  
USPC ..... **D21/369**

(58) **Field of Classification Search**  
USPC ..... D21/369, 307, 325, 370, 306, 385, 333;  
D14/341; 463/20, 23  
CPC ..... G07F 17/34; G07F 17/32; G07F 17/3267;  
G07F 17/3211; G07F 17/3213; G07F  
17/3202; G07F 17/3227; A63F 9/24  
See application file for complete search history.

(56) **References Cited**

**U.S. PATENT DOCUMENTS**

D254,249 S	2/1980	Biehl
5,813,914 A	9/1998	McKay et al.
6,688,984 B2	2/2004	Cole
6,997,810 B2	2/2006	Cole
7,267,613 B2	9/2007	Cole
D559,917 S	1/2008	Cole
7,396,282 B2	7/2008	Gauselmann
D604,368 S	11/2009	Lesley et al.
D622,780 S	8/2010	Lesley et al.
D622,781 S	8/2010	Lesley et al.
D646,336 S	10/2011	Kelly et al.

D646,337 S	10/2011	Kelly et al.
8,033,902 B2	10/2011	Wells et al.
8,216,065 B2	7/2012	Kaminkow et al.
D685,033 S *	6/2013	Wudtke ..... D21/370
D706,741 S *	6/2014	Myers ..... D14/172
D712,975 S *	9/2014	Lesley ..... D21/369
8,870,663 B2	10/2014	Cole
8,974,297 B2	3/2015	Massing et al.
9,224,268 B2	12/2015	Aoki et al.
RE46,169 E	10/2016	Kelly et al.
D812,147 S	3/2018	Castro et al.
D812,148 S	3/2018	Castro et al.
D812,149 S	3/2018	Castro et al.
D819,747 S	6/2018	Castro et al.

(Continued)

*Primary Examiner* — Ryan Harvey

(74) *Attorney, Agent, or Firm* — Neal, Gerber & Eisenberg LLP

(57) **CLAIM**

The ornamental design for a gaming machine, as shown and described herein.

**DESCRIPTION**

This application is related to the following commonly owned co-pending patent application: U.S. application Ser. No. 29/682,574, entitled “Gaming Machine Deck”.

FIG. 1 is a front top perspective view of a gaming machine of our new design.

FIG. 2 is a front view of the gaming machine of FIG. 1.

FIG. 3 is a rear view of the gaming machine of FIG. 1.

FIG. 4 is a right side view of the gaming machine of FIG. 1.

FIG. 5 is a left side view of the gaming machine of FIG. 1.

FIG. 6 is a top view of the gaming machine of FIG. 1; and,

FIG. 7 is a bottom view of the gaming machine of FIG. 1.

The portions shown in phantom are not part of the claimed design.

**1 Claim, 7 Drawing Sheets**

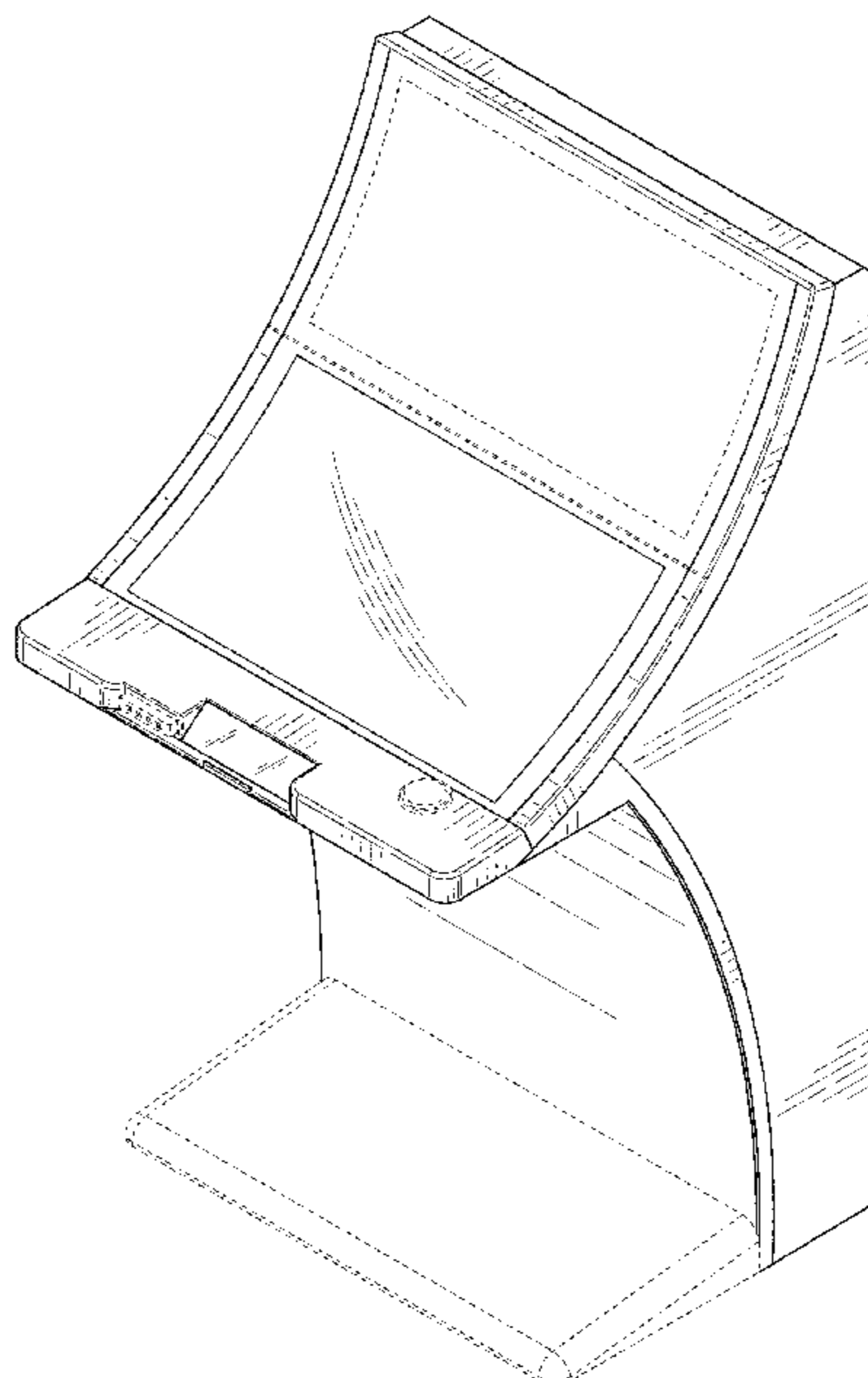

(56)

**References Cited**

## U.S. PATENT DOCUMENTS

D820,915	S *	6/2018	Lee .....	D21/369
D842,930	S	3/2019	Johnson et al.	
D843,467	S	3/2019	Johnson et al.	
D843,468	S	3/2019	Johnson et al.	
D843,474	S *	3/2019	Lesley .....	D21/369
D843,475	S *	3/2019	Lesley .....	D21/369
D843,476	S *	3/2019	Lesley .....	D21/369
D882,696	S *	4/2020	Lesley .....	D21/369
D882,697	S *	4/2020	Lesley .....	D21/369
D882,698	S *	4/2020	Lesley .....	D21/369
D895,019	S *	9/2020	Lesley .....	D21/369
D923,102	S *	6/2021	McGahn .....	D21/370
D934,347	S *	10/2021	Ocampo .....	D21/370
D934,953	S *	11/2021	Kaminkow .....	D21/300
2006/0046849	A1	3/2006	Kovacs	
2008/0182652	A1	7/2008	Rasmussen et al.	
2009/0221375	A1	9/2009	Luciano et al.	
2009/0233681	A1	9/2009	Tsukahara	
2018/0075689	A1 *	3/2018	Castro .....	A63F 13/24
2018/0078854	A1	3/2018	Achmueller et al.	
2018/0089960	A1	3/2018	Caputo et al.	
2019/0046872	A1 *	2/2019	Glenn, II .....	A63F 13/25
2019/0066433	A1 *	2/2019	Jadeja .....	G07F 17/3211
2019/0318575	A1	10/2019	Nelson et al.	
2021/0134109	A1 *	5/2021	Hemerick .....	G07F 17/3223

\* cited by examiner

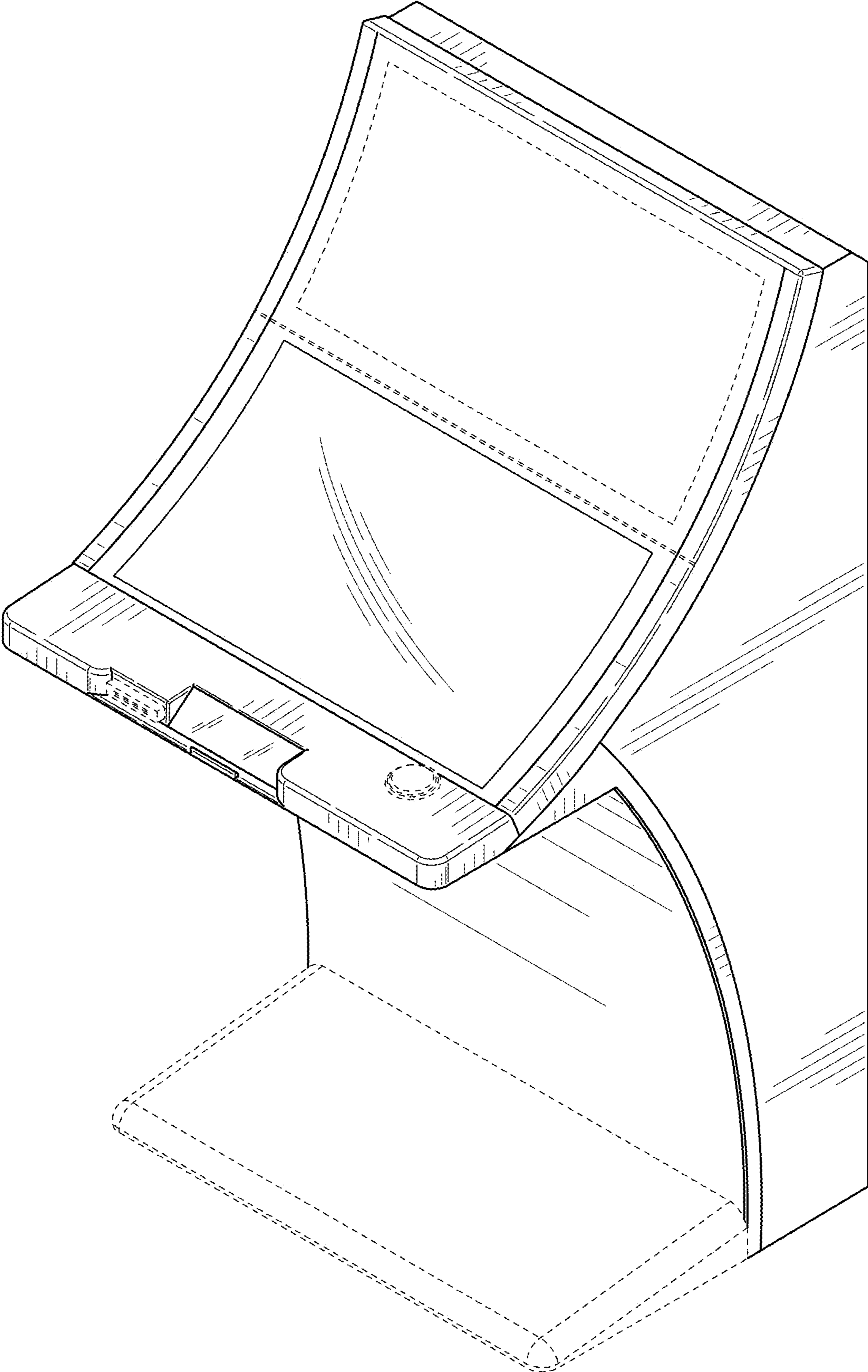

FIG. 1

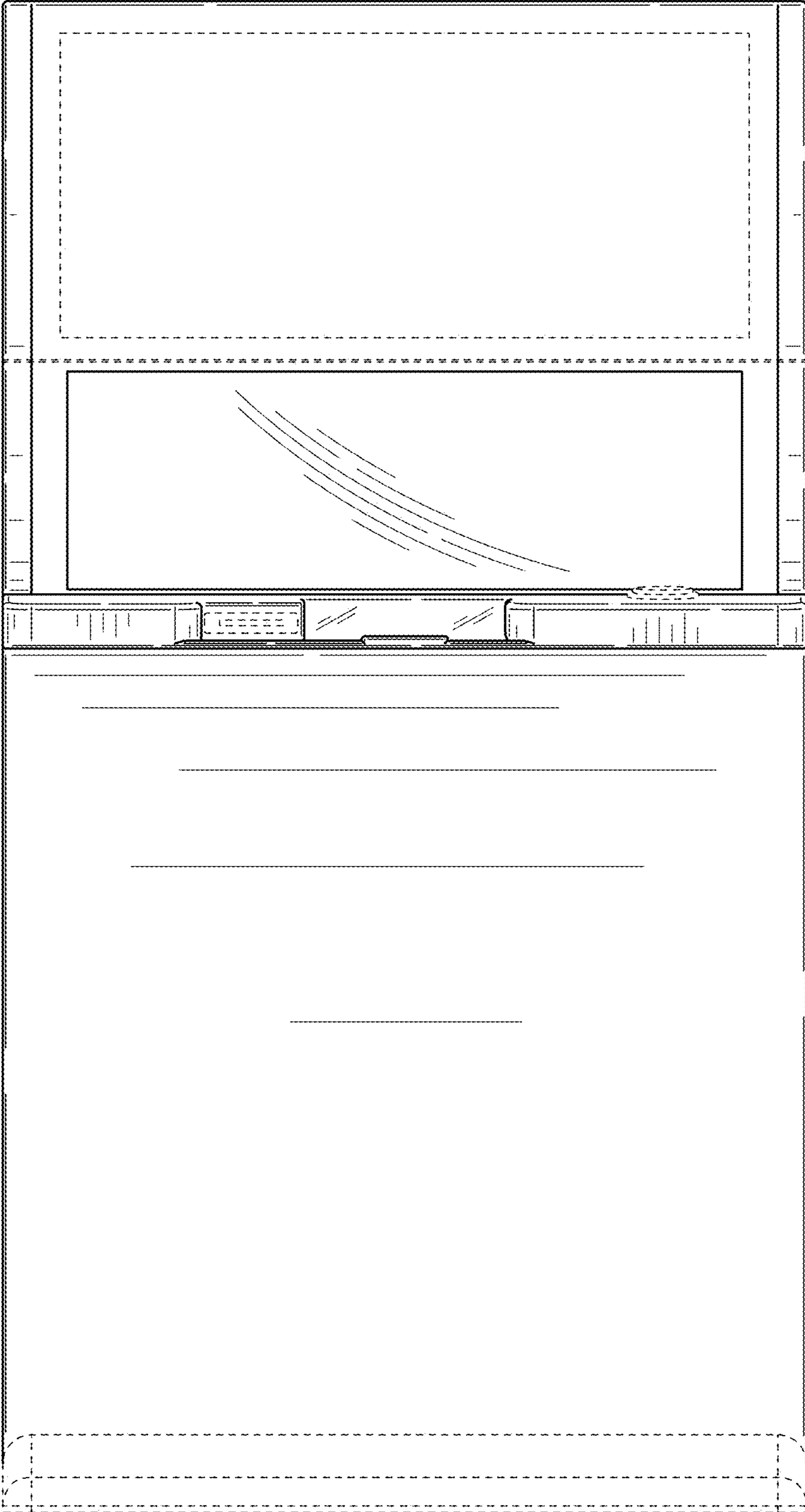

FIG. 2

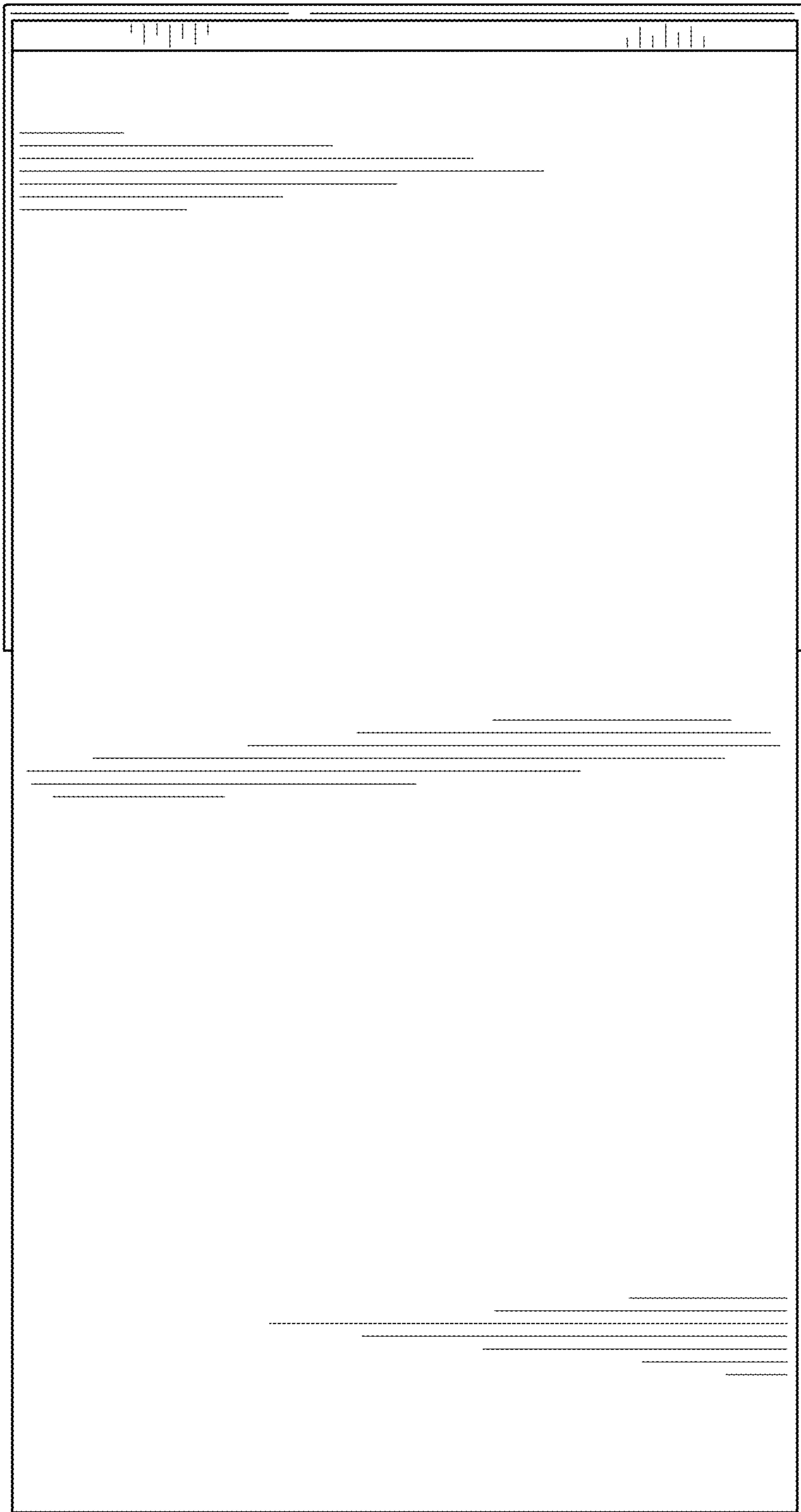

FIG. 3

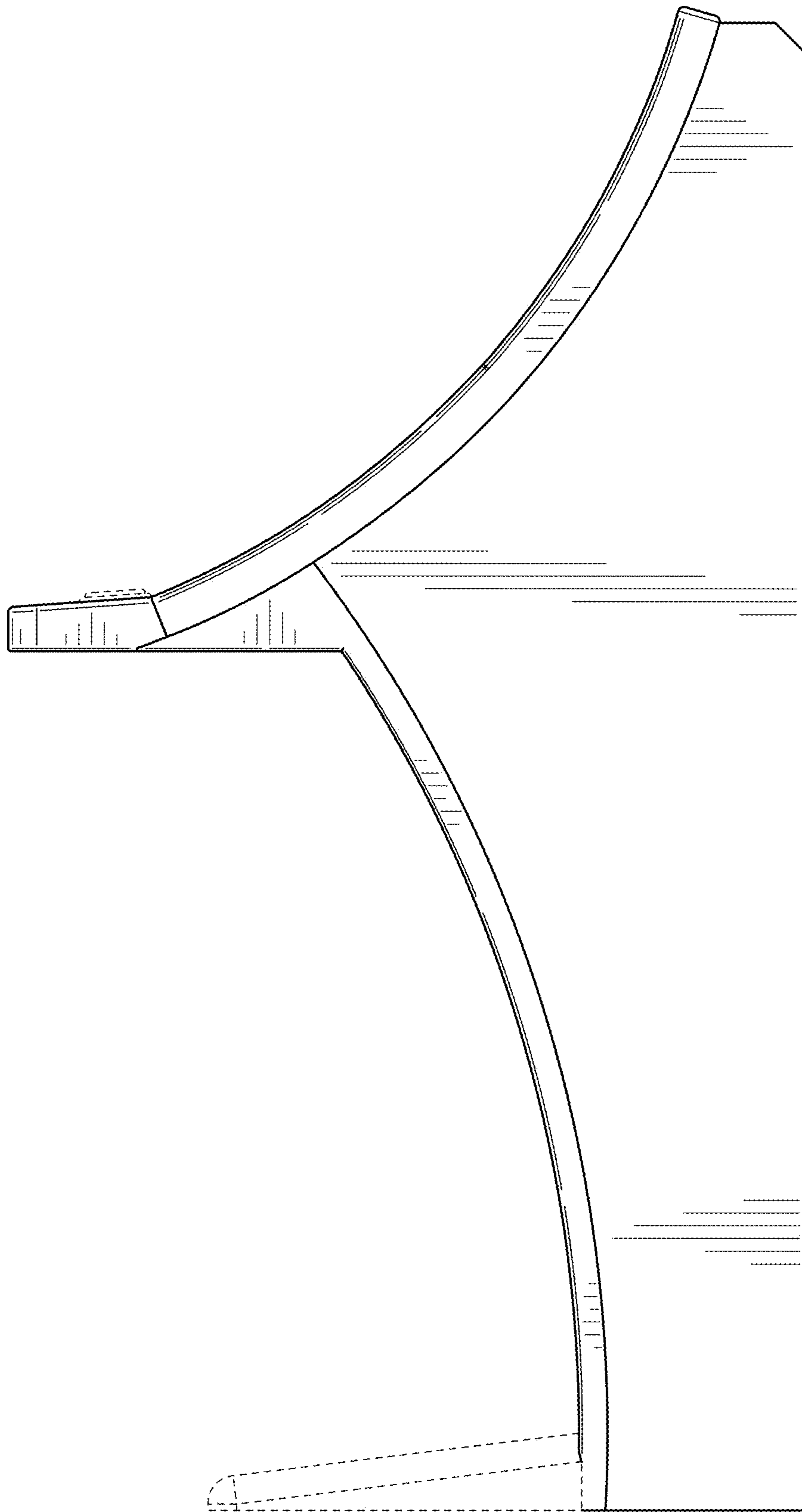

FIG. 4

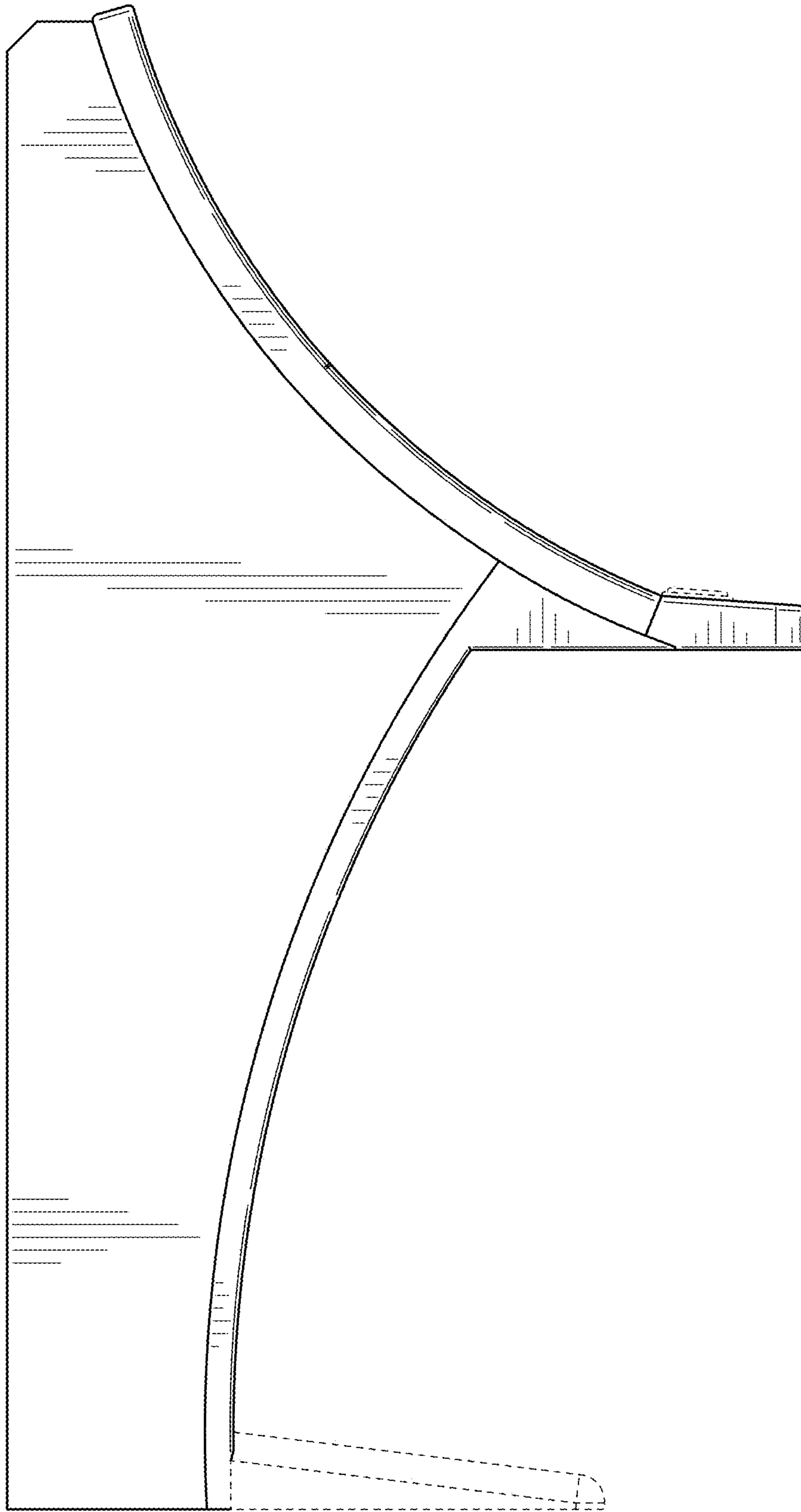

FIG. 5

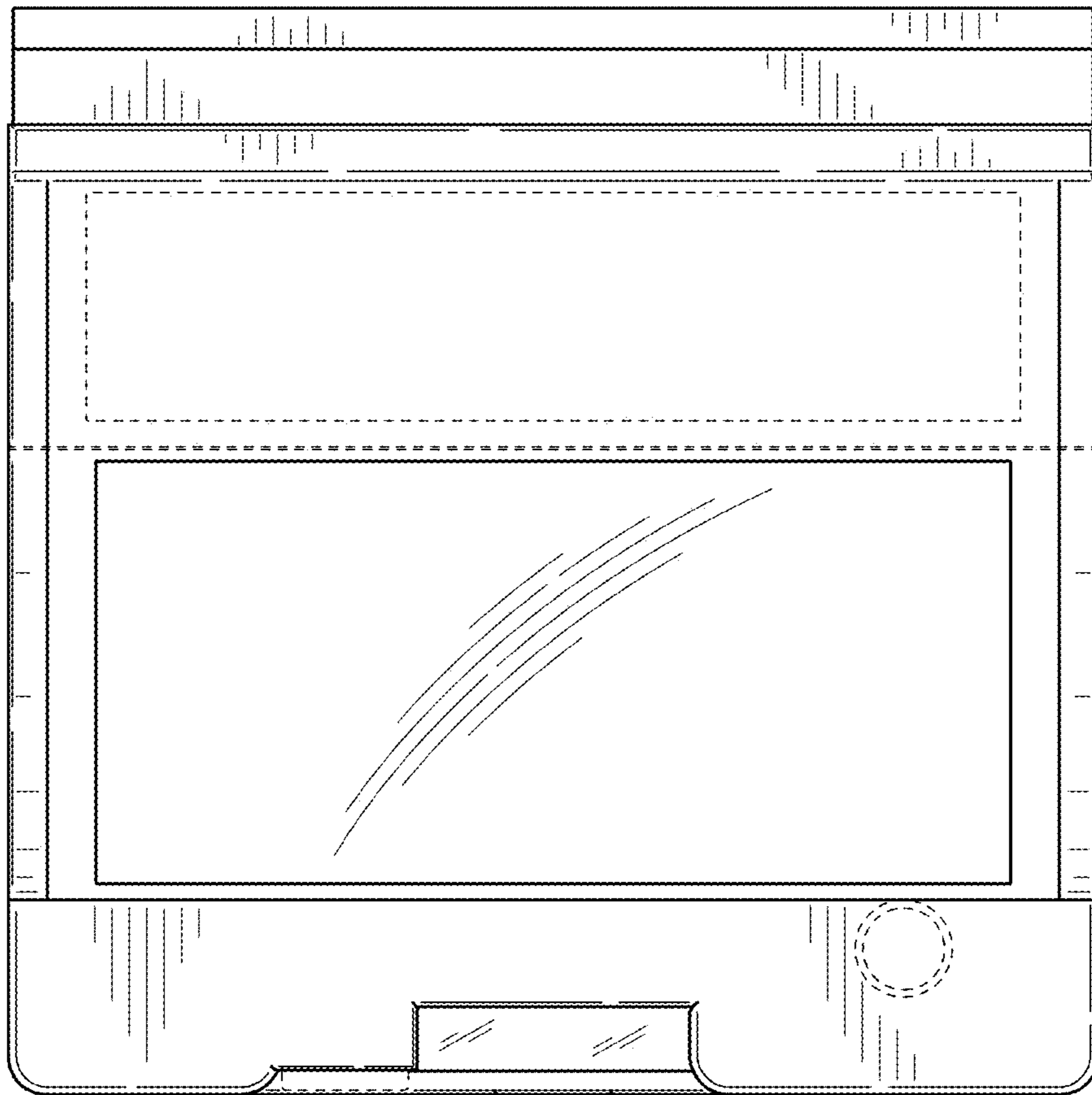

FIG. 6



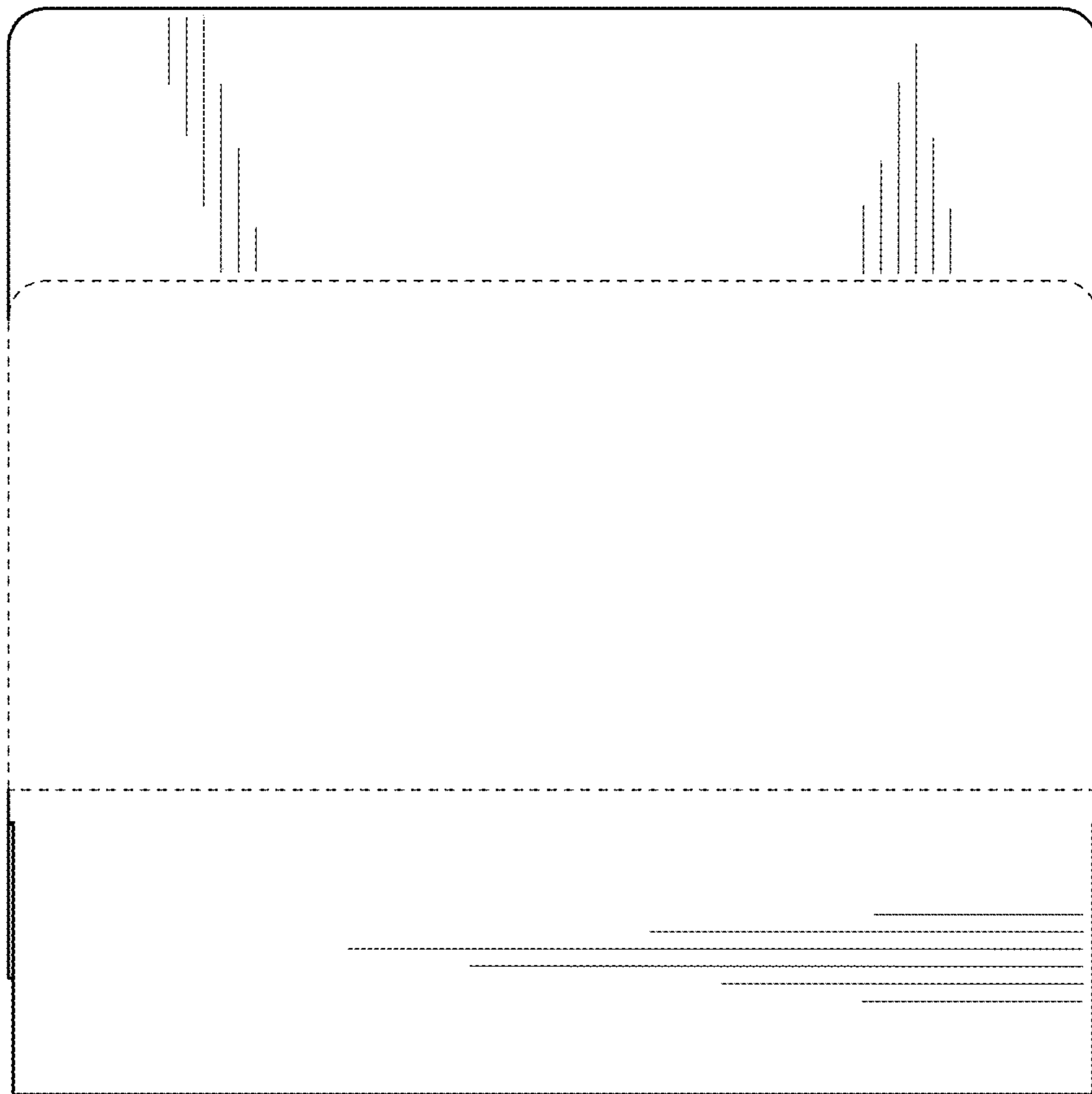

FIG. 7