



US00D954761S

(12) **United States Design Patent**
Lee et al.

(10) **Patent No.: US D954,761 S**
(45) **Date of Patent: ** Jun. 14, 2022**

(54) **REAR BODY ASSEMBLY FOR A WORK VEHICLE**

D678,359 S * 3/2013 Hagura D15/28
D680,136 S * 4/2013 Tsukamoto D15/28
D684,602 S * 6/2013 Hagura D15/28

(Continued)

(71) Applicant: **CNH Industrial America LLC**, New Holland, PA (US)

Primary Examiner — Mark A Goodwin

(72) Inventors: **James Hsin Yao Lee**, Bolingbrook, IL (US); **Eric Michael Jacobsthal**, Elmhurst, IL (US); **Jakub Sulikowski**, Gdansk (PL); **David Melvin Wilkie**, Turin (IT)

(74) *Attorney, Agent, or Firm* — Rickard K. DeMille; Rebecca L. Henkel

(57) **CLAIM**

The ornamental design for a rear body assembly for a work vehicle, as shown and described.

DESCRIPTION

(73) Assignee: **CNH Industrial America LLC**, New Holland, PA (US)

FIG. 1 is a rear perspective view of a rear body assembly for a work vehicle according to an exemplary embodiment of the present subject matter.

(**) Term: **15 Years**

FIG. 2 is a rear view of the rear body assembly illustrated in FIG. 1.

(21) Appl. No.: **29/685,639**

FIG. 3 is a front view of the rear body assembly illustrated in FIG. 1.

(22) Filed: **Mar. 29, 2019**

FIG. 4 is a first side view of the rear body assembly illustrated in FIG. 1.

(51) **LOC (13) Cl.** **15-03**

(52) **U.S. Cl.**

USPC **D15/28**

(58) **Field of Classification Search**

USPC D15/10, 22-29, 30, 33, 31; D34/34, 35

CPC E02F 9/18; B62D 49/085; B62D 49/08;

B66C 23/72; B66C 23/74

See application file for complete search history.

FIG. 5 is a second side view of the rear body assembly illustrated in FIG. 1.

FIG. 6 is a top view of the rear body assembly illustrated in FIG. 1.

FIG. 7 is a bottom view of the rear body assembly illustrated in FIG. 1; and,

(56) **References Cited**

U.S. PATENT DOCUMENTS

5,715,615 A * 2/1998 Murakami E02F 3/325
180/69.21

D528,568 S * 9/2006 Kuwae D15/28

D559,279 S * 1/2008 Sakitani D15/28

D579,465 S * 10/2008 Ochi D15/28

D582,947 S * 12/2008 Ueta D15/28

D587,285 S * 2/2009 Murakami D15/28

D637,628 S * 5/2011 Rupp D15/28

D664,569 S * 7/2012 Rupp D15/28

D678,358 S * 3/2013 Hiraoka D15/28

FIG. 8 is another rear perspective view of the rear body assembly illustrated in FIG. 1, particularly illustrating an environmental view of the rear body assembly installed on a work vehicle, such as a wheel loader.

The broken lines contained within the figures, including, but, not limited to, any dash-dot broken lines and/or dash-dash broken lines, represent portions of the rear body assembly for a work vehicle that form no part of the claimed design. Additionally, contour lines and/or surface shading are illustrated simply for purposes of highlighting the solid-rendering, and, thus, form no part of the claimed design.

1 Claim, 8 Drawing Sheets

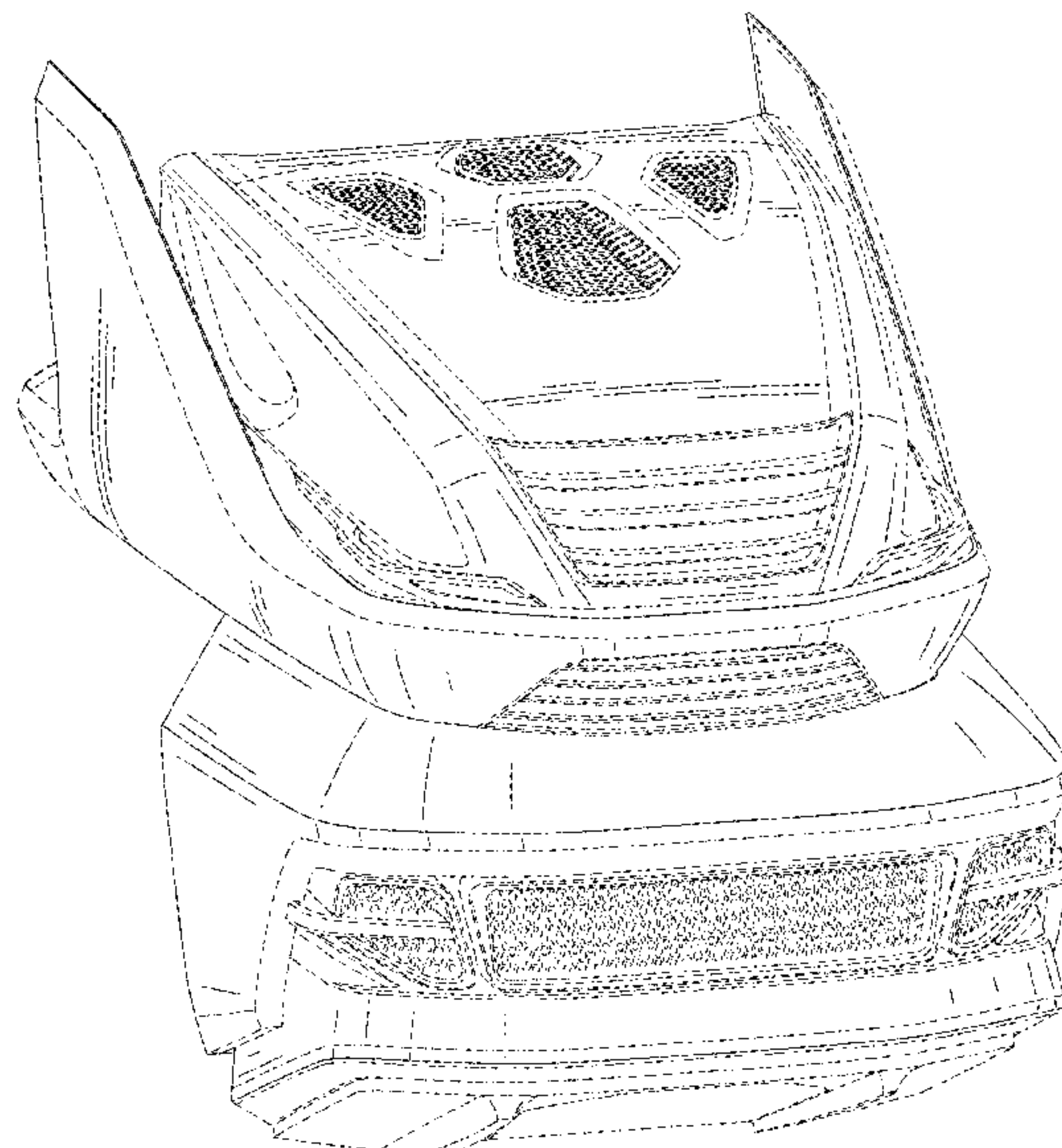

(56)

References Cited

U.S. PATENT DOCUMENTS

D684,603	S	*	6/2013	Hagura	D15/28
D684,604	S	*	6/2013	Saito	D15/28
D693,858	S	*	11/2013	Hagura	D15/28
D723,069	S	*	2/2015	Turner	D15/28
D725,157	S	*	3/2015	Higuchi	D15/28
D726,229	S	*	4/2015	Turner	D15/28
D728,639	S	*	5/2015	Payne	D15/31
D749,150	S	*	2/2016	Payne	D15/31
D767,644	S	*	9/2016	Underhill	D15/28
D768,209	S	*	10/2016	Jilbert	D15/28
D774,105	S	*	12/2016	Jilbert	D15/28
D774,107	S	*	12/2016	Fiser	D15/28
D813,917	S	*	3/2018	Smiley	D15/28
D847,213	S	*	4/2019	Kurosaka	D15/28
D870,779	S	*	12/2019	Jilbert	D15/28
2004/0200100	A1	*	10/2004	Kojima	E02F 9/18 37/348

* cited by examiner

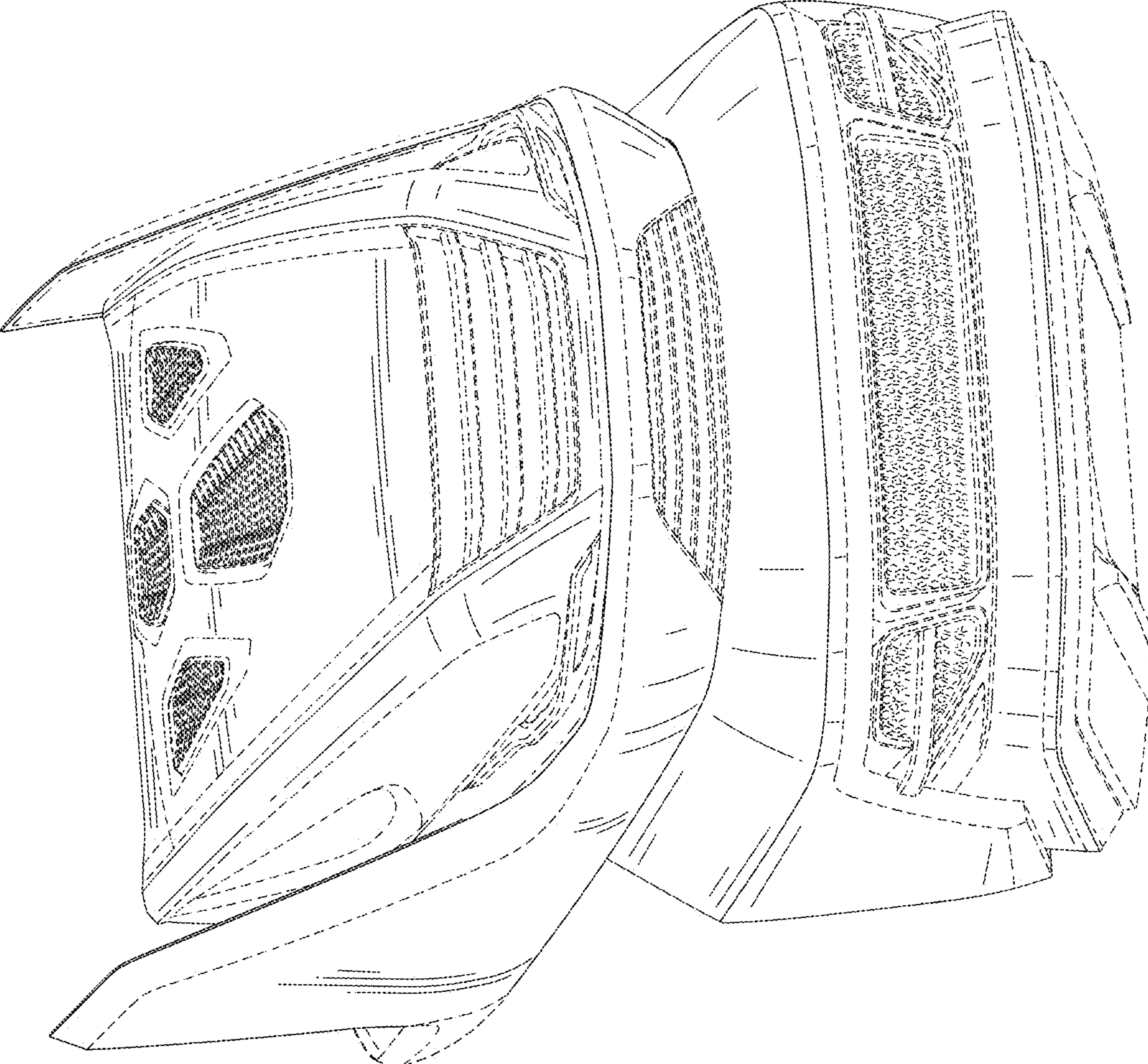

FIG. 1

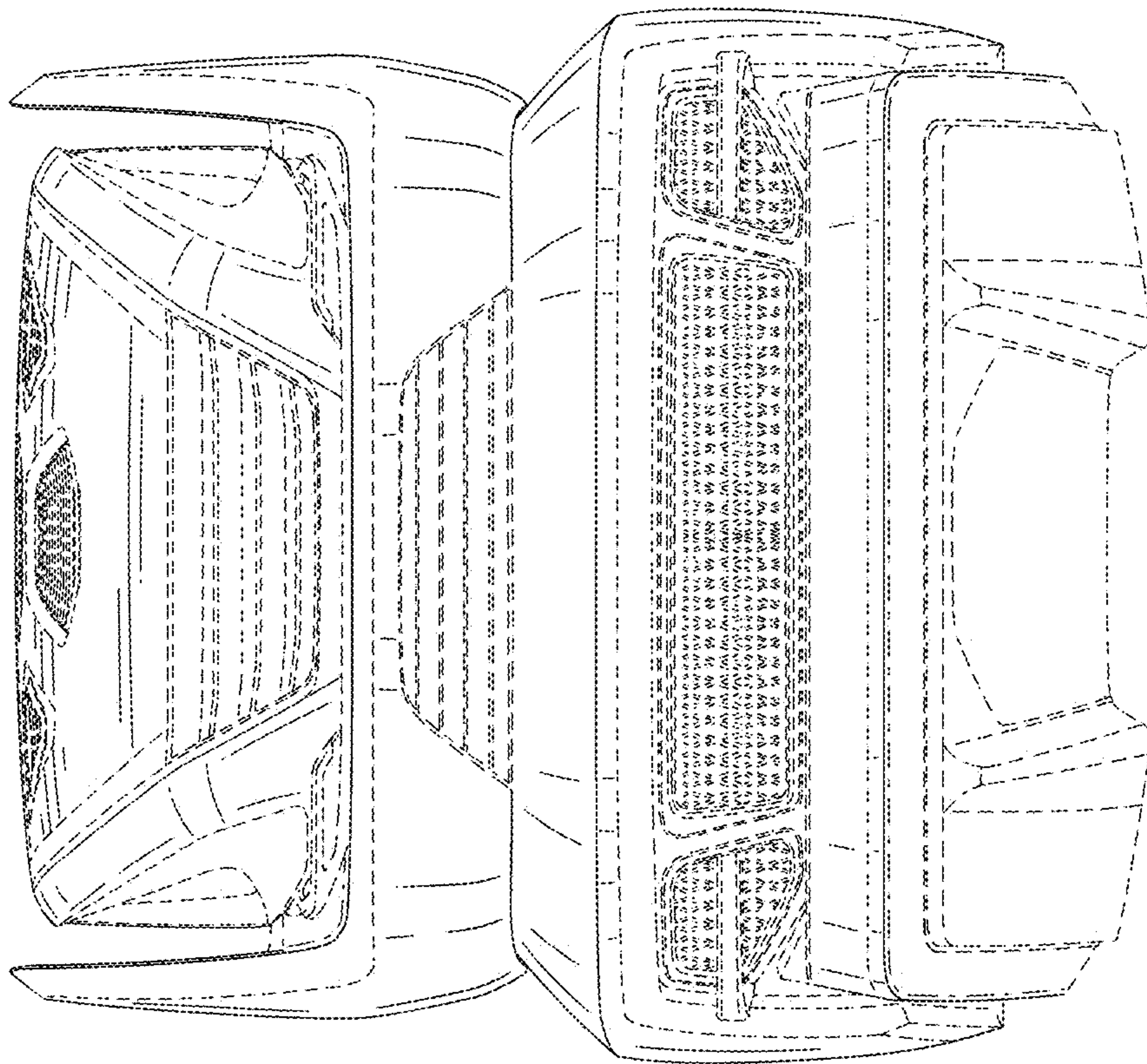

FIG. 2

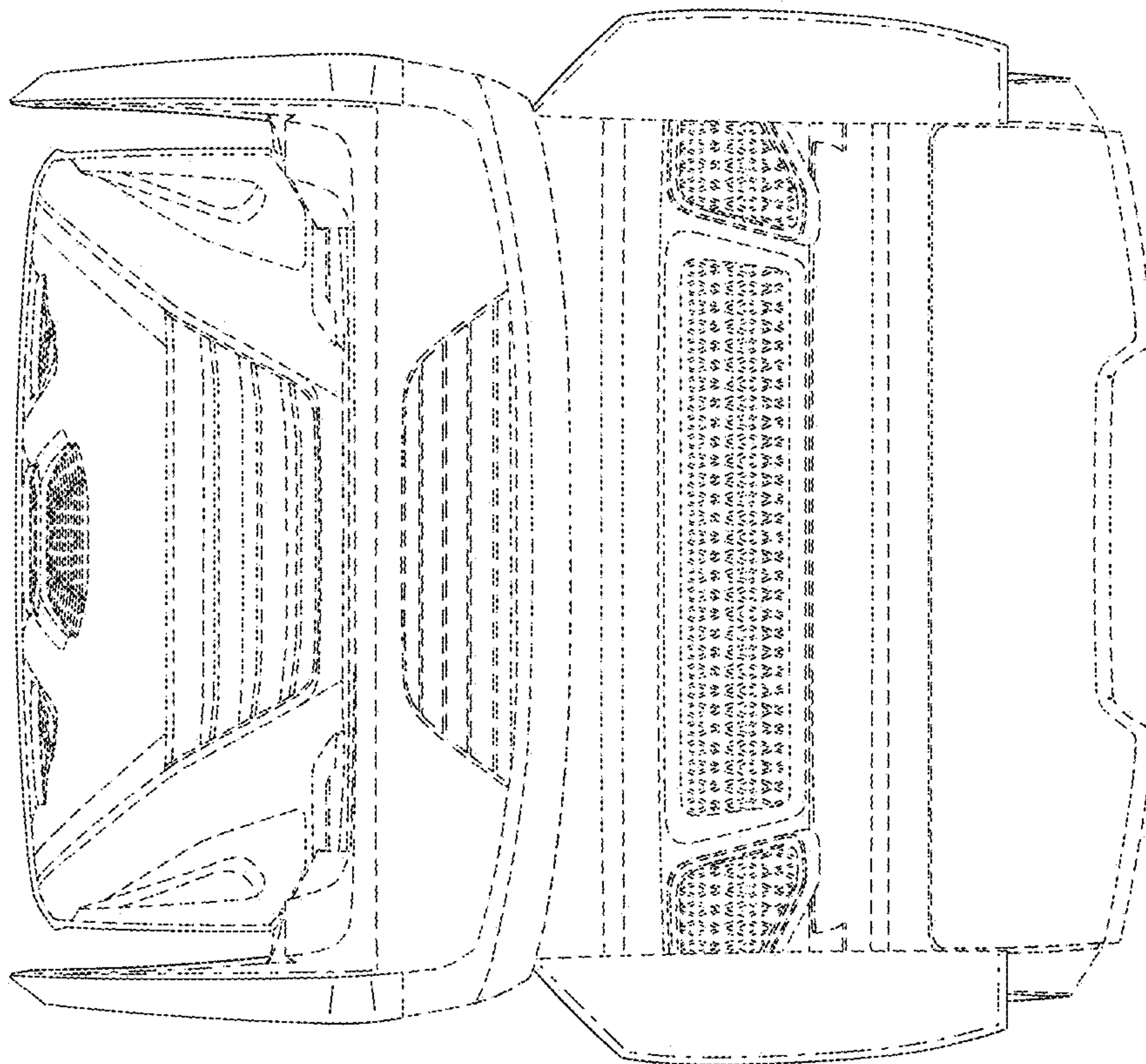

FIG. 3

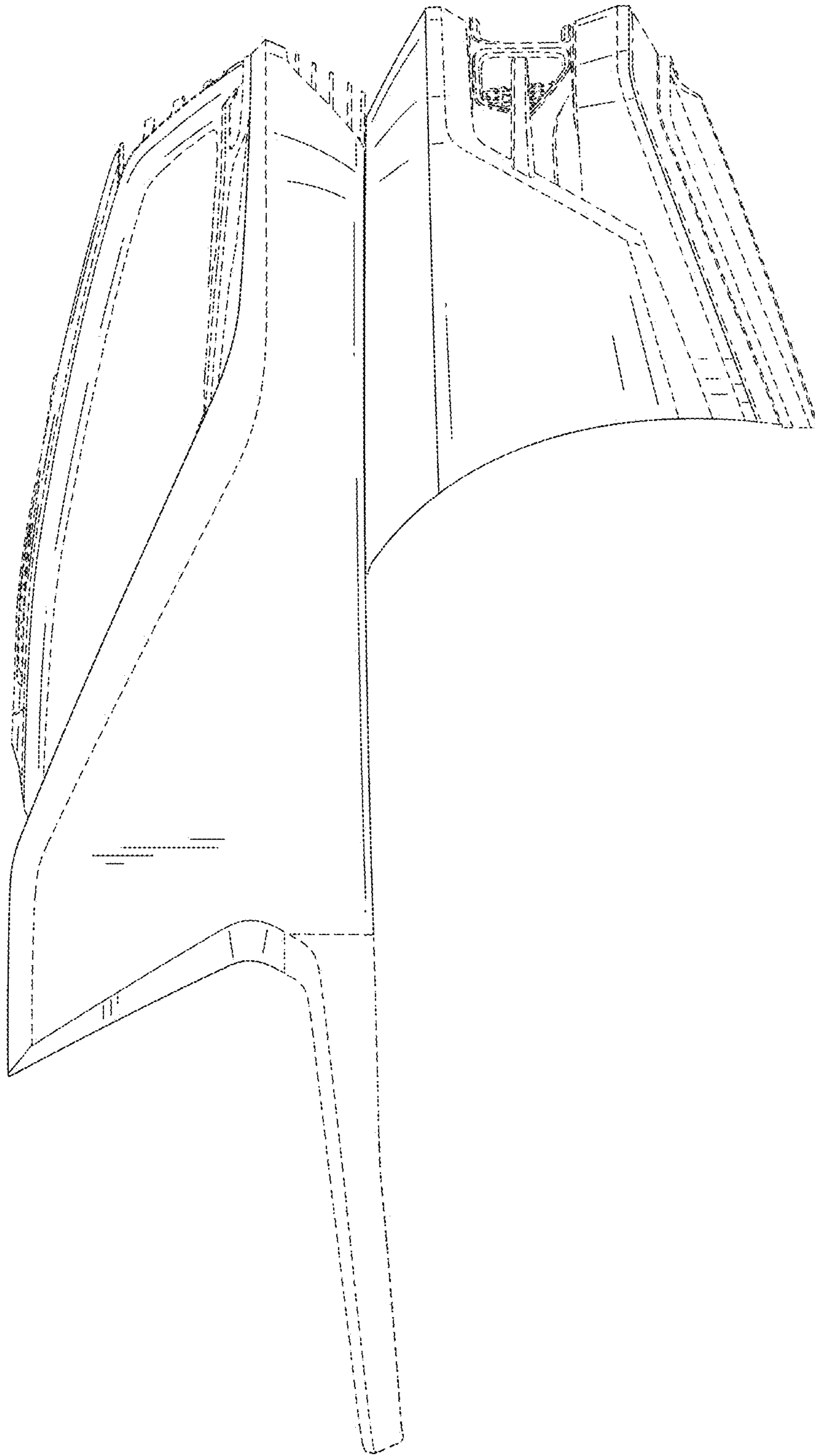

FIG. 4

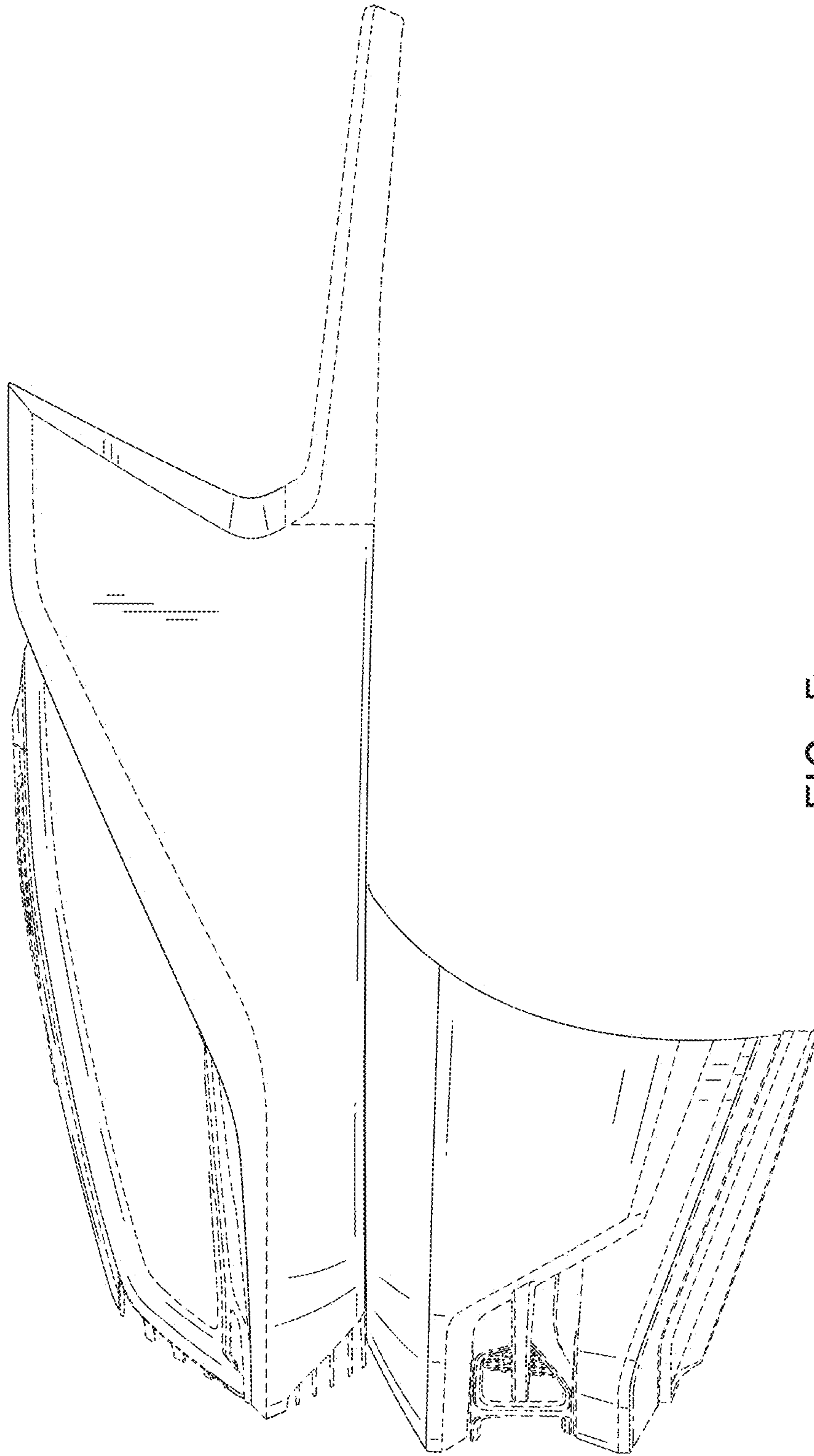

FIG. 5

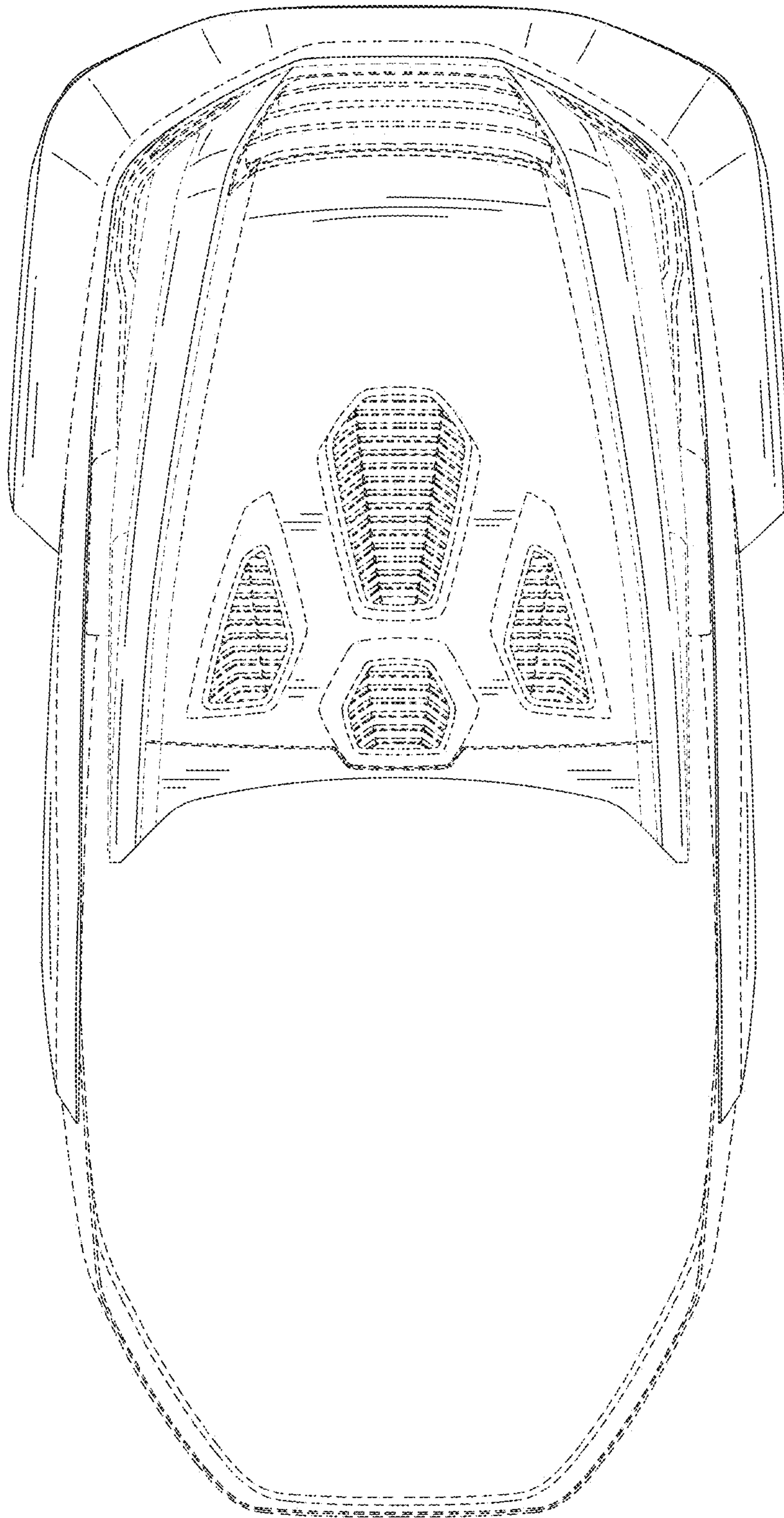

FIG. 6

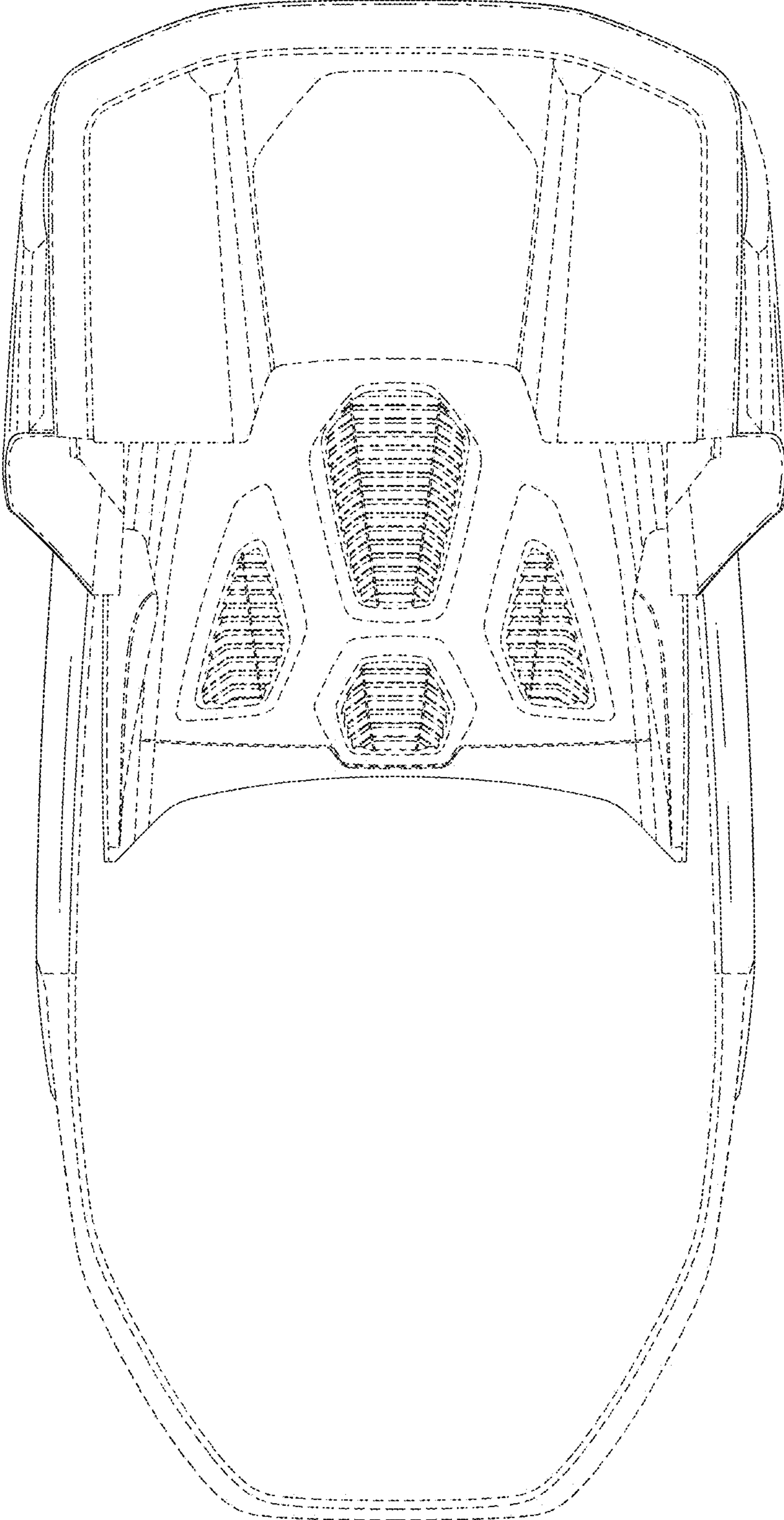

FIG. 7

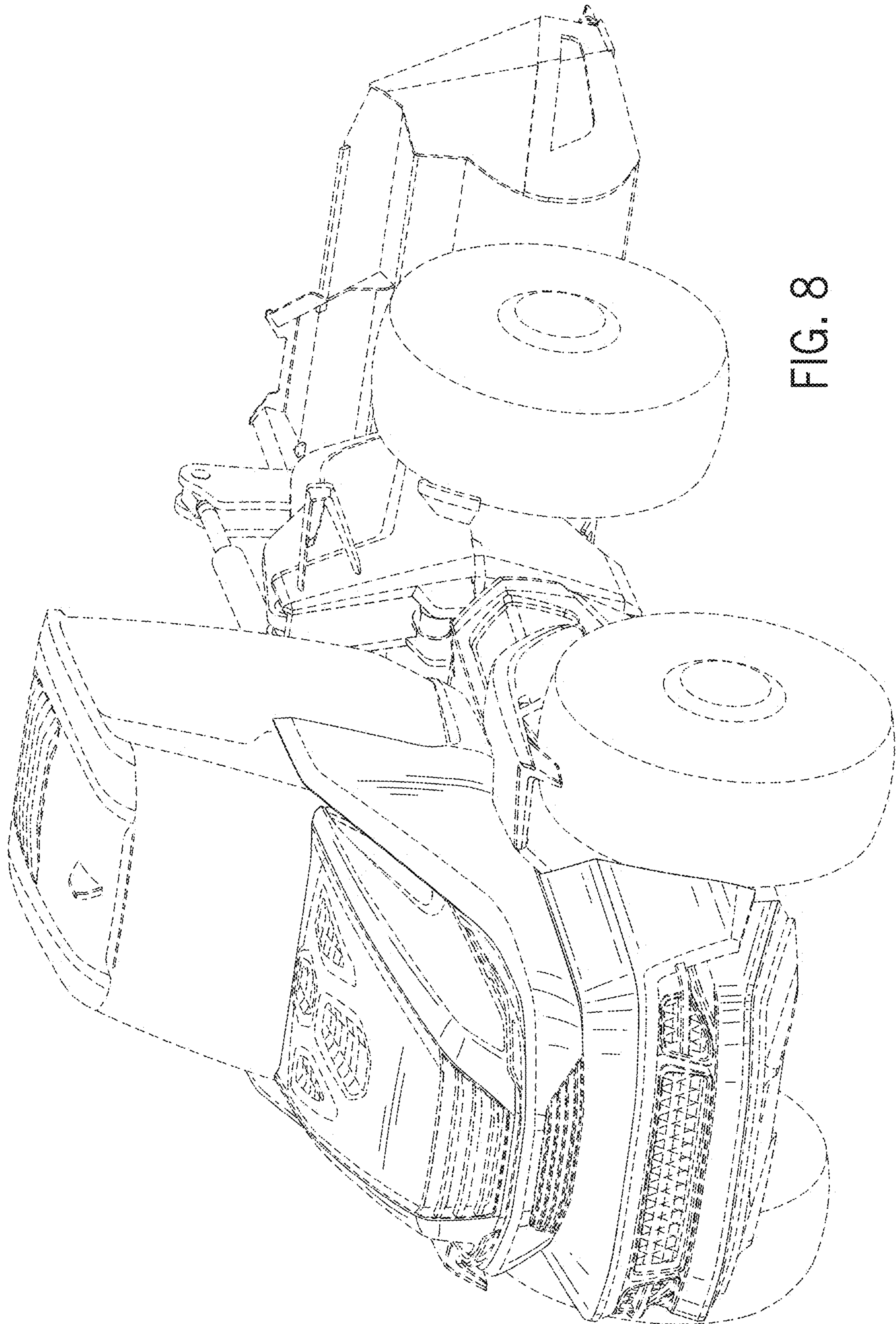

FIG. 8