



US00D954760S

(12) **United States Design Patent**  
**Lee et al.**

(10) **Patent No.:** **US D954,760 S**  
(45) **Date of Patent:** **\*\* Jun. 14, 2022**

(54) **BALLAST FOR A WORK VEHICLE**

(71) Applicant: **CNH Industrial America LLC**, New Holland, PA (US)

(72) Inventors: **James Hsin Yao Lee**, Bolingbrook, IL (US); **Eric Michael Jacobsthal**, Elmhurst, IL (US); **Jakub Sulikowski**, Gdansk (PL); **David Melvin Wilkie**, Turin (IT)

(73) Assignee: **CNH Industrial America LLC**, New Holland, PA (US)

(\*\*) Term: **15 Years**

(21) Appl. No.: **29/685,631**

(22) Filed: **Mar. 29, 2019**

(51) **LOC (13) Cl.** ..... **15-03**

(52) **U.S. Cl.**  
USPC ..... **D15/28**

(58) **Field of Classification Search**  
USPC ..... D15/10, 22-29, 30, 33, 31; D34/34, 35  
CPC ..... E02F 9/18; B62D 49/085; B62D 49/08;  
B66C 23/72; B66C 23/74  
See application file for complete search history.

(56) **References Cited**

**U.S. PATENT DOCUMENTS**

5,715,615	A *	2/1998	Murakami	.....	E02F 3/325 180/69.21
D528,568	S *	9/2006	Kuwae	.....	D15/28
D559,279	S *	1/2008	Sakitani	.....	D15/28
D579,465	S *	10/2008	Ochi	.....	D15/28
D582,947	S *	12/2008	Ueta	.....	D15/28
D587,285	S *	2/2009	Murakami	.....	D15/28
D637,628	S *	5/2011	Rupp	.....	D15/28
D664,569	S *	7/2012	Rupp	.....	D15/28
D678,358	S *	3/2013	Hiraoka	.....	D15/28
D678,359	S *	3/2013	Hagura	.....	D15/28

D680,136	S *	4/2013	Tsukamoto	.....	D15/28
D684,602	S *	6/2013	Hagura	.....	D15/28
D684,603	S *	6/2013	Hagura	.....	D15/28
D684,604	S *	6/2013	Saito	.....	D15/28
D693,858	S *	11/2013	Hagura	.....	D15/28
D723,069	S *	2/2015	Turner	.....	D15/28

(Continued)

*Primary Examiner* — Mark A Goodwin

(74) *Attorney, Agent, or Firm* — Rickard K. DeMille;  
Rebecca L. Henkel

(57) **CLAIM**

The ornamental design for a ballast for a work vehicle, as shown and described.

**DESCRIPTION**

FIG. 1 is a rear perspective view of a ballast for a work vehicle according to an exemplary embodiment of the present subject matter.

FIG. 2 is a rear view of the ballast illustrated in FIG. 1.

FIG. 3 is a front view of the ballast illustrated in FIG. 1.

FIG. 4 is a first side view of the ballast illustrated in FIG. 1.

FIG. 5 is a second side view of the ballast illustrated in FIG. 1.

FIG. 6 is a top view of the ballast illustrated in FIG. 1.

FIG. 7 is a bottom view of the ballast illustrated in FIG. 1; and,

FIG. 8 is another rear perspective view of the ballast illustrated in FIG. 1, particularly illustrating an environmental view of the ballast installed on a work vehicle, such as a wheel loader.

The broken lines contained within the figures, including, but, not limited to, any dash-dot broken lines and/or dash-dash broken lines, represent portions of the ballast for a work vehicle that form no part of the claimed design. Additionally, contour lines and/or surface shading are illustrated simply for purposes of highlighting the solid-rendering, and, thus, form no part of the claimed design.

**1 Claim, 8 Drawing Sheets**

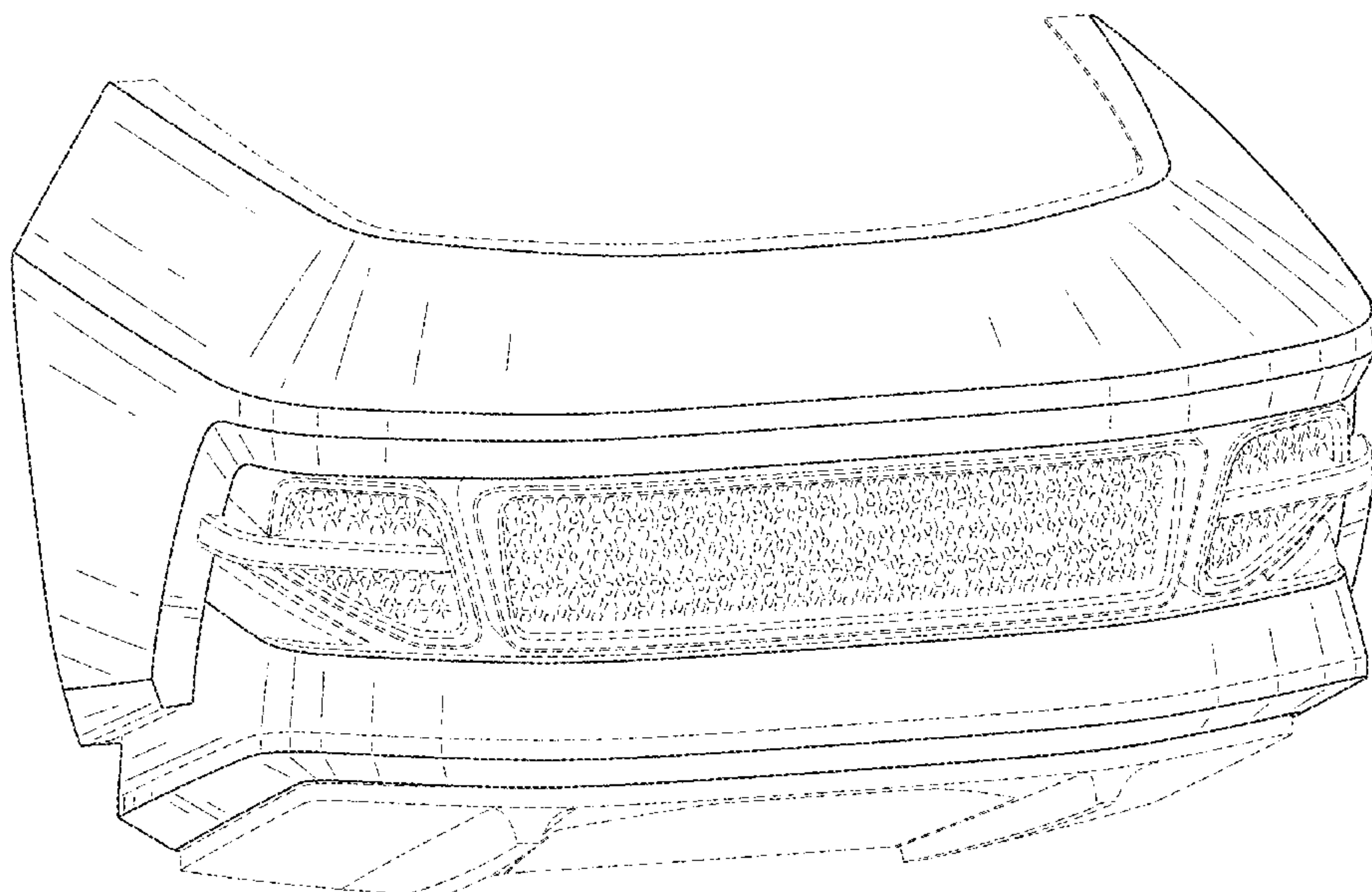

(56)

**References Cited**

U.S. PATENT DOCUMENTS

D725,157 S *	3/2015	Higuchi .....	D15/28
D726,229 S *	4/2015	Turner .....	D15/28
D728,639 S *	5/2015	Payne .....	D15/31
D749,150 S *	2/2016	Payne .....	D15/31
D767,644 S *	9/2016	Underhill .....	D15/28
D768,209 S *	10/2016	Jilbert .....	D15/28
D774,105 S *	12/2016	Jilbert .....	D15/28
D774,107 S *	12/2016	Fiser .....	D15/28
D813,917 S *	3/2018	Smiley .....	D15/28
D847,213 S *	4/2019	Kurosaka .....	D15/28
D870,779 S *	12/2019	Jilbert .....	D15/28
2004/0200100 A1 *	10/2004	Kojima .....	E02F 9/18 37/348

\* cited by examiner

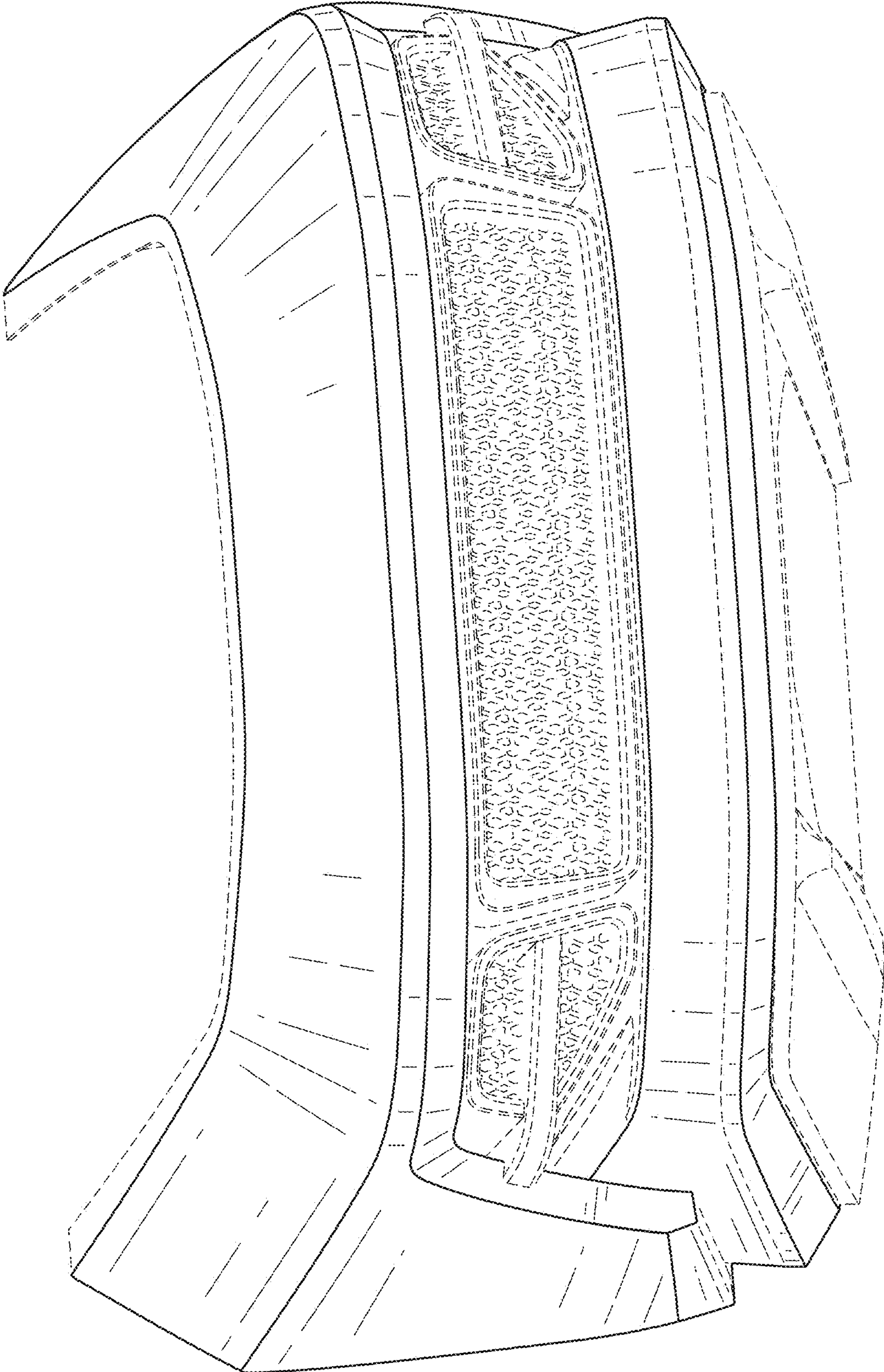

FIG. 1



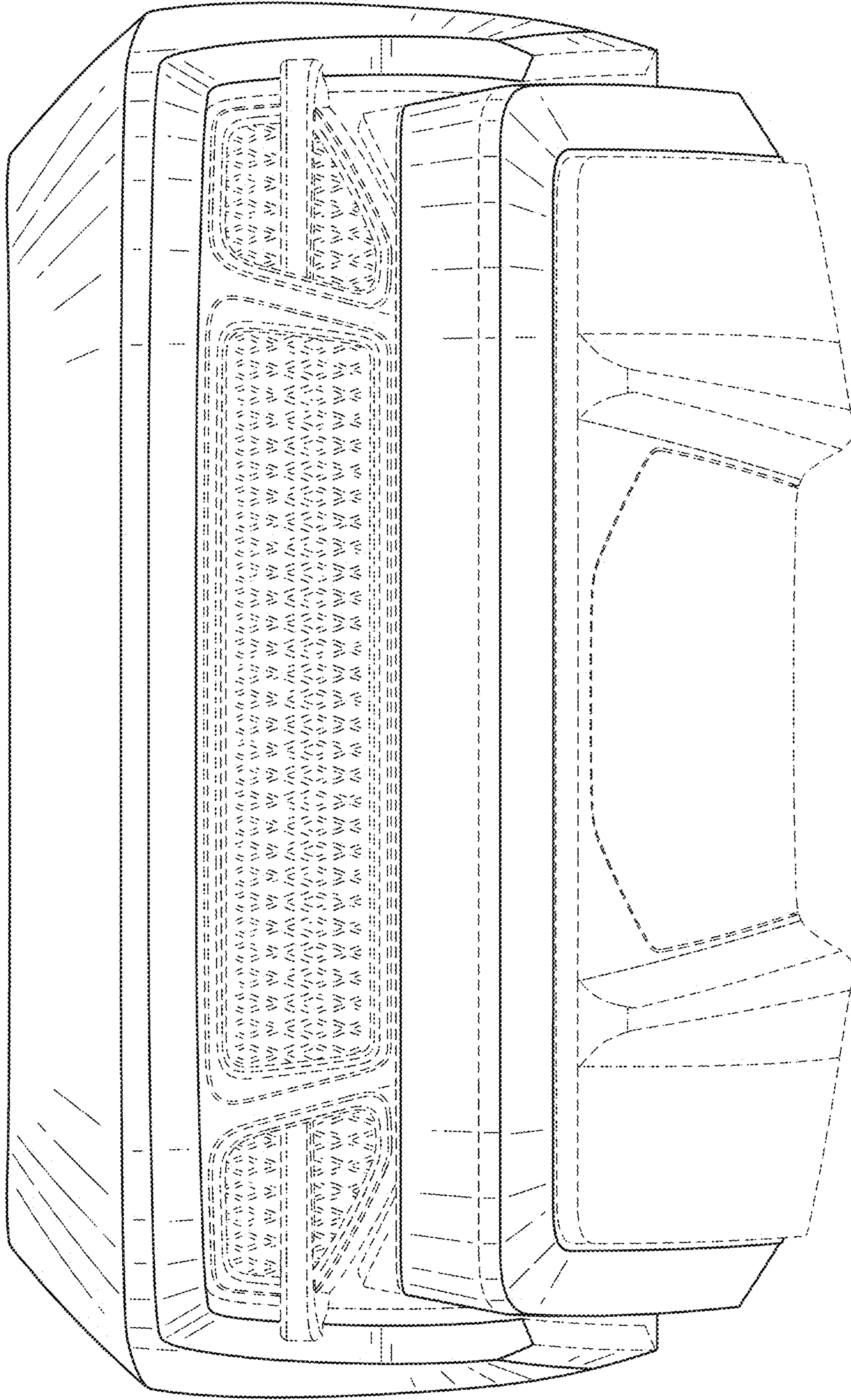

FIG. 2

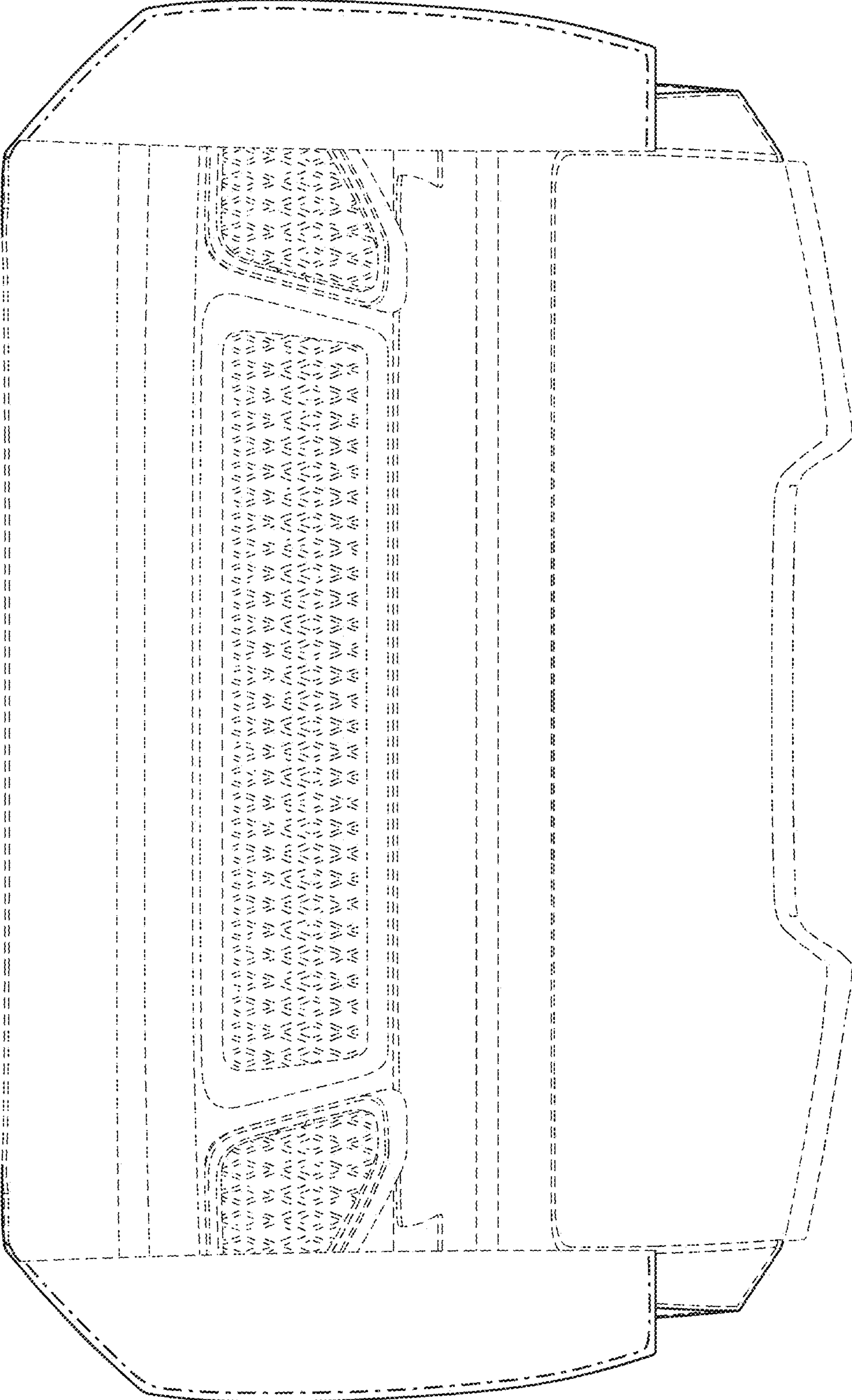

FIG. 3

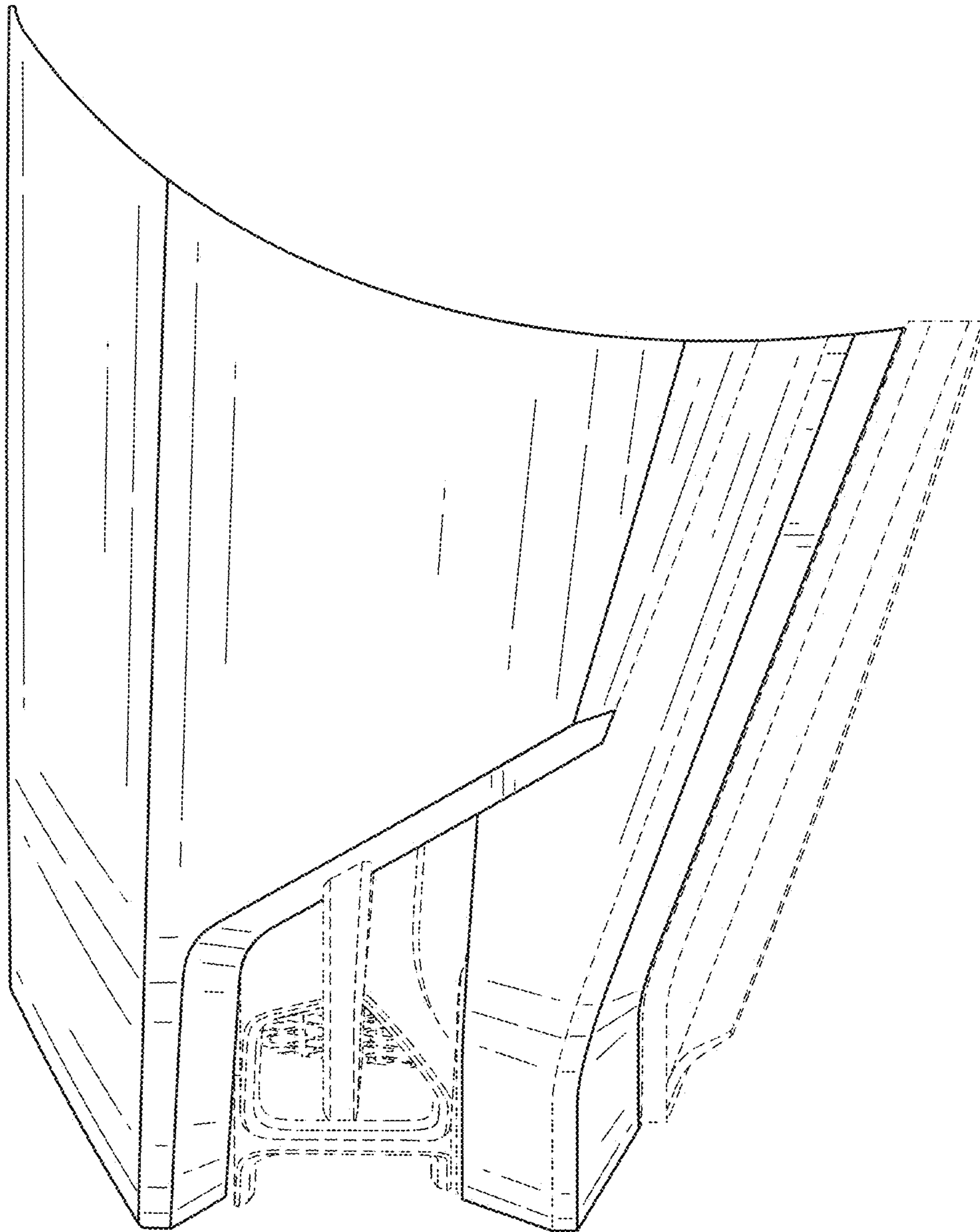

FIG. 4



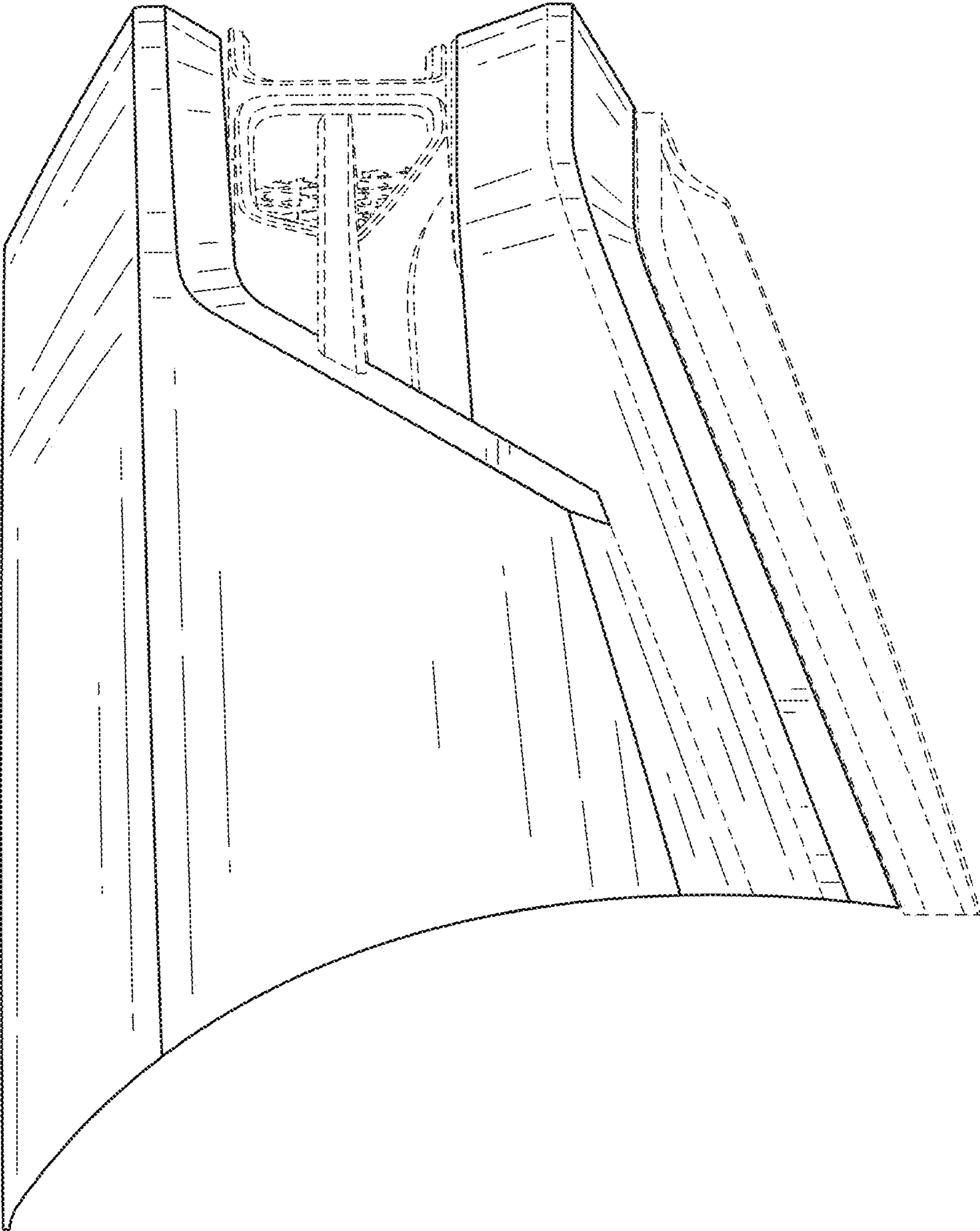

FIG. 5

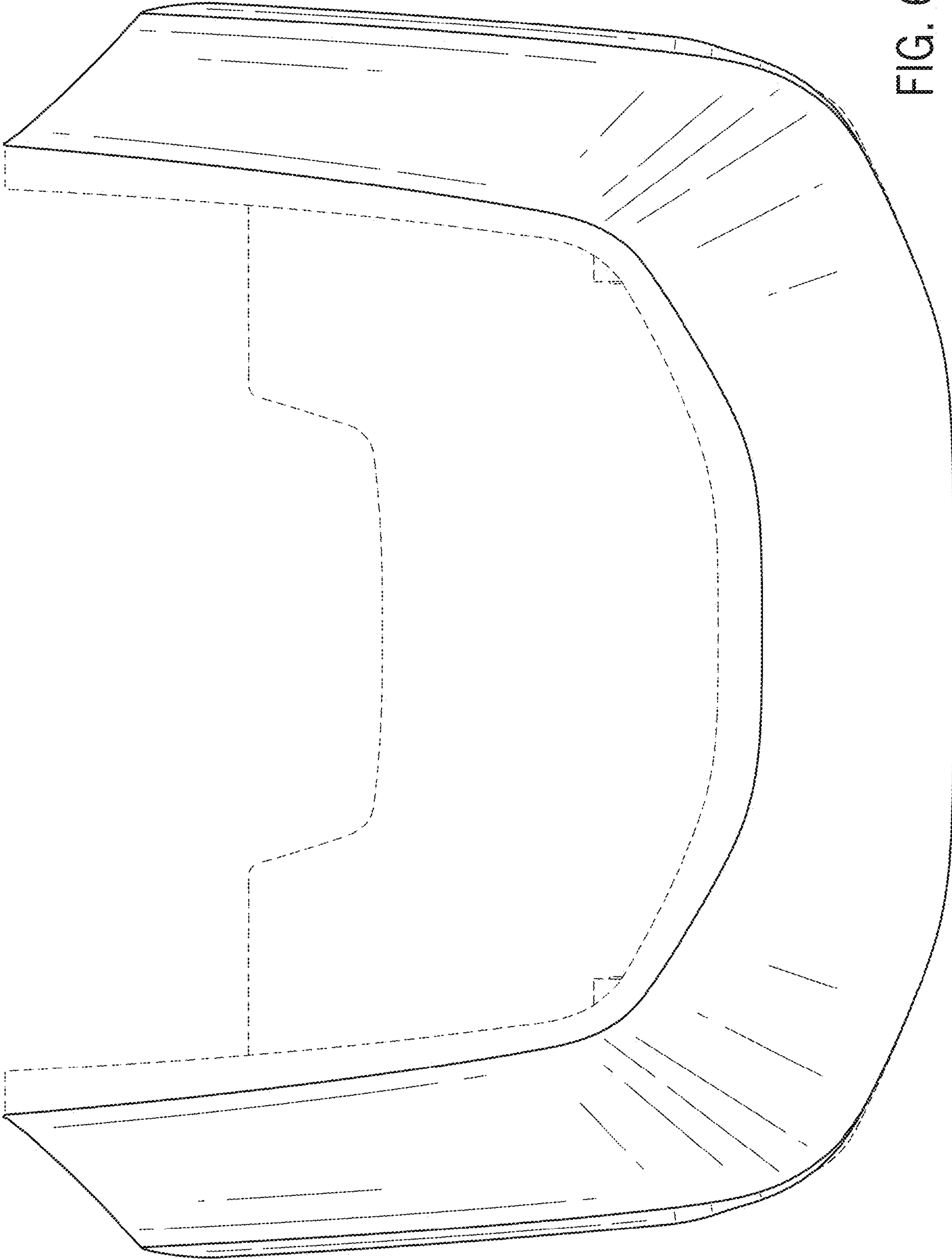
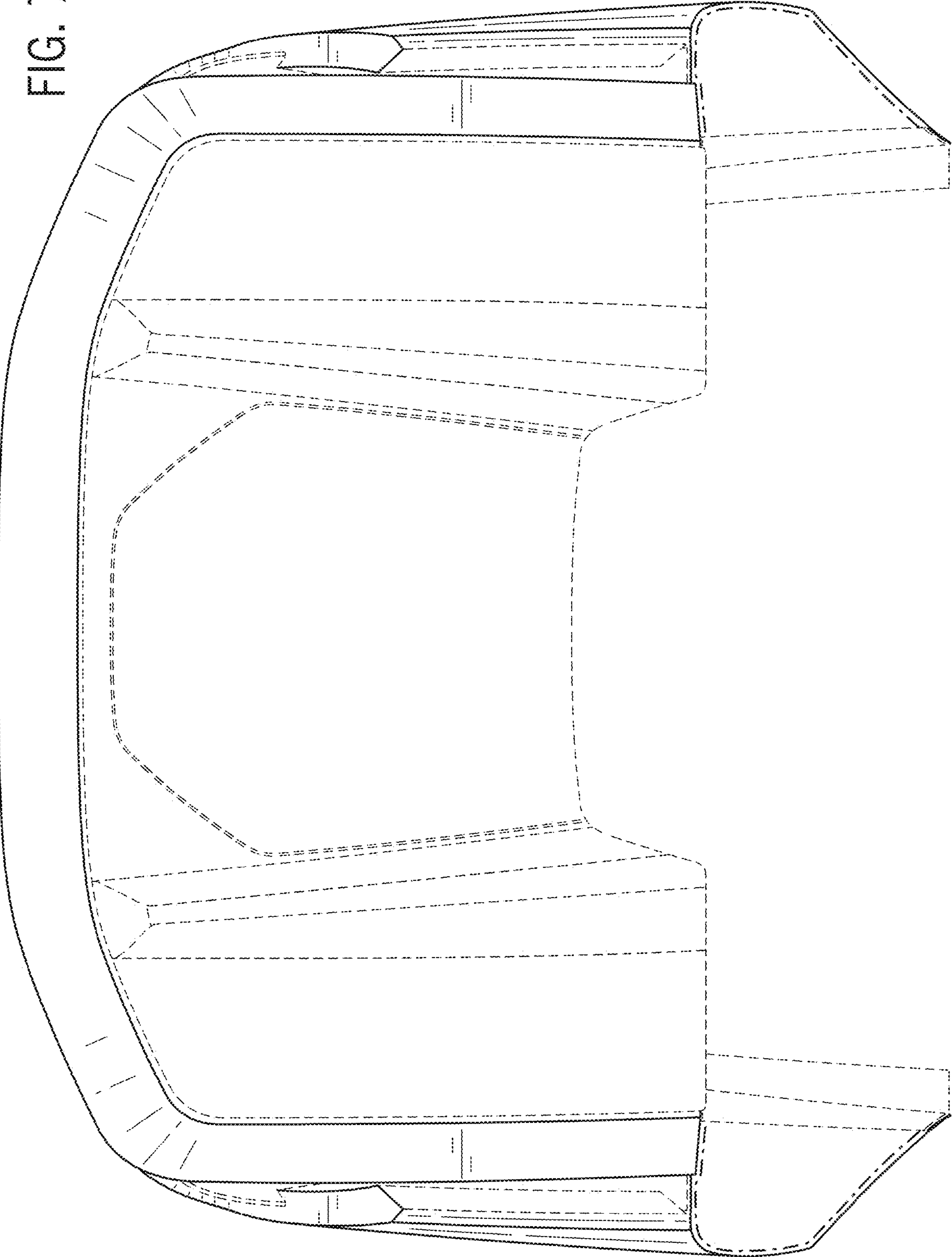

FIG. 6



FIG. 7



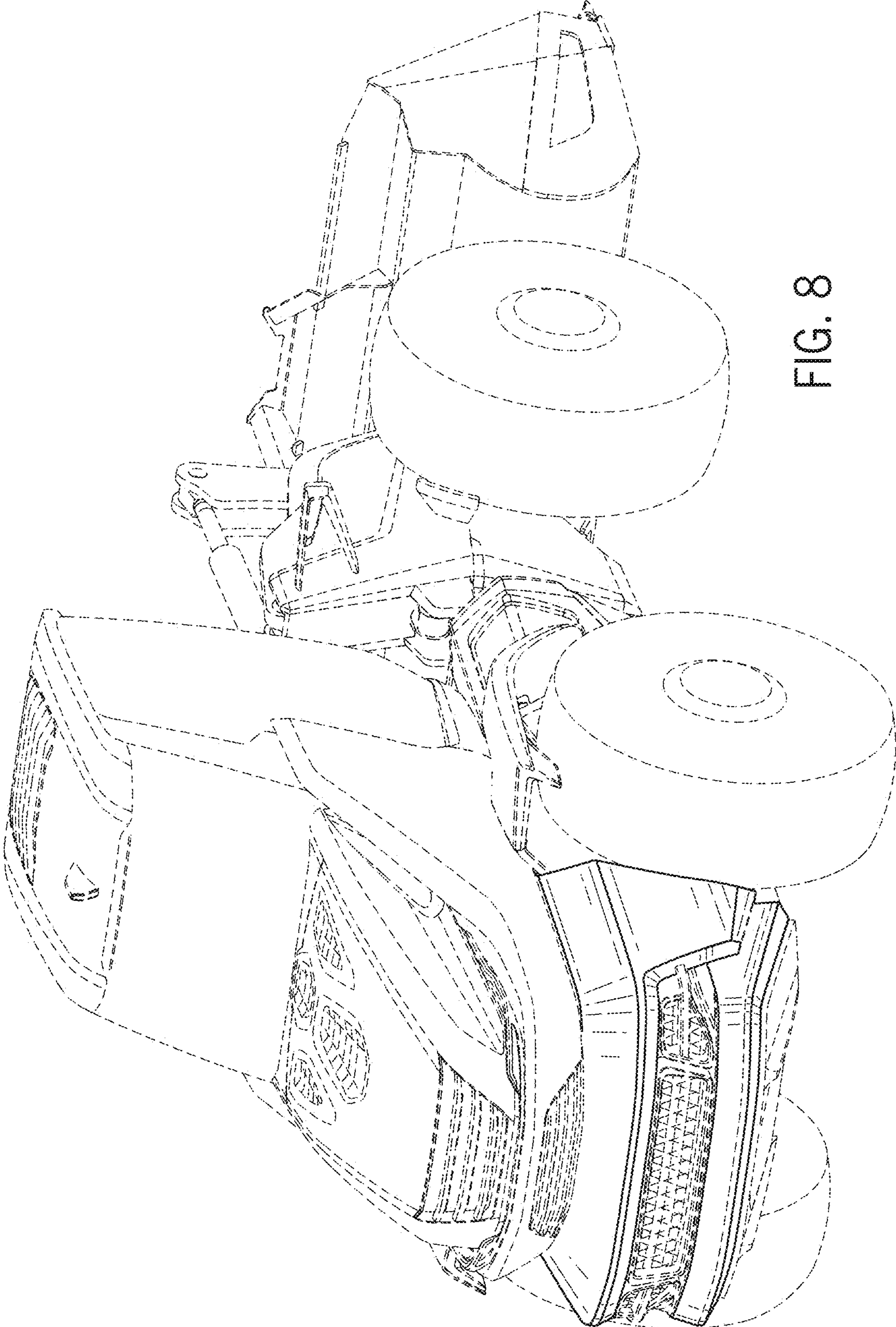

FIG. 8