



US00D954642S

(12) **United States Design Patent**
Willey et al.

(10) **Patent No.:** **US D954,642 S**
(45) **Date of Patent:** **** Jun. 14, 2022**

(54) **BATTERY PACK**

FOREIGN PATENT DOCUMENTS

(71) Applicant: **TECHTRONIC CORDLESS GP,**
Anderson, SC (US)

EP 000683503-0001 ‡ 6/2007
EP 000849468-0001 ‡ 2/2008

(Continued)

(72) Inventors: **Brent Willey,** Anderson, SC (US);
Ryan Altenburger, Greenville, SC
(US); **James Patton,** Anderson, SC
(US); **Denis Fauteux,** Tsing Yi (HK);
Raymond Lee, Shatin (HK); **Joe Zhao,**
Dongguan (CN); **JG Zhao,** Dongguan
(CN); **Jason Lishengping,** Dongguan
(CN)

OTHER PUBLICATIONS

Ryobi 130224054 Drill Battery Pack 18-volt, Ryobi, first available on Amazon.com on Mar. 26, 2013, retrieved on Apr. 16, 2018, retrieved from the Internet URL: https://www.amazon.com/Ryobi-130224054-Original-Equipment-Manufacturer/dp.B00C1KULDS/ref=sr_1_19?s=hi&ie=UTF8&qid=1523902511&sr=1-19&keywords=ryobi+battery+pack.‡

(Continued)

(73) Assignee: **TECHTRONIC CORDLESS GP,**
Anderson, SC (US)

Primary Examiner — Christy Nemeth

(**) Term: **15 Years**

(74) *Attorney, Agent, or Firm* — Michael Best & Friedrich LLP

(21) Appl. No.: **29/754,166**

(22) Filed: **Oct. 7, 2020**

Related U.S. Application Data

(62) Division of application No. 29/610,786, filed on Jul. 14, 2017, now Pat. No. Des. 911,265.

(30) **Foreign Application Priority Data**

Jan. 17, 2017 (CN) 201730018092.0

(51) **LOC (13) Cl.** **13-02**

(52) **U.S. Cl.**
USPC **D13/103**

(58) **Field of Classification Search**
USPC D13/102–110, 118, 119, 153, 154, 184,
D13/199

(Continued)

(56) **References Cited**

U.S. PATENT DOCUMENTS

D306,573 S ‡ 3/1990 Schultz D13/10
D306,574 S ‡ 3/1990 Schultz D13/10

(Continued)

(57) **CLAIM**

We claim the ornamental design for a battery pack, as shown and described.

DESCRIPTION

FIG. 1 is a perspective view of a battery pack.
FIG. 2 is a front view of the battery pack.
FIG. 3 is a rear view of the battery pack.
FIG. 4 is a left side view of the battery pack.
FIG. 5 is a right side view of the battery pack.
FIG. 6 is a top view of the battery pack; and,
FIG. 7 is a bottom view of the battery pack.
The dash-dash broken lines in the drawings are for the purpose of illustrating portions of the battery pack that form no part of the claimed design. The dash-dot broken lines in the drawings are for the purpose of illustrating a boundary and form no part of the claimed design.

1 Claim, 7 Drawing Sheets

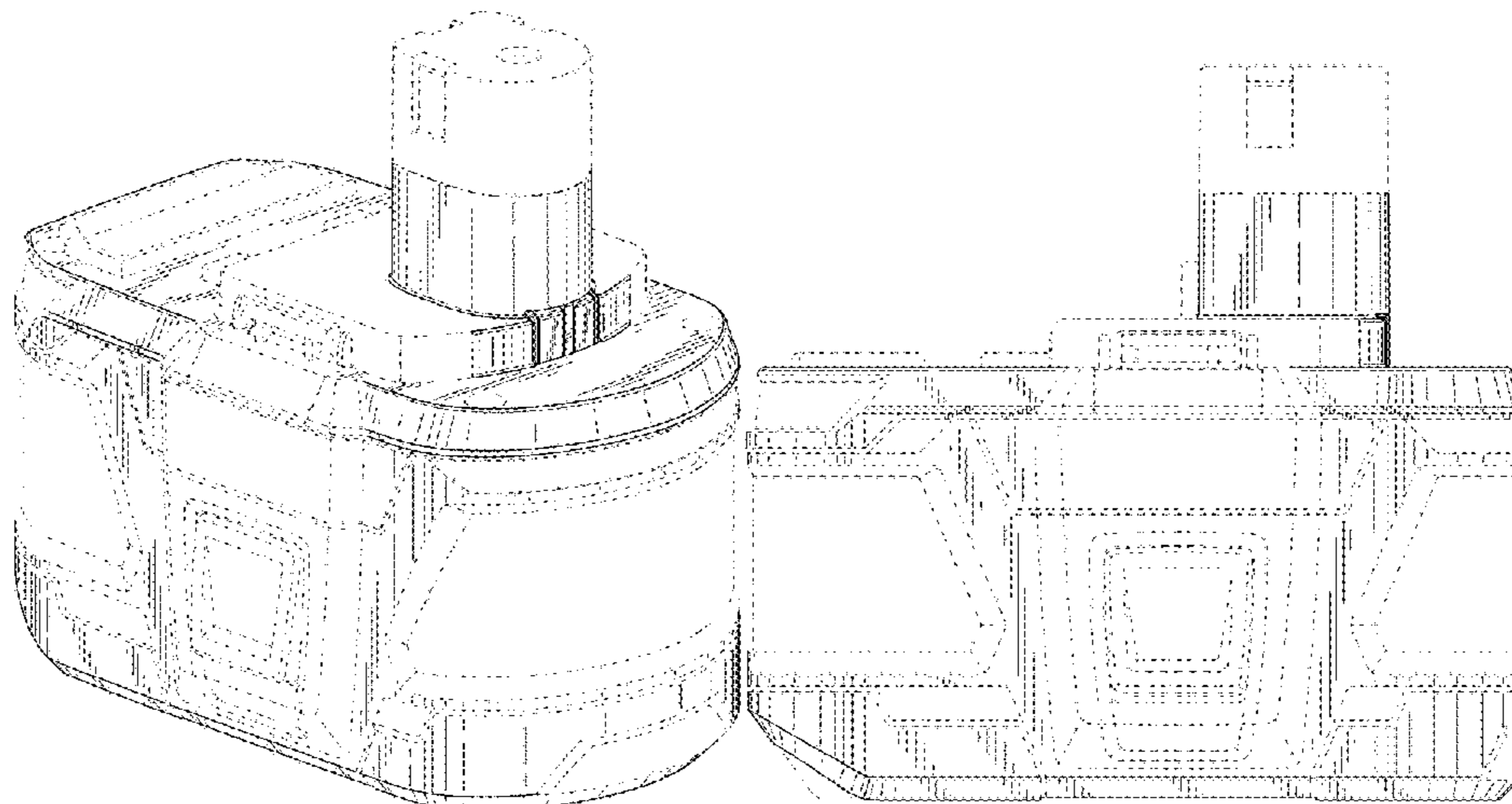

(58) **Field of Classification Search**

CPC Y02E 60/10; Y02E 60/12; Y02E 60/122;
 Y02E 60/124; Y02E 60/50; H01M 2/02;
 H01M 2/022; H01M 2/0202; H01M
 2/0207; H01M 2/0212; H01M 2/1061;
 H01M 2/1022; H01M 2/1055; H01M
 2/1066; H01M 2/105; H01M 2/20; H01M
 2/202; H01M 2/204; H01M 2/206; H01M
 2200/30; H01M 2250/30; H01M 2250/40;
 H01M 10/44; H01M 10/46; H01M
 10/465; H01M 10/482; H01M 10/4257;
 H01M 10/0436; H01M 10/48; H02J
 7/0034; H02J 7/0054; H02J 7/1423; H02J
 7/00; H02J 7/0003; H02J 7/0011; H02J
 7/0013; H02J 7/0055; H02J 7/0057;
 Y02T 10/7005; Y02T 10/705; Y02T
 10/7088

See application file for complete search history.

(56) **References Cited**

U.S. PATENT DOCUMENTS

D320,918 S † 10/1991 Mochida D8/68
 D321,338 S † 11/1991 Sakamoto D13/103
 D323,642 S † 2/1992 Liao D13/103
 D342,479 S † 12/1993 Kimata D13/10
 D345,727 S † 4/1994 Flowers D13/103
 D350,111 S † 8/1994 Okumura D13/10
 D378,654 S † 4/1997 Matsuoka D8/69
 D383,435 S † 9/1997 Svetlik D13/103
 D384,639 S † 10/1997 Kawakami D13/103
 5,783,998 A † 7/1998 Nakajou H01M 10/425
 340/63
 D397,991 S † 9/1998 Kawakami D13/10
 D412,485 S † 8/1999 Kato D13/10
 D417,648 S † 12/1999 Clowers D13/103
 6,007,939 A † 12/1999 Clowers B25F 5/00
 429/100
 D432,077 S † 10/2000 Zurwelle D13/10
 D435,013 S † 12/2000 Clowers D13/10
 D436,917 S † 1/2001 Hayakawa D13/10
 D442,452 S † 5/2001 Stirm D8/67
 6,357,533 B1 † 3/2002 Buchholz B25F 5/02
 173/21
 D456,002 S † 4/2002 Kato D13/10
 D466,777 S † 12/2002 Watson D8/68
 D466,779 S † 12/2002 Shibata D8/68
 D466,781 S † 12/2002 Matsuoka D8/68
 D466,863 S † 12/2002 Zurwelle D13/11
 D471,865 S † 3/2003 Garvis D13/12
 D474,445 S † 5/2003 Matsuoka D13/10
 D477,811 S † 7/2003 Niwa D13/10
 D481,672 S * 11/2003 Niwa D13/103
 D483,012 S † 12/2003 Hsu D13/10
 D484,458 S † 12/2003 Garvis D13/10
 D484,850 S † 1/2004 Johnson D13/10
 D487,426 S † 3/2004 Johnson D13/11
 D488,774 S † 4/2004 Zufall D13/103
 D491,438 S † 6/2004 Cheung D8/68
 D502,377 S † 3/2005 Aglassinger D8/69
 D504,111 S † 4/2005 Ozawa D13/10
 D504,394 S * 4/2005 Cheung D13/103
 6,913,087 B1 † 7/2005 Brotto B25B 21/00
 173/1
 D508,643 S † 8/2005 Concari D8/68
 D510,317 S † 10/2005 Sun 429/16
 D511,744 S † 11/2005 Hsu D13/10
 D512,373 S † 12/2005 Tsai D13/10
 D512,961 S † 12/2005 Okuda D13/10
 6,971,456 B2 † 12/2005 Yamada B25F 5/008
 173/16
 D513,730 S † 1/2006 Johnson D13/10
 D514,060 S † 1/2006 Wong D13/10
 D515,377 S † 2/2006 Chung D8/68

D516,504 S † 3/2006 Okuda D13/10
 D523,807 S † 6/2006 Murayama D13/10
 D525,848 S † 8/2006 Kokawa D8/68
 D527,971 S † 9/2006 Kokawa D8/68
 D528,975 S † 9/2006 Chi D13/103
 D530,270 S * 10/2006 Ozawa D13/103
 D535,537 S † 1/2007 Aglassinger D8/69
 D536,944 S † 2/2007 Tsai D8/68
 D539,221 S † 3/2007 Johnson D13/11
 D544,436 S * 6/2007 Kawahara D13/103
 D545,759 S † 7/2007 Ino D13/10
 D547,264 S † 7/2007 Kondo D13/103
 D550,152 S † 9/2007 Okuda D13/10
 7,270,910 B2 † 9/2007 Yahnker H01M 10/633
 429/62
 D553,562 S * 10/2007 Okada D13/103
 D555,086 S † 11/2007 Zhang D13/10
 D555,451 S † 11/2007 Okuda D8/69
 D556,002 S † 11/2007 Ino D8/68
 D558,670 S † 1/2008 Ritterling D13/10
 D562,228 S † 2/2008 Okada D13/10
 D565,374 S † 4/2008 Zhang D8/68
 D568,239 S * 5/2008 Okada D13/103
 D574,688 S † 8/2008 Yamamoto D8/68
 D575,224 S * 8/2008 Taniguchi D13/103
 D575,606 S † 8/2008 Okouchi D8/69
 D579,868 S * 11/2008 Harrison D13/103
 D580,351 S † 11/2008 Elsmark D13/10
 D580,353 S † 11/2008 Harrison D13/10
 D581,235 S † 11/2008 Aglassinger D8/69
 D586,639 S † 2/2009 Yamamoto D8/69
 D587,547 S † 3/2009 Aglassinger D8/69
 D588,986 S * 3/2009 Zhang D13/103
 D589,439 S * 3/2009 Van Wambeke D13/103
 D589,440 S * 3/2009 Van Wambeke D13/103
 D589,441 S * 3/2009 Van Wambeke D13/103
 7,508,171 B2 † 3/2009 Carrier H01M 10/482
 320/13
 D590,333 S * 4/2009 Price D13/103
 D592,028 S † 5/2009 Taniguchi D8/69
 D593,944 S * 6/2009 Smith D13/119
 D595,101 S † 6/2009 Bast D8/68
 D597,482 S † 8/2009 Kondo D13/103
 D597,931 S † 8/2009 Aglassinger D13/10
 D597,932 S † 8/2009 Aglassinger D13/10
 D597,933 S * 8/2009 Aglassinger D13/103
 D597,934 S * 8/2009 Aglassinger D13/103
 D597,935 S * 8/2009 Aglassinger D13/103
 D598,373 S * 8/2009 Aglassinger D13/103
 D598,844 S † 8/2009 Harrison D13/103
 D603,331 S † 11/2009 Schupp D13/103
 D604,583 S † 11/2009 Yamamoto D8/69
 D604,694 S † 11/2009 Aglassinger D13/10
 D604,695 S * 11/2009 Aglassinger D13/103
 D606,935 S * 12/2009 Murayama D13/103
 D607,814 S † 1/2010 Tsuzuki D13/10
 D610,082 S † 2/2010 Sweeney D13/10
 D610,478 S † 2/2010 Bast D10/69
 7,719,234 B2 † 5/2010 Carrier H02J 2207/20
 320/13
 7,723,952 B2 † 5/2010 Phillips H02J 7/00047
 320/11
 D622,660 S * 8/2010 Taniguchi D13/103
 D622,661 S * 8/2010 Yamada D13/103
 7,799,448 B2 † 9/2010 Cruise H01M 2/30
 429/7
 7,801,651 B2 † 9/2010 Iwers B63G 8/08
 701/21
 D628,454 S † 12/2010 Misaki D8/68
 7,868,591 B2 † 1/2011 Phillips H01M 2/1022
 320/11
 D632,646 S * 2/2011 Fitch D13/107
 D633,036 S * 2/2011 Murray D13/103
 7,953,965 B2 † 5/2011 Qin G06F 9/4401
 713/1
 D639,730 S * 6/2011 Kawase D13/103
 D640,190 S * 6/2011 Aglassinger D13/103
 D640,196 S * 6/2011 Shuang D13/119

(56)

References Cited

U.S. PATENT DOCUMENTS

2015/0185289 A1 ‡ 7/2015 Yang H02J 7/0013
324/43
2015/0214758 A1 ‡ 7/2015 Toya H02J 7/007
320/11
2015/0280457 A1 ‡ 10/2015 Jung H02J 7/00047
320/10
2016/0072106 A1 * 3/2016 Baumgartner H02J 7/00
320/113
2017/0271632 A1 ‡ 9/2017 Jenkins B25F 5/02
2017/0271645 A1 9/2017 Brush et al.
2018/0069208 A1 * 3/2018 Rejman B25F 5/02
2018/0198292 A1 * 7/2018 Lee H01M 10/46
2018/0198293 A1 * 7/2018 Osborne H01M 10/441
2019/0280262 A1 9/2019 Willey et al.
2019/0312242 A1 * 10/2019 Barton H02J 7/0045
2020/0042753 A1 2/2020 Huggins et al.
2020/0044209 A1 2/2020 Huggins et al.
2020/0127339 A1 * 4/2020 Nakano H01M 10/0445
2020/0176731 A1 * 6/2020 Taga H01M 10/482
2020/0227695 A1 * 7/2020 Jones H01M 50/20
2020/0321576 A1 * 10/2020 Nagahama H01M 50/213
2021/0083237 A1 * 3/2021 Cherry H01M 50/24
2021/0143506 A1 * 5/2021 Bhuiyan H01M 50/284
2021/0305661 A1 * 9/2021 Gyoda H01M 50/284
2021/0328280 A1 * 10/2021 Cruise H01M 10/486

FOREIGN PATENT DOCUMENTS

EP 001065411-0001 ‡ 1/2009
EP 001074371-0004 ‡ 4/2009
EP 001193213-0001 ‡ 2/2010
EP 001250559-0001 ‡ 12/2010

EP 001916305-0001 ‡ 9/2011
EP 002229716-0001 ‡ 5/2013
EP 002239004-0001 ‡ 5/2013
EP 002239004-0002 ‡ 5/2013
EP 001392856-0001 ‡ 1/2014
EP 002551820-0001 ‡ 12/2014
EP 002674523-0001 ‡ 4/2015
EP 002728105-0001 ‡ 7/2015
EP 002513614-0001 ‡ 9/2015
EP 002513614-0004 ‡ 9/2015
EP 002773457-0001 ‡ 10/2015
EP 002779694-0001 ‡ 10/2015
EP 003027432-0001 ‡ 3/2016
EP 003073840-0001 ‡ 5/2016
EP 003073840-0002 ‡ 5/2016
EP 003119973-0004 ‡ 5/2016
EP 003119973-0005 ‡ 5/2016
WO 2015061370 A1 4/2015
WO WO-2015061370 ‡ 4/2015

OTHER PUBLICATIONS

Ryobi 18 Volt Compact Lithium Ion 1.5 Ah Battery, <https://www.amazon.com/Ryobi-P107-Compact-Lithium-Battery/dp/B00AV250JS/ref=sr_1_4?s=power-hand-tool&ie=UTF8&qid=1511132965&sr=1-4&keywords=ryobi+18v+batt> Ryobi, first available on amazon.com Dec. 31, 2012. ‡
Ryobi, 18-Volt One+ Lithium-Ion 4.0 Ah Lithium+ HP High Capacity Battery, review on Apr. 8, 2018, retrieved on Jun. 24, 2020, from the internet URL: <<https://www.homedepot.com/p/RYOBI-18-Volt-ONE-Lithium-In-4-0-Ah-Lithium-HP-High-Capacity-Battery-P192/301913865>>.

* cited by examiner
‡ imported from a related application

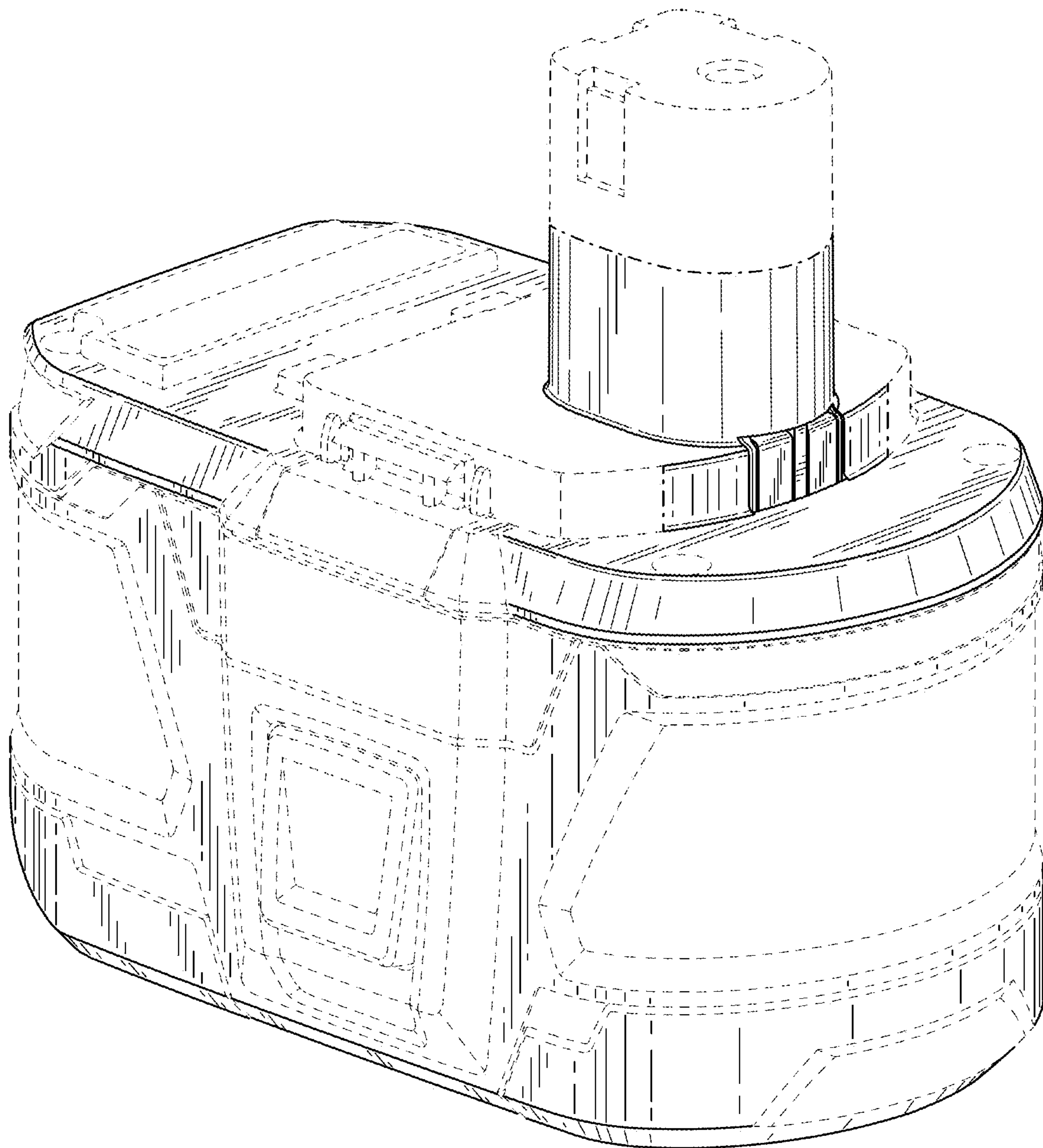

FIG. 1

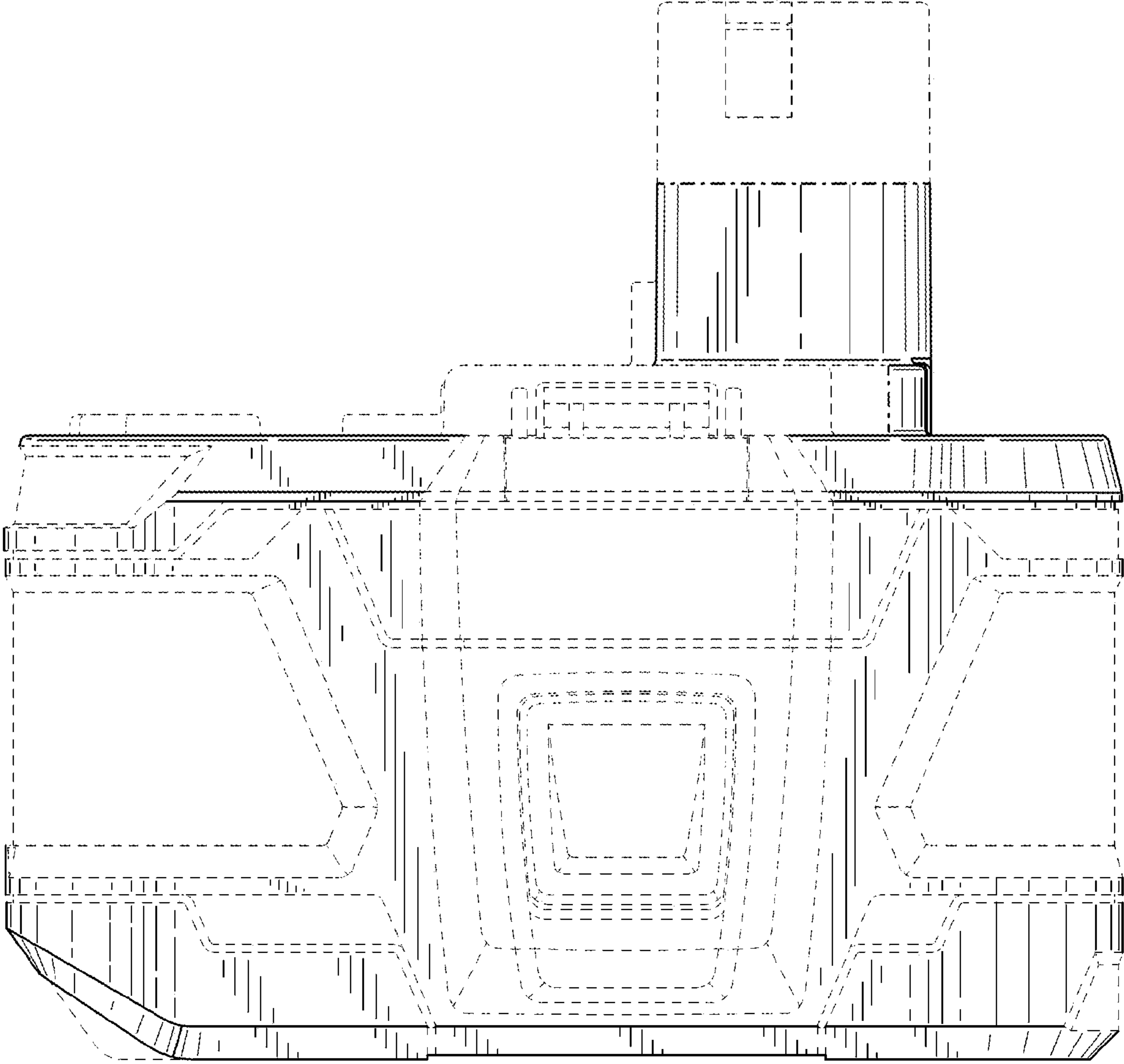

FIG. 2

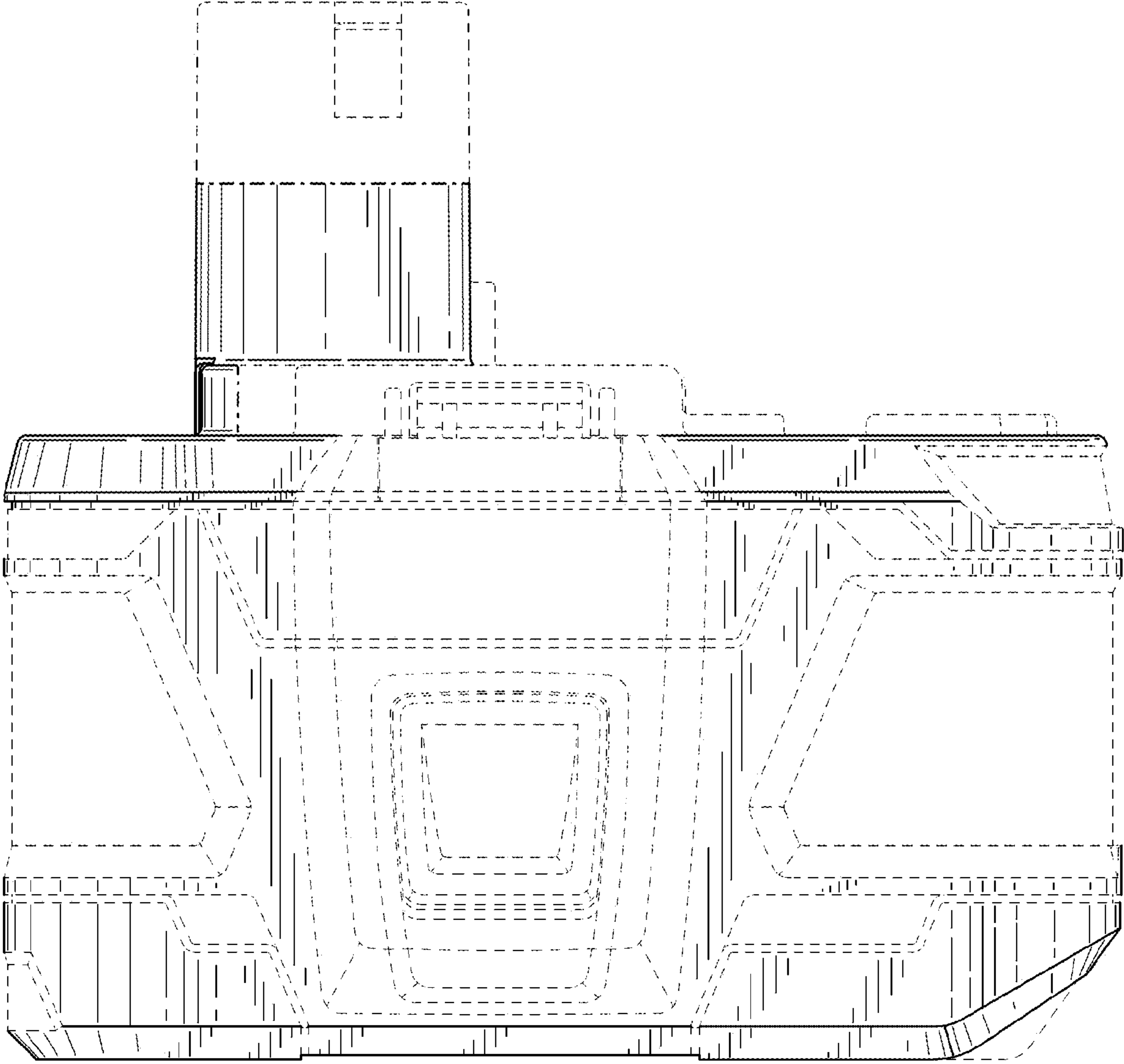

FIG. 3

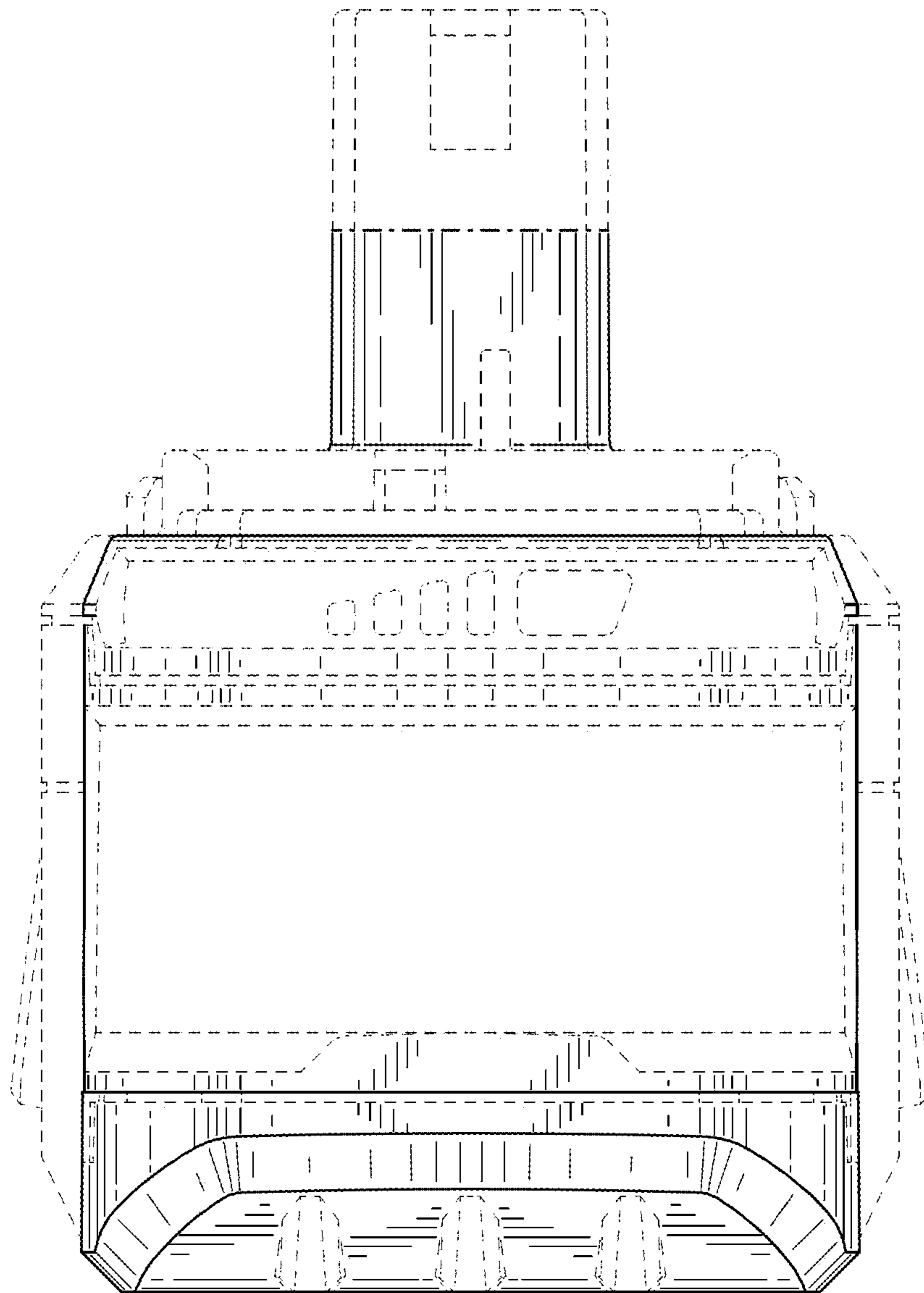

FIG. 4

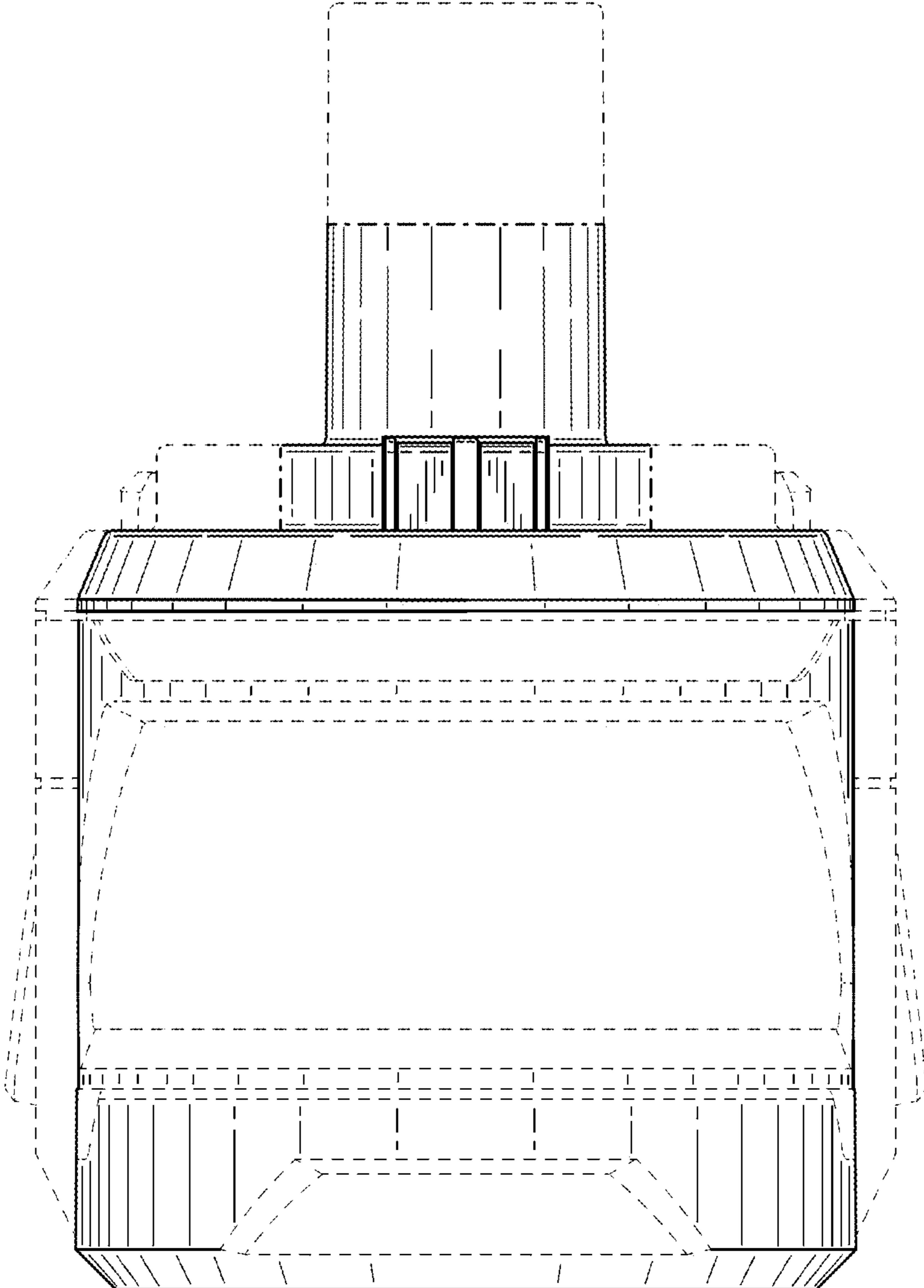

FIG. 5

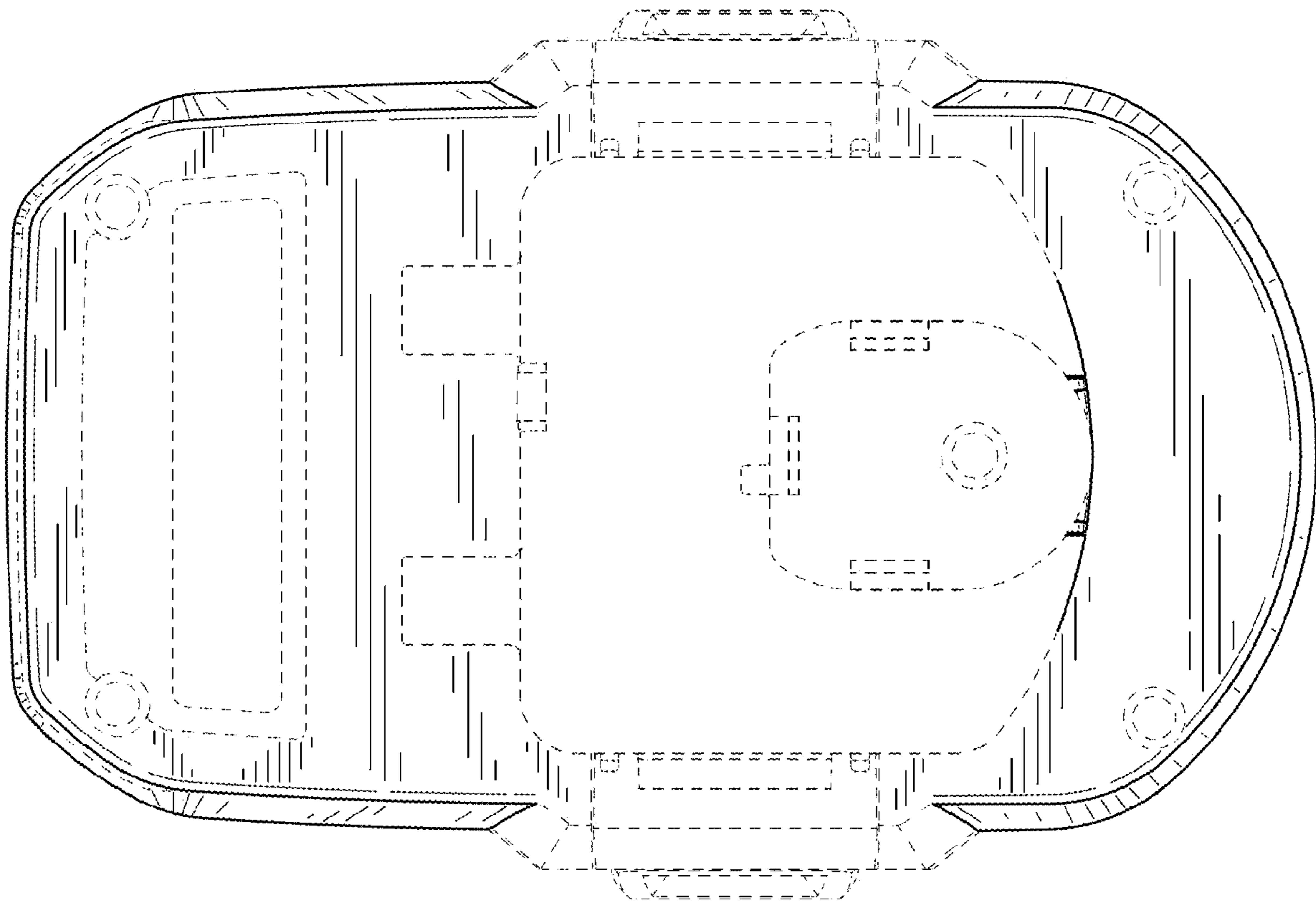

FIG. 6

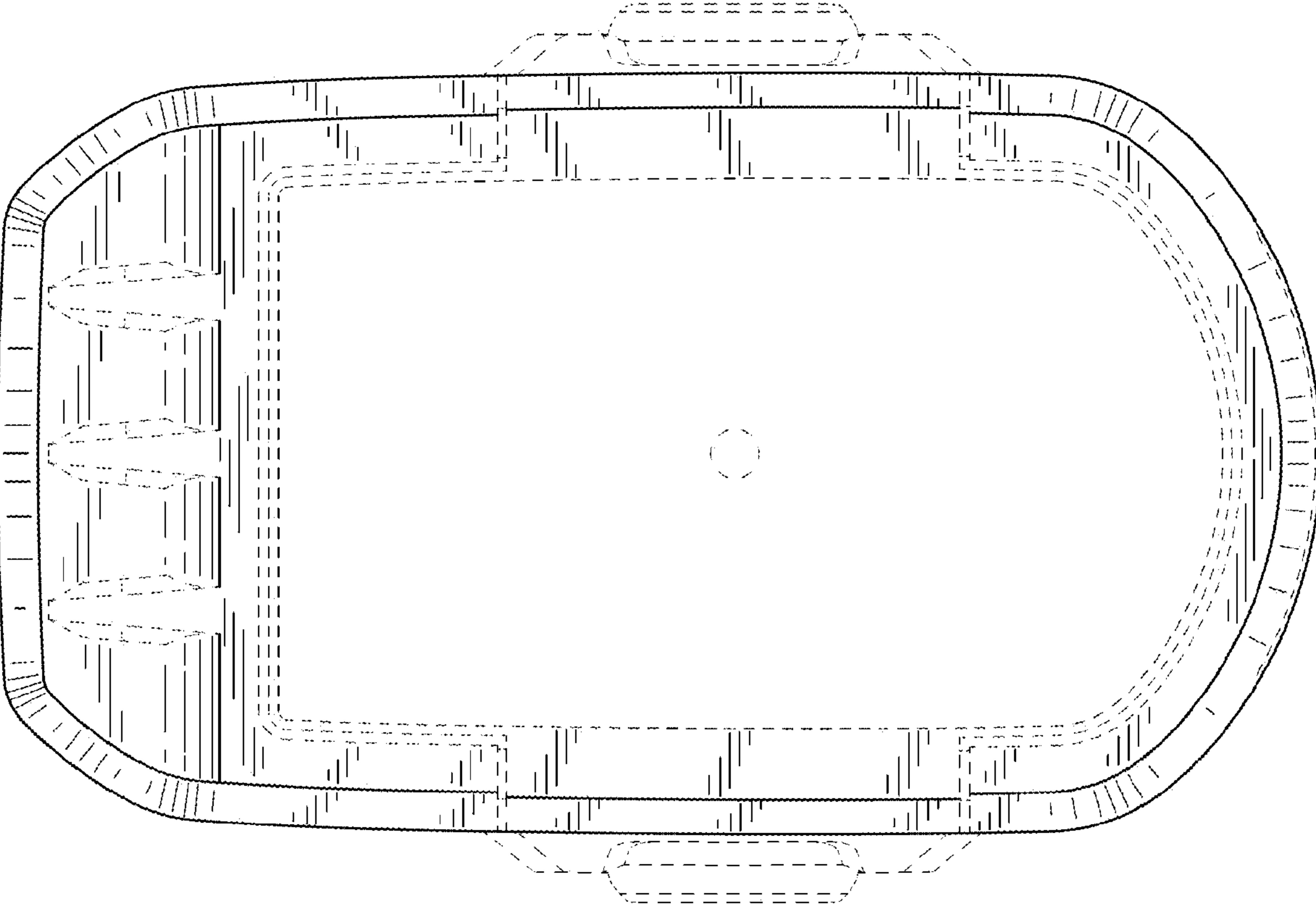

FIG. 7