



US00D954396S

(12) **United States Design Patent**
Kurzweil

(10) **Patent No.:** **US D954,396 S**
(45) **Date of Patent:** **** Jun. 14, 2022**

(54) **MALE UNDERWEAR**

(71) Applicant: **Wolfram Kurzweil**, Vienna (AT)

(72) Inventor: **Wolfram Kurzweil**, Vienna (AT)

(**) Term: **15 Years**

(21) Appl. No.: **29/752,904**

(22) Filed: **Sep. 29, 2020**

(30) **Foreign Application Priority Data**

Apr. 2, 2020 (EM) 007786751

(51) **LOC (13) Cl.** **02-01**

(52) **U.S. Cl.**
USPC **D2/712**

(58) **Field of Classification Search**

USPC D2/700, 704, 705, 712, 713, 714, 715,
D2/716, 728, 731, 732, 733, 734, 738,
D2/742, 743, 749; D24/124, 125
CPC A41B 11/14; A41B 11/143; A41B 11/146;
A41B 9/00; A41B 9/001; A41B 9/002;
A41B 9/004; A41B 9/005; A41B 9/007;
A41B 9/008; A41B 9/02; A41B 9/023;
A41B 9/026; A41B 9/04; A41B 9/06;
A41B 9/08; A41D 1/06; A41D 1/08;
A41D 1/084; A41D 7/00; A41D 7/005;
A41D 13/0015; A41D 27/24; A41D
27/245; A41D 2400/24; A41D 2400/38;
A41D 17/02

See application file for complete search history.

(56) **References Cited**

U.S. PATENT DOCUMENTS

4,059,117 A * 11/1977 Rosenfeld A41C 1/00
450/107
5,596,997 A * 1/1997 Abadi A61F 6/065
128/918

D481,196 S * 10/2003 Rocha D2/742
D564,180 S * 3/2008 Davis D2/712
D614,767 S * 4/2010 Webster D24/125
D689,668 S * 9/2013 Zaltsberg D2/705
11,229,241 B2 * 1/2022 Adams A41B 9/04
D942,119 S * 2/2022 Ibrahim D2/705
2006/0264864 A1 * 11/2006 Carstens A61F 13/505
2/407
2019/0125000 A1 * 5/2019 Silvas A41D 1/089
2020/0138647 A1 * 5/2020 Jang A61F 13/4704
2020/0178619 A1 * 6/2020 Dokas A41D 7/005
2021/0076751 A1 * 3/2021 Dubose A44B 18/0003

* cited by examiner

Primary Examiner — Jasmine Mlinarcik

(74) *Attorney, Agent, or Firm* — Millen, White, Zelano &
Branigan, PC; Ryan Pool

(57) **CLAIM**

The ornamental design for male underwear, as shown and described.

DESCRIPTION

FIG. 1 is a perspective view of the male underwear showing my new design.

FIG. 2 is a back view thereof.

FIG. 3 is a front view thereof.

FIG. 4 is a side view thereof.

FIG. 5 is another side view thereof.

FIG. 6 is top view thereof; and,

FIG. 7 is a bottom view thereof.

The broken lines in the drawings illustrate portions of the male underwear that form no part of the claimed design.

1 Claim, 7 Drawing Sheets

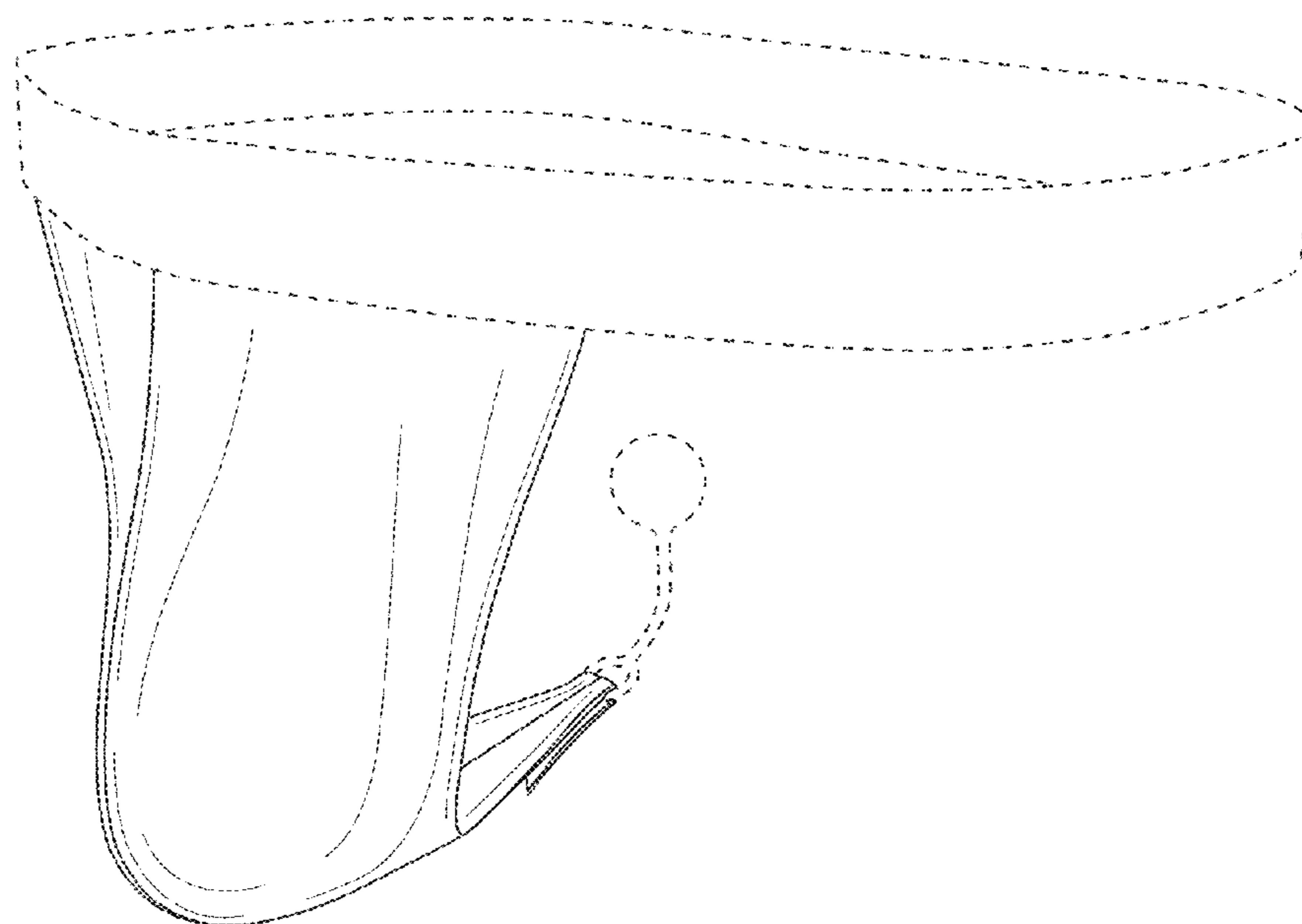

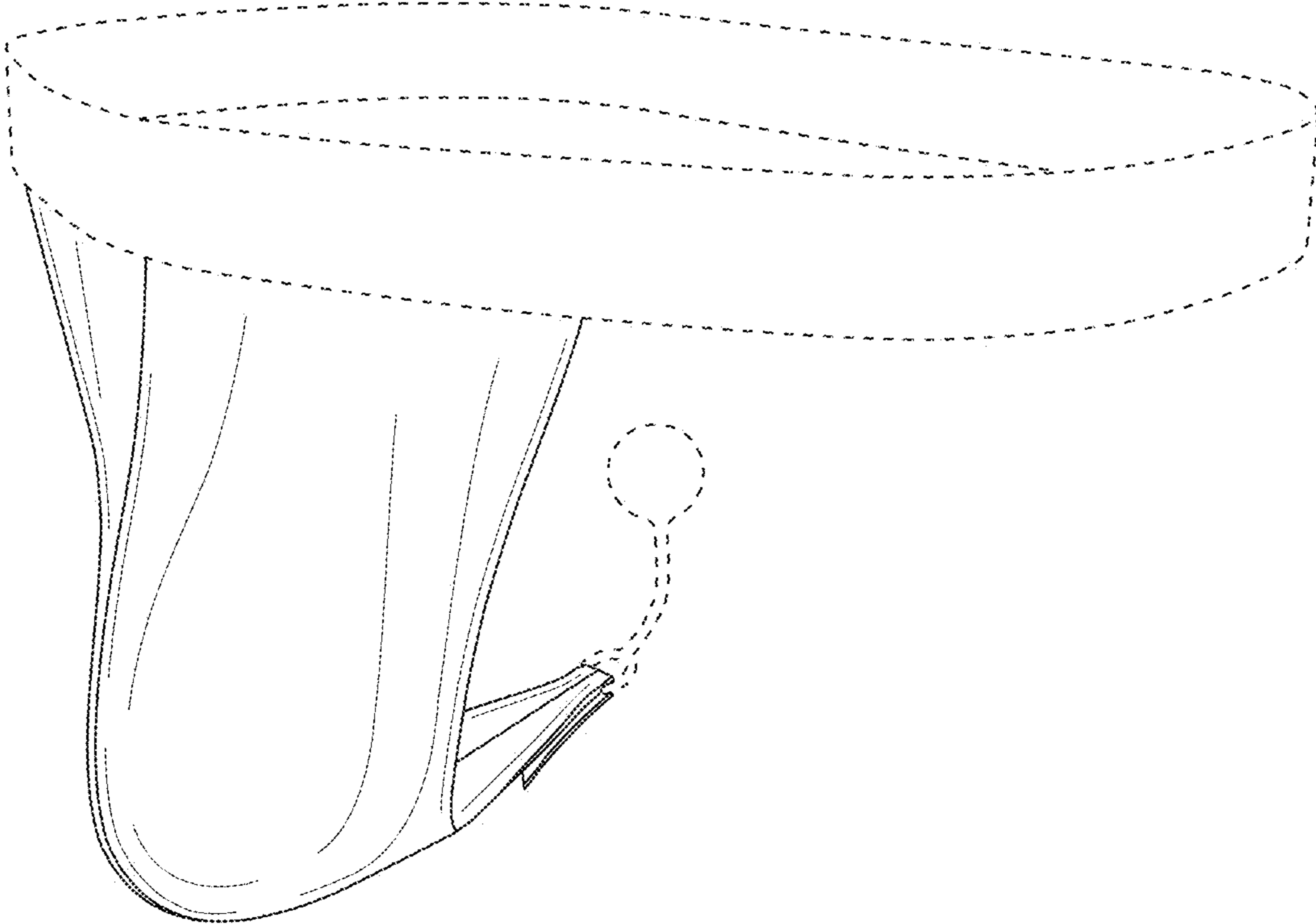

FIG. 1

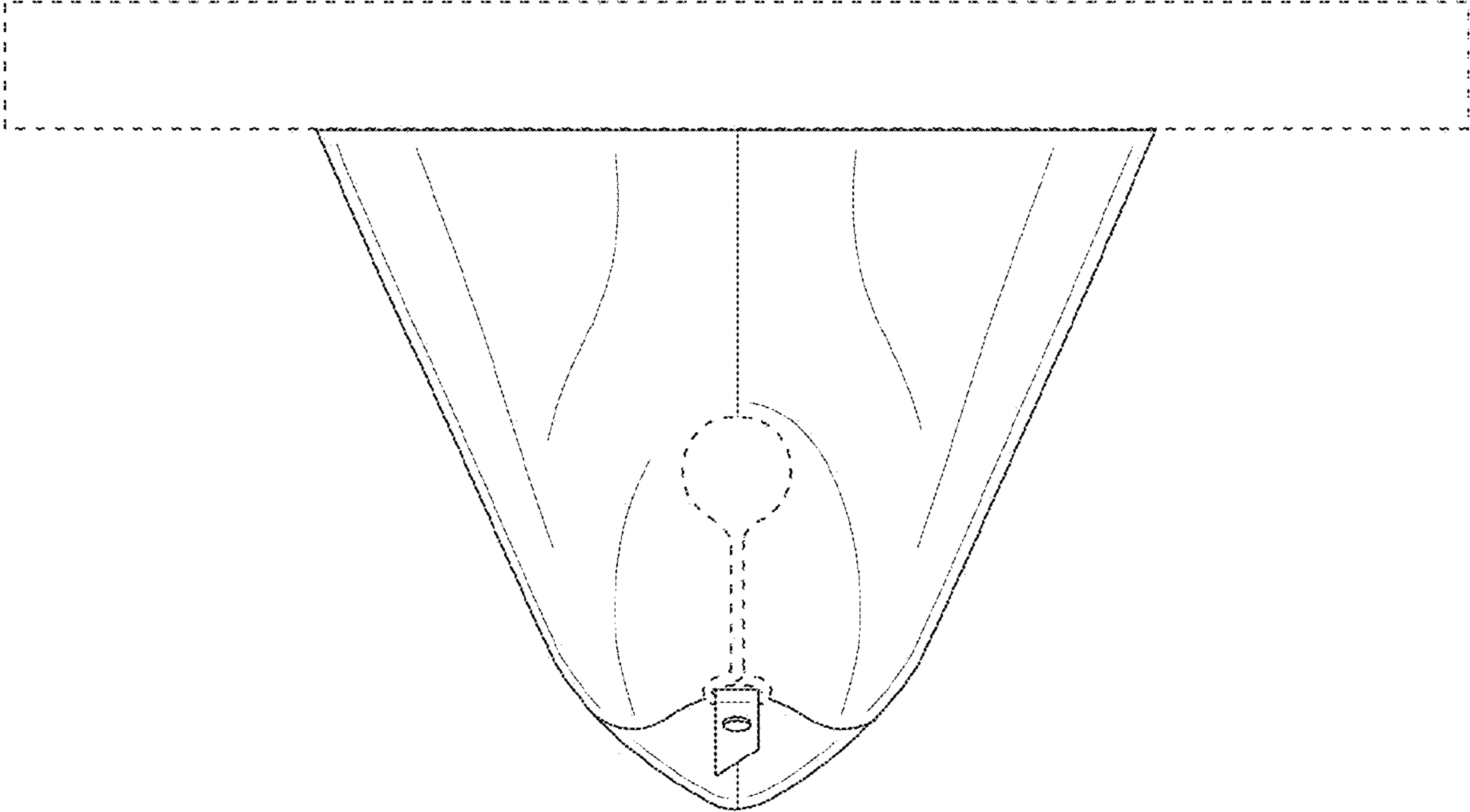

FIG. 2

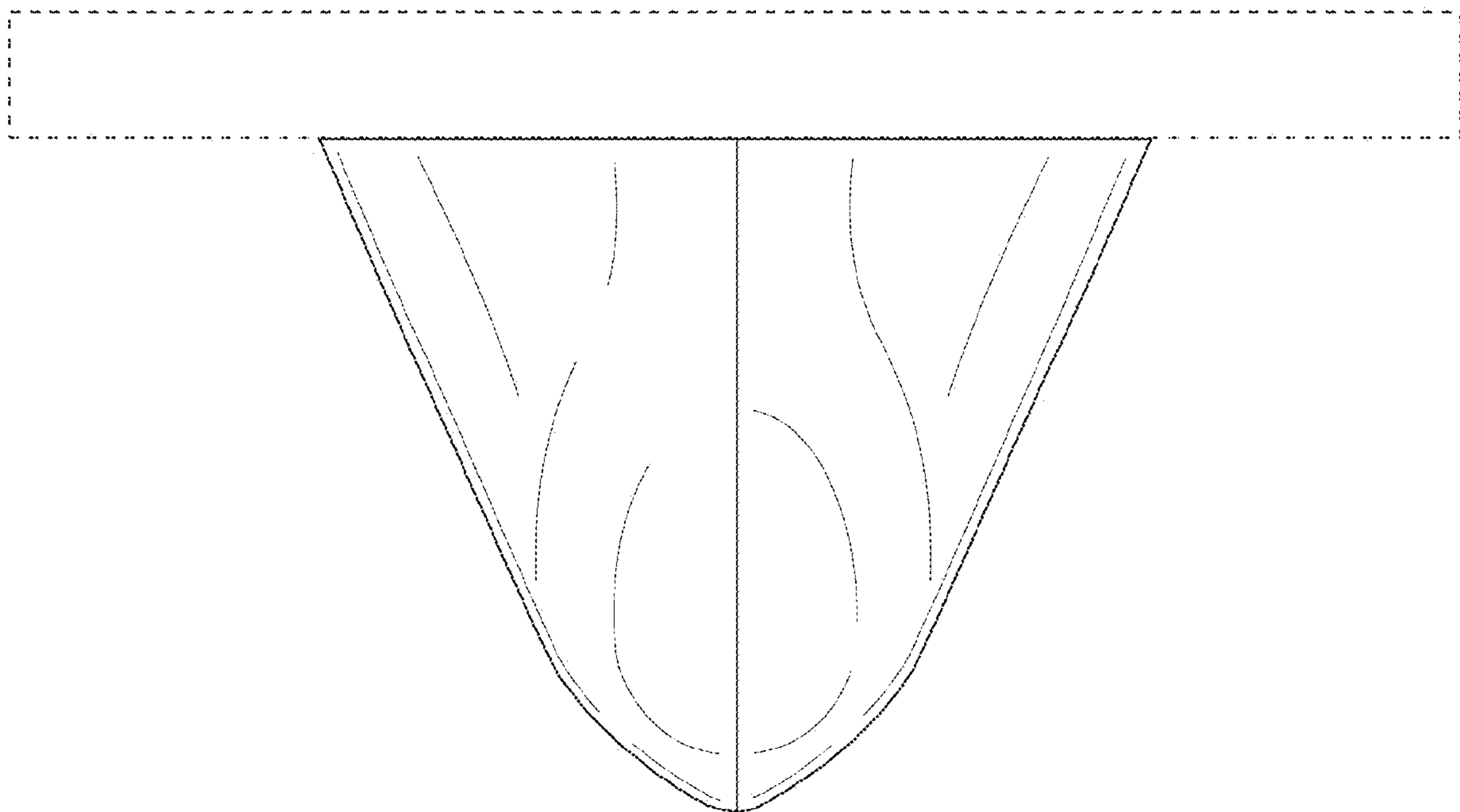

FIG. 3

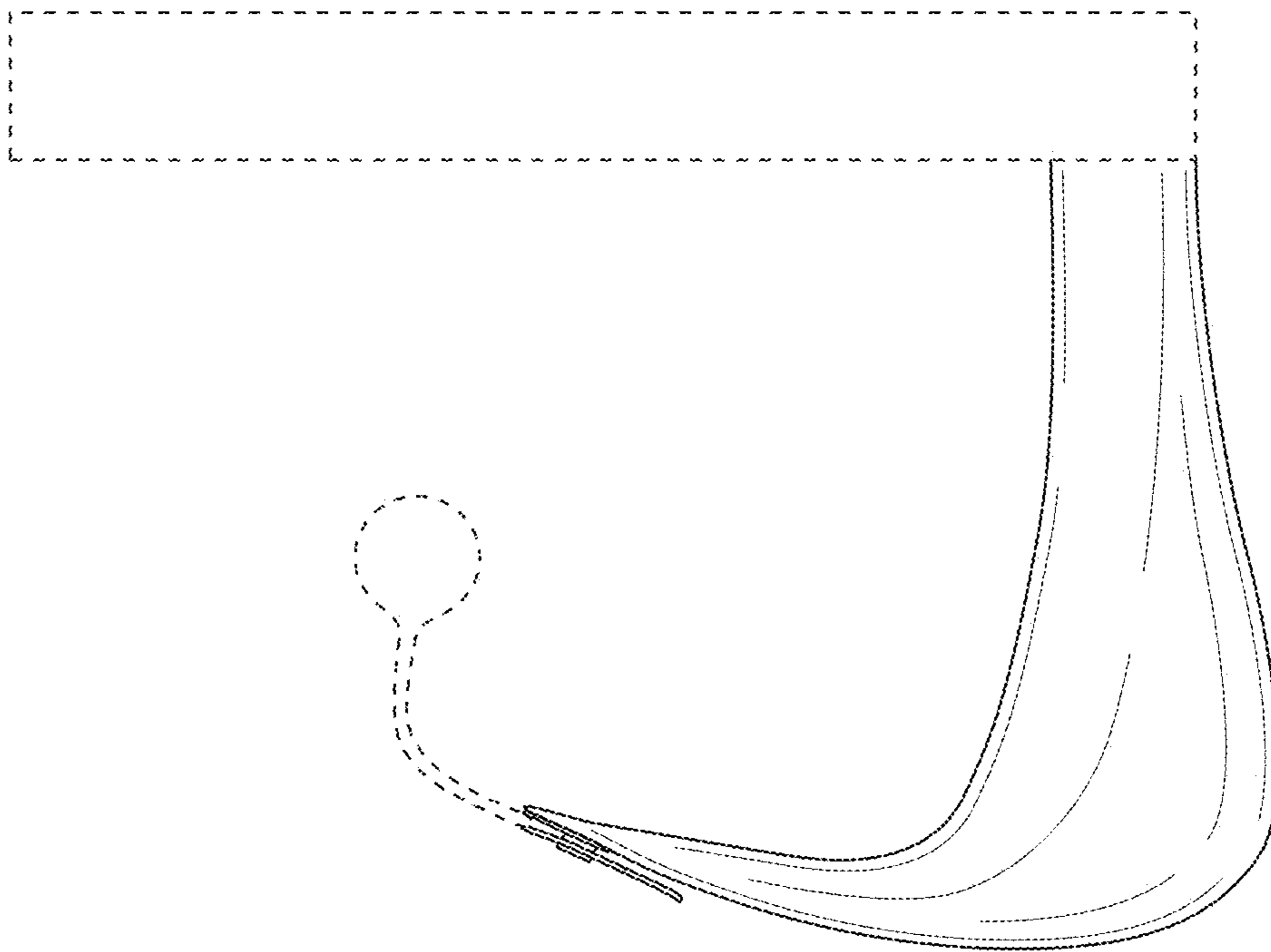

FIG. 4

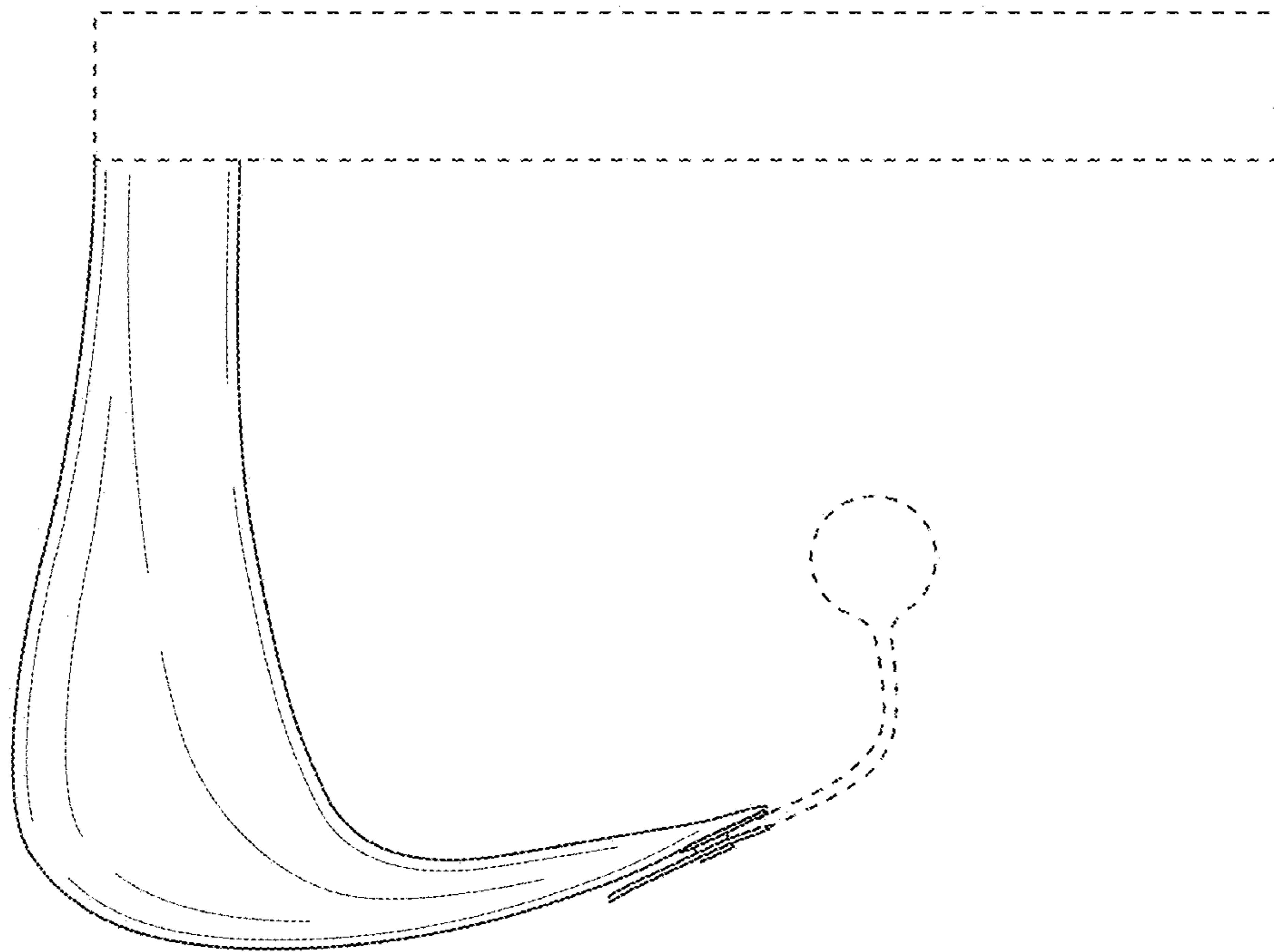

FIG. 5

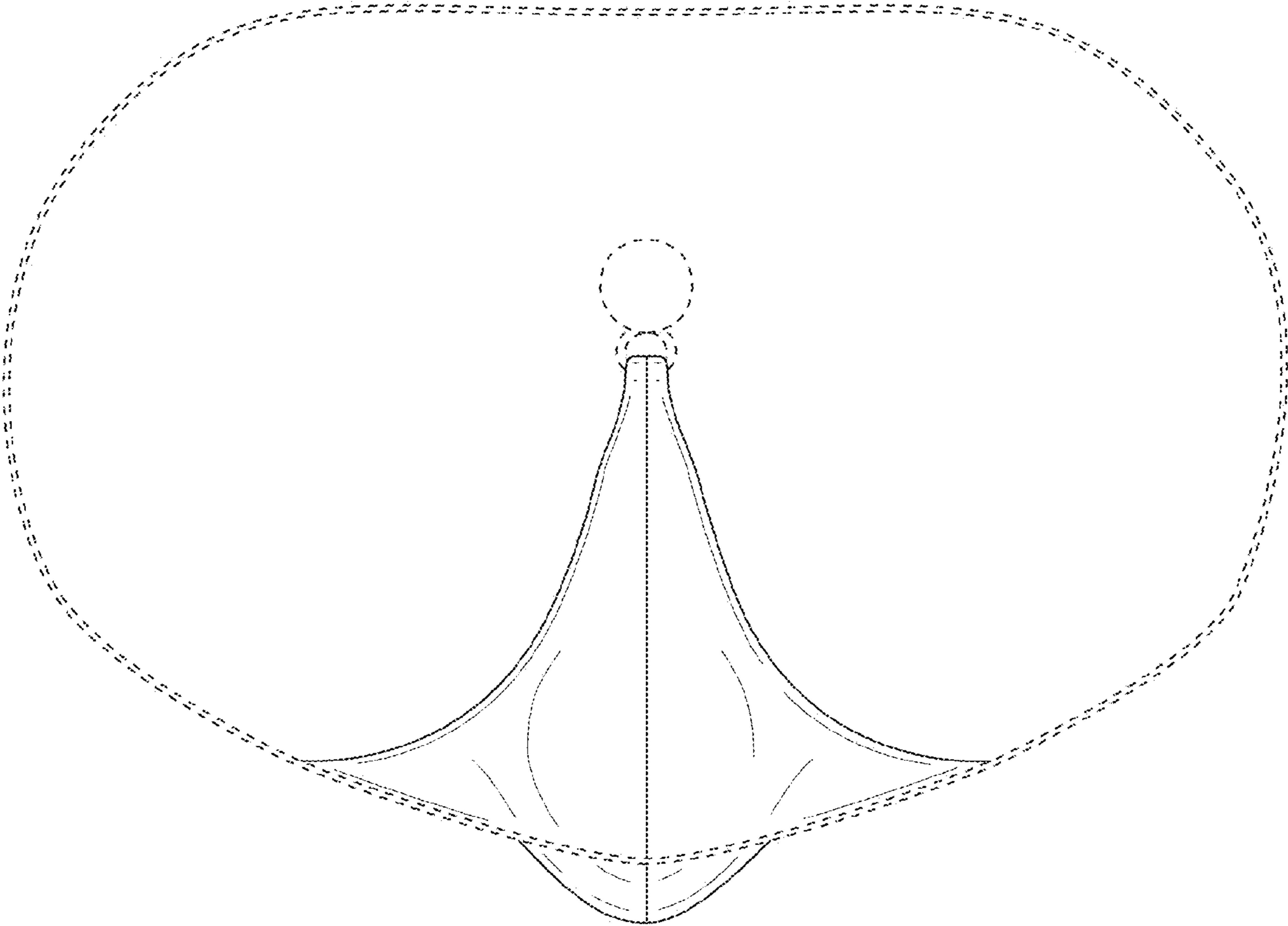

FIG. 6

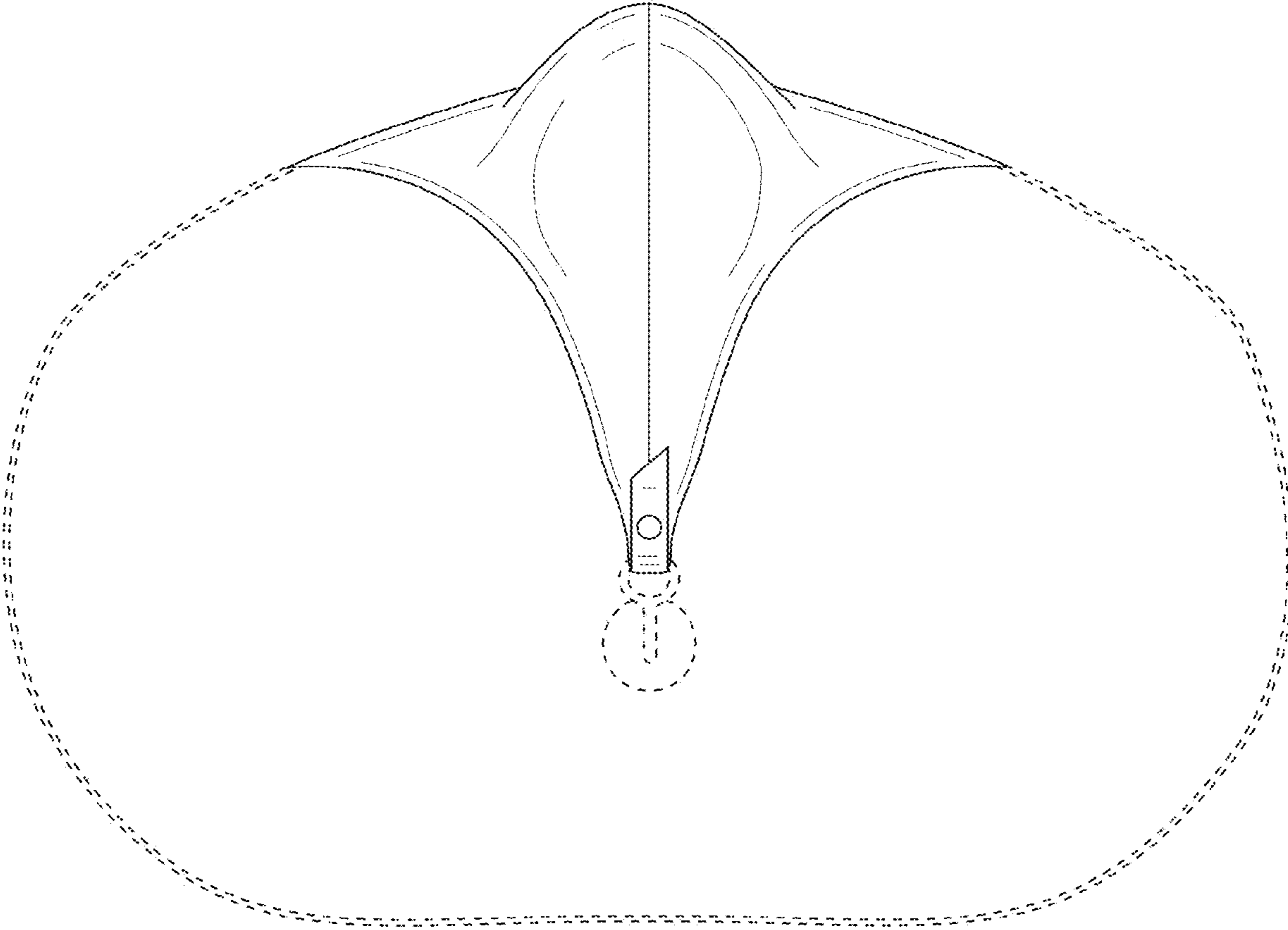

FIG. 7