



US00D954349S

(12) **United States Design Patent**  
**Hsu**

(10) **Patent No.:** **US D954,349 S**  
(45) **Date of Patent:** **\*\* Jun. 7, 2022**

- (54) **HEADBAND**
- (71) Applicant: **Lorraine Melody Hsu**, Santa Ana, CA (US)
- (72) Inventor: **Lorraine Melody Hsu**, Santa Ana, CA (US)
- (\*\*) Term: **15 Years**
- (21) Appl. No.: **29/738,114**
- (22) Filed: **Jun. 15, 2020**
- (51) **LOC (13) Cl.** ..... **28-03**
- (52) **U.S. Cl.**  
USPC ..... **D28/41**
- (58) **Field of Classification Search**  
USPC ..... D28/41, 39, 40, 42, 43, 10, 93, 99;  
D2/881, 883, 875, 877, 895  
CPC ..... A45D 8/36; A45D 8/004; A45D 8/006;  
A45D 8/14; A45D 8/00; A42C 5/02  
See application file for complete search history.

D866,928 S \* 11/2019 Aronson ..... D2/891  
D884,274 S \* 5/2020 Gerety ..... D28/41  
D897,638 S \* 10/2020 Hsu ..... D2/871

**OTHER PUBLICATIONS**

Headband By Sunshinesmile found on Amazon Sep. 27, 2021 <https://www.amazon.com/Headband-Christmas-Valentine-Halloween-Accessories/dp/B08PVCNX2D/ref=Jun.4,2021>.  
Christmas Headband Gold Stars Hair Accessory By: BellepoqueCo found on Etsy Sep. 27, 2021 [https://www.etsy.com/listing/1068522426/christmas-headband-gold-stars-hair?ga\\_order=Aug.13,2021](https://www.etsy.com/listing/1068522426/christmas-headband-gold-stars-hair?ga_order=Aug.13,2021).

\* cited by examiner

*Primary Examiner* — Rebecca Tsehaye  
(74) *Attorney, Agent, or Firm* — Bacon & Thomas, PLLC

(57) **CLAIM**

The ornamental design for a headband, as shown and described.

**DESCRIPTION**

FIG. 1 is a perspective view of a headband showing my new design;  
FIG. 2 is a front view thereof;  
FIG. 3 is a rear view thereof;  
FIG. 4 is a top view thereof;  
FIG. 5 is a bottom view thereof;  
FIG. 6 is a left side view thereof; and,  
FIG. 7 is a right side view thereof, which has been folded and secured by straps.  
The broken lines depict environment and are included for the purpose of illustrating only and form no part of the claimed design.

**1 Claim, 5 Drawing Sheets**

(56) **References Cited**

**U.S. PATENT DOCUMENTS**

- D390,341 S \* 2/1998 Levy ..... D2/869
- 6,237,611 B1 \* 5/2001 LeCrone ..... A42B 1/004  
132/275
- 6,289,903 B1 \* 9/2001 Haufler ..... A45D 8/00  
132/275
- D465,615 S \* 11/2002 Brunelle ..... A45D 44/005  
D28/99
- D465,883 S \* 11/2002 Moher ..... D28/41
- 6,513,167 B1 \* 2/2003 Cheng ..... A45D 8/36  
2/171
- D654,623 S \* 2/2012 Hsu ..... D28/41
- D722,189 S \* 2/2015 Weigl, Jr. .... D26/39
- D864,481 S \* 10/2019 Kohad ..... D28/41
- 10,441,047 B2 \* 10/2019 Egner ..... A45D 8/08

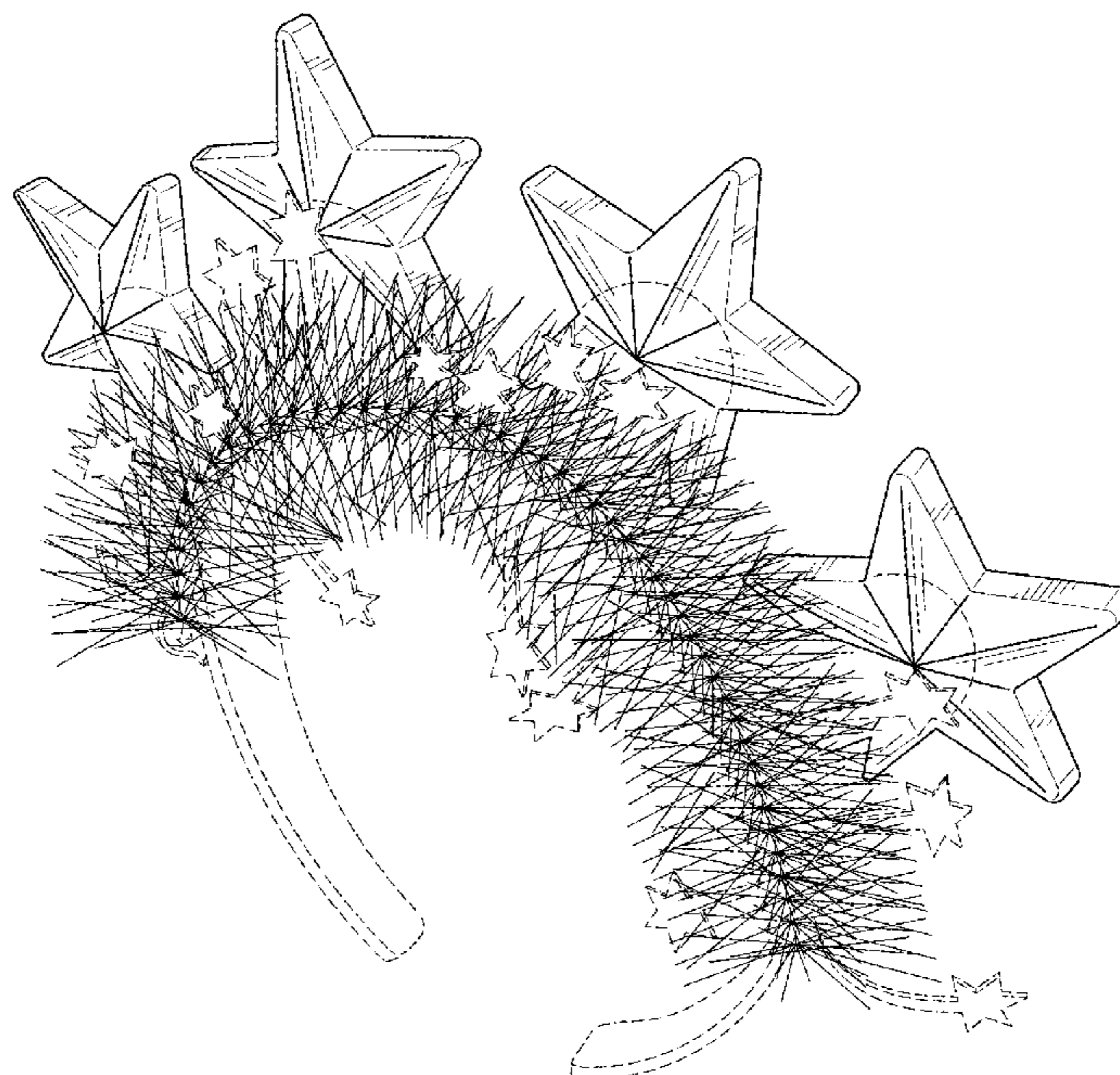

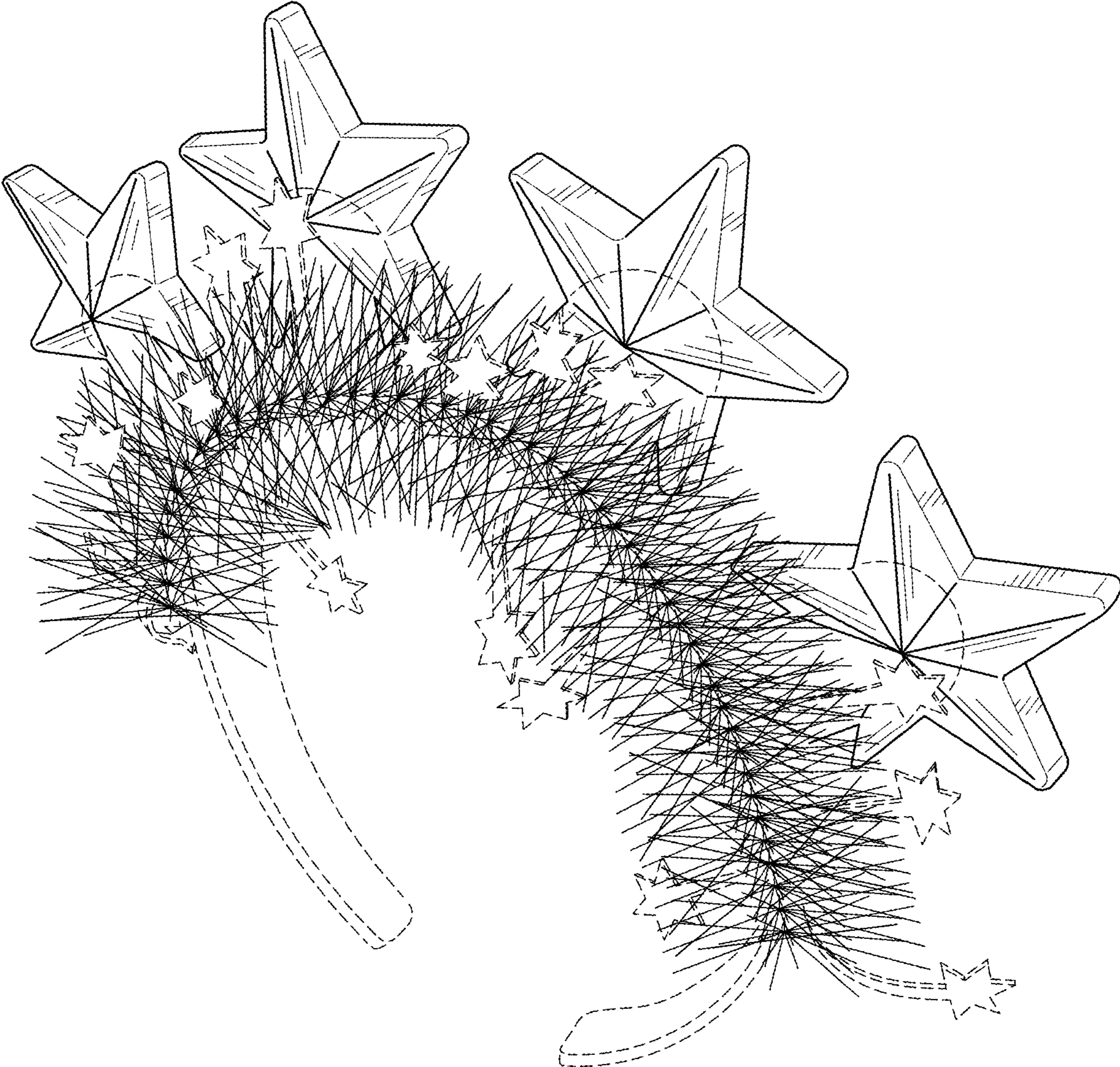

FIG. 1

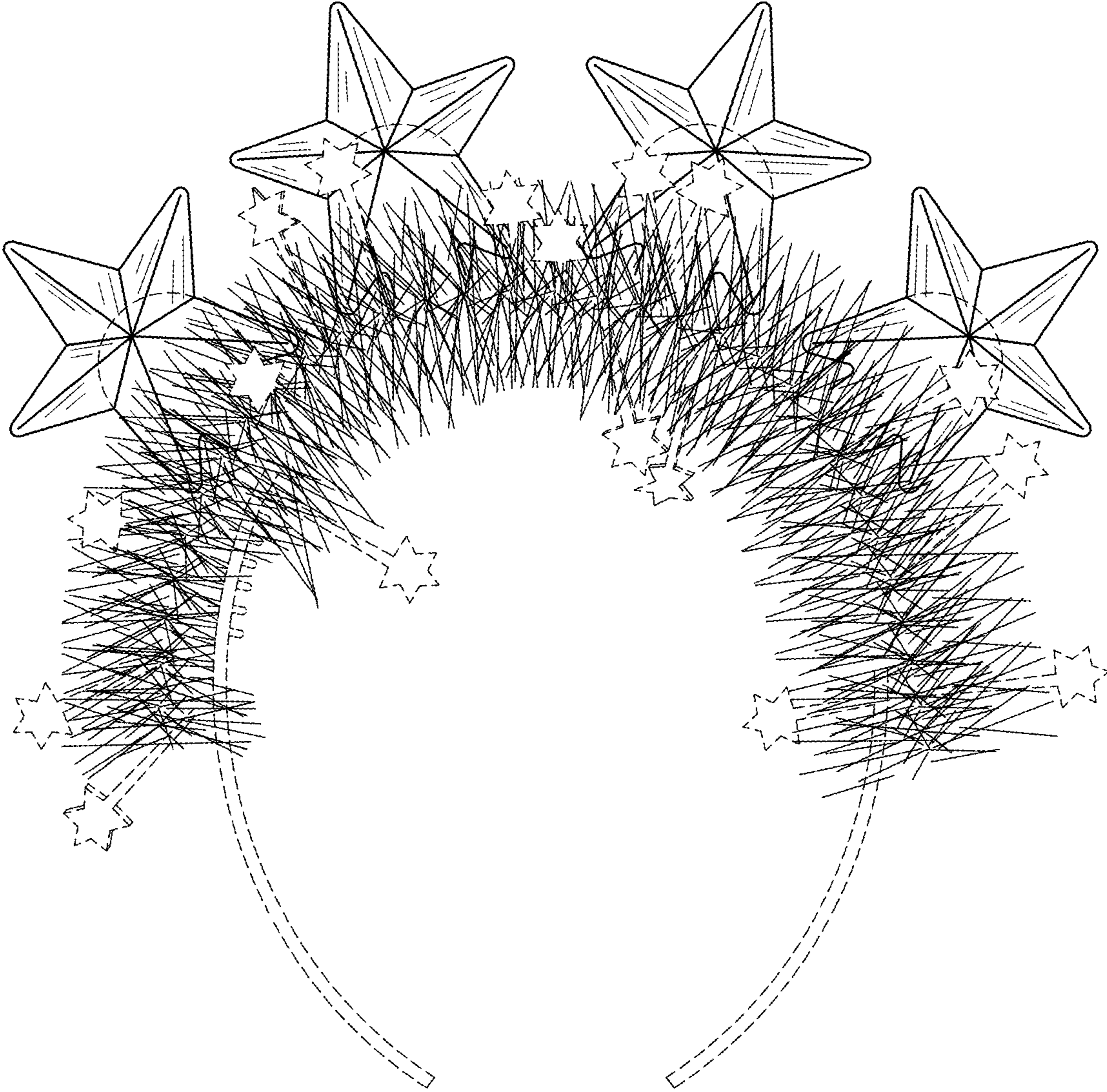

FIG. 2

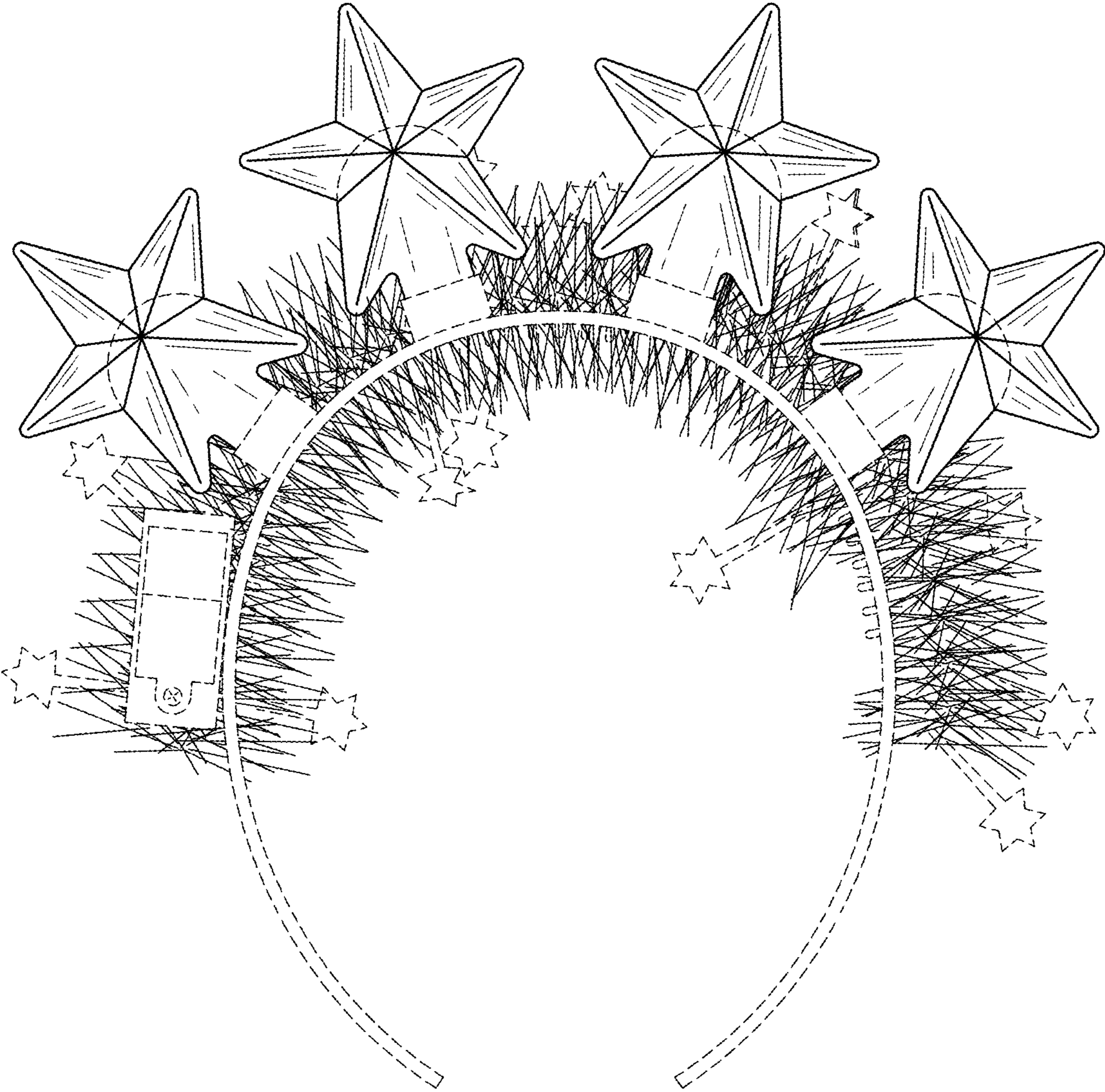

FIG. 3

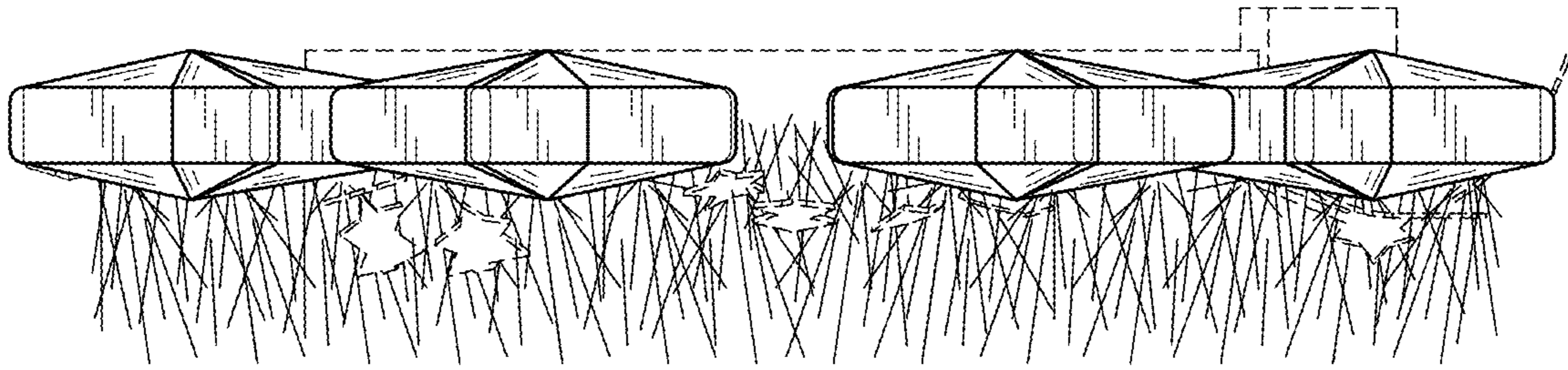

FIG. 4

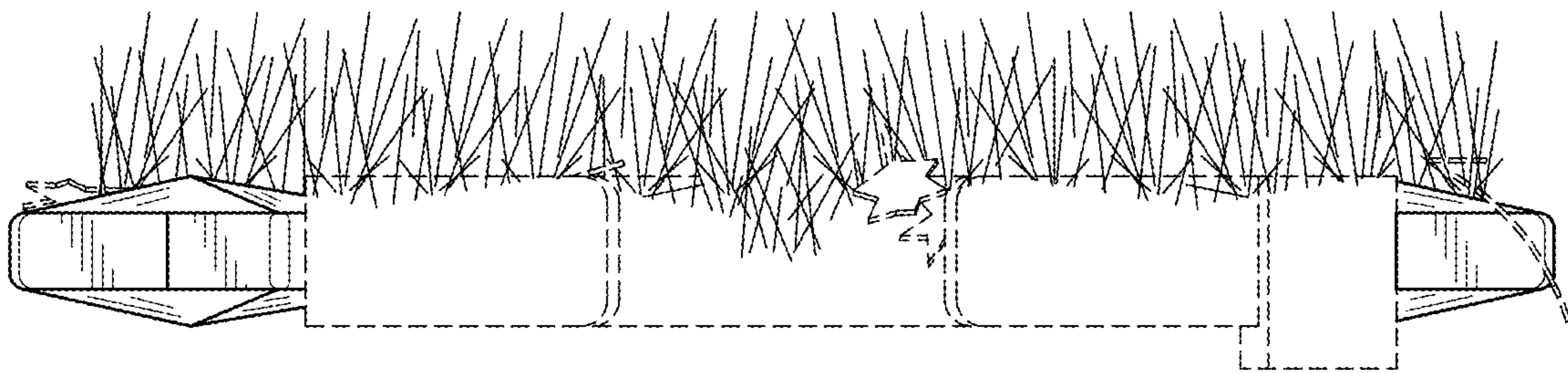

FIG. 5

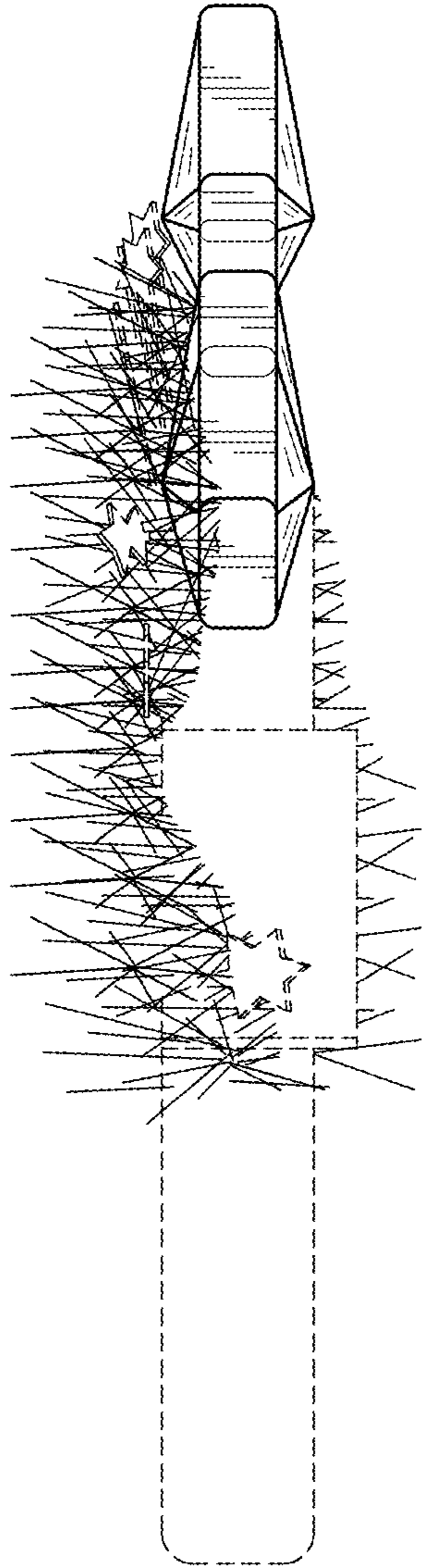

FIG. 6

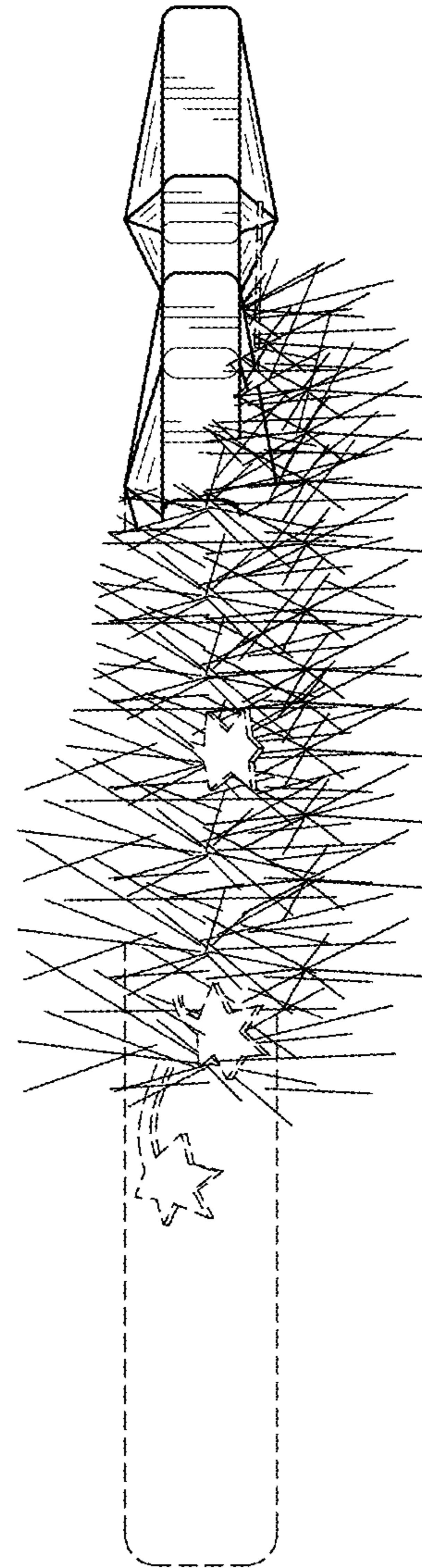

FIG. 7