



US00D954316S

(12) **United States Design Patent** (10) **Patent No.:** **US D954,316 S**
Saboo (45) **Date of Patent:** **** *Jun. 7, 2022**

(54) **FLASHLIGHT WITH AN ELECTRONIC INSECT REPELLENT**

D606,220 S * 12/2009 Kim D26/46
D606,686 S * 12/2009 Kim D26/46
D606,687 S * 12/2009 Kim H01M 50/213
D26/46
D619,284 S * 7/2010 Kim D26/49
(Continued)

(71) Applicant: **West Coast Imports, Inc.**, Commerce, CA (US)

(72) Inventor: **Vinay Saboo**, Commerce, CA (US)

(73) Assignee: **WEST COAST IMPORTS, INC.**, Commerce, CA (US)

(*) Notice: This patent is subject to a terminal disclaimer.

(**) Term: **15 Years**

(21) Appl. No.: **29/806,962**

(22) Filed: **Sep. 8, 2021**

FOREIGN PATENT DOCUMENTS

CN 304152418 * 5/2017
EM 000831268-0001 * 2/2008
EM 002753012-0002 * 2/2015

OTHER PUBLICATIONS

“GLOUE Bug Zapper Light Bulb,” Jun. 10, 2019 (Q&A), amazon.com, site visited Jun. 16, 2021, URL: <https://www.amazon.com/GLOUE-Zapper-Mosquito-Killer-Electronic/dp/B07RPLZYJD/> (Year: 2019).*

(Continued)

Related U.S. Application Data

(60) Continuation-in-part of application No. 29/800,831, filed on Jul. 23, 2021, now Pat. No. Des. 941,512, which is a division of application No. 29/694,652, filed on Jun. 12, 2019, now Pat. No. Des. 929,628.

(51) **LOC (13) Cl.** **26-02**

(52) **U.S. Cl.**
USPC **D26/37; D26/38**

(58) **Field of Classification Search**
USPC D26/37-44, 46-52; D10/111-115
CPC ... F21Y 2115/10; F21Y 2113/13; F21L 4/027;
F21L 4/025; F21L 4/085; F21V 23/0414;
F21V 9/083
See application file for complete search history.

Primary Examiner — Eric L Goodman
Assistant Examiner — Sarah L Smith

(74) *Attorney, Agent, or Firm* — Tarter Krinsky & Drogin LLP

(57) **CLAIM**

The ornamental design for a flashlight with an electronic insect repellent, as shown and described.

DESCRIPTION

FIG. 1 is a perspective view of a flashlight with an electronic insect repellent;
FIG. 2 is a front view thereof;
FIG. 3 is a first side view thereof;
FIG. 4 is a rear view thereof;
FIG. 5 is a second side view thereof;
FIG. 6 is a bottom view thereof; and,
FIG. 7 is a top view thereof.

The broken lines shown in the figures show portions of the flashlight that form no part of the claimed design.

1 Claim, 4 Drawing Sheets

(56) **References Cited**

U.S. PATENT DOCUMENTS

D455,513 S * 4/2002 Galli D26/49
D501,054 S * 1/2005 Galli D26/37
D565,220 S * 3/2008 Galli D26/49
D601,737 S * 10/2009 Swan D26/49

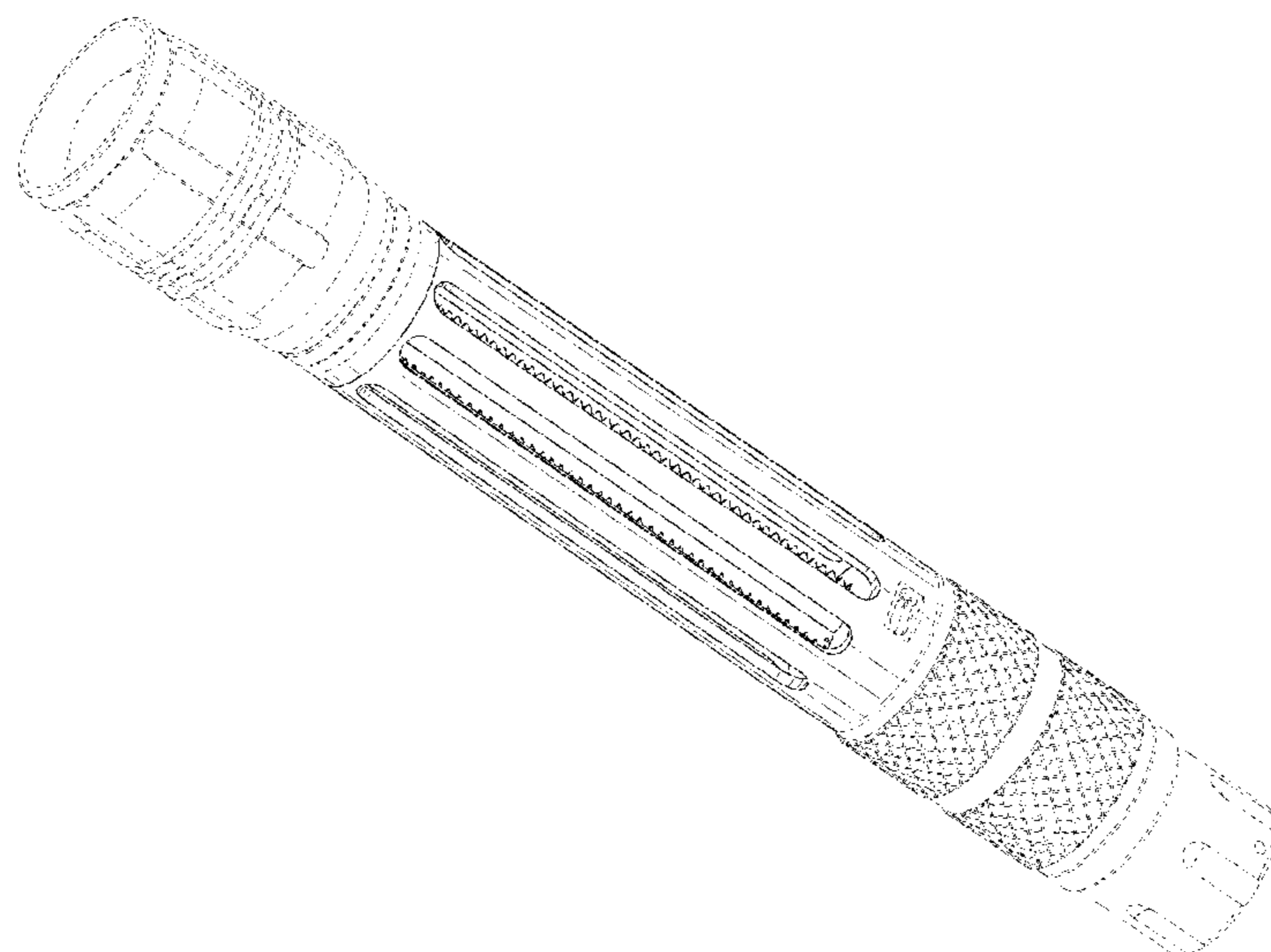

(56)

References Cited

U.S. PATENT DOCUMENTS

7,784,963 B2 * 8/2010 Galli F41G 1/35
 362/184
 8,567,556 B2 * 10/2013 Dueck F41A 21/325
 181/223
 D709,233 S * 7/2014 Inskeep D26/49
 8,973,481 B2 * 3/2015 Dueck F41A 21/325
 89/14.4
 D754,899 S * 4/2016 Cooper F41A 21/325
 D26/49
 D774,230 S * 12/2016 Prieto D26/49
 D780,356 S * 2/2017 Nguyen D26/49
 D804,696 S * 12/2017 Cheng D26/49
 D811,636 S * 2/2018 Galli D26/49
 D832,390 S * 10/2018 Geissele D22/108
 D885,626 S * 5/2020 Inskeep D26/49
 D929,628 S * 8/2021 Saboo D26/38
 11,160,267 B2 * 11/2021 Saboo F21L 4/025

2003/0147239 A1 * 8/2003 Galli F21V 23/0414
 362/205
 2004/0105258 A1 * 6/2004 Galli G02F 1/1339
 362/205
 2012/0033416 A1 * 2/2012 Ballard H01M 50/213
 362/202
 2016/0013675 A1 * 1/2016 Workman H02J 7/35
 320/101
 2017/0067605 A1 * 3/2017 Kuo F21L 4/085
 2020/0390078 A1 * 12/2020 Saboo F21L 4/025

OTHER PUBLICATIONS

“Millennials Outdoors Camping Bug Zapper,” May 27, 2019 (review),
 amazon.com, site visited Jun. 17, 2021, URL: <https://www.amazon.com/Millennials-Outdoors-Electronic-Mosquito-Outdoor/dp/B07QS343L6/> (Year: 2019).*

* cited by examiner

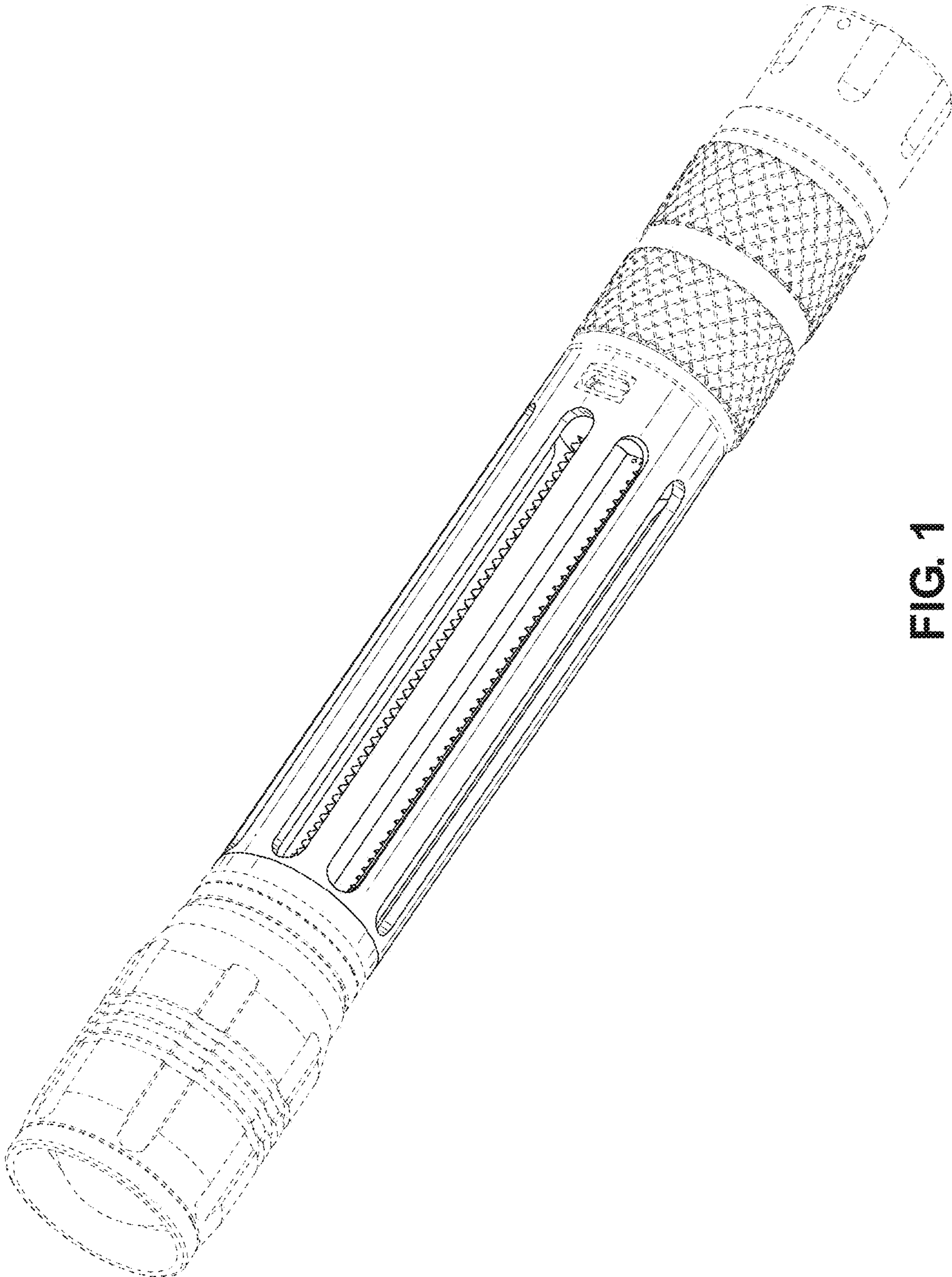

FIG. 1

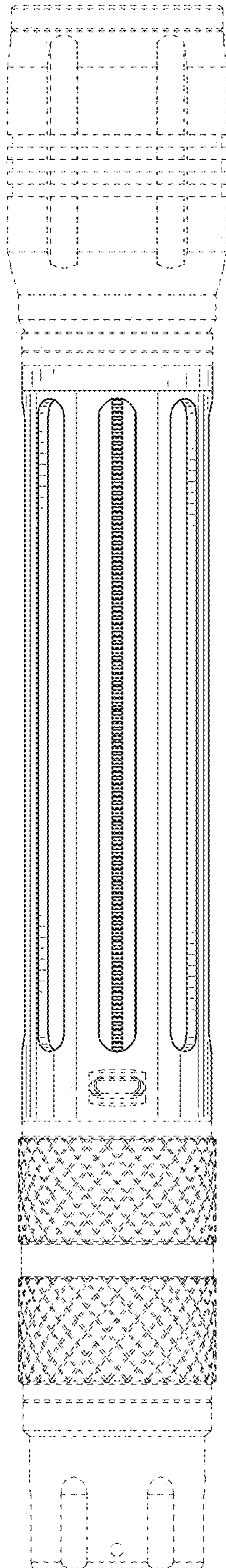

FIG. 2

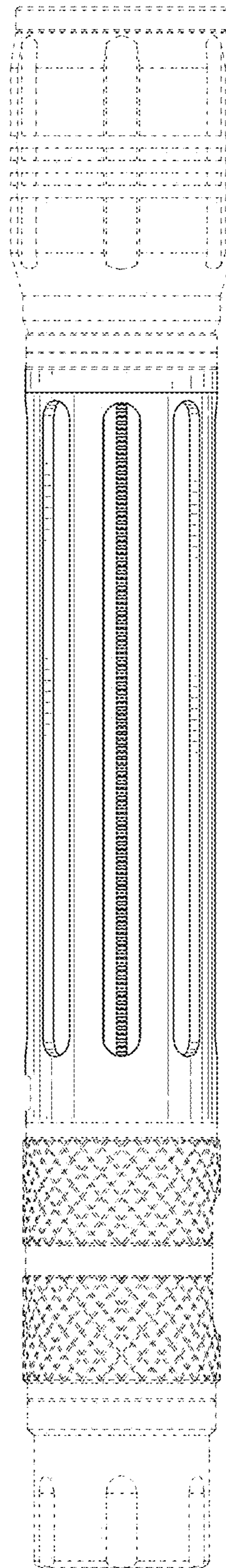

FIG. 3

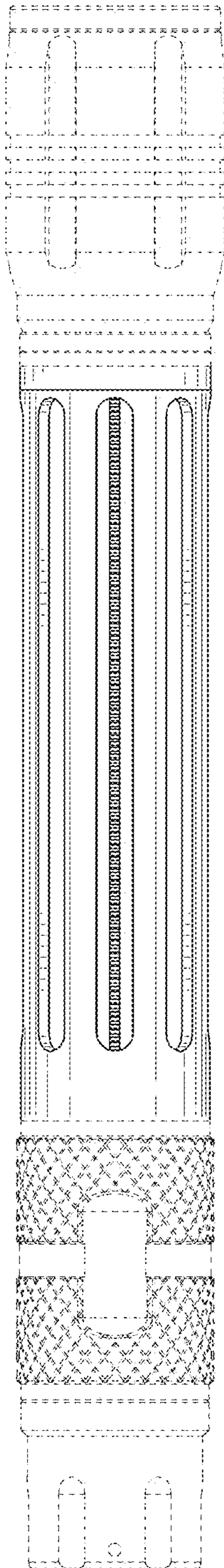

FIG. 4

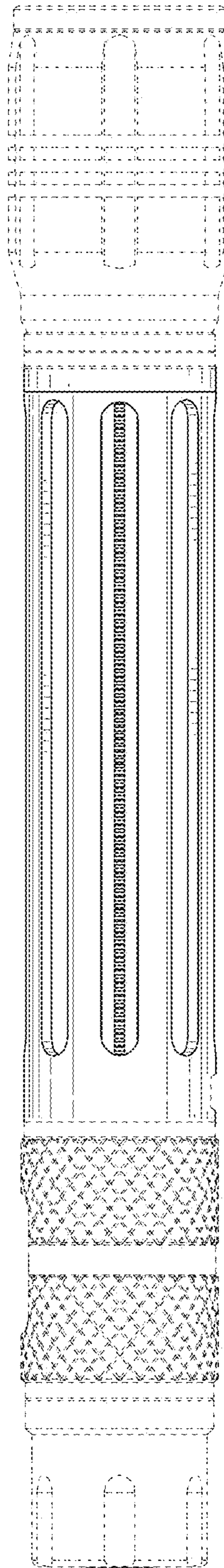

FIG. 5

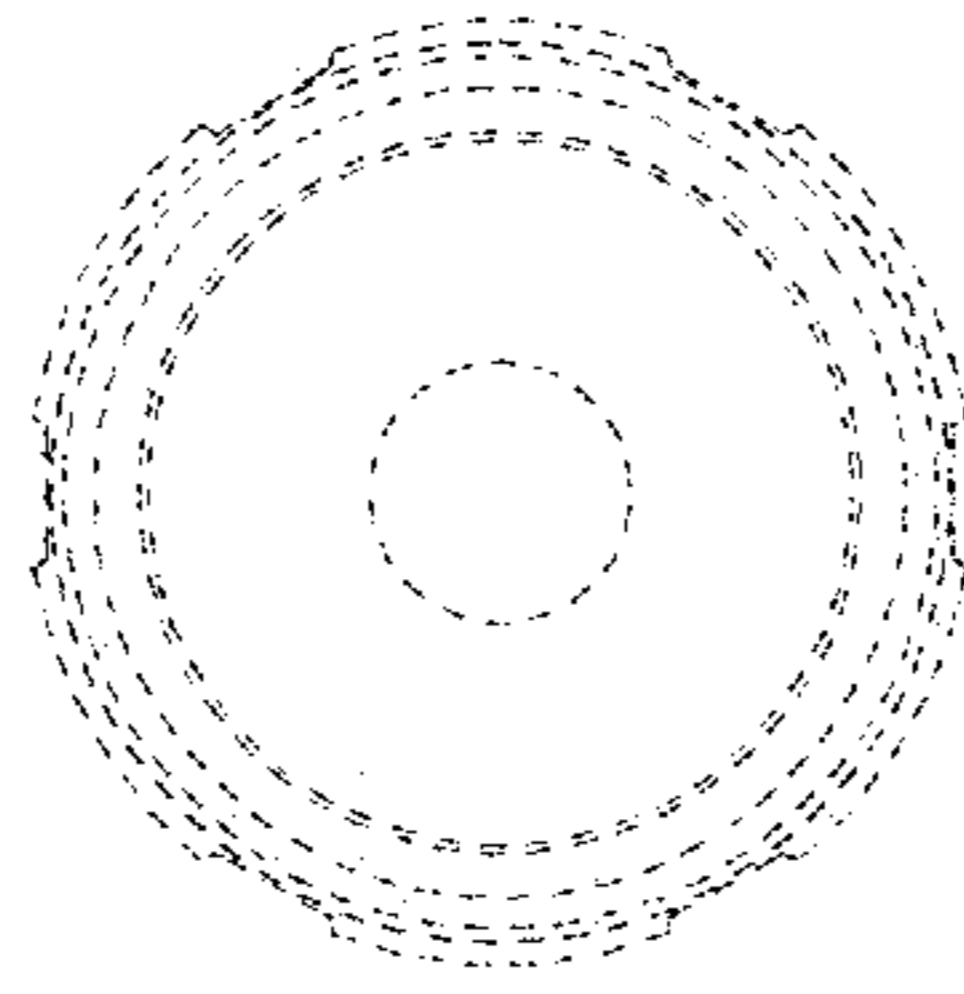

FIG. 7

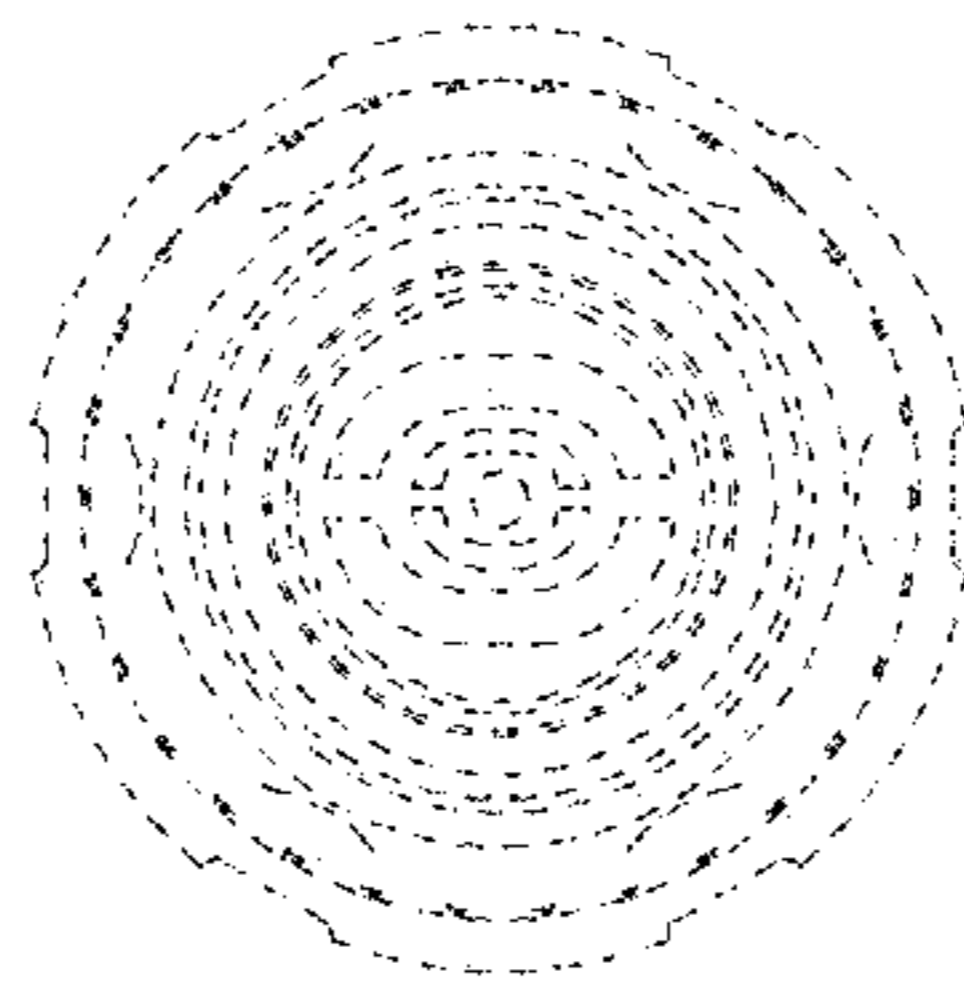

FIG. 6