



US00D954284S

(12) **United States Design Patent**
McGinn

(10) **Patent No.:** **US D954,284 S**

(45) **Date of Patent:** **** *Jun. 7, 2022**

(54) **NECK MASSAGE DEVICE**

(71) Applicant: **Kevin James McGinn**, Danvers, MA
(US)

(72) Inventor: **Kevin James McGinn**, Danvers, MA
(US)

(*) Notice: This patent is subject to a terminal disclaimer.

(**) Term: **15 Years**

(21) Appl. No.: **29/700,641**

(22) Filed: **Aug. 5, 2019**

(51) **LOC (13) Cl.** **28-03**

(52) **U.S. Cl.**
USPC **D24/215**

(58) **Field of Classification Search**
USPC D24/200, 211, 212, 213, 214, 215;
D30/160; D6/601
CPC A61H 19/32; A61H 19/50; A47G 9/10;
A47G 9/1081
See application file for complete search history.

(56) **References Cited**

U.S. PATENT DOCUMENTS

D341,893 S *	11/1993	Tauber	D24/191
6,907,883 B2 *	6/2005	Lin	A61F 5/41
				128/842
D523,958 S *	6/2006	Fang	D24/105
D552,748 S *	10/2007	Gromosaik	D11/26
D552,749 S *	10/2007	Gromosaik	D11/26
D552,750 S *	10/2007	Gromosaik	D11/26
D557,805 S *	12/2007	Gromosaik	D24/105
D557,806 S *	12/2007	Gromosaik	D24/105
D564,666 S *	3/2008	Klearman	D11/26
D581,544 S *	11/2008	Adams	D24/105
D643,129 S *	8/2011	Talbot	D24/215
D674,477 S *	1/2013	Beresford-Wylie	D24/105
D674,910 S *	1/2013	Adams	D24/215
D676,141 S *	2/2013	Wu	D24/215
D684,701 S *	6/2013	Uygur	D24/215
D694,897 S *	12/2013	Small	D24/215

D702,363 S *	4/2014	Tai	D24/215
D704,346 S *	5/2014	Tai	D24/215
D704,347 S *	5/2014	Tai	D24/215
D706,436 S *	6/2014	Hahr	D24/215
D706,437 S *	6/2014	Hahr	D24/215
D706,438 S *	6/2014	Hahr	D24/215

(Continued)

OTHER PUBLICATIONS

Amazon, "Bioswiss_Neck Massager", Sep. 30, 2020. https://www.amazon.com/Bioswiss-Pressure-Point-Neck-Massager/dp/B08HBX78BW/ref=pd_sbs_364_4/139-2069489-8487431?_encoding=UTF8&pd_rd_i=B08HBX78BW&pd_rd_r=bfd8e0a2-ffb5-4e5f-befc-68edc2b7f8ea&pd_rd_w=rcPxC&pd_rd_wg=SbTJa&pf_rd_p=b65ee9. p. 1. (Year: 2020).*

Primary Examiner — Michael A Maharajh

(74) *Attorney, Agent, or Firm* — Legalforce RAPC
Worldwide

(57) **CLAIM**

The ornamental design for a neck massage device, as shown and described.

DESCRIPTION

FIG. 1 is a front-side perspective view of a neck massage device, showing my new design;
FIG. 2 is a back left-side perspective view thereof;
FIG. 3 is a front right-side isometric view thereof;
FIG. 4 is a bottom right-side view thereof;
FIG. 5 is a top left-side view thereof;
FIG. 6 is a front elevational view thereof;
FIG. 7 is a left elevational view thereof;
FIG. 8 is a right elevational view thereof;
FIG. 9 is a top plan elevational view thereof;
FIG. 10 is a bottom plan elevational view thereof;
FIG. 11 is a right-side view thereof;
FIG. 12 is another right-side view thereof; and,
FIG. 13 is another right-side view thereof.
The broken lines on the surface portions indicate the pattern of the neck massage device.

1 Claim, 13 Drawing Sheets

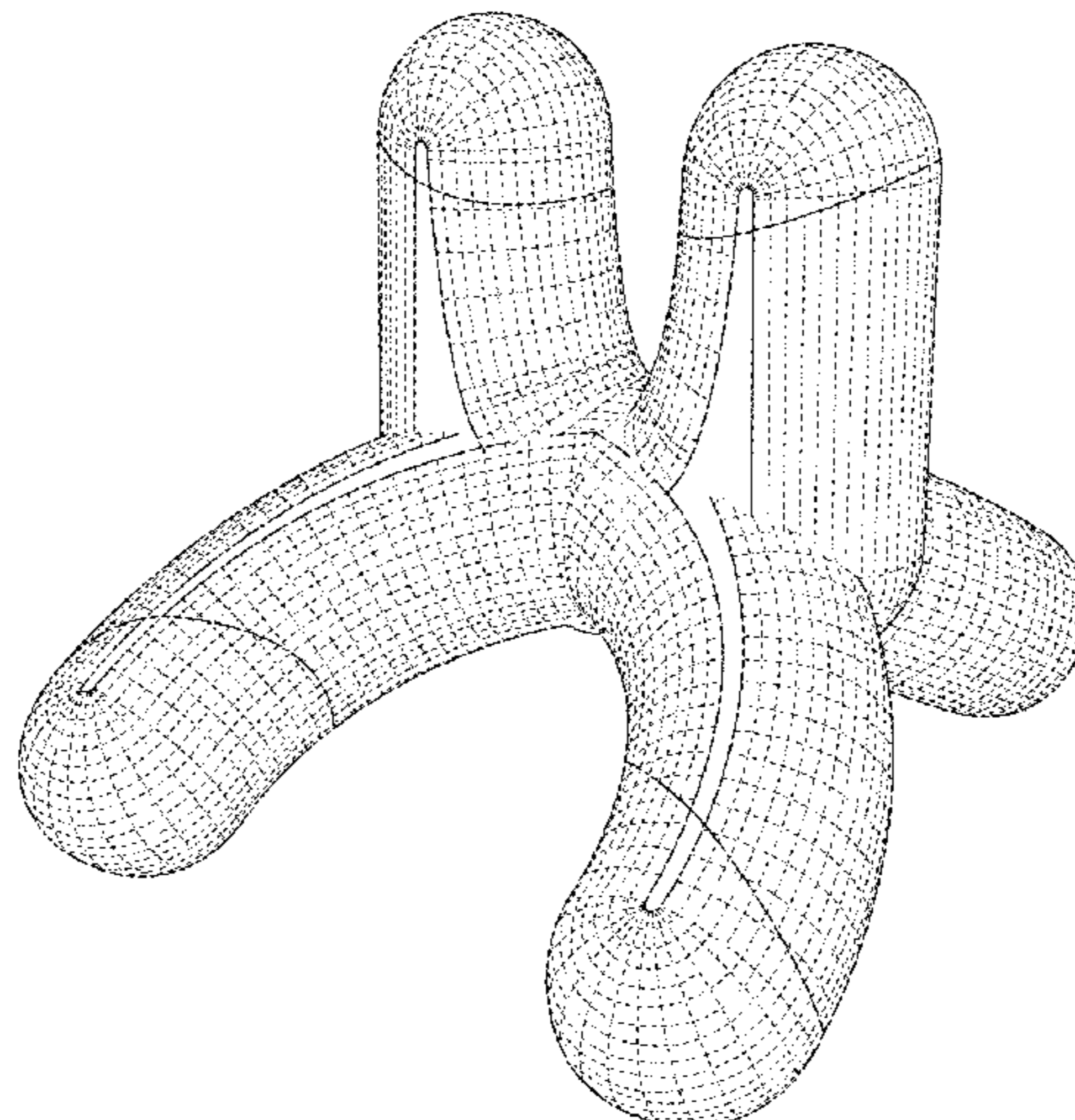

(56)

References Cited

U.S. PATENT DOCUMENTS

D706,439 S *	6/2014	Hahr	D24/215	2005/0283044 A1 *	12/2005	Chang	A61F 5/41 600/38
D706,443 S *	6/2014	Hahr	D24/215	2007/0118199 A1 *	5/2007	Yang	A61H 19/00 607/143
D707,840 S *	6/2014	Levine	D24/215	2009/0012355 A1 *	1/2009	Lin	A61H 19/50 600/41
D707,841 S *	6/2014	Levine	D24/215	2009/0069629 A1 *	3/2009	Uson Calvo	A61H 19/34 600/38
D725,283 S *	3/2015	Sedic	D24/215	2009/0306468 A1 *	12/2009	Tasker	A61H 19/50 600/41
D727,526 S *	4/2015	Mercado Diaz	D24/215	2009/0318755 A1 *	12/2009	Adams	A61F 5/41 600/41
D742,535 S *	11/2015	Wu	D24/215	2012/0259254 A1 *	10/2012	Chen	A61H 19/40 601/46
D752,298 S *	3/2016	Stephens	D30/199	2015/0157531 A1 *	6/2015	Sedic	A61H 19/32 601/46
D769,453 S *	10/2016	Ma	D24/215	2015/0313749 A1 *	11/2015	Hahr	A61H 19/50 600/39
D771,270 S *	11/2016	Tai	D24/215	2016/0106569 A1 *	4/2016	Hahr	A61F 5/41 600/41
D771,831 S *	11/2016	Barnard	D24/215	2017/0042757 A1 *	2/2017	Wang	A61H 19/34
D773,066 S *	11/2016	Sedic	D24/215	2018/0193221 A1 *	7/2018	Li	A61H 19/32
D793,571 S *	8/2017	Iurchenko	D24/215	2018/0193620 A1 *	7/2018	Barasch	A61H 19/32
D808,034 S *	1/2018	Matsuura	D24/215	2020/0069511 A1 *	3/2020	Lopez	G06F 3/0346
D824,037 S *	7/2018	Yueh	D24/215	2020/0093685 A1 *	3/2020	Luke	A61H 1/00
D853,577 S *	7/2019	Li	D24/215				
D858,143 S *	9/2019	Tu	A47C 7/383 D6/601				
D917,929 S *	5/2021	Yang	D6/601				
D932,803 S *	10/2021	Yang	D6/601				
D933,397 S *	10/2021	Karlsen	D6/601				
2002/0103415 A1 *	8/2002	Manska	A61H 19/32 600/38				

* cited by examiner

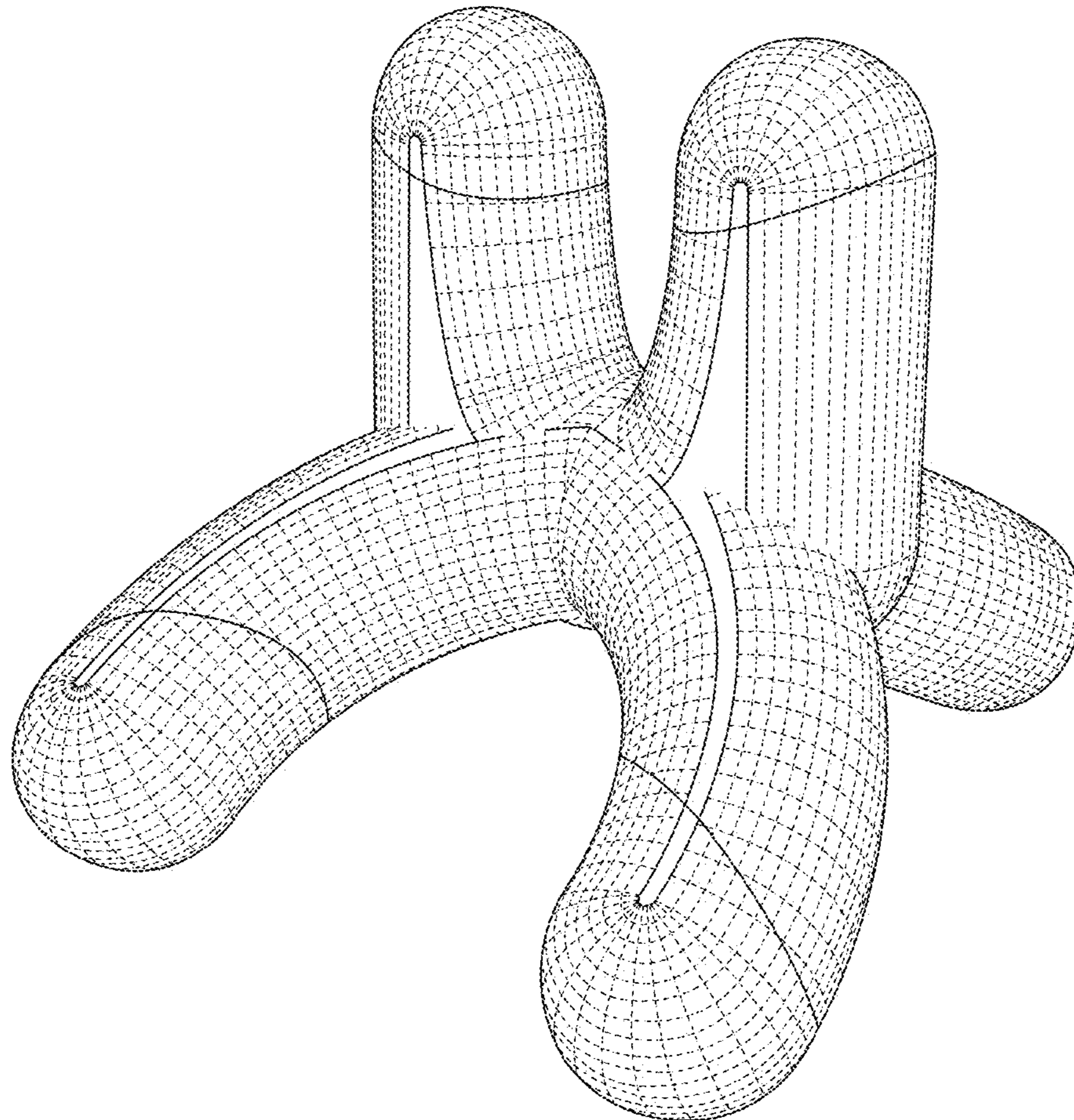

FIG. 1

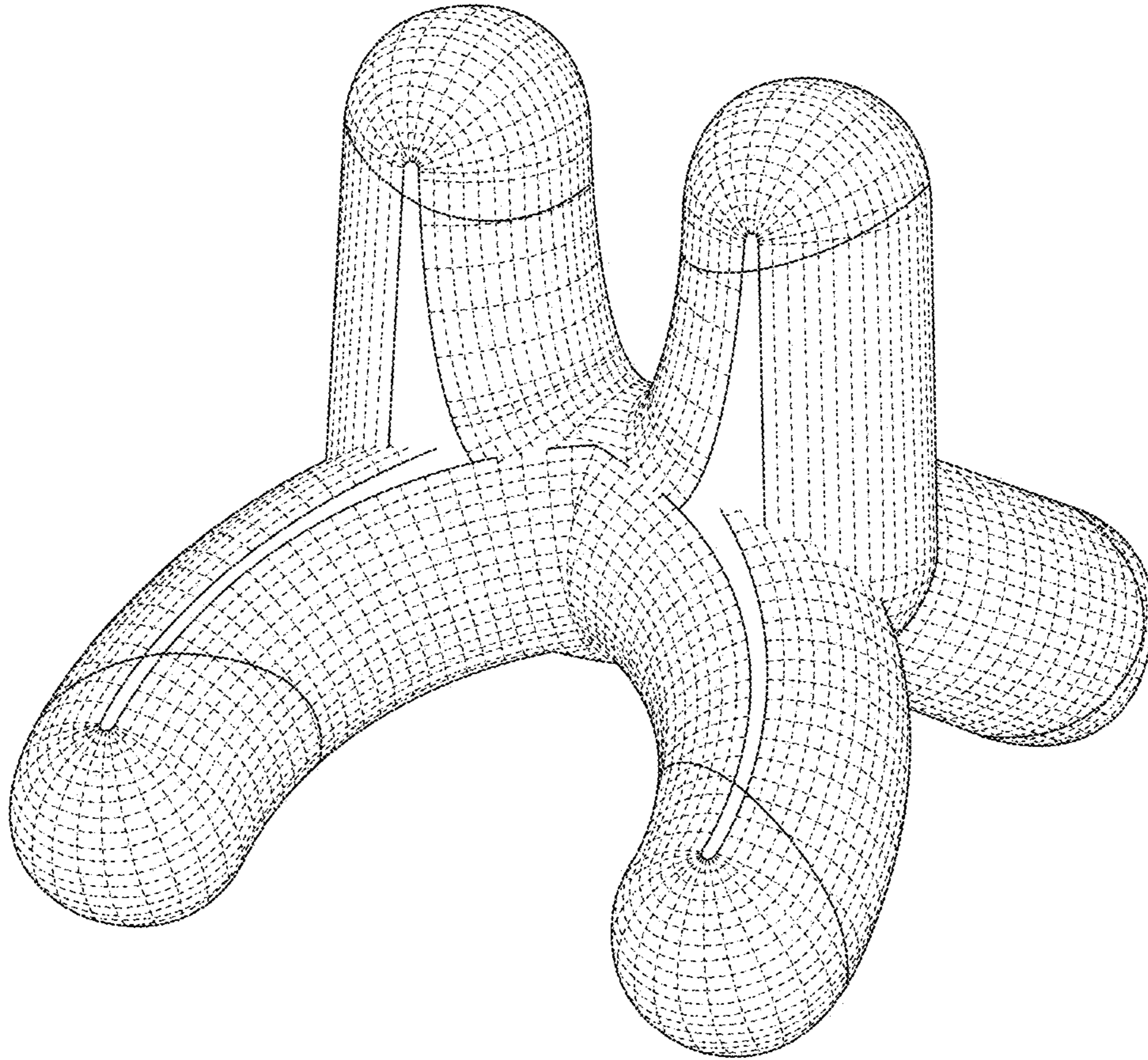

FIG. 2

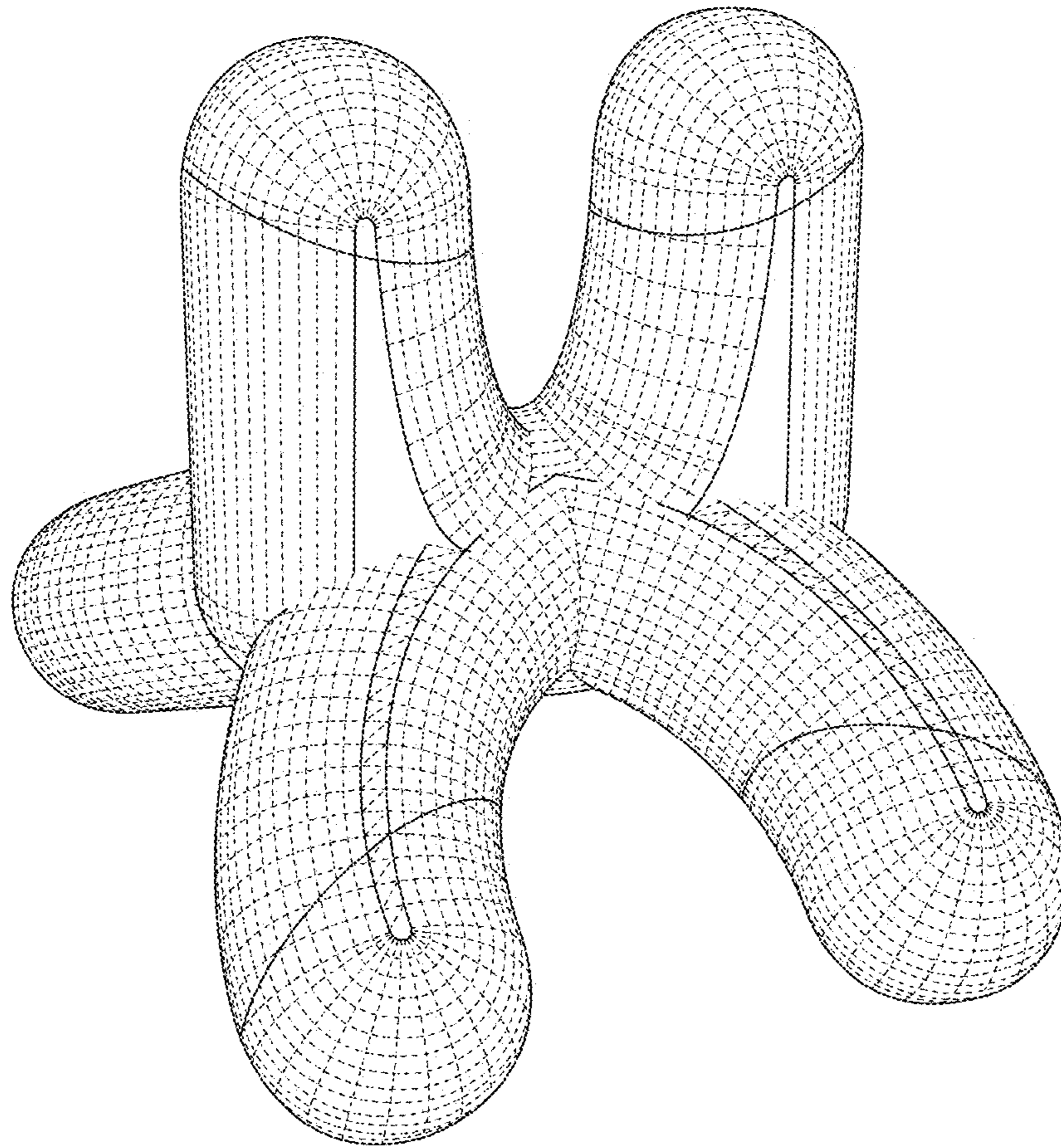

FIG. 3

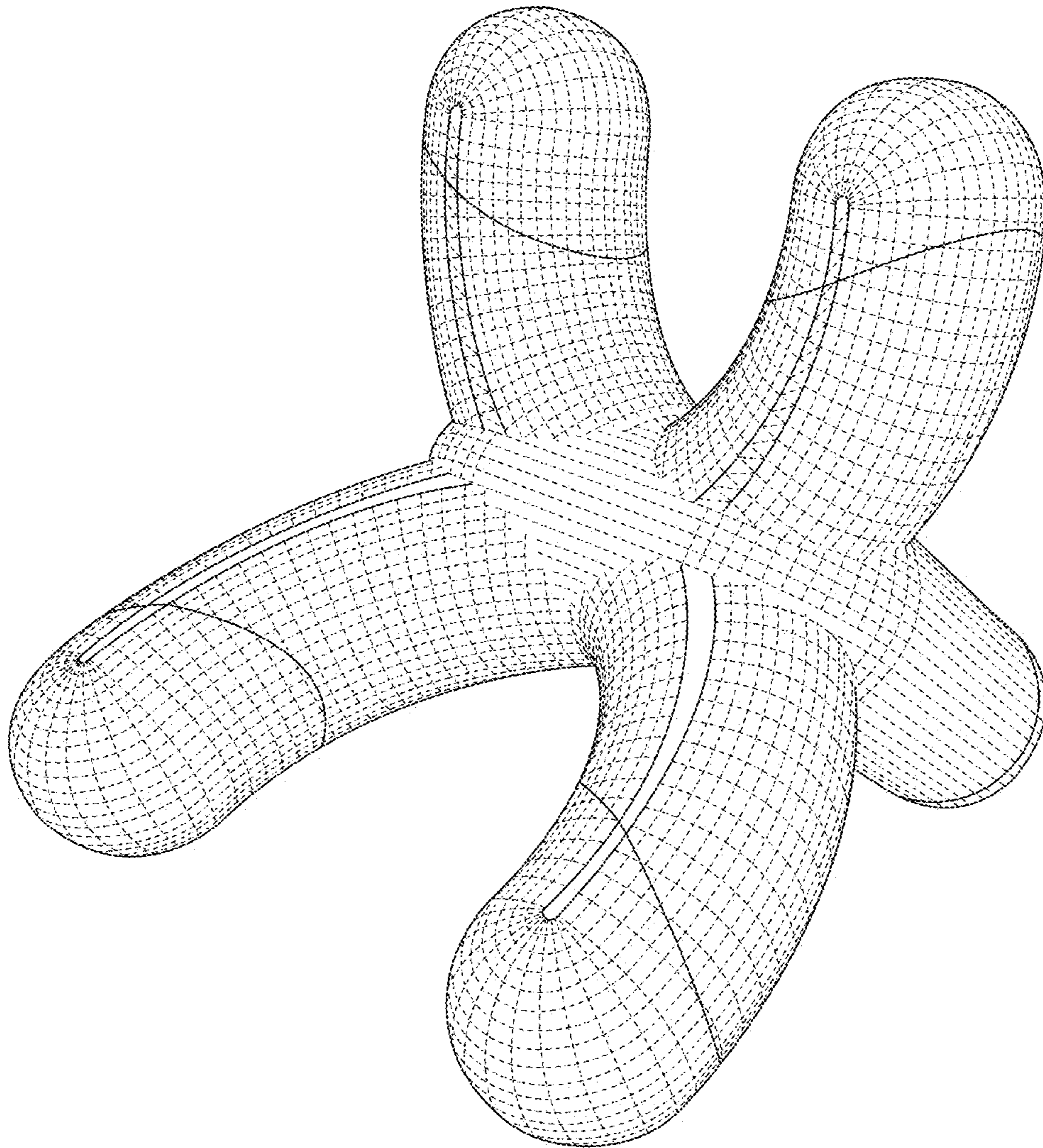

FIG. 4

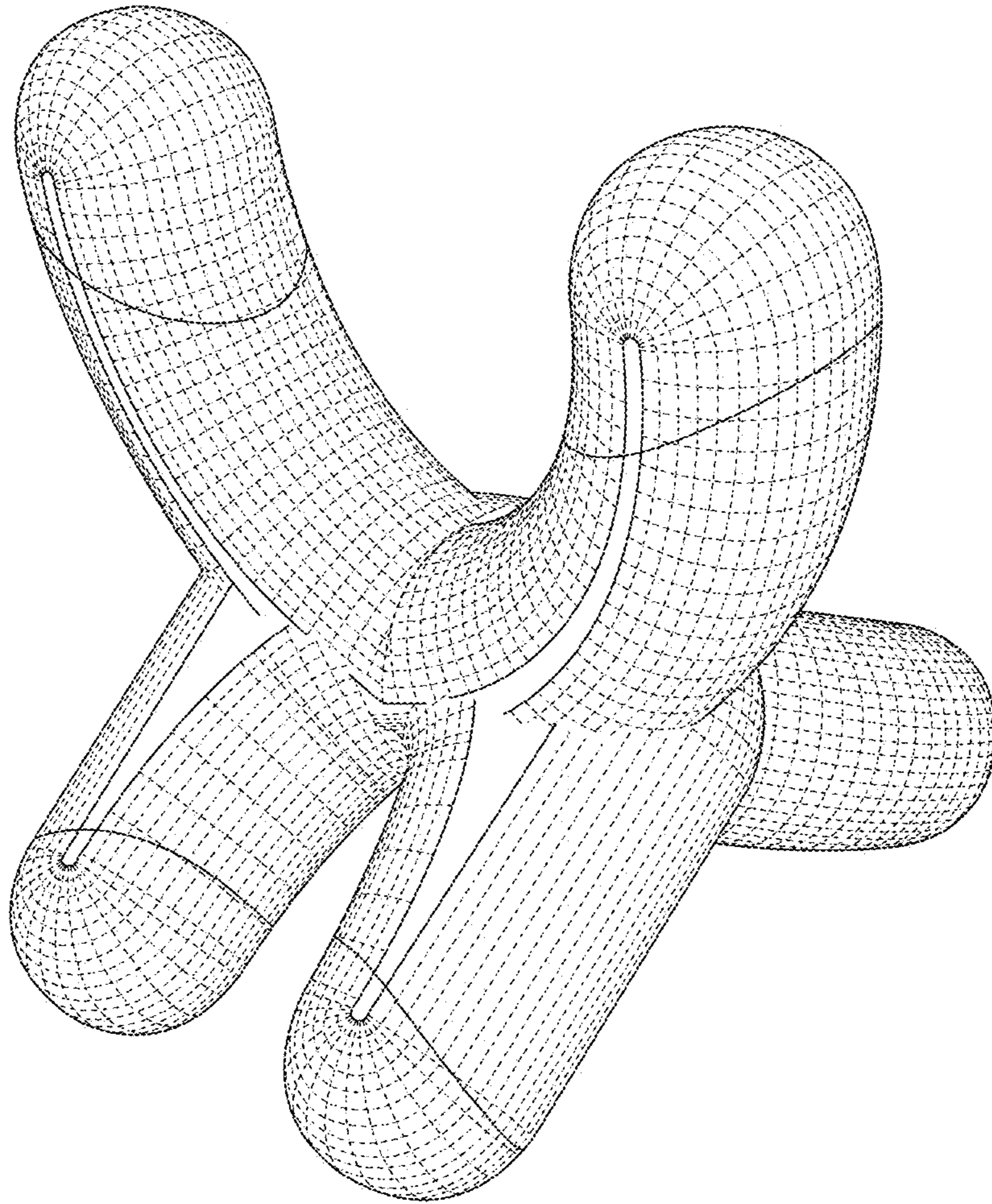

FIG. 5

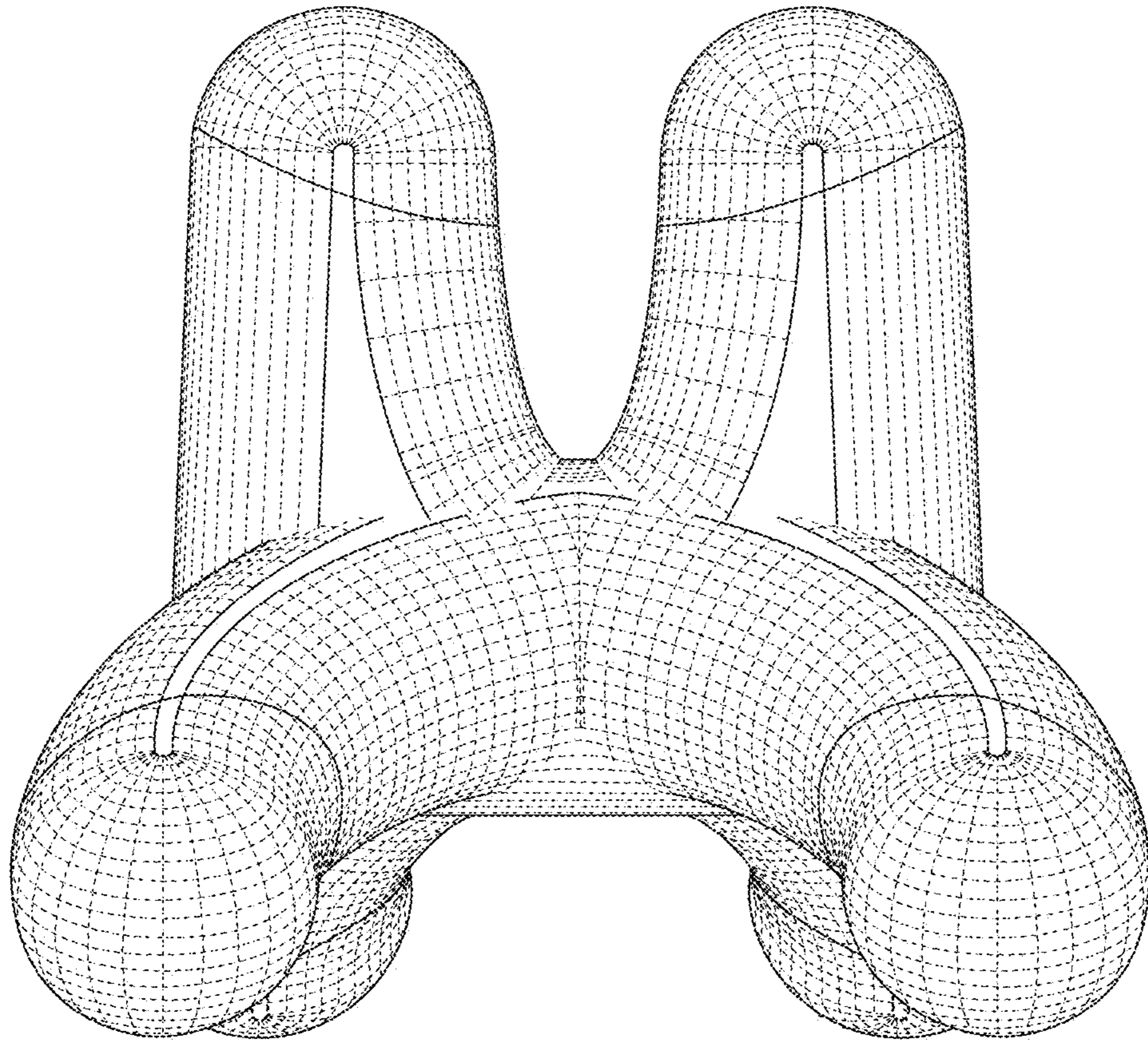

FIG. 6

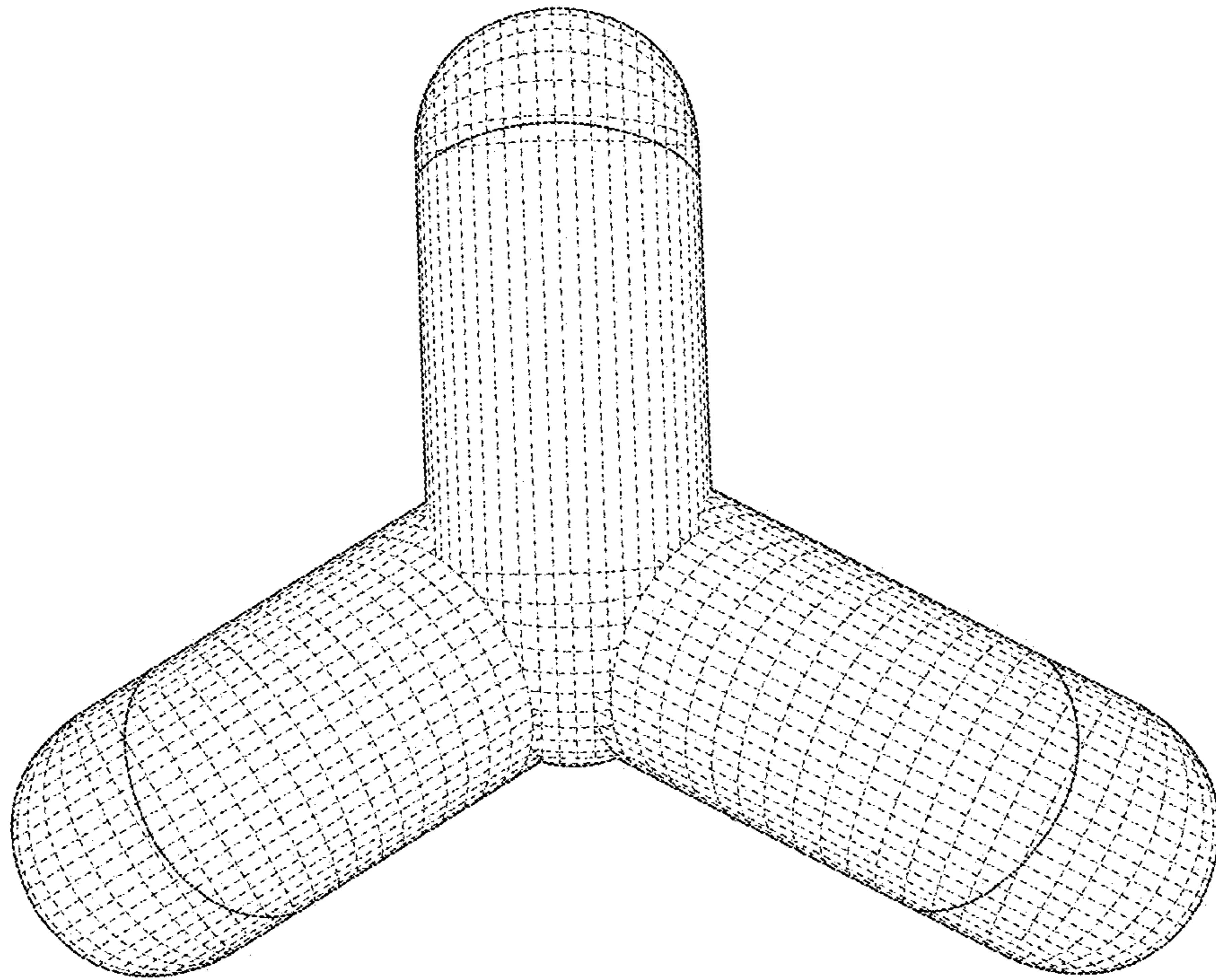

FIG. 7

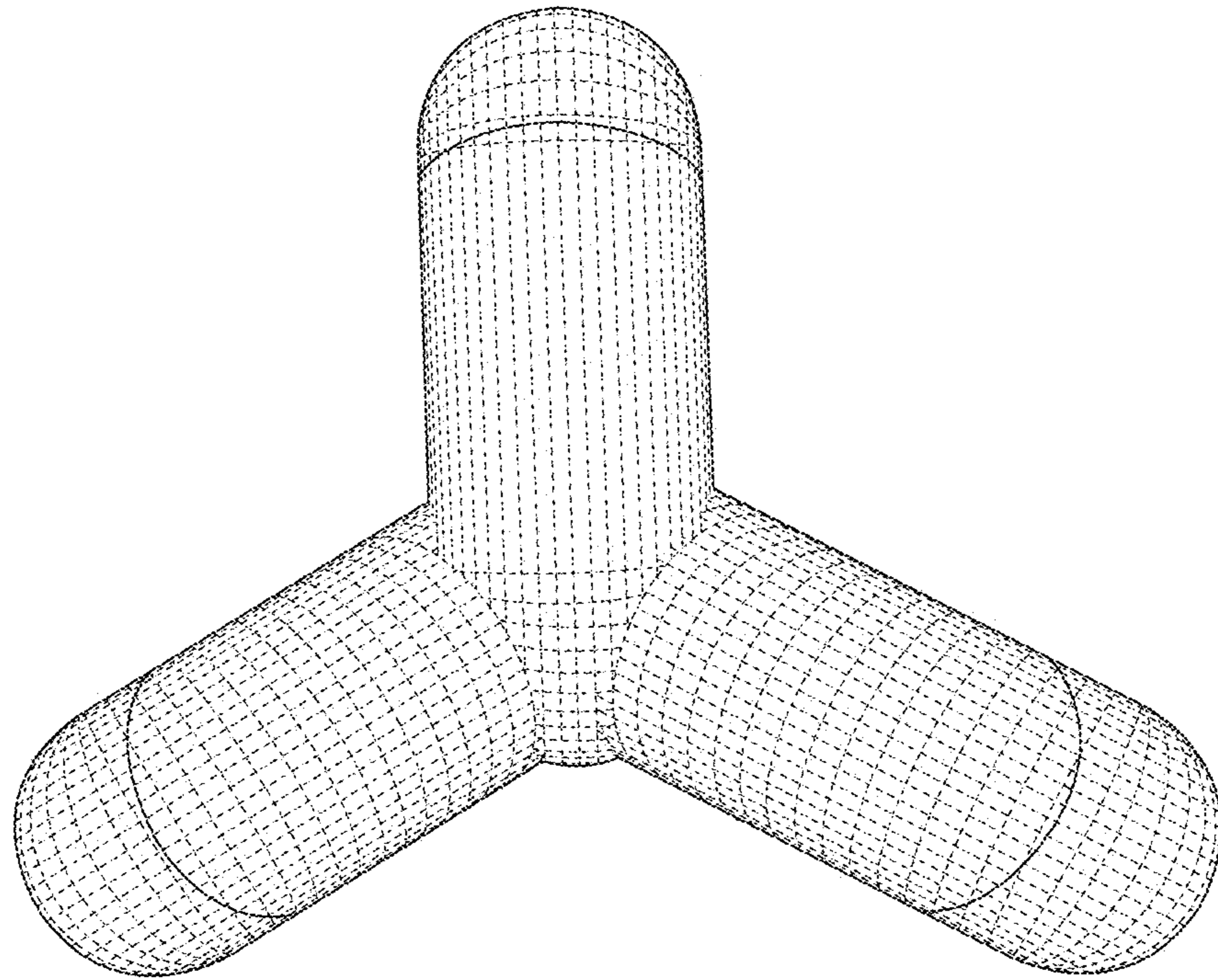

FIG. 8

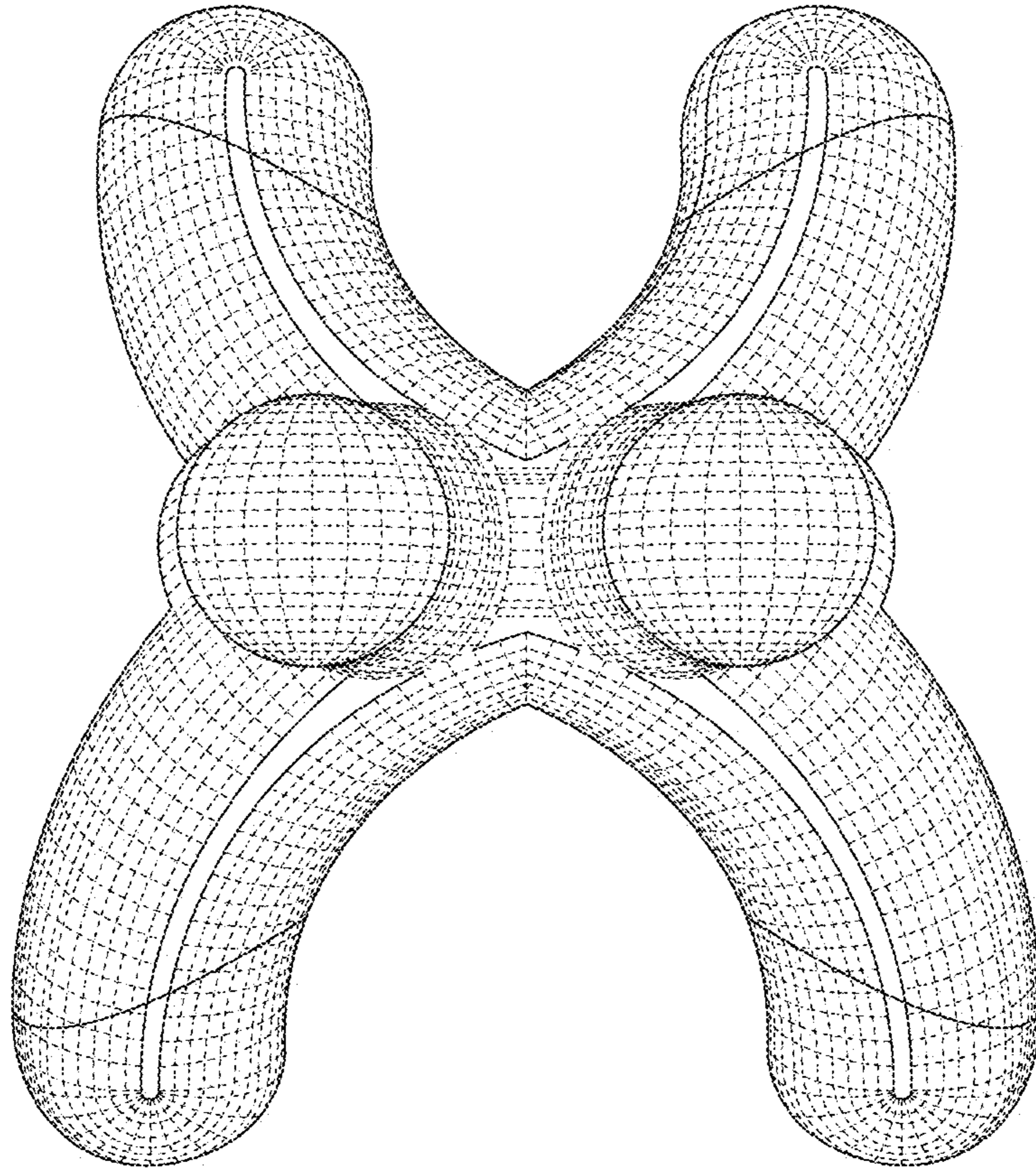

FIG. 9

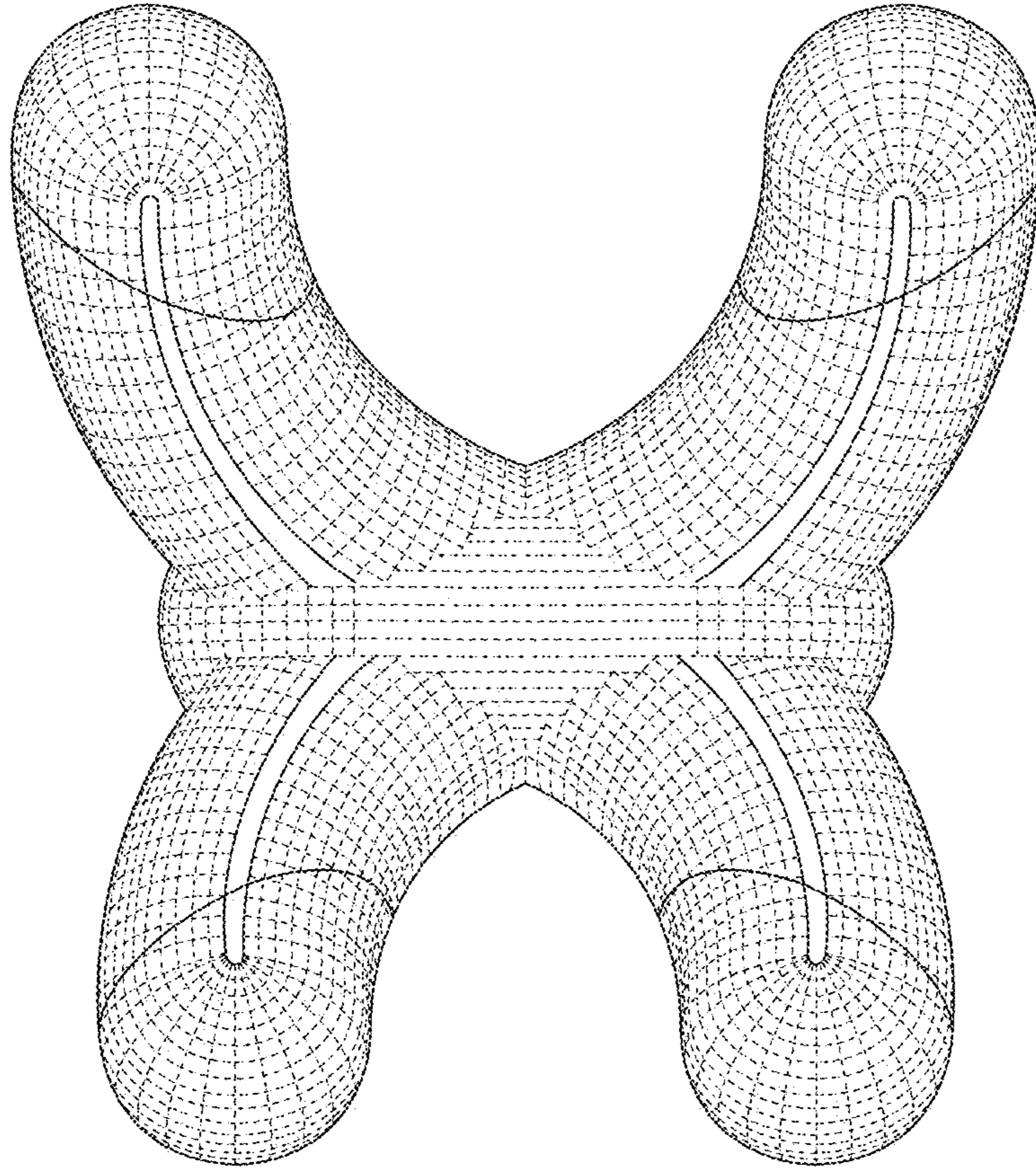

FIG. 10

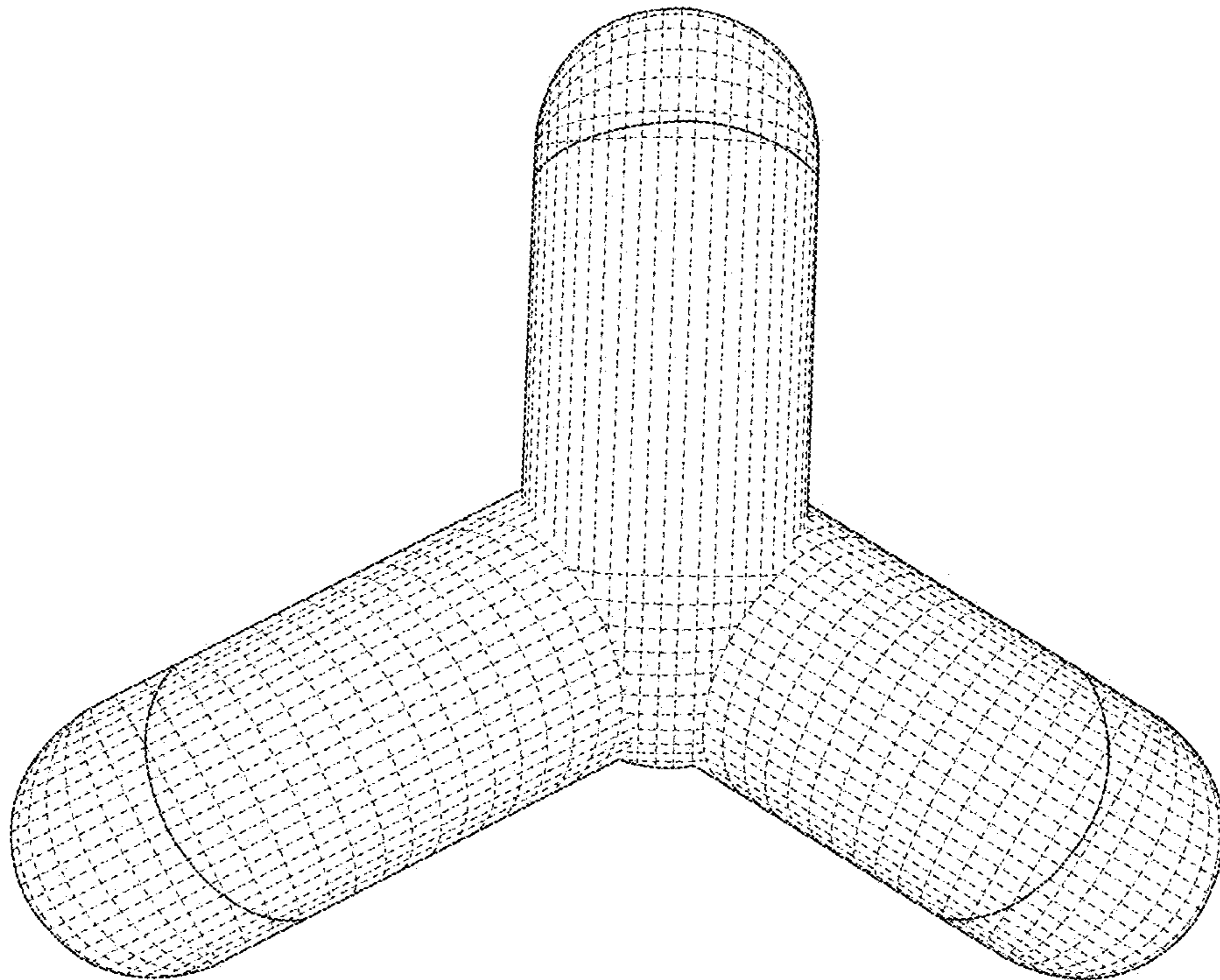

FIG. 11

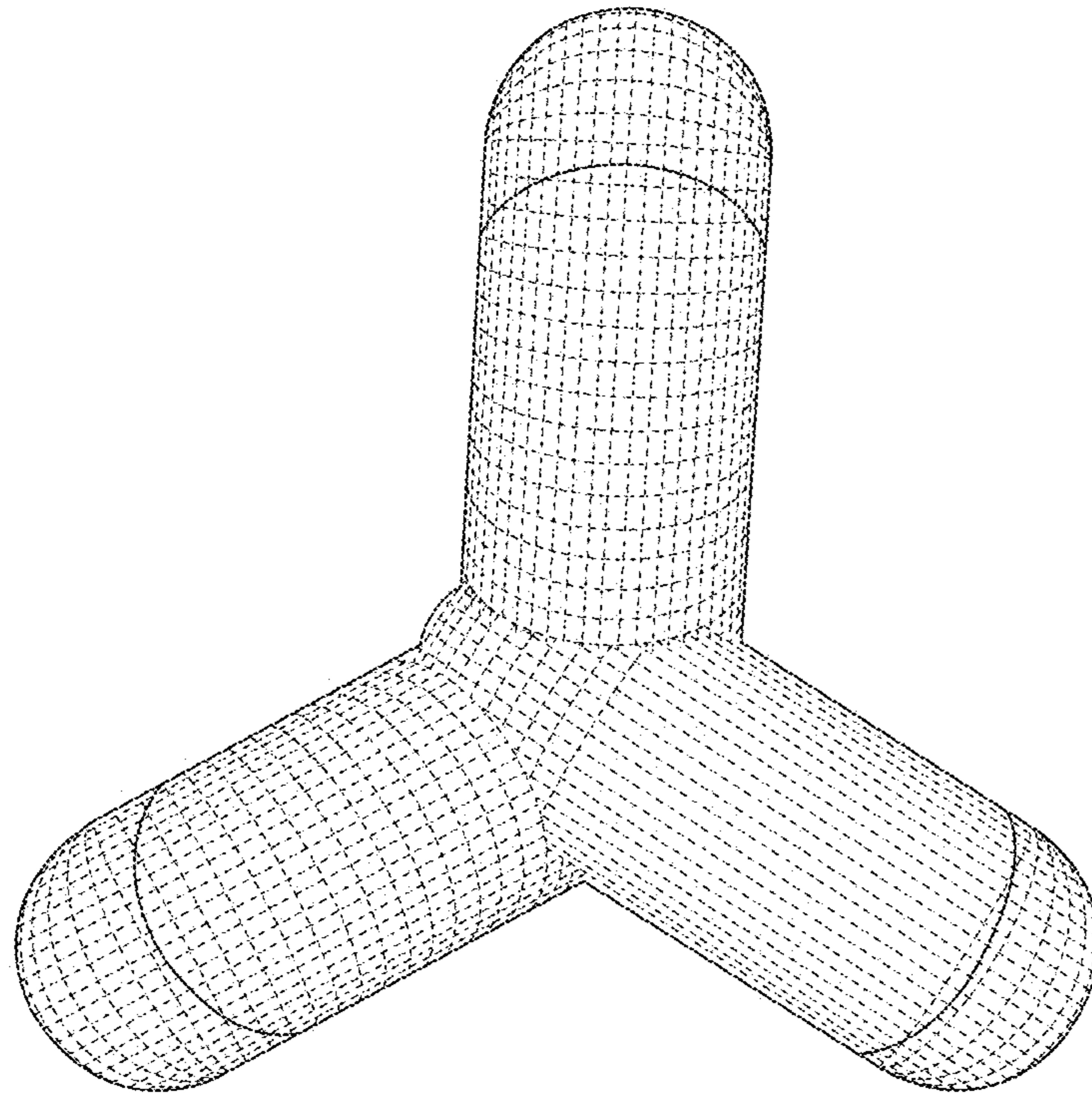

FIG. 12

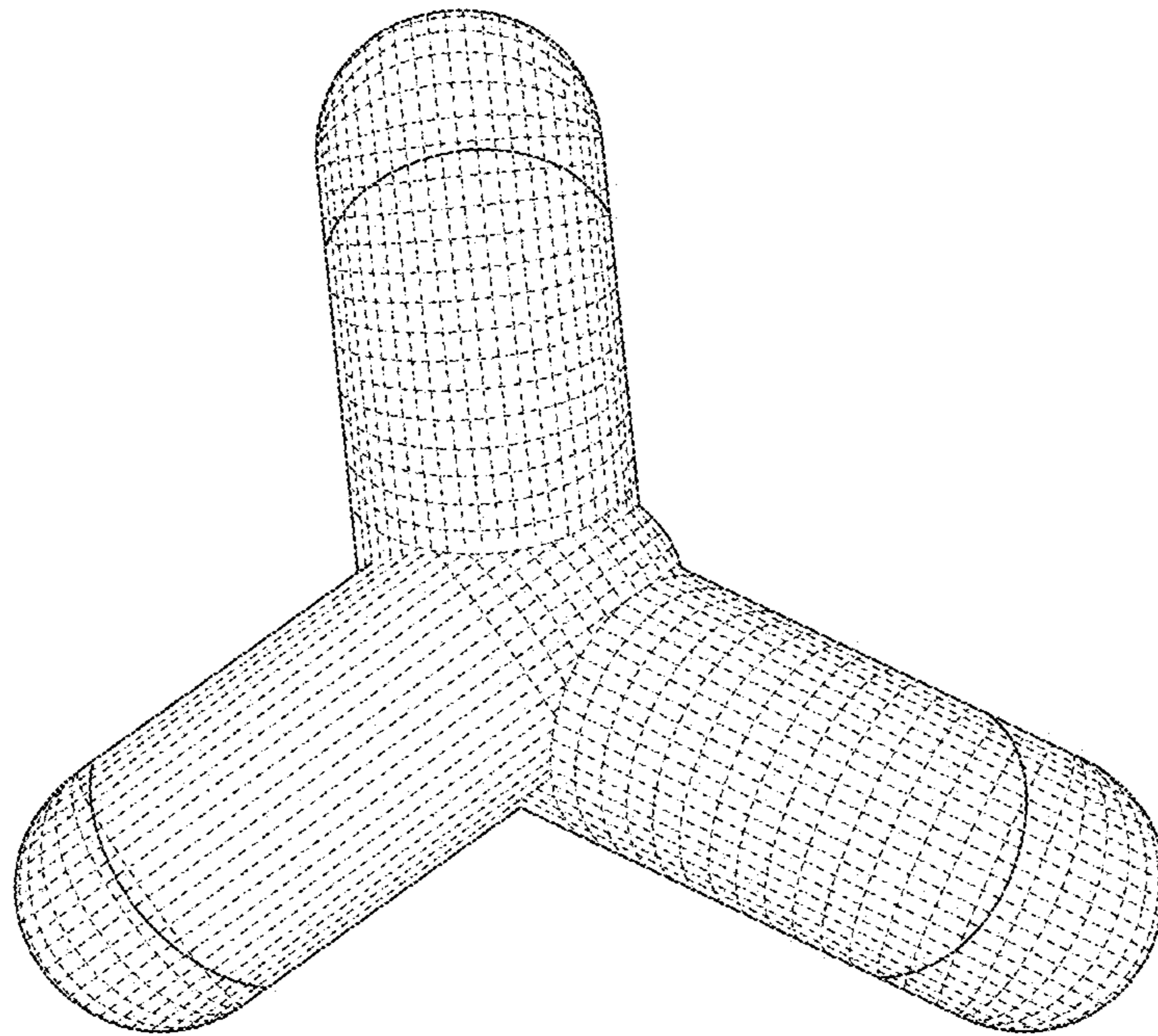

FIG. 13