



US00D954234S

(12) **United States Design Patent** (10) **Patent No.:** **US D954,234 S**
Bucher (45) **Date of Patent:** **** *Jun. 7, 2022**

- (54) **SINK**
- (71) Applicant: **AS America, Inc.**, Piscataway, NJ (US)
- (72) Inventor: **Christophe Bucher**, Hillsborough, NJ (US)
- (73) Assignee: **AS America, Inc.**, Piscataway, NJ (US)
- (*) Notice: This patent is subject to a terminal disclaimer.
- (**) Term: **15 Years**
- (21) Appl. No.: **29/703,789**
- (22) Filed: **Aug. 29, 2019**

D508,555 S 8/2005 Ziemann
 D518,561 S 4/2006 Gordon
 D523,540 S 6/2006 Gordon
 (Continued)

FOREIGN PATENT DOCUMENTS

CA 2639213 C 2/2014
 CA 2882716 A1 8/2015
 (Continued)

OTHER PUBLICATIONS

Amazon, RAK Stella Kitchen Sink, posted Mar. 10, 2018, [online], [visited Jun. 24, 2021]. Internet, <URL: <https://www.amazon.co.uk/RAK-Stella-Belfast-Kitchen-755x455/dp/B07BC8PD5N/ref>> (Year: 2018).*

(Continued)

Primary Examiner — Samantha Wood
 (74) *Attorney, Agent, or Firm* — Morrison & Foerster LLP

Related U.S. Application Data

- (63) Continuation of application No. 29/642,676, filed on Mar. 30, 2018, now Pat. No. Des. 858,722.
- (51) **LOC (13) Cl.** **23-02**
- (52) **U.S. Cl.**
USPC **D23/293.1**
- (58) **Field of Classification Search**
USPC ... D23/270, 284, 286, 293.1, 303, 308, 285, D23/289, 499, 290, 287; D6/524, 641, D6/642
CPC ... E03C 1/12; E03C 1/18; E03C 1/181; E03C 1/182; E03C 1/184; E03C 1/186; A47K 1/04; A47K 1/00; A47K 1/05; A47K 1/10; A47K 1/12; A47B 77/06; A47J 47/20
See application file for complete search history.

(57) **CLAIM**

I claim the ornamental design for a sink, as shown and described.

DESCRIPTION

FIG. 1 is a front perspective view of a sink showing my new design;
 FIG. 2 is a front view thereof;
 FIG. 3 is a rear view thereof;
 FIG. 4 is a side view thereof;
 FIG. 5 is a side view of the opposite side of FIG. 4;
 FIG. 6 is a top view thereof; and,
 FIG. 7 is a bottom view thereof.
 The sink is shown with symbolic breaks in its length. The appearance of any portion of the article between the break lines forms no part of the claimed design.
 The broken lines shown in the drawings illustrate portions of a sink that form no part of the claimed design.

(56) **References Cited**
 U.S. PATENT DOCUMENTS

- 6,182,305 B1 2/2001 O'Connell et al.
- D482,764 S * 11/2003 Genslak D23/293.1
- D498,291 S 11/2004 Bayer
- D501,541 S * 2/2005 Gordon D23/284
- D504,496 S 4/2005 Bayer
- D505,188 S 5/2005 Bayer

1 Claim, 7 Drawing Sheets

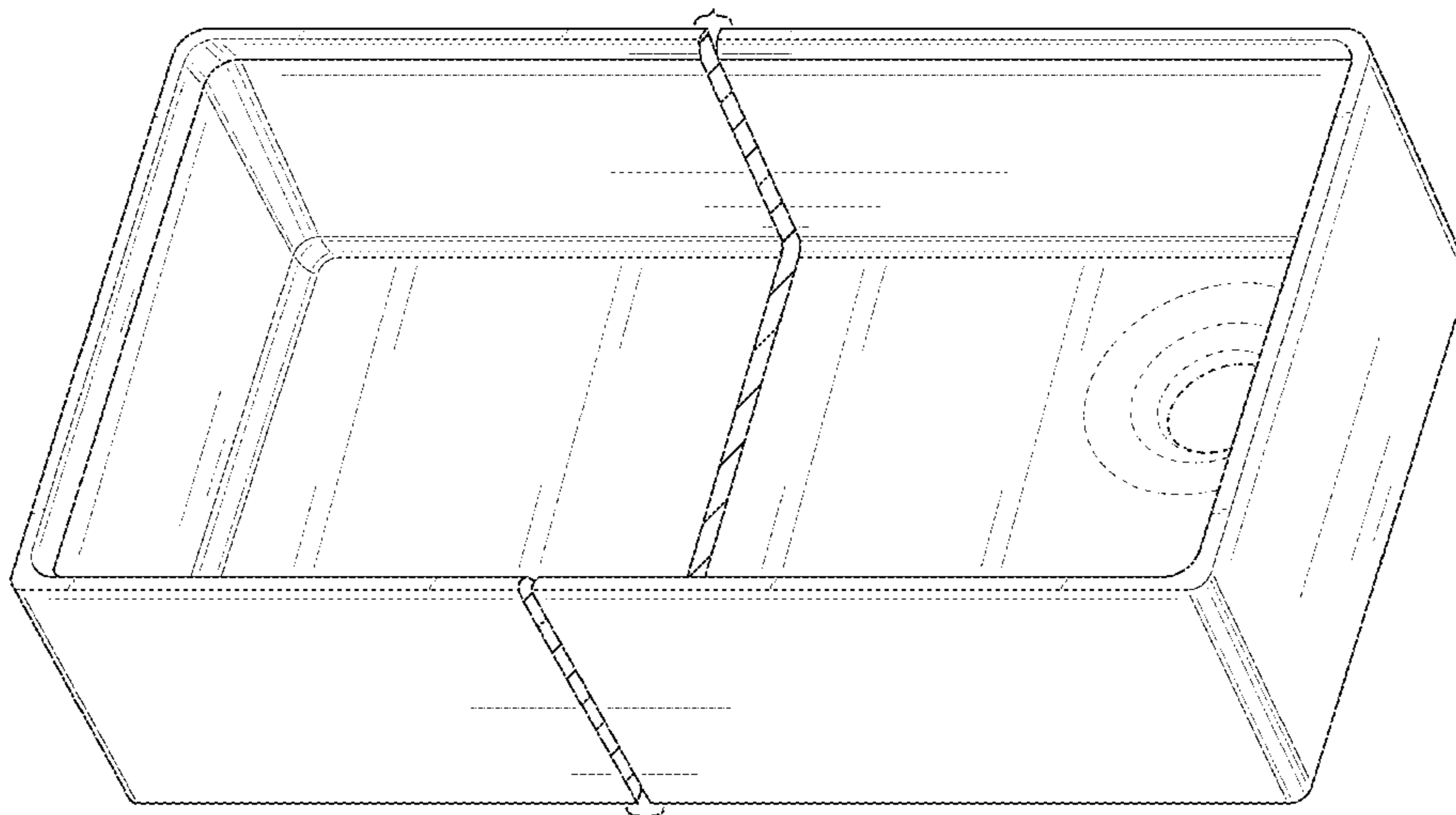

(56)

References Cited

U.S. PATENT DOCUMENTS

D541,912 S 5/2007 Ziemann
 D547,833 S 7/2007 Mahon
 D548,311 S 8/2007 Mahon
 D585,126 S 1/2009 Eilmus et al.
 D586,445 S 2/2009 Ziemann et al.
 D587,351 S 2/2009 Eilmus et al.
 D588,246 S 3/2009 Eilmus et al.
 D601,675 S 10/2009 Booth et al.
 D603,484 S 11/2009 Eilmus
 D607,979 S * 1/2010 Jiang D23/293.1
 D610,659 S * 2/2010 Booth D23/290
 D622,826 S 8/2010 Helmer
 D627,449 S 11/2010 Eckhaus
 D656,228 S 3/2012 Booth
 D669,560 S 10/2012 Booth
 D670,364 S 11/2012 Miller et al.
 D677,772 S 3/2013 Mendoza et al.
 D682,998 S * 5/2013 Eilmus D23/284
 D703,799 S 4/2014 Eilmus et al.
 D707,802 S 6/2014 Jepson
 D767,738 S 9/2016 Osterroth et al.
 RE46,298 E 2/2017 Eilmus et al.
 9,574,333 B2 2/2017 O'Brien et al.
 D782,018 S 3/2017 Eilmus et al.
 9,775,470 B2 10/2017 Eilmus et al.
 9,783,967 B2 10/2017 Jain et al.
 D804,620 S 12/2017 Palazzolo et al.
 D814,615 S * 4/2018 Ziemann D23/293.1
 D816,197 S 4/2018 Chong et al.
 D826,385 S * 8/2018 Ziemann D23/293.1
 D826,386 S * 8/2018 Bomatter D23/293.1
 D849,895 S 5/2019 Bucher
 2006/0242761 A1 11/2006 Babick et al.
 2012/0266377 A1 10/2012 Eilmus

FOREIGN PATENT DOCUMENTS

CN 301999934 7/2012
 CN 303455909 11/2015
 DE 102015107145 A1 11/2016

EP 0900543 A1 3/1999
 EP 1776898 B1 11/2010
 EP 1856339 B1 12/2012
 GB 6004421 * 12/2016

OTHER PUBLICATIONS

Amazon, Old London Farmhouse style sink, posted Aug. 7, 2016, [online], [visited Jun. 28, 2021]. Internet, <URL: <https://www.amazon.co.uk/Old-London-PP1256-Fireclay-Butler/dp/B01JTD4EAU/ref>> (Year: 2016).*

Bucher, U.S. Office Action dated Dec. 12, 2018, directed to U.S. Appl. No. 29/642,676; 5 pages.

First Rectification Notification dated Dec. 18, 2018, directed to CN Application No. 201830544103.3; 2 pages.

Home Depot. (2014) "Whitehaus Collection, Duet Reversible Farmhaus Apron Front Fireclay 30 in. Single Bowl Kitchen Sink in White," located at https://www.homedepot.com/p/Whitehaus-Collection-Duet-Reversible-Farmhaus-Apron-Front-Fireclay-30-in-Single-Bowl-Kitchen-Sink-in-White-WH3018-WH/203865941?MERCH=REC_-PIPHorizontal2_rr_-203866193_-203865941_-N (1 page).

Notification to Grant Patent Right dated Mar. 25, 2019, directed to CN Application No. 201830544103.3; 6 pages.

Shalees Diner Decor (Dec. 11, 2015) "Single Basin Kitchen Sink Photo," located at <https://shaleesdiner.com/the-advantages-of-single-basin-kitchen-sink/single-basin-kitchen-sink-photo/> (1 page).

Amazon. (Jun. 30, 2016). "clickbasin £59 Best On Budget Basin | Easy Install Option | Counter Mounted Large Rectangle Bathroom Sink | 450mmx360mm | TRIESTE", located at <https://www.amazon.co.uk/Clickbasin-Trieste-Rectangular-Countertop-Ceramic/dp/B01HTSGKB8/ref>. (8 pages).

Amazon. (Oct. 13, 2016). "Double French Farmhouse Sink", located at <https://www.amazon.co.uk/Renaissance-Double-French-Farmhouse-Sink/dp/B01M5B5HRF/ref> (3 pages).

* cited by examiner

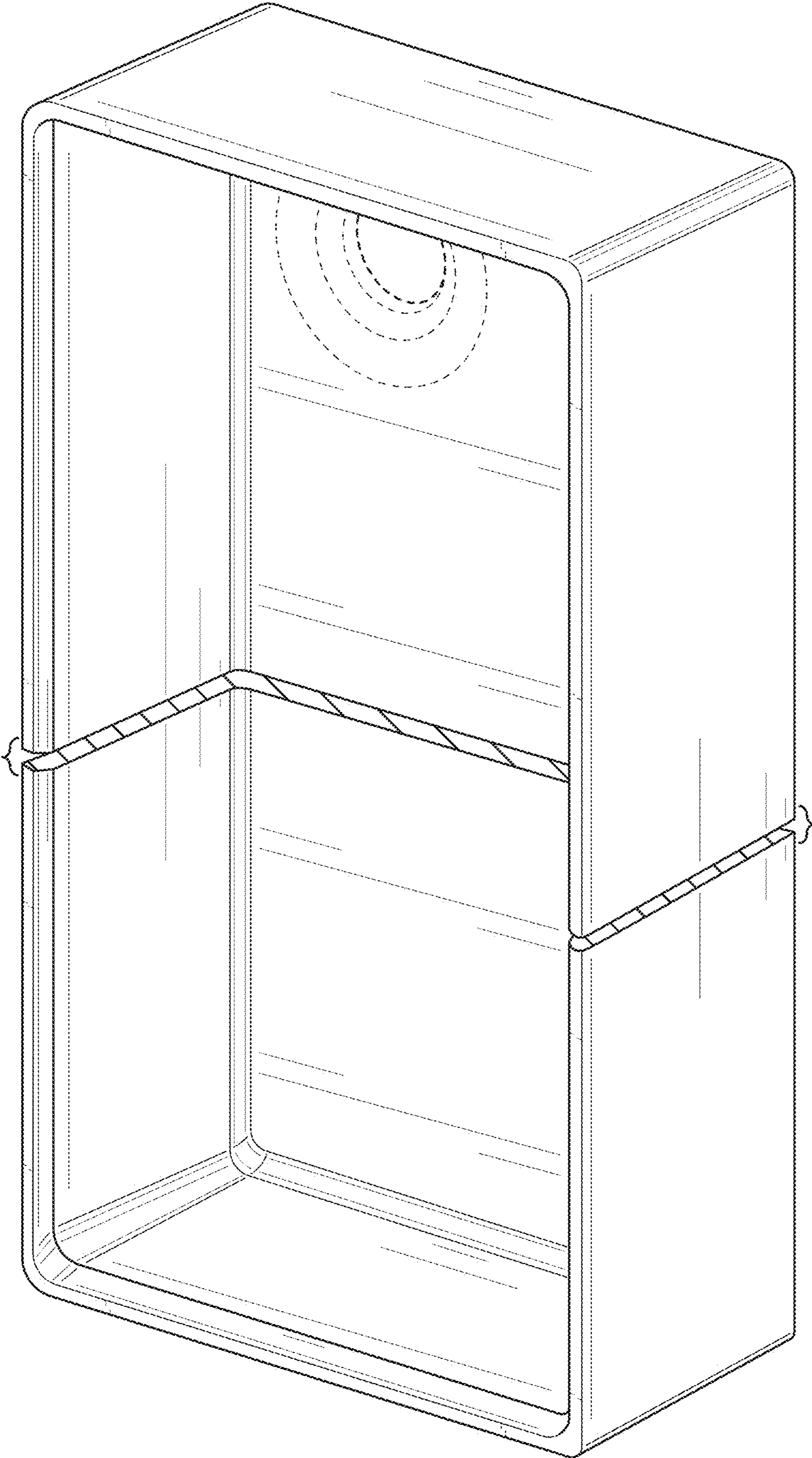

FIG. 1

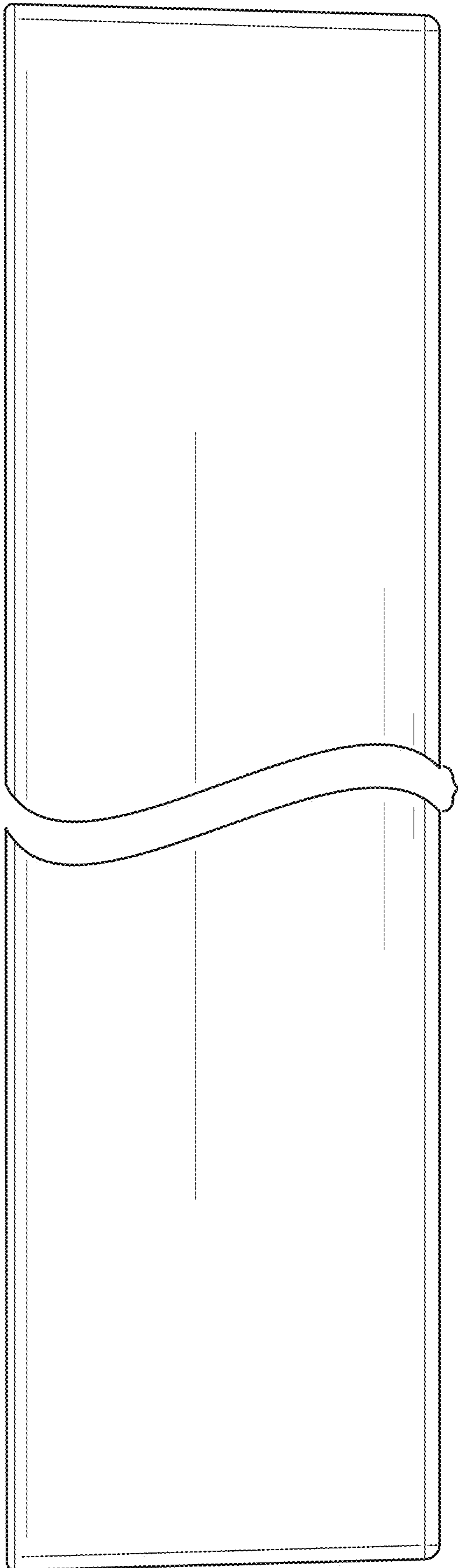

FIG. 2

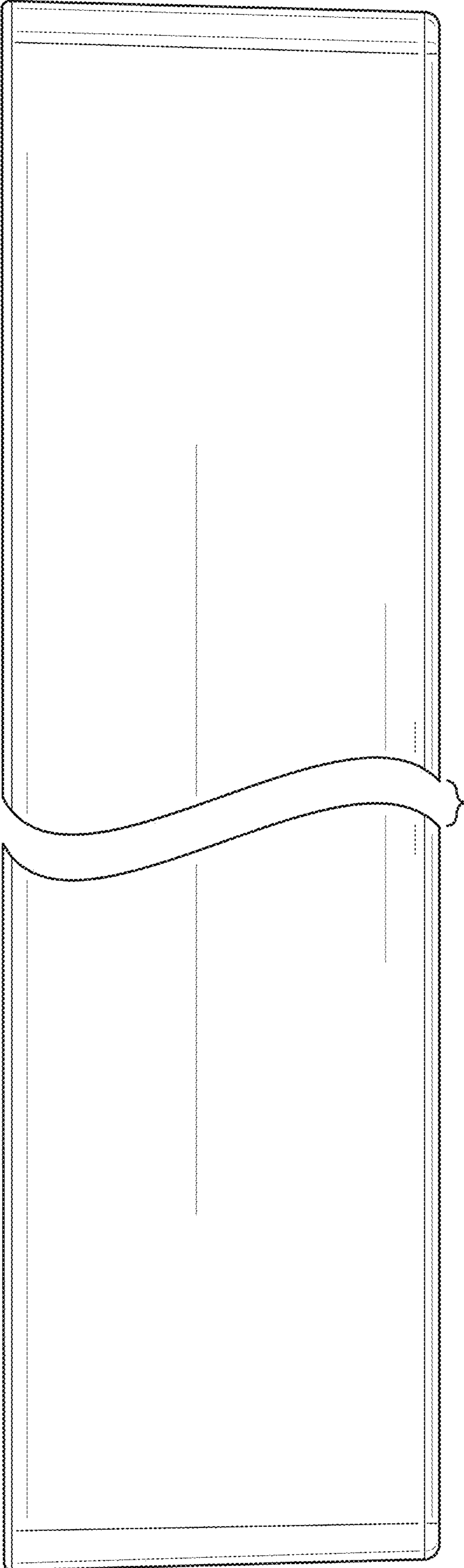

FIG. 3

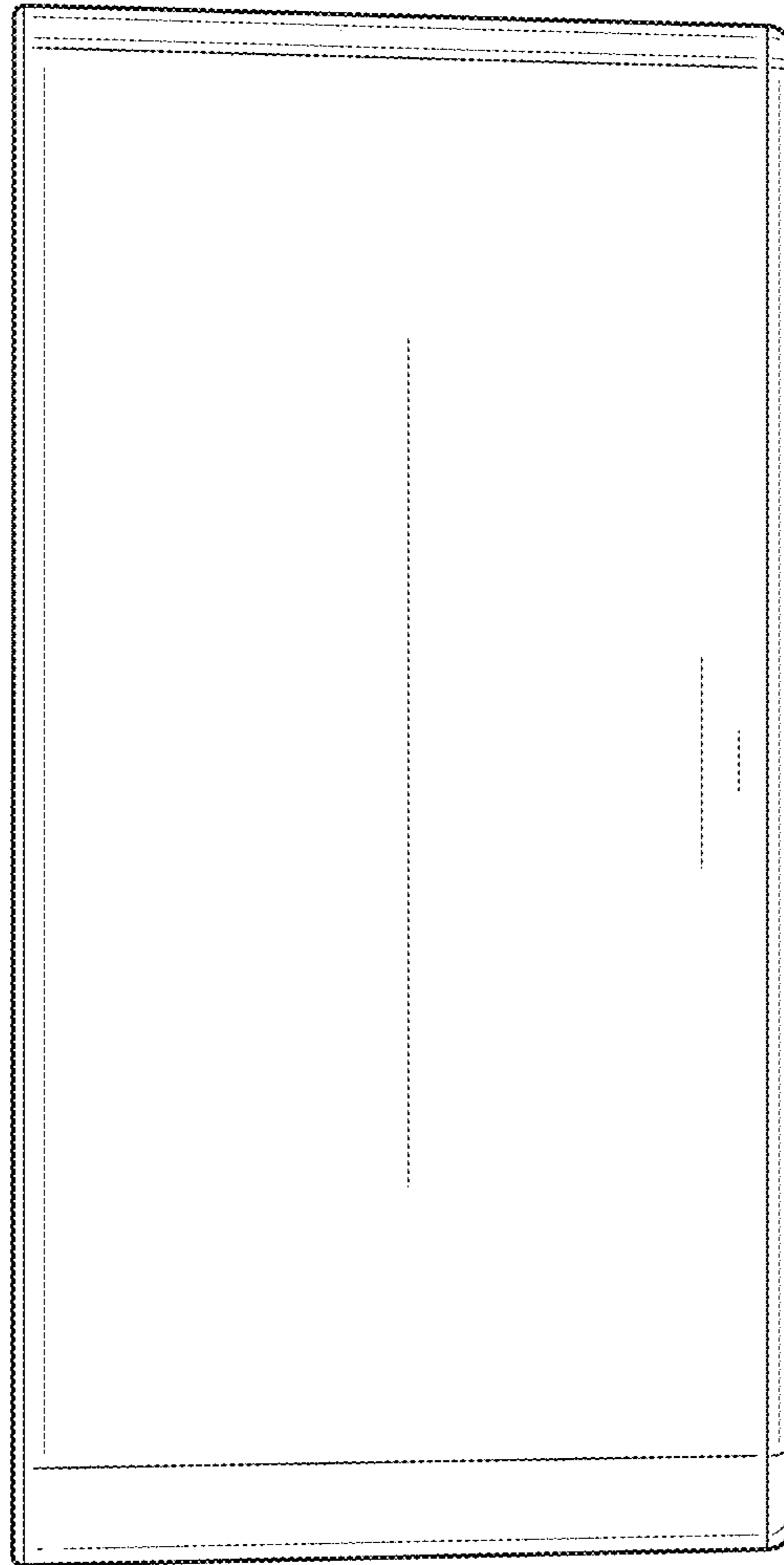

FIG. 4

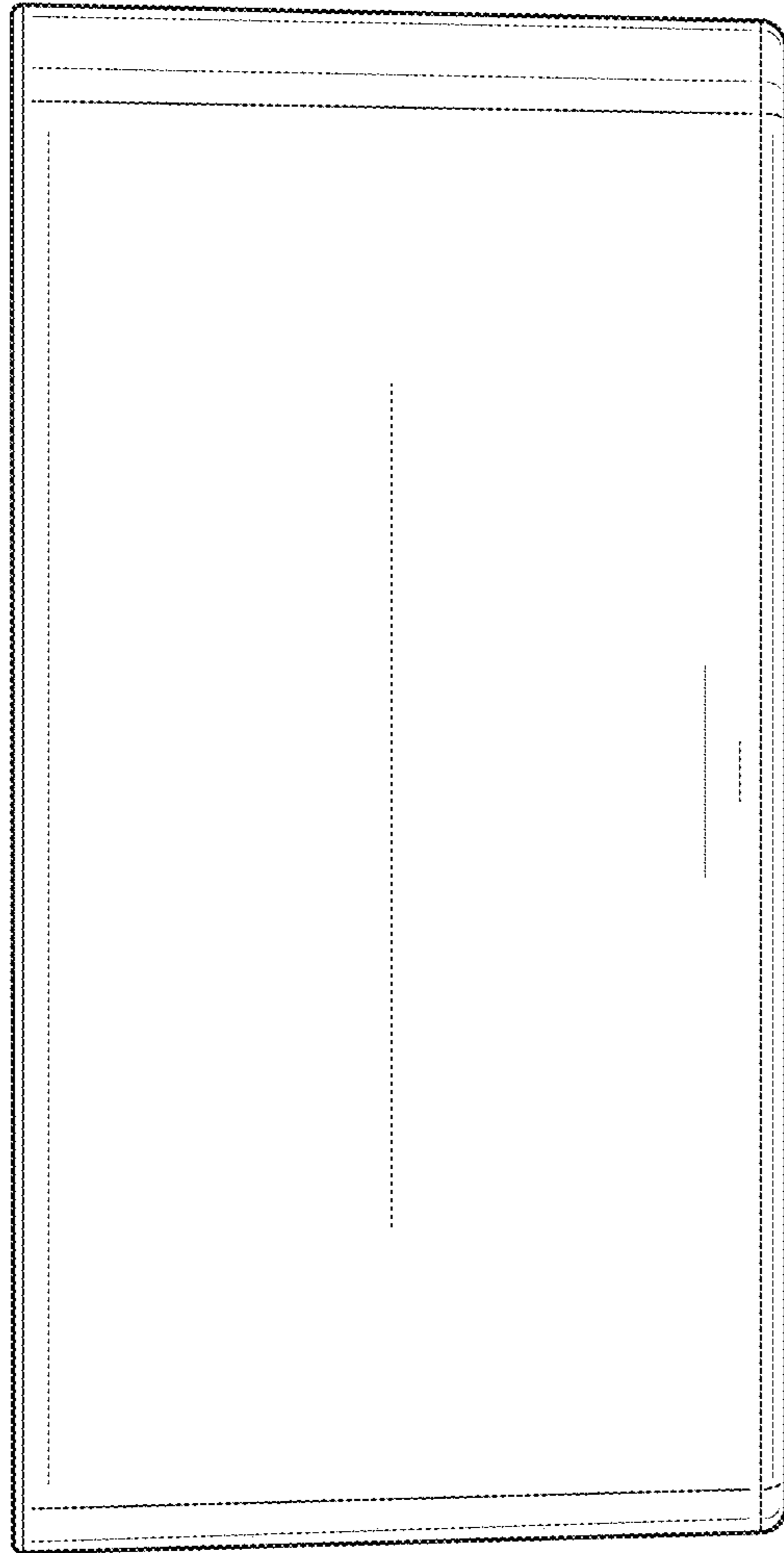

FIG. 5

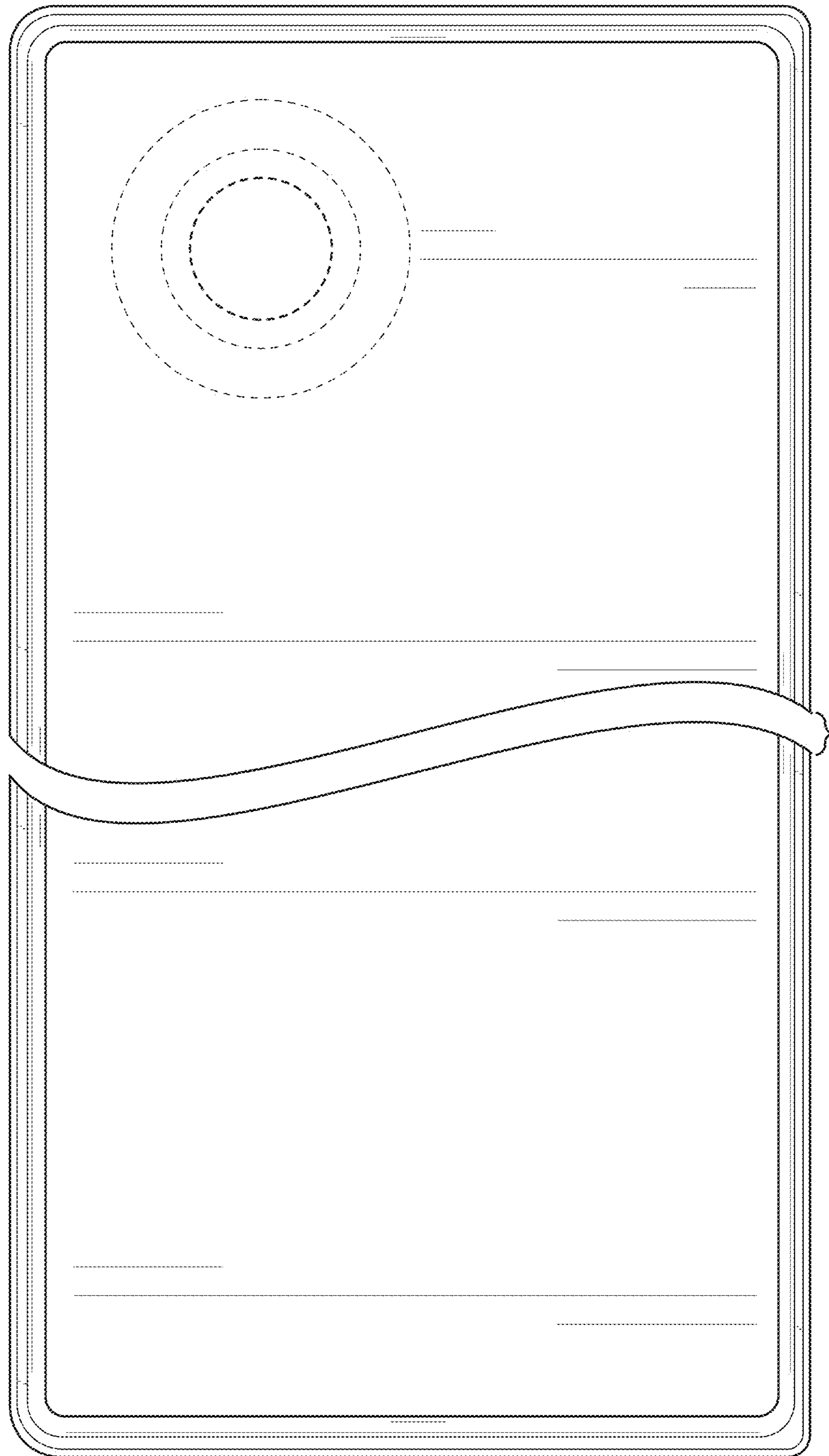

FIG. 6

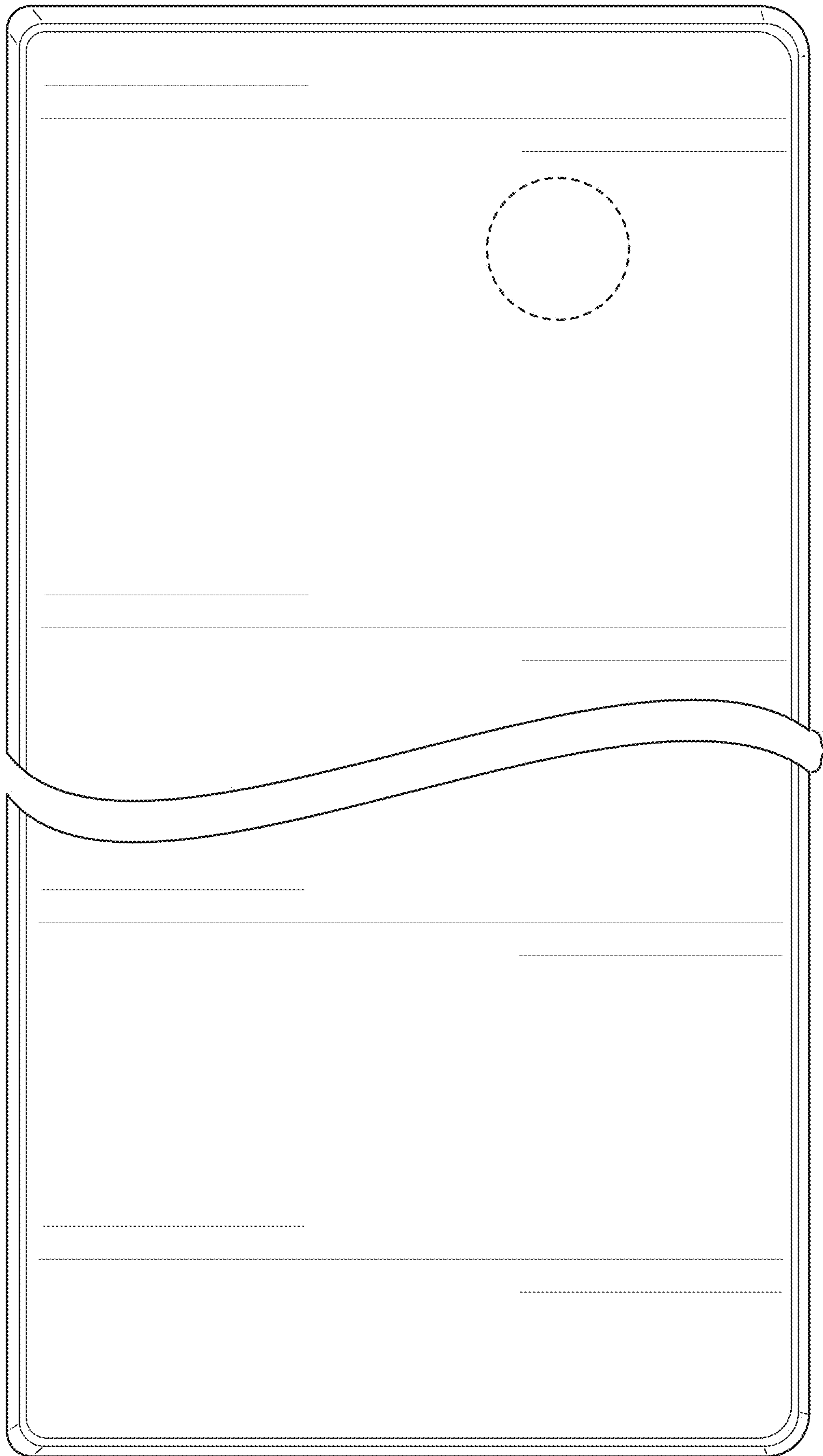

FIG. 7