



US00D954148S

(12) **United States Design Patent**
Stockwell et al.

(10) **Patent No.:** **US D954,148 S**
(45) **Date of Patent:** **** Jun. 7, 2022**

- (54) **SIGN**
- (71) Applicant: **Apple Inc.**, Cupertino, CA (US)
- (72) Inventors: **Julien Phillip Stockwell**, San Francisco, CA (US); **David Kahl Peschel**, San Carlos, CA (US); **Kully Kraig Mandon**, San Francisco, CA (US); **Christopher M. Green**, Woodside, CA (US)
- (73) Assignee: **Apple Inc.**, Cupertino, CA (US)
- (**) Term: **15 Years**
- (21) Appl. No.: **29/728,248**
- (22) Filed: **Mar. 17, 2020**
- (51) **LOC (13) Cl.** **20-03**
- (52) **U.S. Cl.**
USPC **D20/10**
- (58) **Field of Classification Search**
USPC D10/113.4; D14/125, 126, 307, 336, D14/371; D20/10, 19, 22, 27, 39, 41, 42, D20/99; D26/1, 2, 4, 25, 27, 31, 72, 80
CPC G06K 2209/25; G06K 9/3266; G06K 2209/00; G09F 23/00; G06T 11/00; G06T 11/60; G06Q 30/0251; B65D 2203/00
See application file for complete search history.

- (56) **References Cited**
U.S. PATENT DOCUMENTS

D41,125 S	1/1911	Klee
D144,844 S	5/1945	Dunham
D212,886 S	12/1968	Gordon
D218,325 S	8/1970	Sherman
3,740,881 A	6/1973	Finger
4,116,509 A	9/1978	Smith
D250,868 S	1/1979	Ornatek
4,144,664 A	3/1979	De Korte

- D262,664 S 1/1982 Willits, Jr.
- D264,731 S 6/1982 Shuman
- D274,203 S 6/1984 Everett
- D279,201 S 6/1985 Shuman
- D321,100 S 10/1991 Dorrell
- D323,944 S 2/1992 Maas
- D324,701 S 3/1992 Capps
- D335,963 S 6/1993 Tracey
- D347,755 S 6/1994 Houston
- D351,863 S 10/1994 Sarkisian et al.
- D354,638 S 1/1995 Todd et al.
- D359,488 S 6/1995 Hui
- D362,236 S 9/1995 Dann et al.
- D365,947 S 1/1996 Howard
- D369,044 S 4/1996 Lechleiter et al.
- 5,577,817 A 11/1996 Reynolds
- D377,012 S 12/1996 Oslund
- 5,607,070 A 3/1997 Hellyer
- D392,686 S 3/1998 Sarkisian et al.
- D395,677 S 6/1998 Gongora et al.

(Continued)

Primary Examiner — Catherine Ho
(74) *Attorney, Agent, or Firm* — Sterne, Kessler, Goldstein & Fox P.L.L.C.

(57) **CLAIM**

The ornamental design for a sign, as shown and described.

DESCRIPTION

FIG. 1 is a top front perspective view of a sign showing the claimed design;
FIG. 2 is a bottom rear perspective view thereof;
FIG. 3 is a front view thereof;
FIG. 4 is a rear view thereof;
FIG. 5 is a left side view thereof;
FIG. 6 is a right side view thereof;
FIG. 7 is a top view thereof; and,
FIG. 8 is a bottom view thereof.
The broken lines in the figures show portions of the sign that form no part of the claimed design.

1 Claim, 6 Drawing Sheets

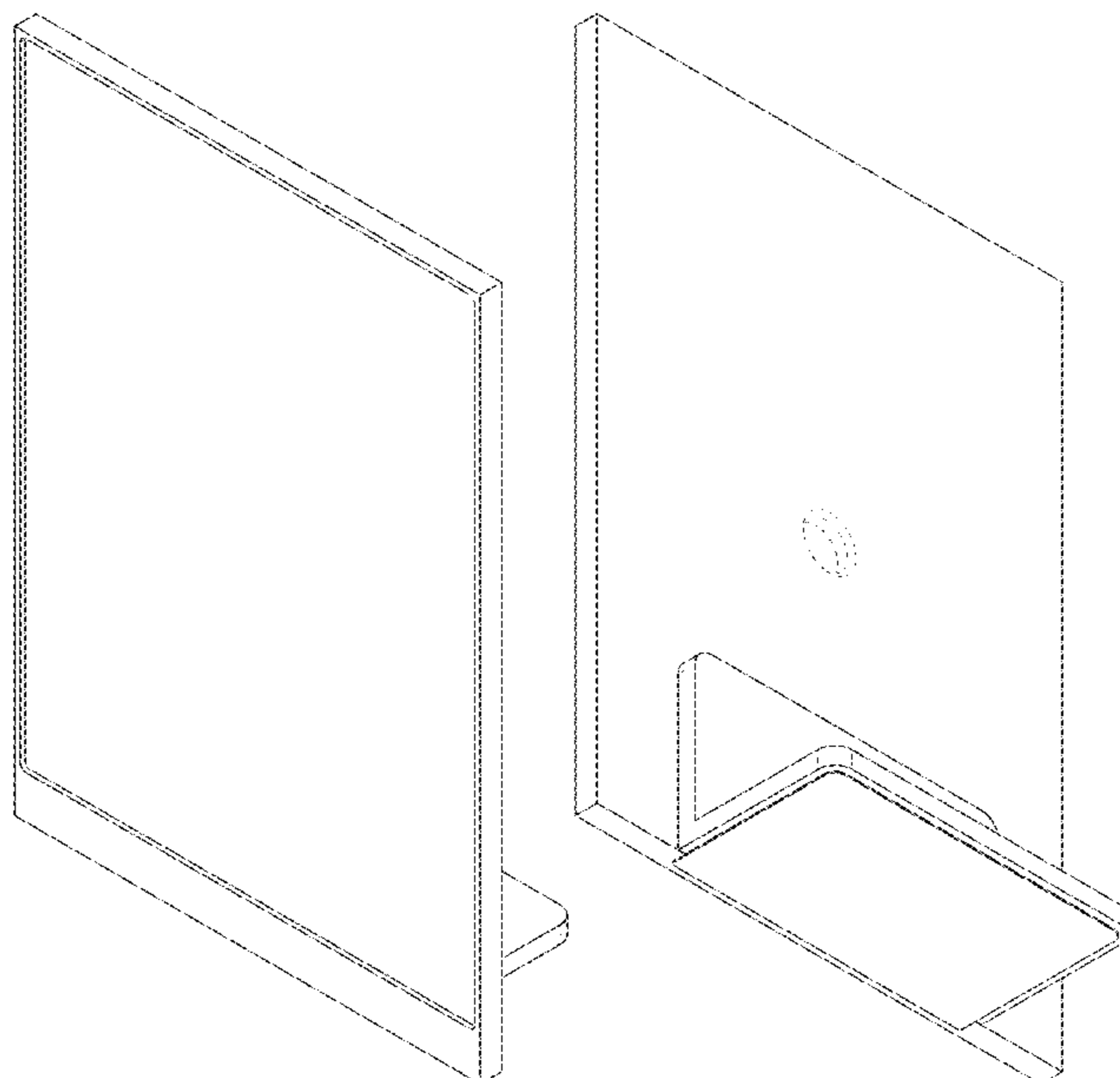

(56)

References Cited

U.S. PATENT DOCUMENTS

D396,251 S 7/1998 Mortensen
 D397,562 S 9/1998 DePottay et al.
 D400,737 S 11/1998 DePottay et al.
 D408,383 S 4/1999 Carter et al.
 5,890,607 A 4/1999 Maglione
 D410,036 S 5/1999 Washington
 D434,451 S 11/2000 Grimshaw
 D434,929 S 12/2000 Heiny et al.
 6,164,467 A 12/2000 DePottay et al.
 6,170,678 B1 1/2001 de la Fuente
 D443,308 S 6/2001 Kovell
 6,357,609 B1 3/2002 Van Noord et al.
 D463,499 S 9/2002 Marcos
 D465,529 S * 11/2002 Hummell D20/40
 D468,134 S 1/2003 Oikawa
 D470,892 S 2/2003 Linko, Sr.
 D478,582 S 8/2003 Becker et al.
 D497,485 S 10/2004 Resultan
 D501,284 S 1/2005 Mount
 D509,543 S 9/2005 Hillstrom et al.
 7,228,654 B2 6/2007 Stravitz
 D559,577 S 1/2008 Quinn
 D590,630 S 4/2009 Singler et al.
 D591,531 S 5/2009 Sparkowski
 D592,422 S 5/2009 Rheault
 D610,832 S 3/2010 Rheault
 D632,903 S 2/2011 Paul
 D637,421 S 5/2011 Theisen et al.
 D642,360 S 8/2011 West
 D642,390 S 8/2011 West
 D642,824 S 8/2011 Theisen et al.
 D649,192 S 11/2011 Beukema et al.
 D657,978 S 4/2012 Hamm et al.
 D660,361 S 5/2012 Carver, Jr.
 D661,123 S * 6/2012 Curbbun D6/675.1
 D661,124 S 6/2012 Curbbun et al.
 D671,535 S 11/2012 Terashima et al.
 D676,430 S 2/2013 Blaser
 D678,696 S 3/2013 Hamm et al.
 D679,521 S 4/2013 Hamm et al.
 D682,581 S 5/2013 Kikkert et al.
 D684,792 S 6/2013 Kikkert et al.
 D693,156 S 11/2013 Hamm et al.
 8,602,227 B1 12/2013 McDonald
 D700,901 S 3/2014 Giglio et al.
 D708,459 S * 7/2014 Heirakuji D6/675
 D709,952 S 7/2014 Logan et al.
 D712,867 S * 9/2014 Vats D14/138 AB
 D713,658 S 9/2014 Tio et al.
 D717,085 S 11/2014 Trinh et al.
 D717,756 S * 11/2014 Park D14/126
 D717,785 S * 11/2014 Winston D14/307
 D722,313 S 2/2015 Birgeoglu
 D722,794 S 2/2015 Luong
 D723,025 S 2/2015 Birgeoglu

D723,026 S 2/2015 Birgeoglu
 D725,108 S 3/2015 Yeon
 D725,947 S 4/2015 Tio et al.
 D727,995 S 4/2015 Vilcovsky
 D730,852 S 6/2015 Park et al.
 D734,965 S 7/2015 Tio et al.
 D736,169 S * 8/2015 Kim D14/126
 D741,091 S 10/2015 Tio et al.
 D742,455 S 11/2015 Denby et al.
 D753,754 S 4/2016 Vilcovsky et al.
 D758,331 S * 6/2016 Seo D14/126
 D766,853 S * 9/2016 Seo D14/126
 D767,922 S 10/2016 Jussila
 D769,651 S 10/2016 Tio et al.
 D770,203 S 11/2016 Thaler et al.
 D773,422 S * 12/2016 Han D14/126
 D774,484 S * 12/2016 Han D14/126
 D779,240 S 2/2017 Tio et al.
 D790,260 S 6/2017 Tio et al.
 D795,751 S 8/2017 Roth et al.
 D796,234 S 9/2017 Thaler et al.
 D807,086 S 1/2018 Tio et al.
 D807,846 S * 1/2018 Kim D14/126
 D813,831 S * 3/2018 Han D14/126
 D824,702 S 8/2018 Tio et al.
 D835,056 S * 12/2018 Won D14/126
 D835,594 S * 12/2018 Won D14/126
 D835,595 S * 12/2018 Won D14/126
 D847,111 S * 4/2019 Won D14/126
 D852,274 S * 6/2019 Lim D20/39
 D867,035 S * 11/2019 Brugger D6/675
 D868,014 S * 11/2019 Kim D14/126
 D886,196 S * 6/2020 Lee D20/39
 D899,388 S * 10/2020 Park D14/126
 D899,390 S * 10/2020 Park D14/126
 D900,814 S * 11/2020 Lee D14/371
 D906,329 S * 12/2020 Wu D14/345
 D908,650 S * 1/2021 Cho D14/126
 D911,300 S * 2/2021 Park D14/126
 10,925,195 B2 * 2/2021 Kim H05K 7/20963
 D917,462 S * 4/2021 Widiaman D14/341
 D920,323 S * 5/2021 Lee D14/307
 D924,188 S * 7/2021 Park D14/126
 D924,869 S * 7/2021 Yang D20/15
 D925,484 S * 7/2021 Easton D14/126
 D926,147 S * 7/2021 Lim D14/126
 D930,604 S * 9/2021 Pyo D14/126
 D933,654 S * 10/2021 Chung D14/371
 D936,027 S * 11/2021 Pyo D14/126
 D937,612 S * 12/2021 Brugger D6/675
 2005/0279033 A1 12/2005 Faber et al.
 2006/0098425 A1 * 5/2006 Waterhouse G09F 1/14
 362/190
 2007/0170823 A1 7/2007 Stannis et al.
 2017/0127832 A1 5/2017 Klacking
 2021/0029839 A1 * 1/2021 Kwon G09F 9/301

* cited by examiner

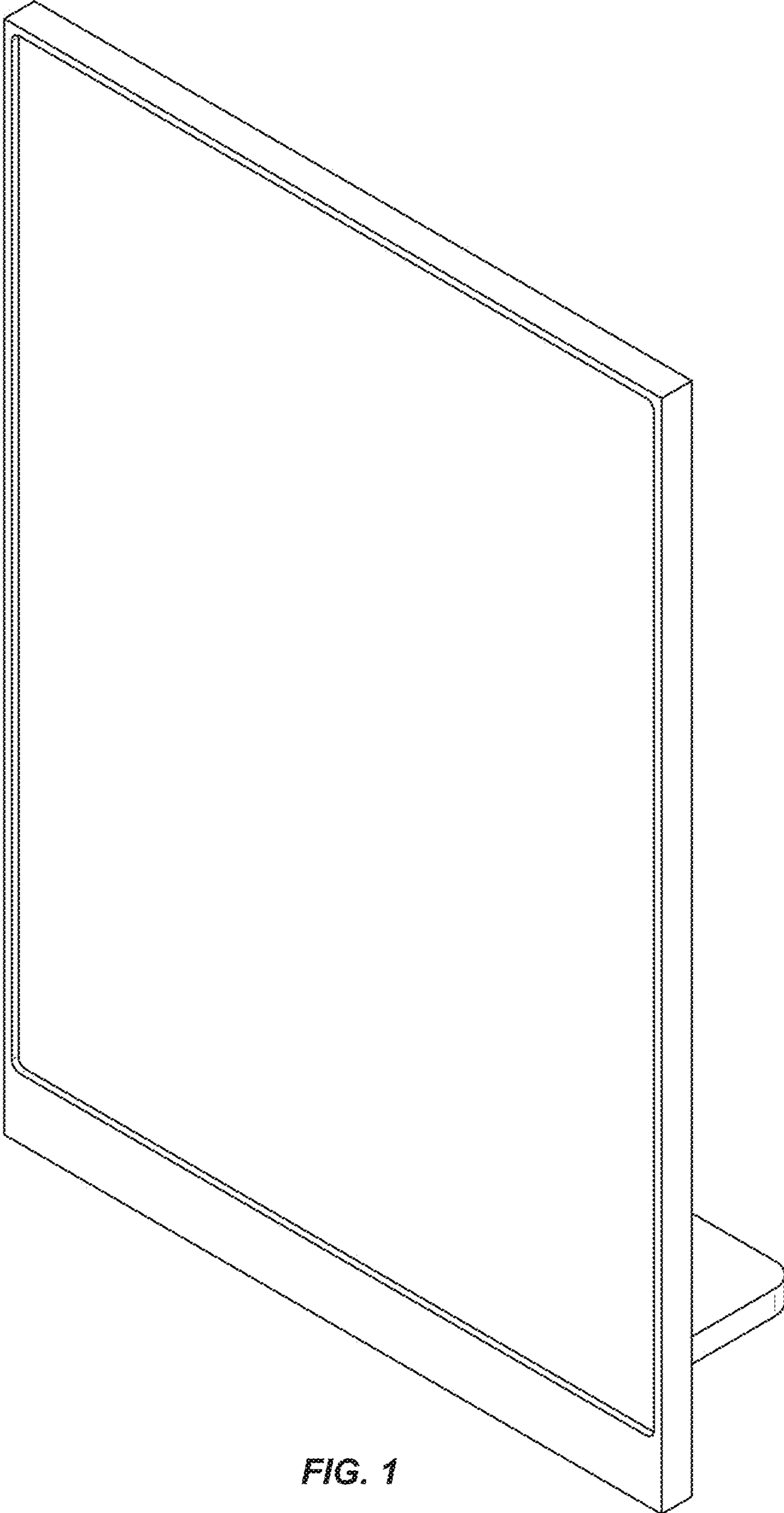

FIG. 1

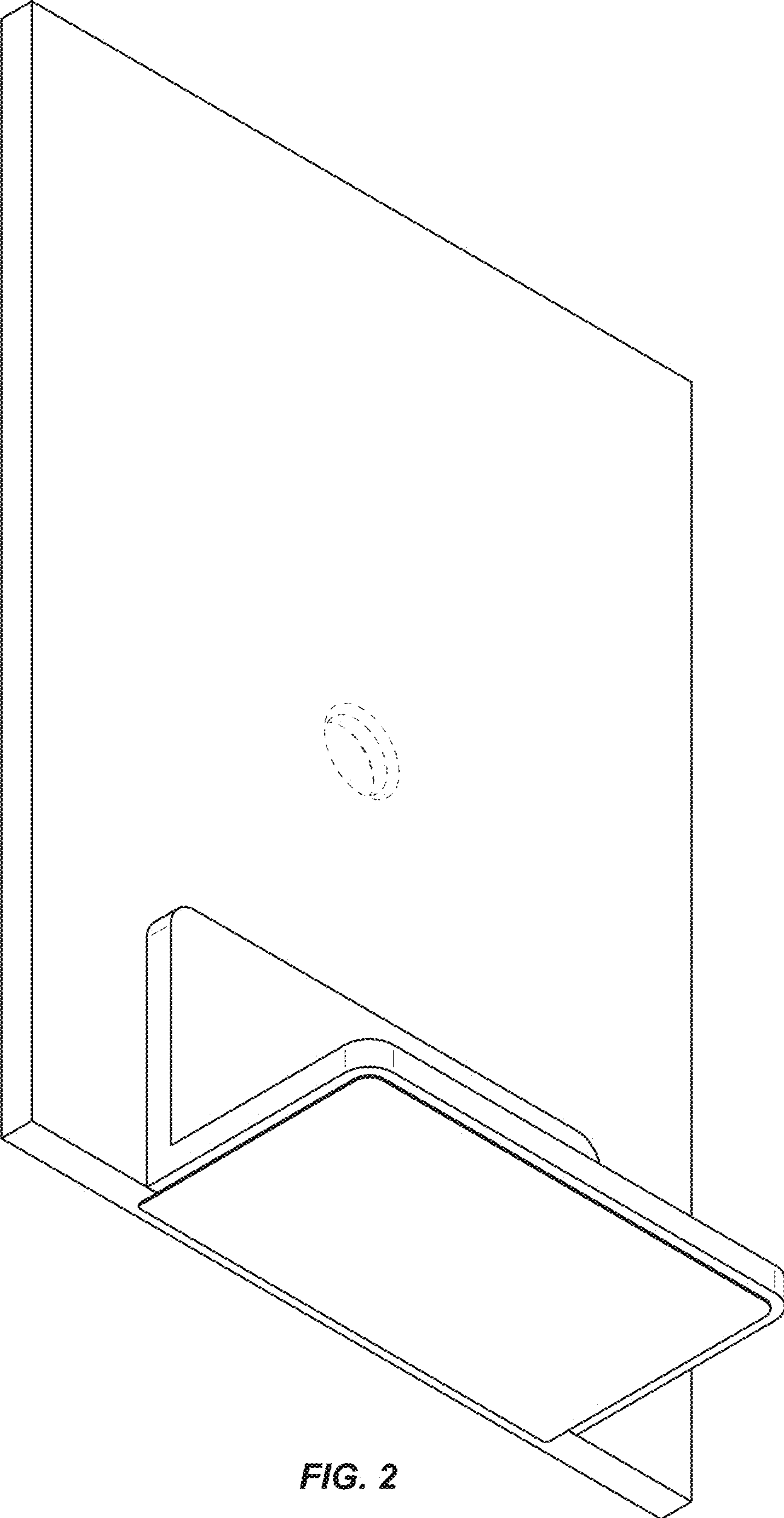

FIG. 2

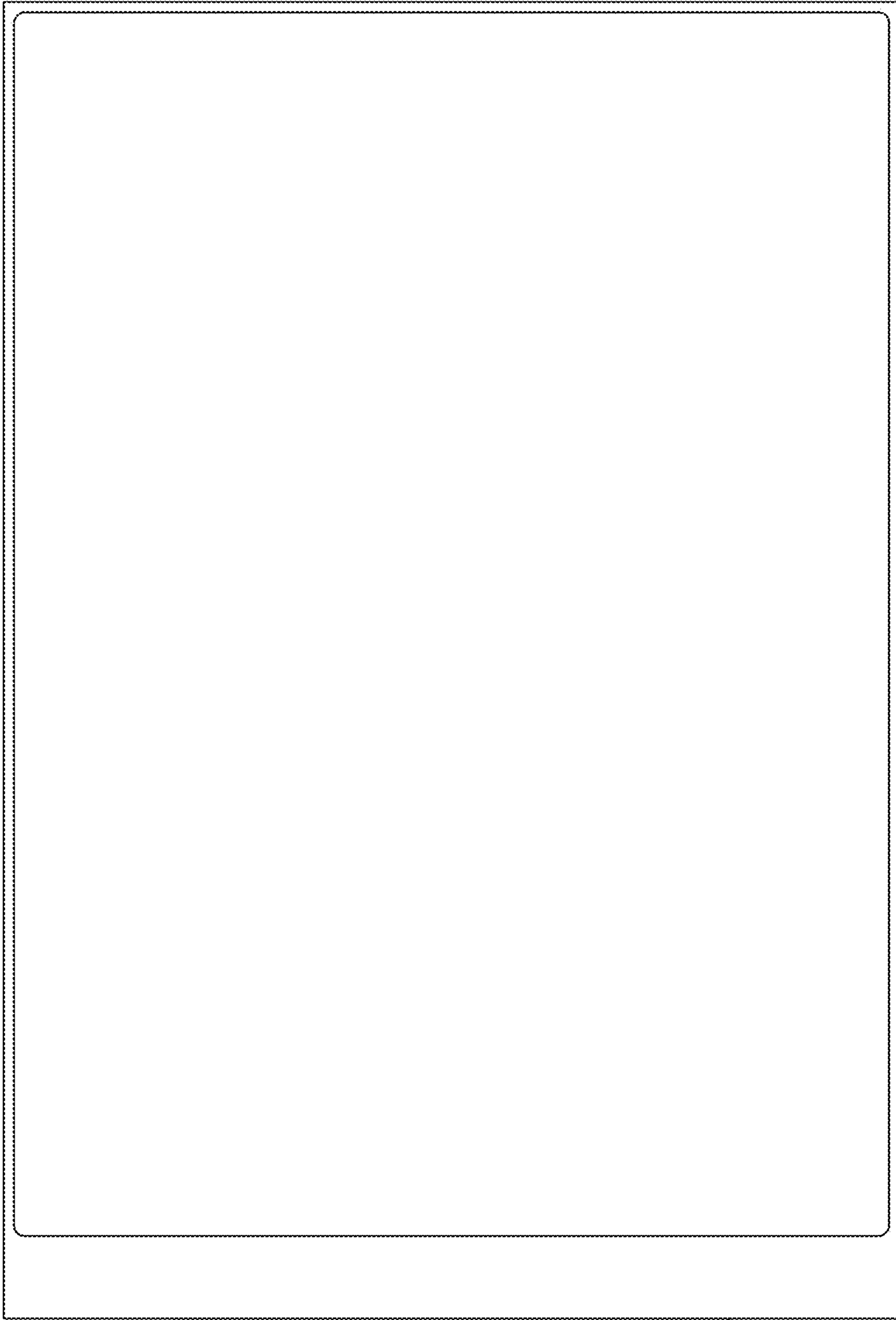

FIG. 3

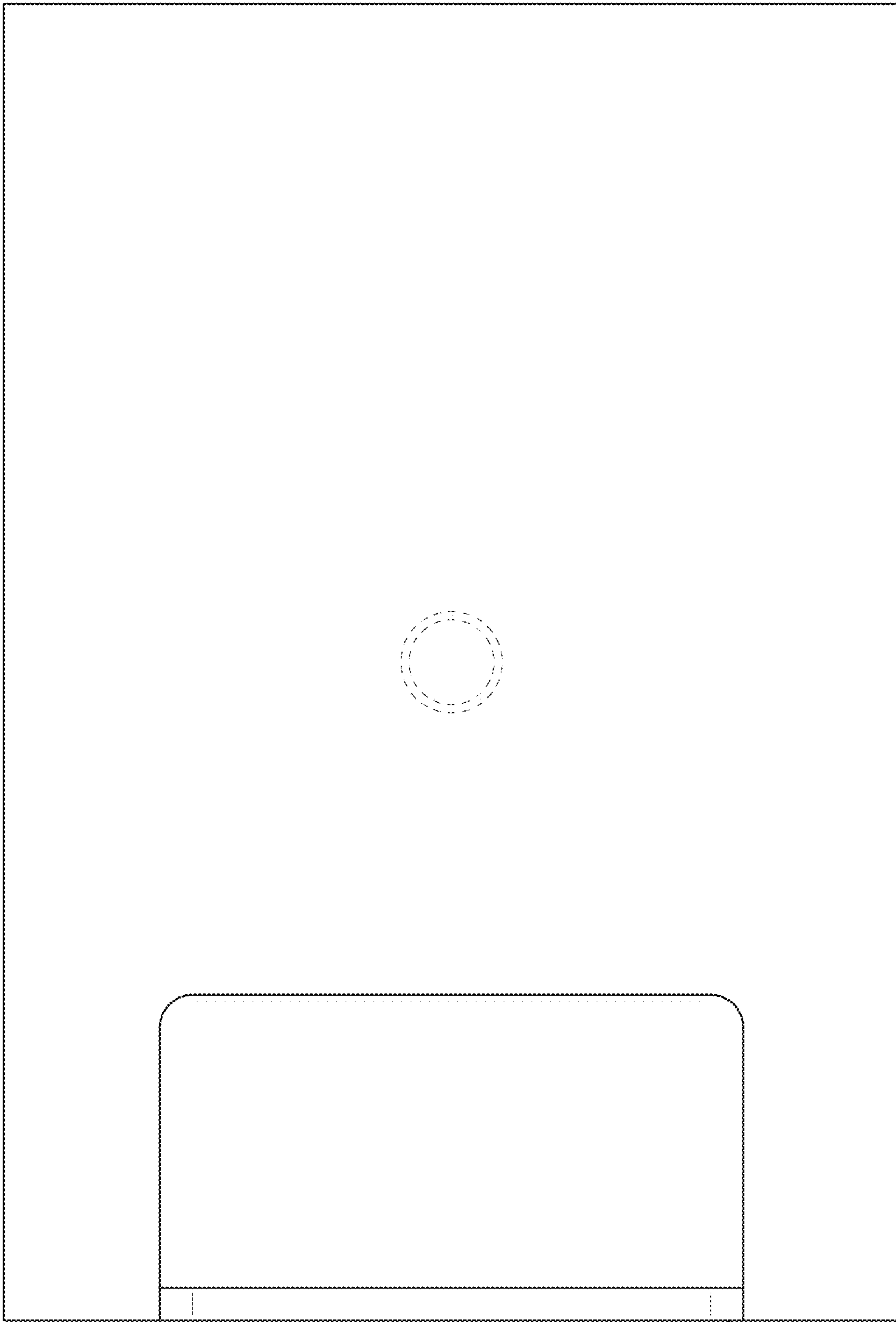

FIG. 4

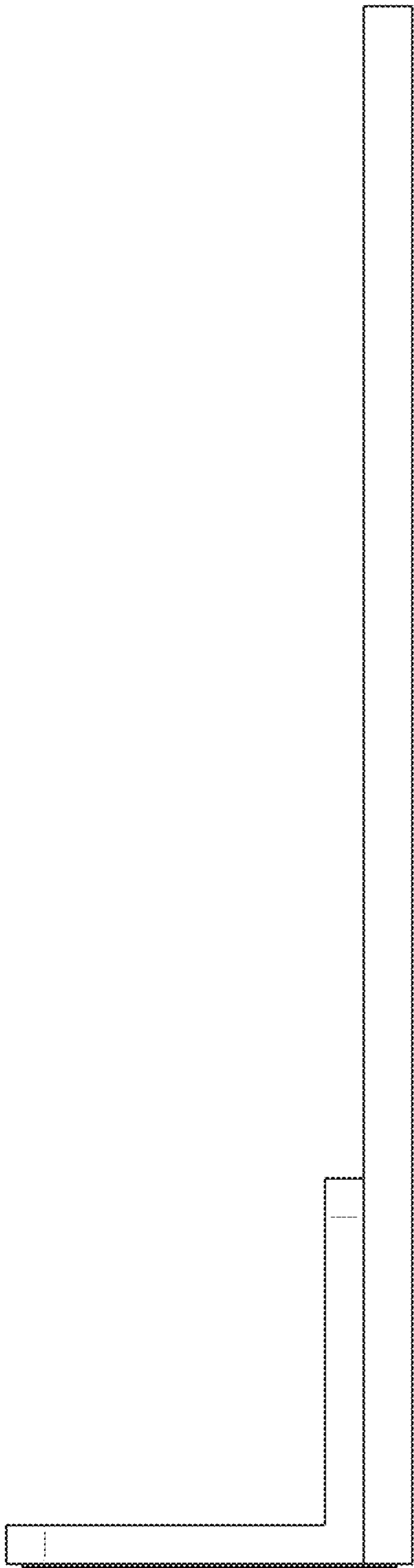

FIG. 5

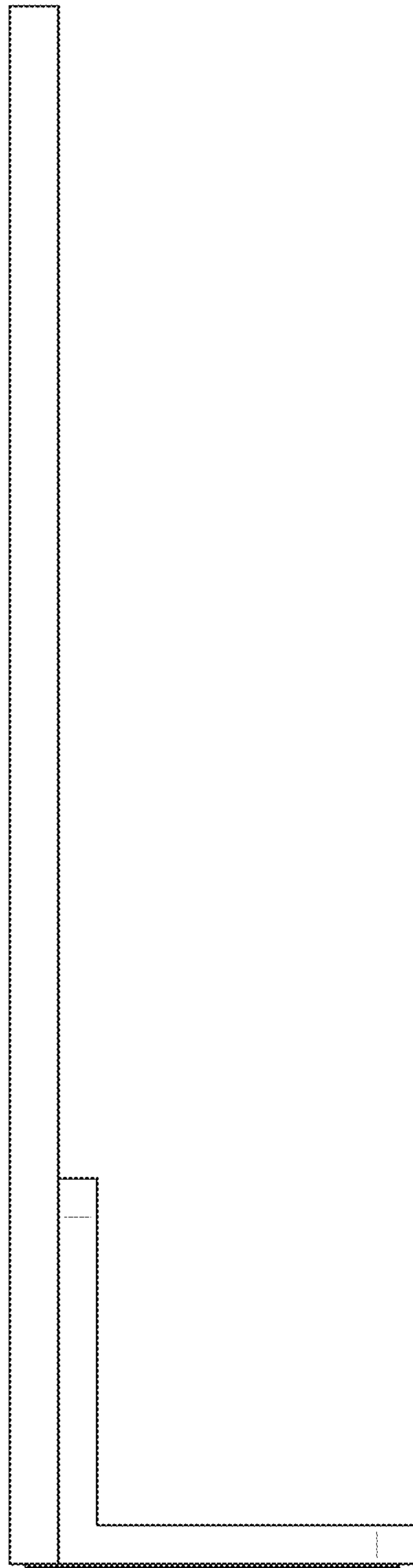

FIG. 6

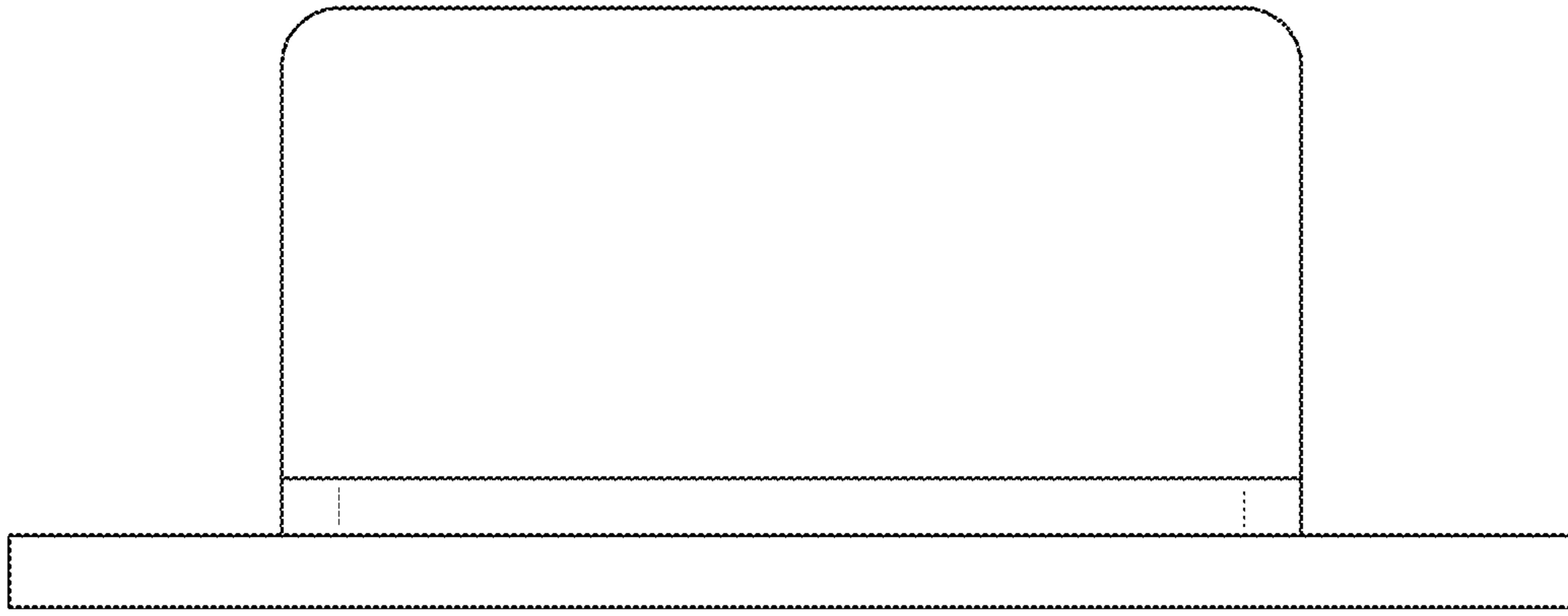

FIG. 7

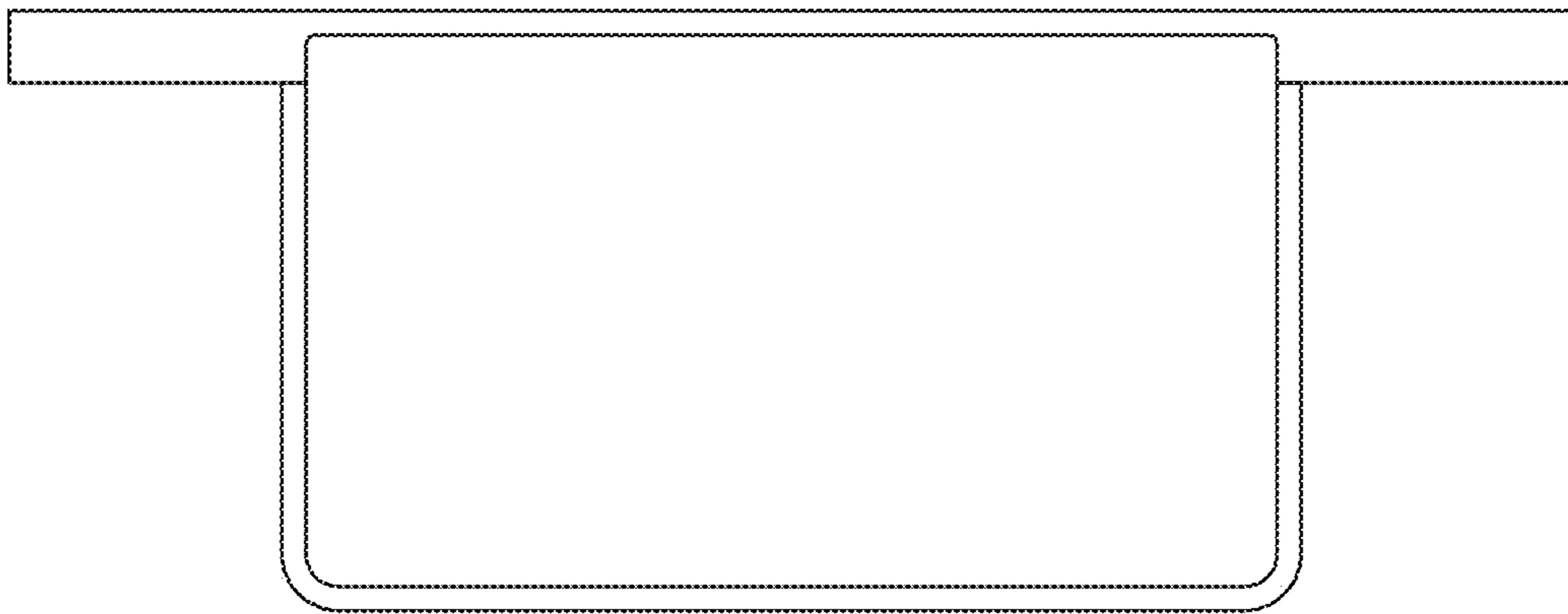

FIG. 8