



US00D953877S

(12) **United States Design Patent**
Neihart

(10) **Patent No.:** **US D953,877 S**

(45) **Date of Patent:** **** Jun. 7, 2022**

(54) **FLARED YARD WASTE BAG**

(56) **References Cited**

(71) Applicant: **David Neihart**, Prairie Village, KS
(US)

U.S. PATENT DOCUMENTS

(72) Inventor: **David Neihart**, Prairie Village, KS
(US)

D349,992	S	*	8/1994	Brohan	D34/5
D401,027	S	*	11/1998	Mueller	D34/6
6,131,759	A	*	10/2000	Young	B65D 33/02
						220/495.11
D450,413	S	*	11/2001	Howard	D34/1
6,494,619	B1	*	12/2002	Sulpizio	B65F 1/1415
						141/390
8,720,833	B2	*	5/2014	Jack	B65B 67/1255
						248/101

(**) Term: **15 Years**

(21) Appl. No.: **29/761,645**

(22) Filed: **Dec. 10, 2020**

* cited by examiner

(51) **LOC (13) Cl.** **09-05**

Primary Examiner — Abraham Bahta

(52) **U.S. Cl.**
USPC **D9/703**

(74) *Attorney, Agent, or Firm* — Dale J. Ream

(58) **Field of Classification Search**
USPC D9/702-714, 719, 738-740, 517-518,
D9/522, 416, 435, 444, 460, 455, 414,
D9/499, 431-432; D7/560-562;
206/434, 426-427, 429-430, 485, 485.1,
206/499, 508, 431, 418-422, 588-594;
229/117.3, 185, 121, 122, 200, 207, 236,
229/87.01; 220/23.83; 150/100-118;
294/137, 152, 1.1, 55; 383/6, 10, 14, 20,
383/40, 33, 104-105, 117, 108, 120, 93,
383/121.1, 127; 428/34.3; 248/99, 95,
248/100; 241/62, 55, 100
CPC B65D 33/00; B65D 33/06; B65D 33/065;
B65D 33/14; B65D 33/1683; B65D
33/12; B65D 31/00; B65D 31/04; B65D
31/10; B65D 31/12; B65D 88/16; B65D
88/22; A45C 3/04; A45C 3/10; B65F
1/10; B65F 1/1415

(57) **CLAIM**

The ornamental design for a flared yard waste bag, as shown and described.

DESCRIPTION

FIG. 1 is a perspective view of a flared yard waste bag showing my new design;
FIG. 2 is a front elevation view thereof;
FIG. 3 is a back elevation view thereof;
FIG. 4 is a left side elevation view thereof;
FIG. 5 is a right side elevation view thereof;
FIG. 6 is a top plan view thereof; and,
FIG. 7 is a bottom plan view thereof.
In the drawings, the broken lines represent unclaimed environment subject matter and form no part of the claimed design.

See application file for complete search history.

1 Claim, 6 Drawing Sheets

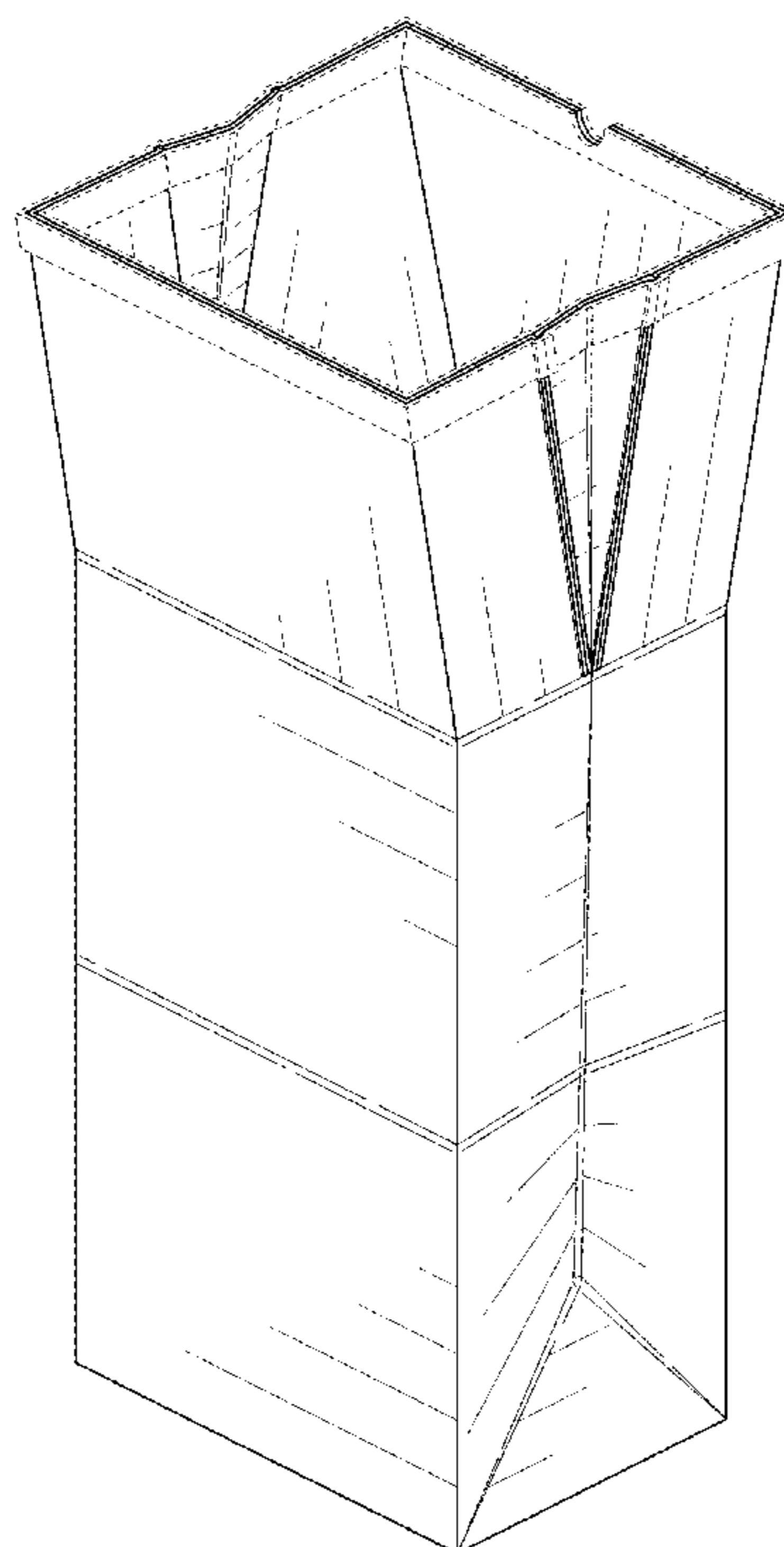

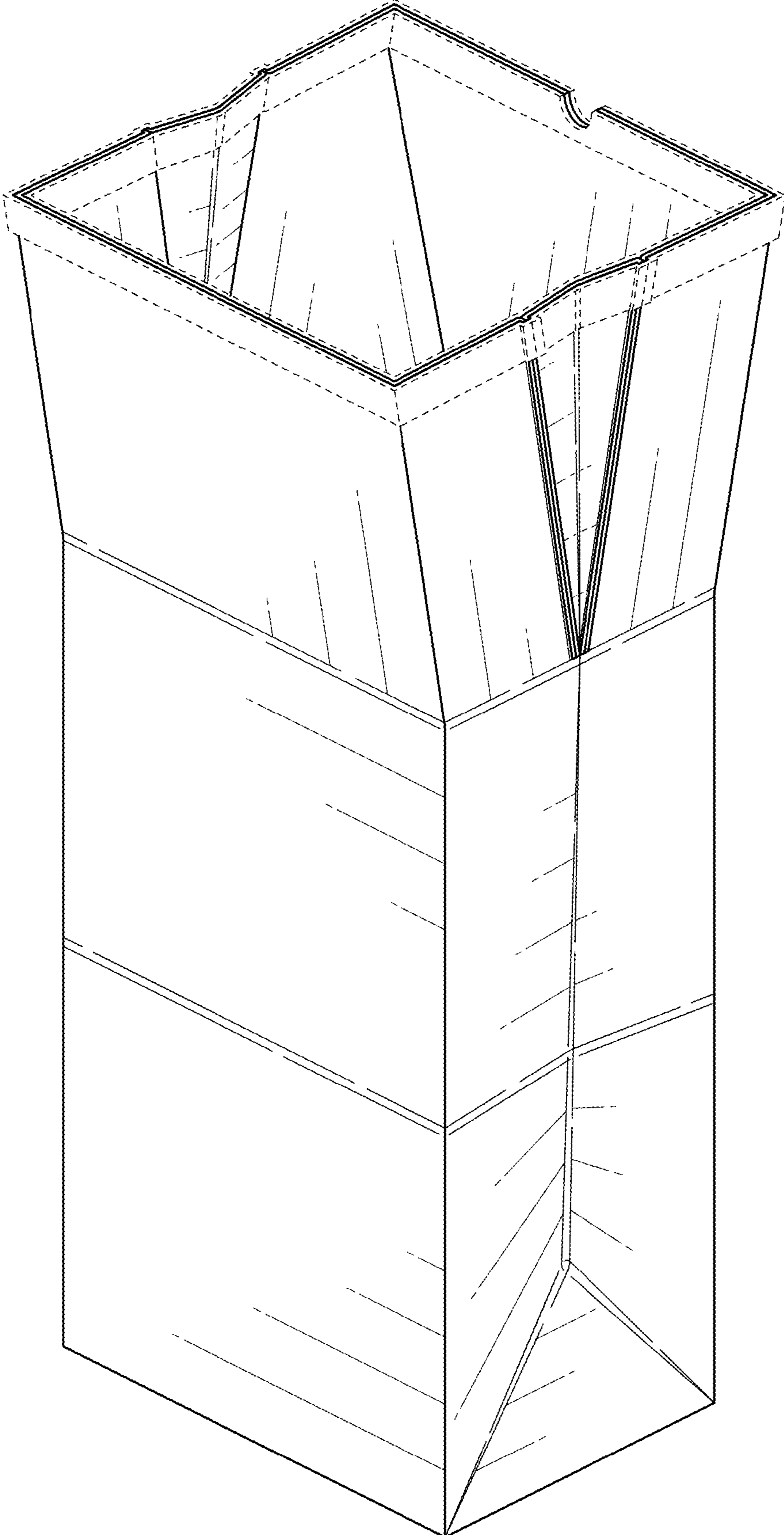

FIG. 1

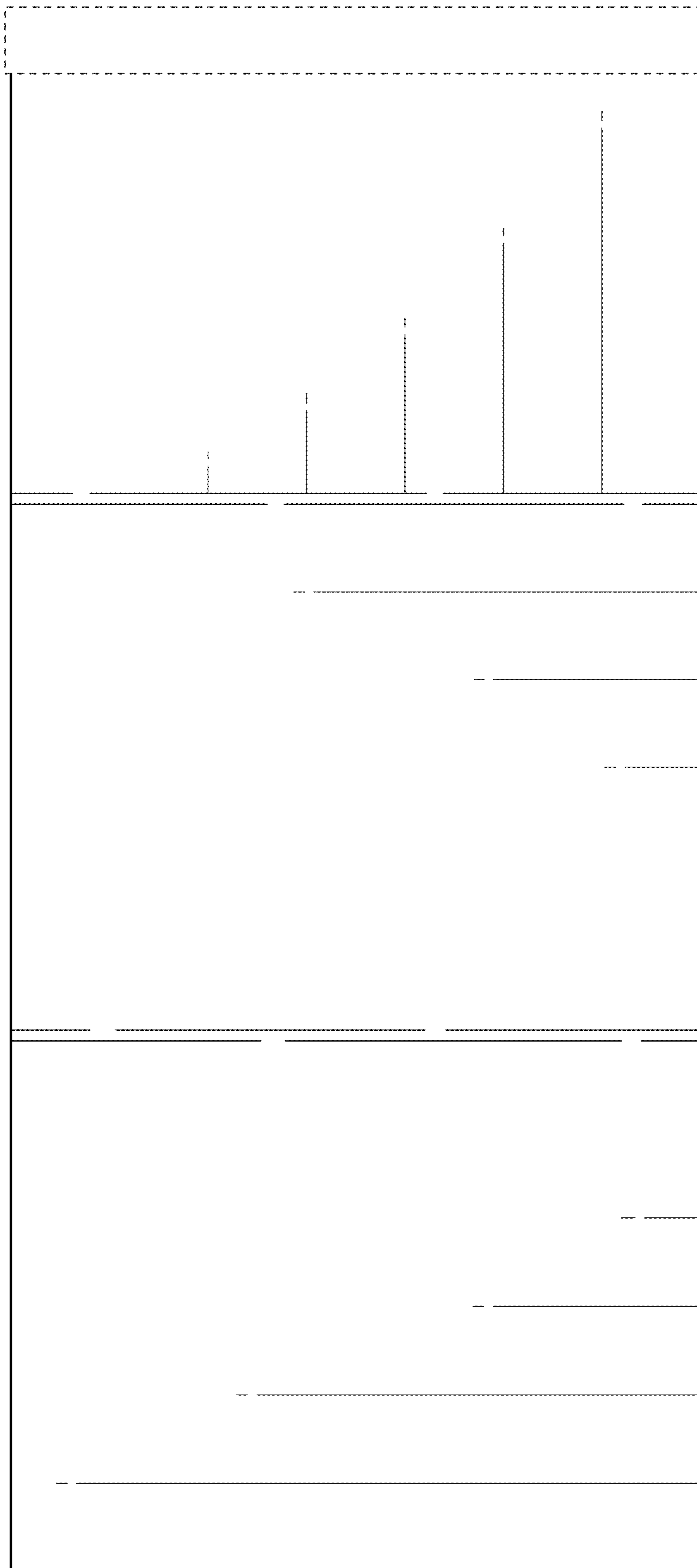

FIG. 2

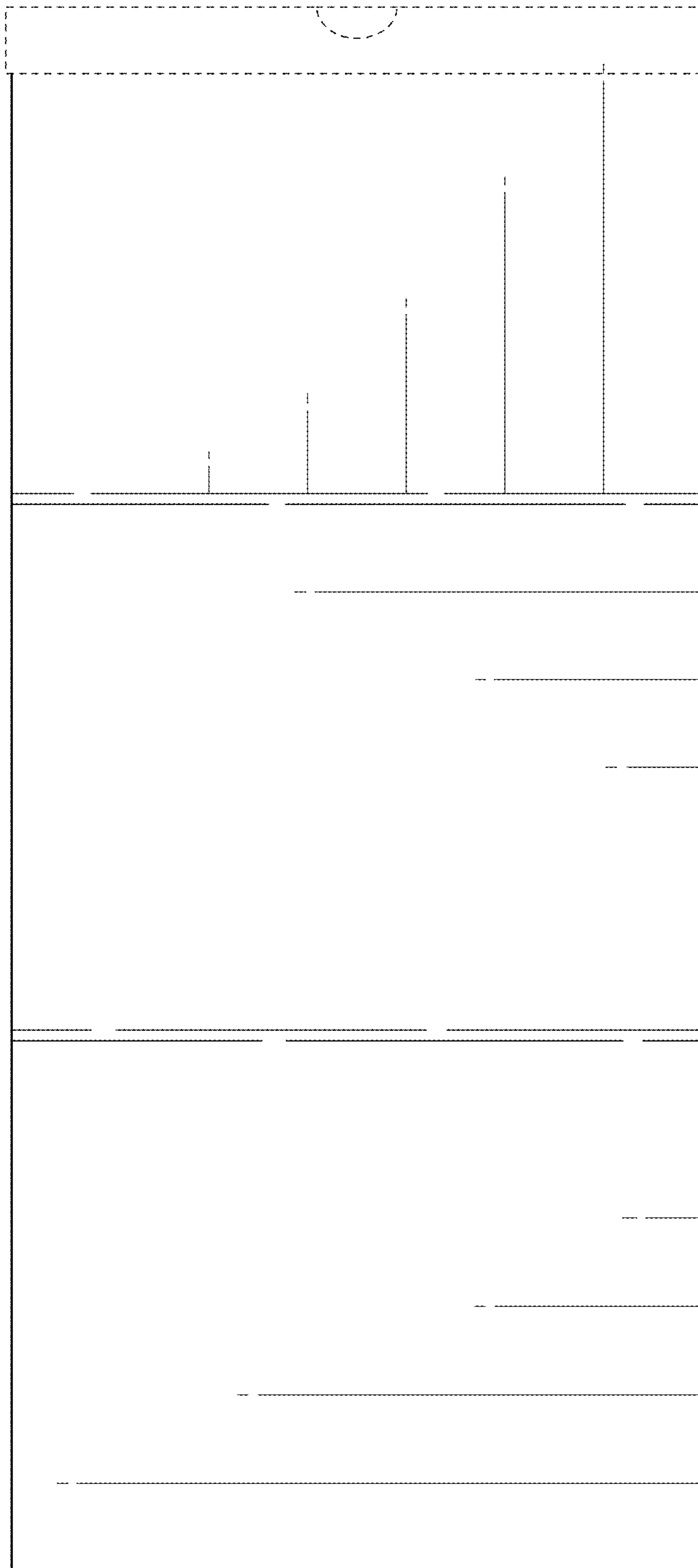

FIG. 3

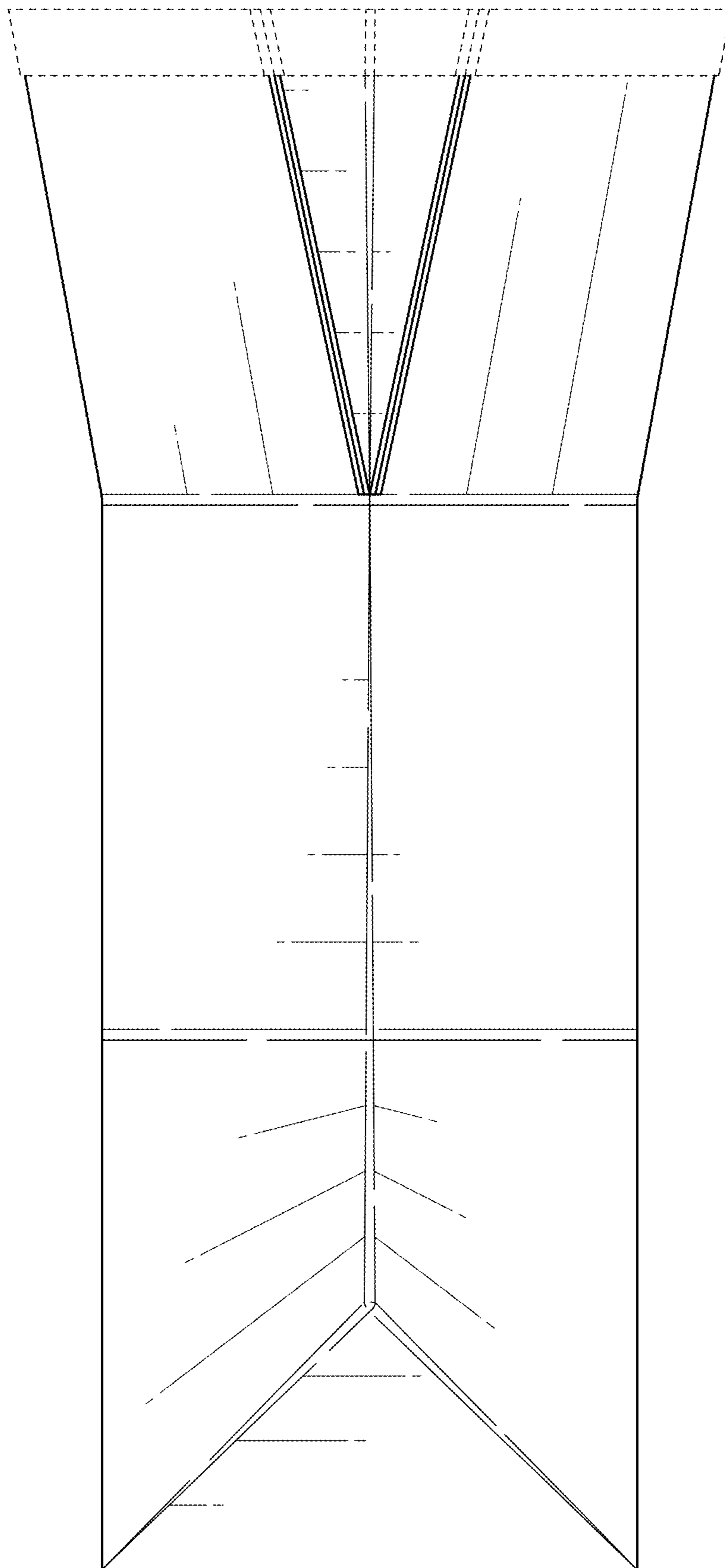

FIG. 4

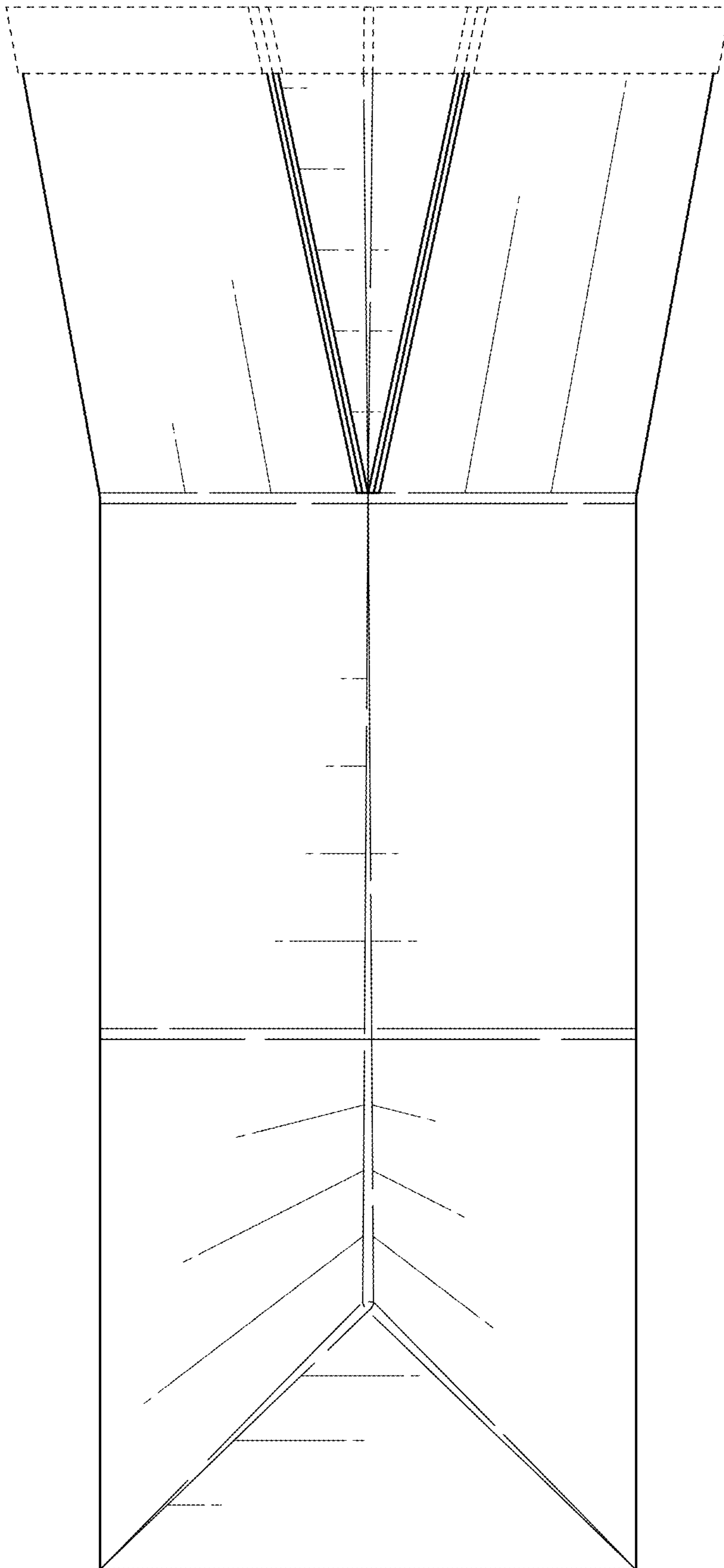

FIG. 5

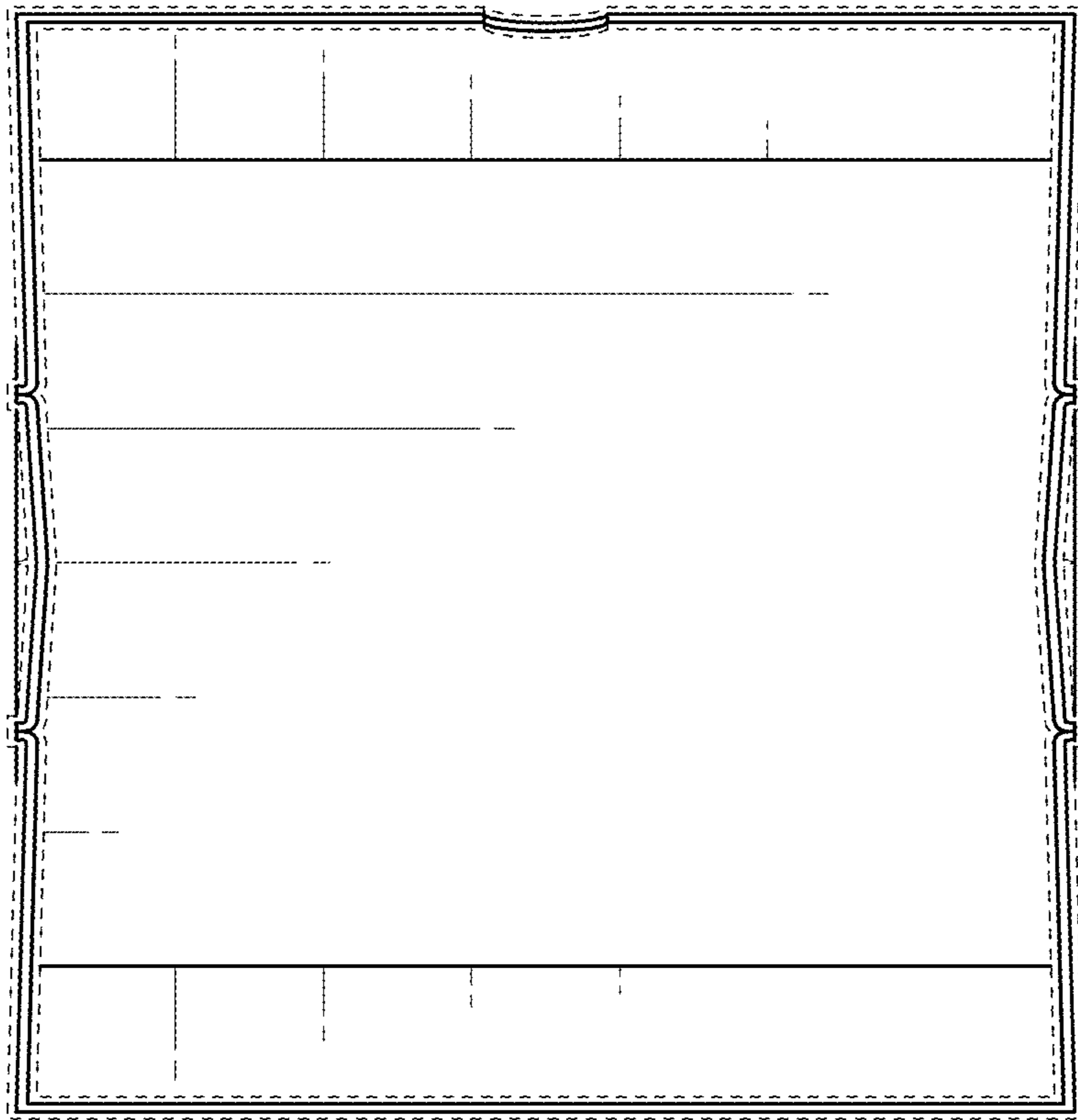

FIG. 6

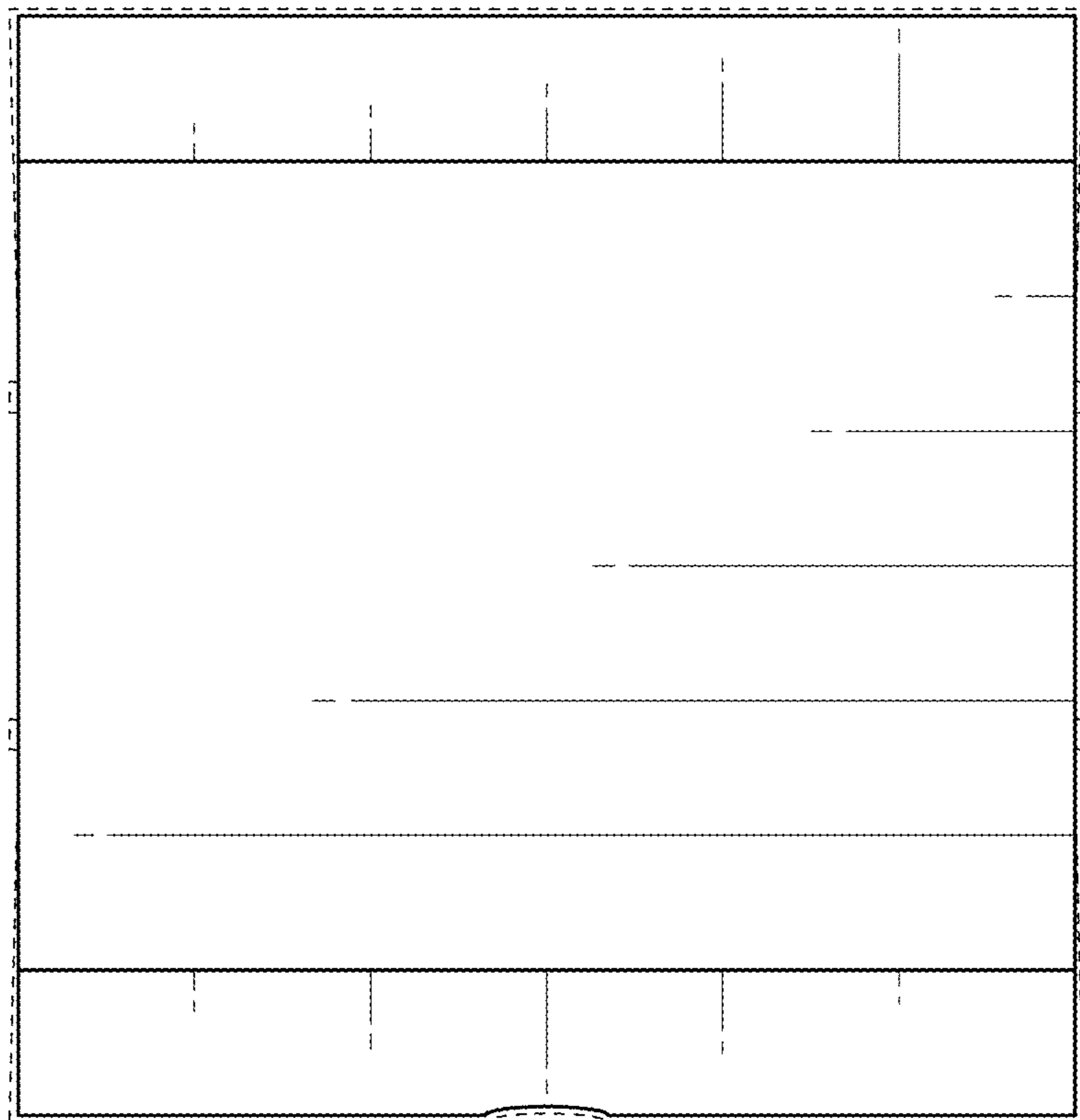

FIG. 7