



US00D953835S

(12) **United States Design Patent** (10) **Patent No.:** **US D953,835 S**
Lien (45) **Date of Patent:** **** Jun. 7, 2022**

(54) **BUCKET CARRIER**

(71) Applicant: **Doug Edward Lien**, Blaine, MN (US)

(72) Inventor: **Doug Edward Lien**, Blaine, MN (US)

(**) Term: **15 Years**

(21) Appl. No.: **29/737,802**

(22) Filed: **Jun. 11, 2020**

(51) **LOC (13) Cl.** **08-05**

(52) **U.S. Cl.**
USPC **D8/71**

(58) **Field of Classification Search**
USPC D8/14, 70-71, 373, 499; D30/133
(Continued)

(56) **References Cited**

U.S. PATENT DOCUMENTS

2,968,462 A * 1/1961 Jones D06F 95/002
248/312.1
D313,169 S * 12/1990 Scott D8/373
(Continued)

OTHER PUBLICATIONS

“Trash Bucket Holder”, Dec. 20, 2013, FabWorksOEM.com, site visited Mar. 8, 2022: <http://www.fabworksoem.net/ztm-tbh.php> (Year: 2013).*

(Continued)

Primary Examiner — Jack Reickel

Assistant Examiner — Michael A Kervin

(74) *Attorney, Agent, or Firm* — Michael A. Mochinski

(57) **CLAIM**

I claim the ornamental design for a bucket carrier, as shown and described.

DESCRIPTION

FIG. 1 is a front perspective view of a bucket carrier showing my new design;

FIG. 2 is a front elevational view thereof;
FIG. 3 is a rear elevational view thereof;
FIG. 4 is a right side elevational thereof, the left side elevational view being a mirror image thereof;
FIG. 5 is a top plan view thereof;
FIG. 6 is a bottom plan view thereof;
FIG. 7 is a cross sectional view thereof taken along line 7-7 of FIG. 4;
FIG. 8 is a rear perspective view thereof shown supporting and carrying a bucket;
FIG. 9 is a front perspective view of a bucket carrier showing a second embodiment of my new design;
FIG. 10 is a front elevational view thereof;
FIG. 11 is a rear elevational view thereof;
FIG. 12 is a right side elevational thereof, the left side elevational view being a mirror image thereof;
FIG. 13 is a top plan view thereof;
FIG. 14 is a bottom plan view thereof;
FIG. 15 is a cross sectional view thereof taken along line 15-15 of FIG. 12;
FIG. 16 is a front perspective view of a bucket carrier showing a third embodiment of my new design;
FIG. 17 is a front elevational view thereof;
FIG. 18 is a rear elevational view thereof;
FIG. 19 is a right side elevational thereof, the left side elevational view being a mirror image thereof;
FIG. 20 is a top plan view thereof;
FIG. 21 is a bottom plan view thereof;
FIG. 22 is a cross sectional view thereof taken along line 22-22 of FIG. 19;
FIG. 23 is a front perspective view of a bucket carrier showing a fourth embodiment of my new design;
FIG. 24 is a front elevational view thereof;
FIG. 25 is a rear elevational view thereof;
FIG. 26 is a right side elevational thereof, the left side elevational view being a mirror image thereof;
FIG. 27 is a top plan view thereof;
FIG. 28 is a bottom plan view thereof;
FIG. 29 is a cross sectional view thereof taken along line 29-29 of FIG. 26;
FIG. 30 is a front perspective view of a bucket carrier showing a fifth embodiment of my new design;
FIG. 31 is a front elevational view thereof;

(Continued)

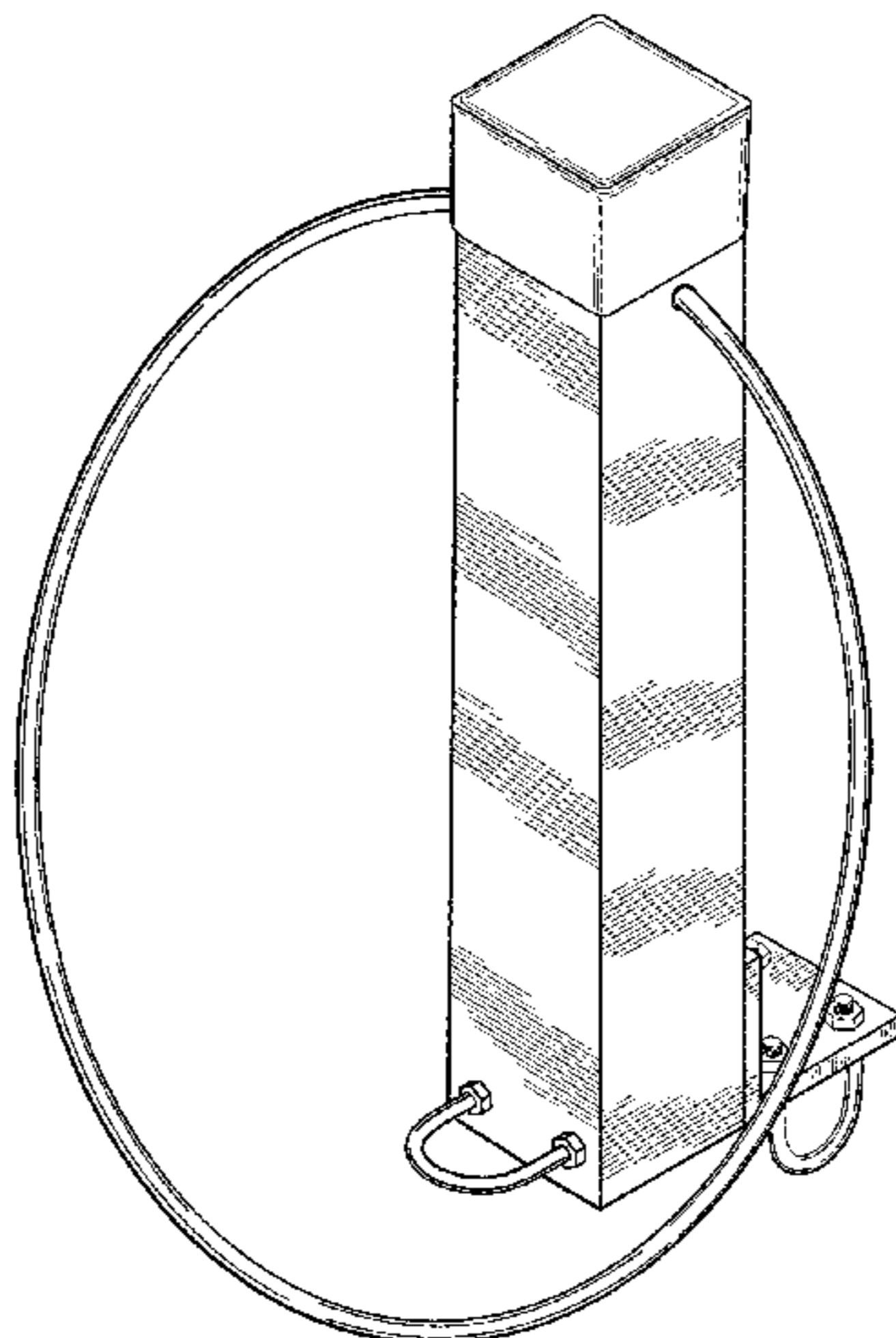

FIG. 32 is a rear elevational view thereof;
 FIG. 33 is a right side elevational thereof, the left side elevational view being a mirror image thereof;
 FIG. 34 is a top plan view thereof;
 FIG. 35 is a bottom plan view thereof;
 FIG. 36 is a cross sectional view thereof taken along line 36-36 of FIG. 33;
 FIG. 37 is a front perspective view of a bucket carrier showing a sixth embodiment of my new design;
 FIG. 38 is a front elevational view thereof;
 FIG. 39 is a rear elevational view thereof;
 FIG. 40 is a right side elevational thereof, the left side elevational view being a mirror image thereof;
 FIG. 41 is a top plan view thereof;
 FIG. 42 is a bottom plan view thereof;
 FIG. 43 is a cross sectional view thereof taken along line 43-43 of FIG. 40;
 FIG. 44 is a front perspective view of a bucket carrier showing a seventh embodiment of my new design;
 FIG. 45 is a front elevational view thereof;
 FIG. 46 is a rear elevational view thereof;
 FIG. 47 is a right side elevational thereof, the left side elevational view being a mirror image thereof;
 FIG. 48 is a top plan view thereof;
 FIG. 49 is a bottom plan view thereof;
 FIG. 50 is a cross sectional view thereof taken along line 50-50 of FIG. 47;
 FIG. 51 is a front perspective view of a bucket carrier showing an eighth embodiment of my new design;
 FIG. 52 is a front elevational view thereof;
 FIG. 53 is a rear elevational view thereof;
 FIG. 54 is a right side elevational thereof, the left side elevational view being a mirror image thereof;
 FIG. 55 is a top plan view thereof;
 FIG. 56 is a bottom plan view thereof; and,
 FIG. 57 is a cross sectional view thereof taken along line 57-57 of FIG. 54.

The broken line showing of a bucket is for the purpose of illustrating environmental structure and forms no part of the claimed design.

1 Claim, 49 Drawing Sheets

(58) **Field of Classification Search**
 CPC . A01K 5/01; A47J 47/18; A47L 13/51; A47L 13/512; B60S 3/045; D06F 57/12
 See application file for complete search history.

(56) **References Cited**

U.S. PATENT DOCUMENTS

5,036,799	A *	8/1991	Jordan	A01K 5/01 248/311.2
5,163,648	A *	11/1992	Schneider	A01K 97/05 D34/6
D332,381	S *	1/1993	Rotellini, Jr.	D10/65
D343,266	S *	1/1994	Gromer	D32/54
D390,775	S *	2/1998	DePietro	D8/373
D392,487	S *	3/1998	Cambron	D6/566
D419,812	S *	2/2000	Robichaud	D6/566
D420,512	S *	2/2000	Martin	D8/71
6,231,019	B1 *	5/2001	Broste	A01K 5/01 248/312.1
D512,893	S *	12/2005	Cowan	D8/71
D621,243	S *	8/2010	Hill	D8/373
D650,610	S *	12/2011	Carr	D6/682.1
D798,993	S *	10/2017	Mittag	D8/373
D803,022	S *	11/2017	Daly	D8/71
D929,211	S *	8/2021	Jackson	D8/373
2021/0290030	A1 *	9/2021	Mikacich	D06F 57/12

OTHER PUBLICATIONS

“Buyers Products LT25 Water Cooler Trailer Rack”, Aug. 7, 2014, Amazon.ca, site visited Mar. 8, 2022: <https://www.amazon.ca/Buyers-LT25-Cooler-Landscape-Trailer/dp/B0000AX728> (Year: 2014).*

* cited by examiner

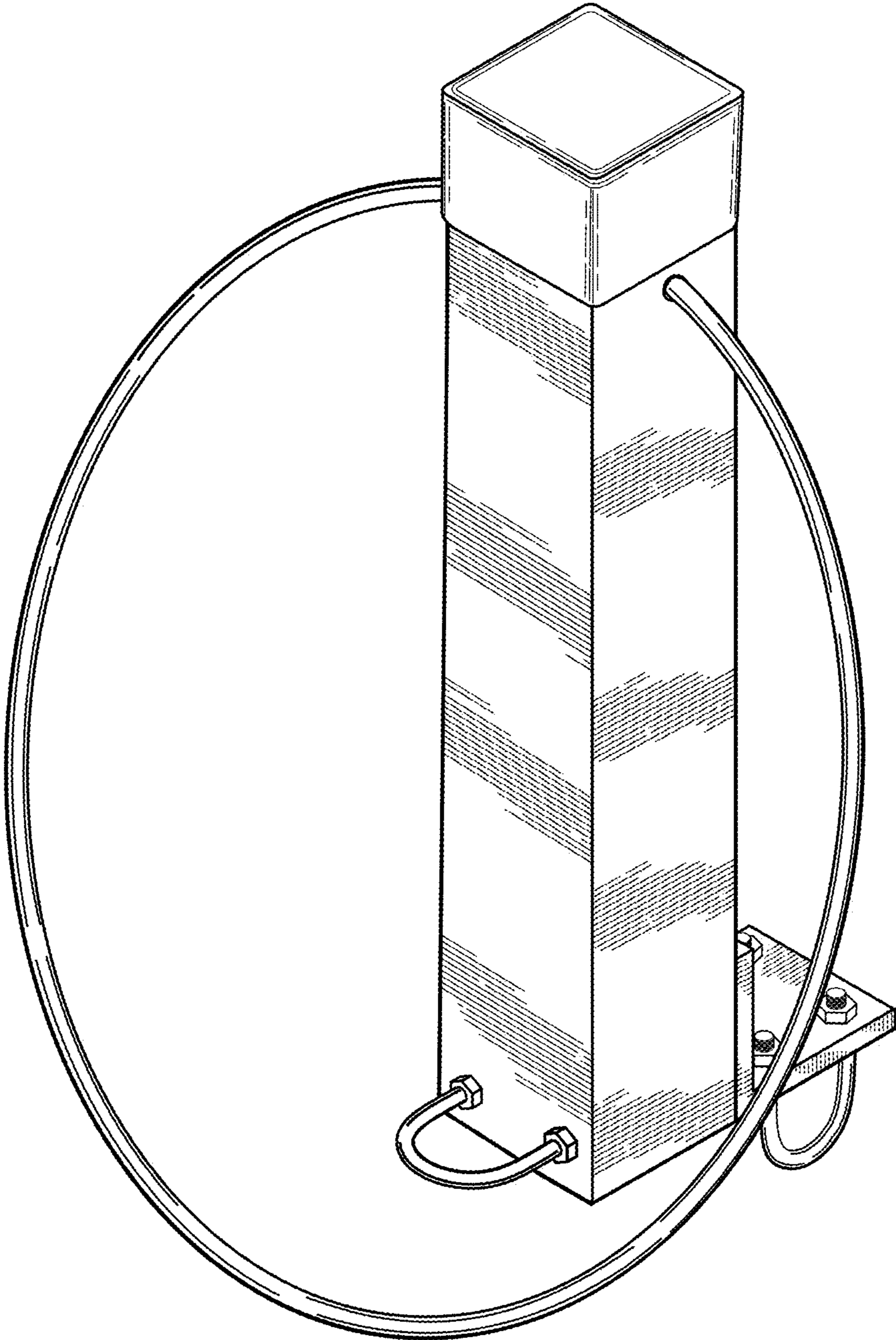

FIG. 1

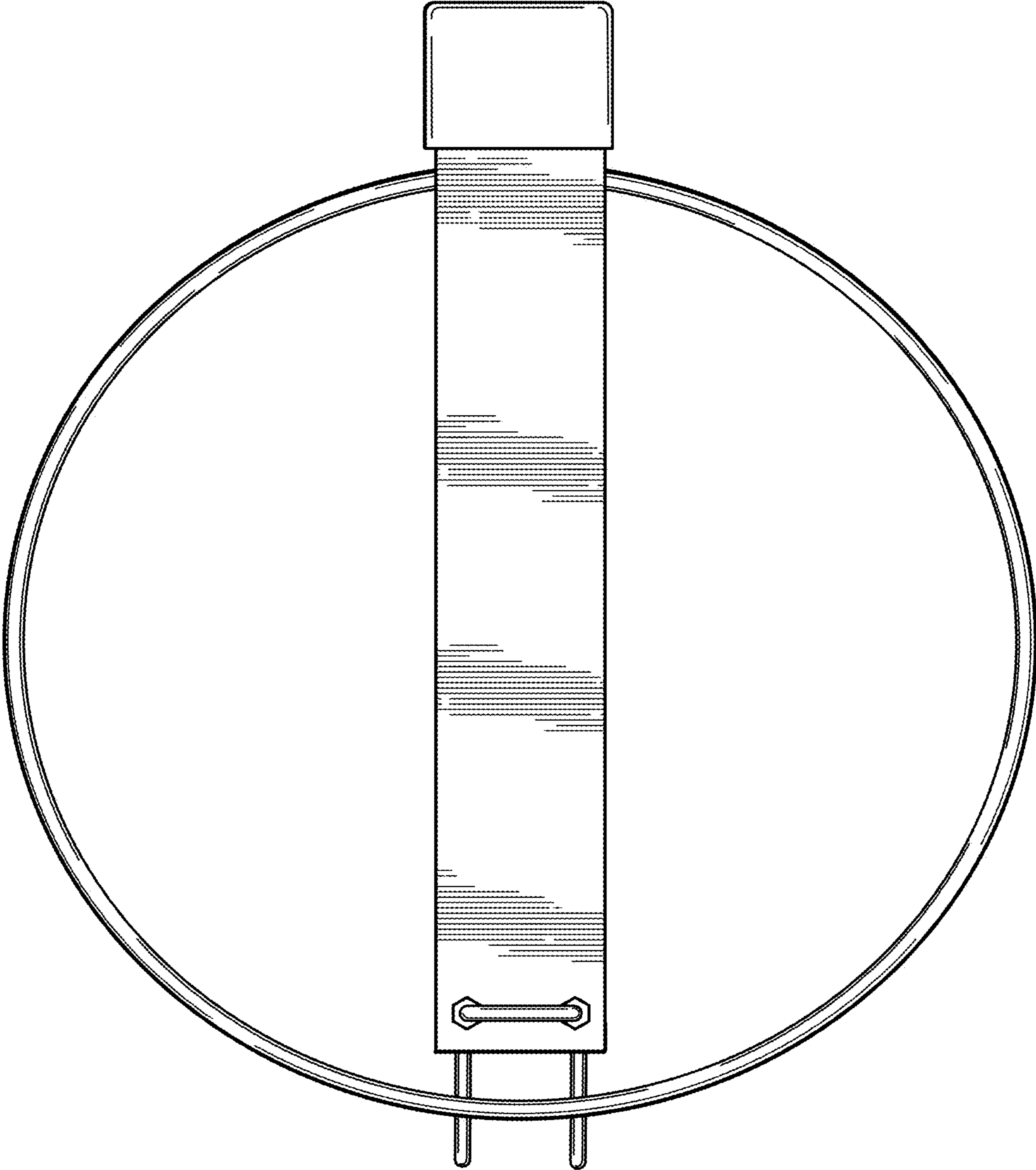

FIG. 2

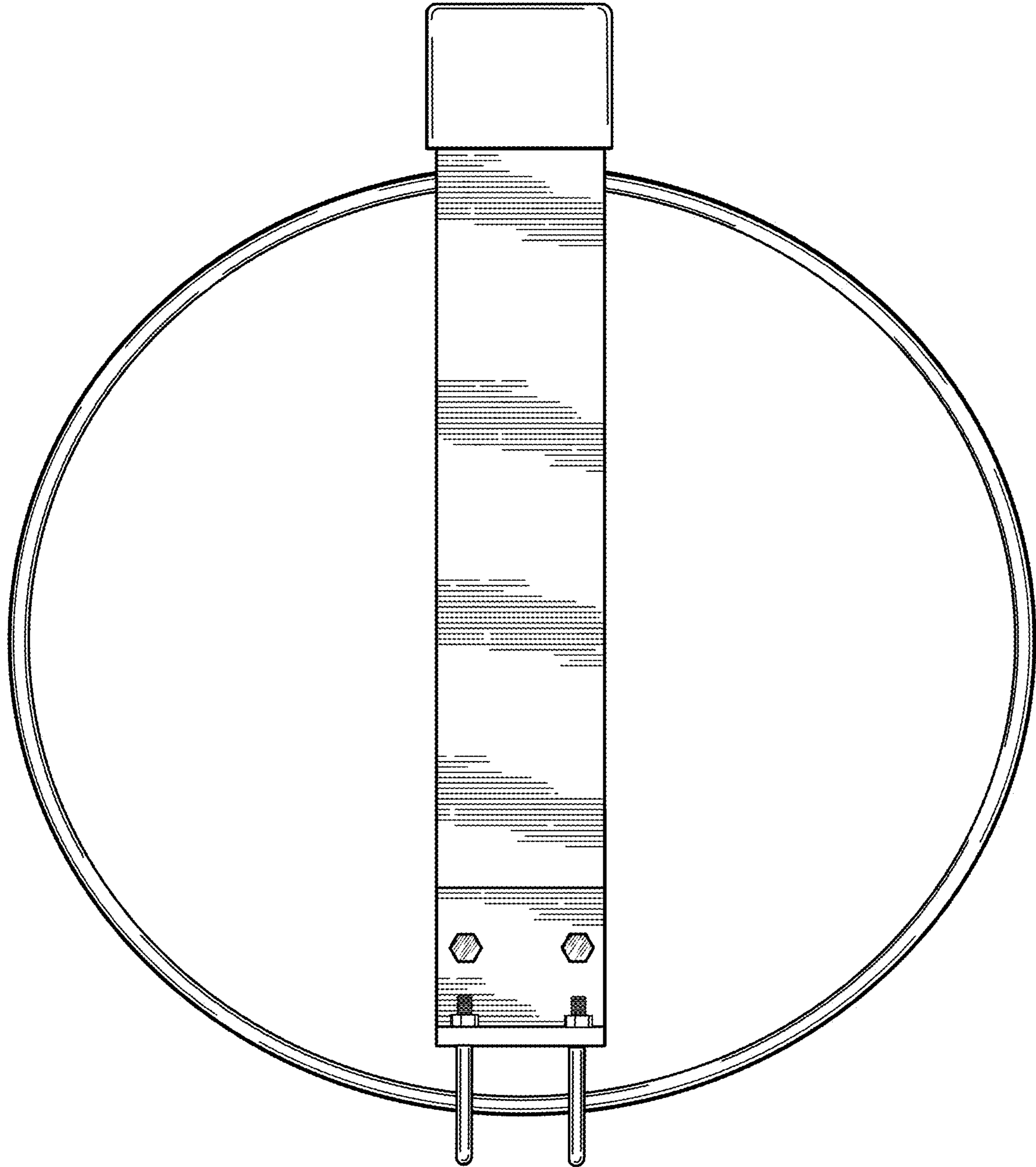

FIG. 3

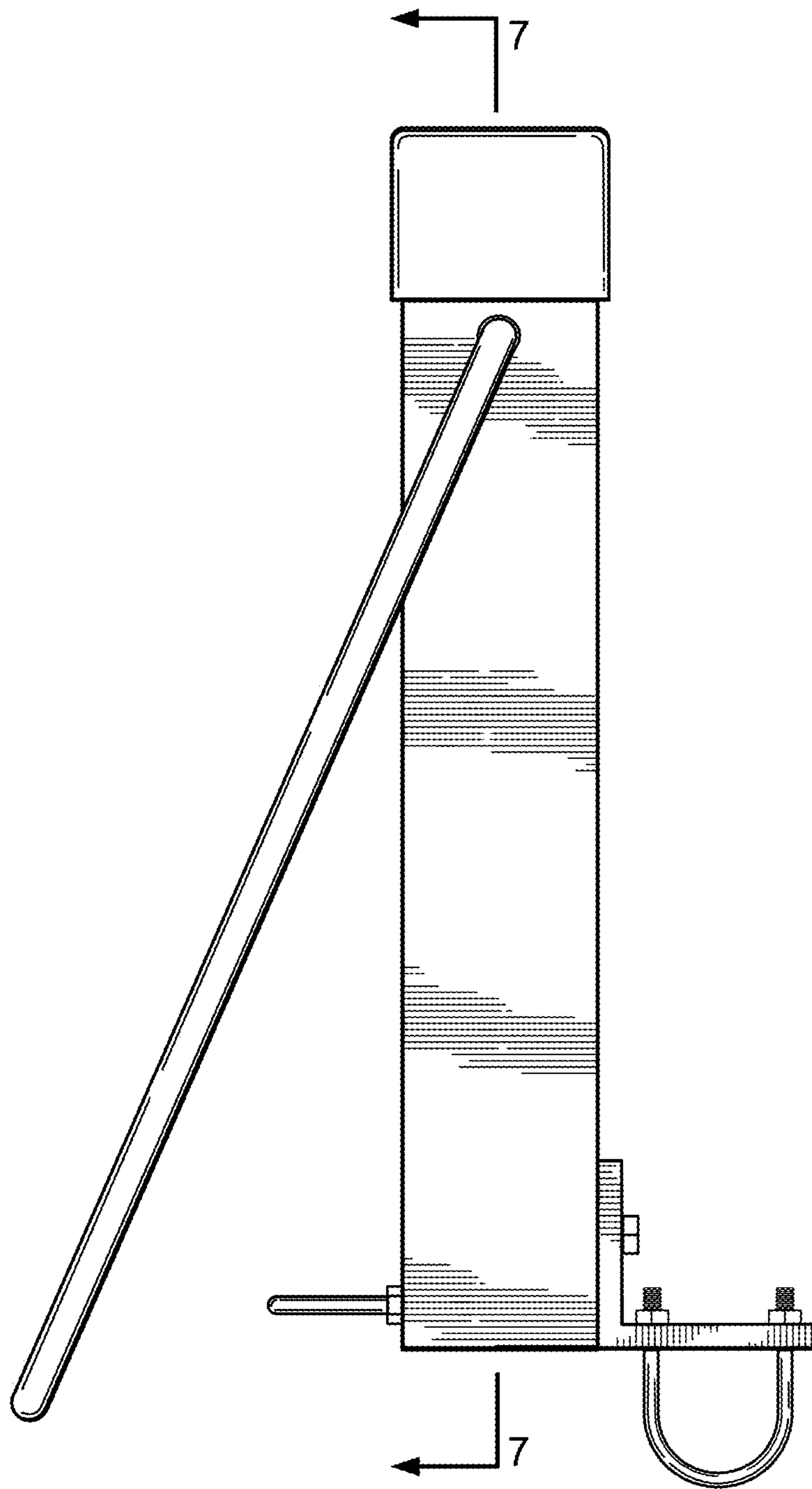

FIG. 4

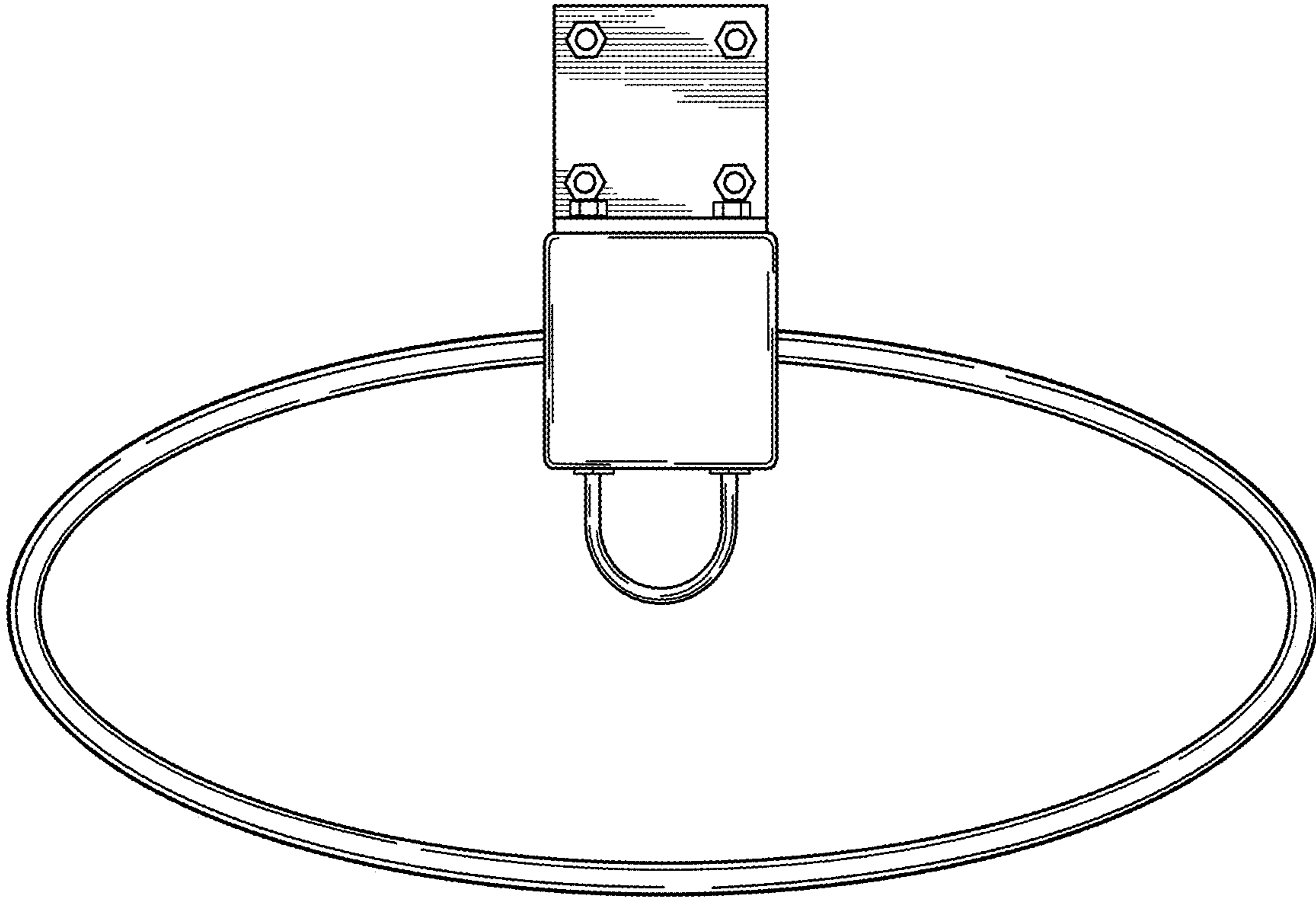

FIG. 5

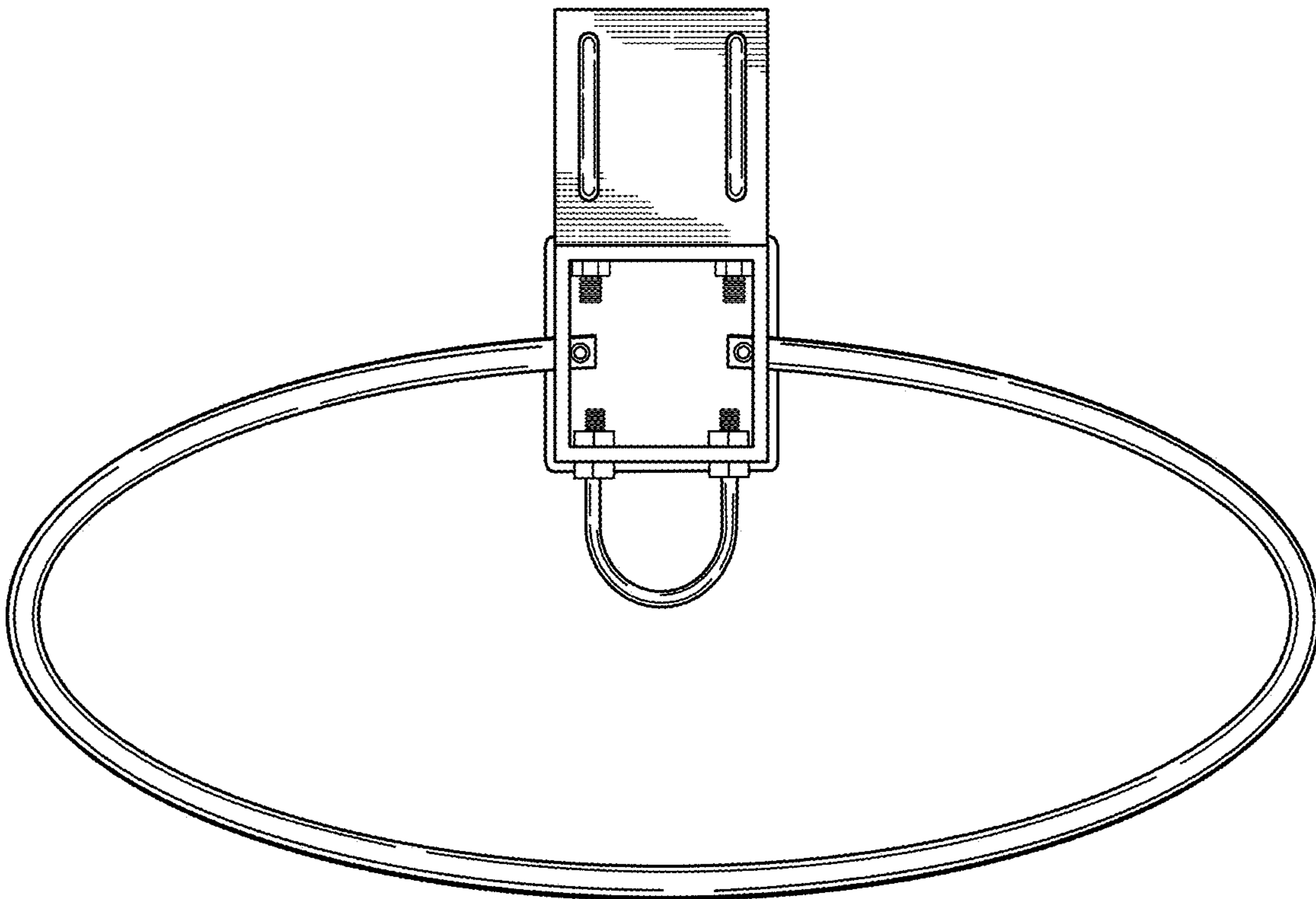

FIG. 6

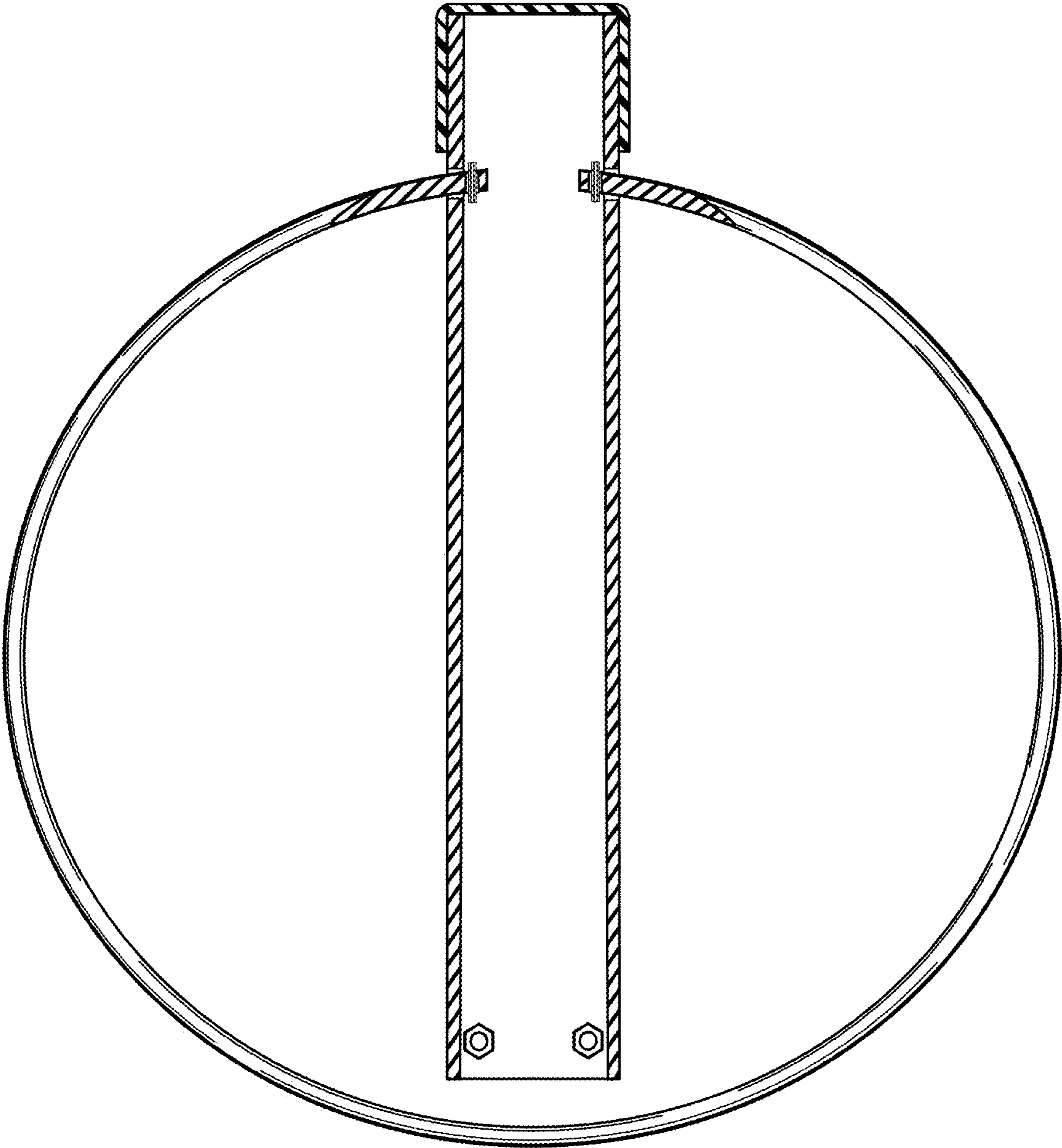

FIG. 7

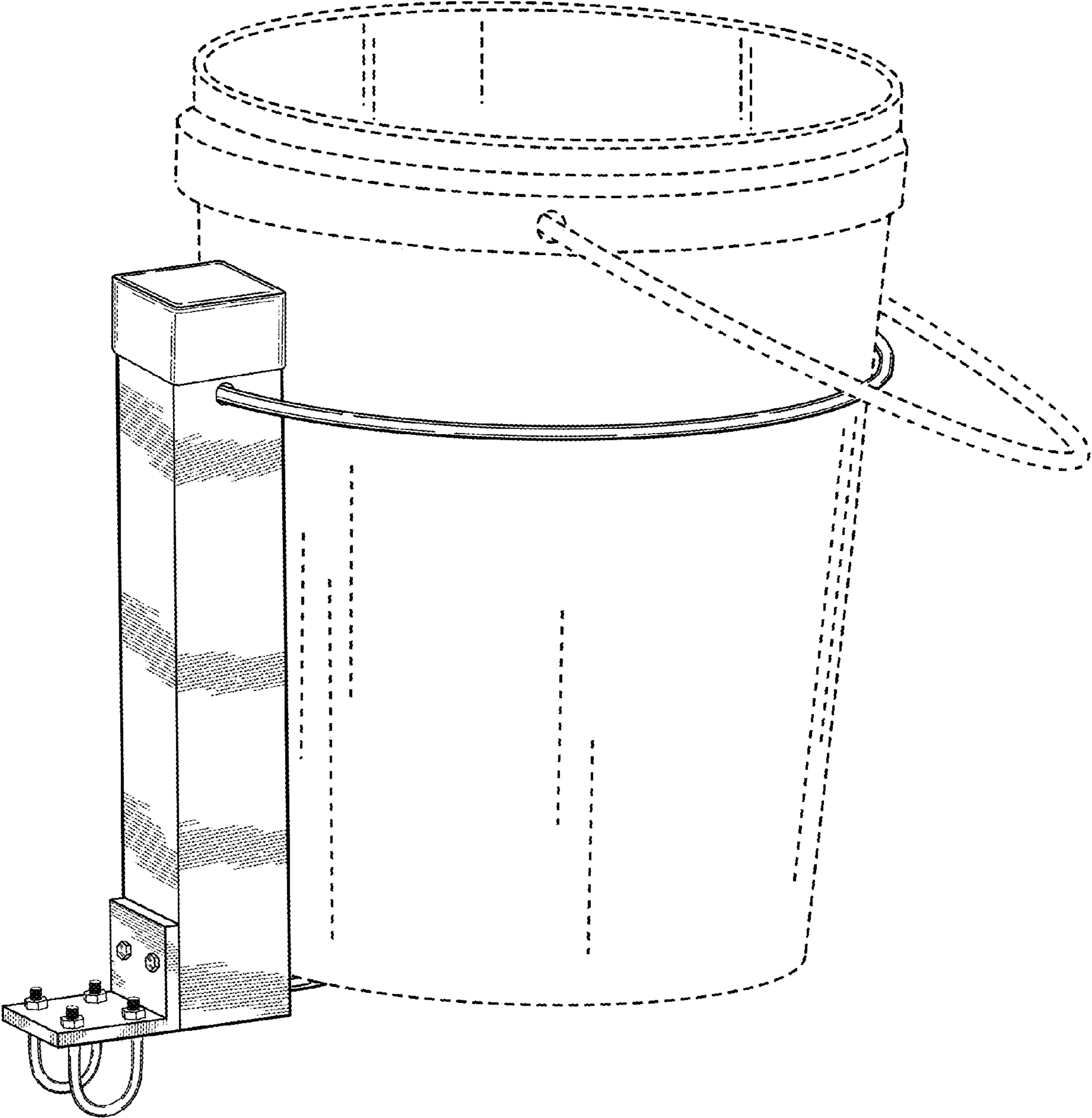

FIG. 8

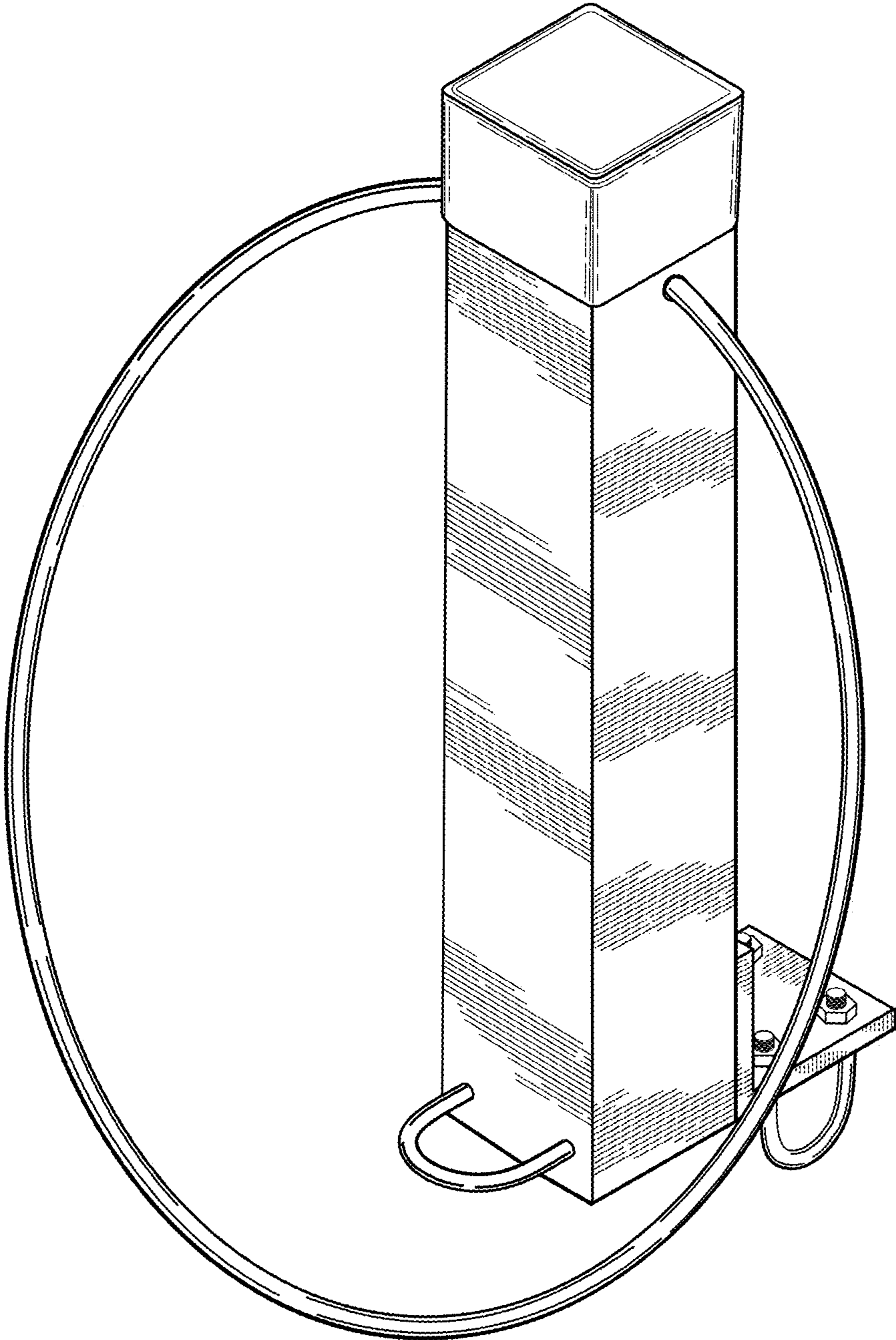

FIG. 9

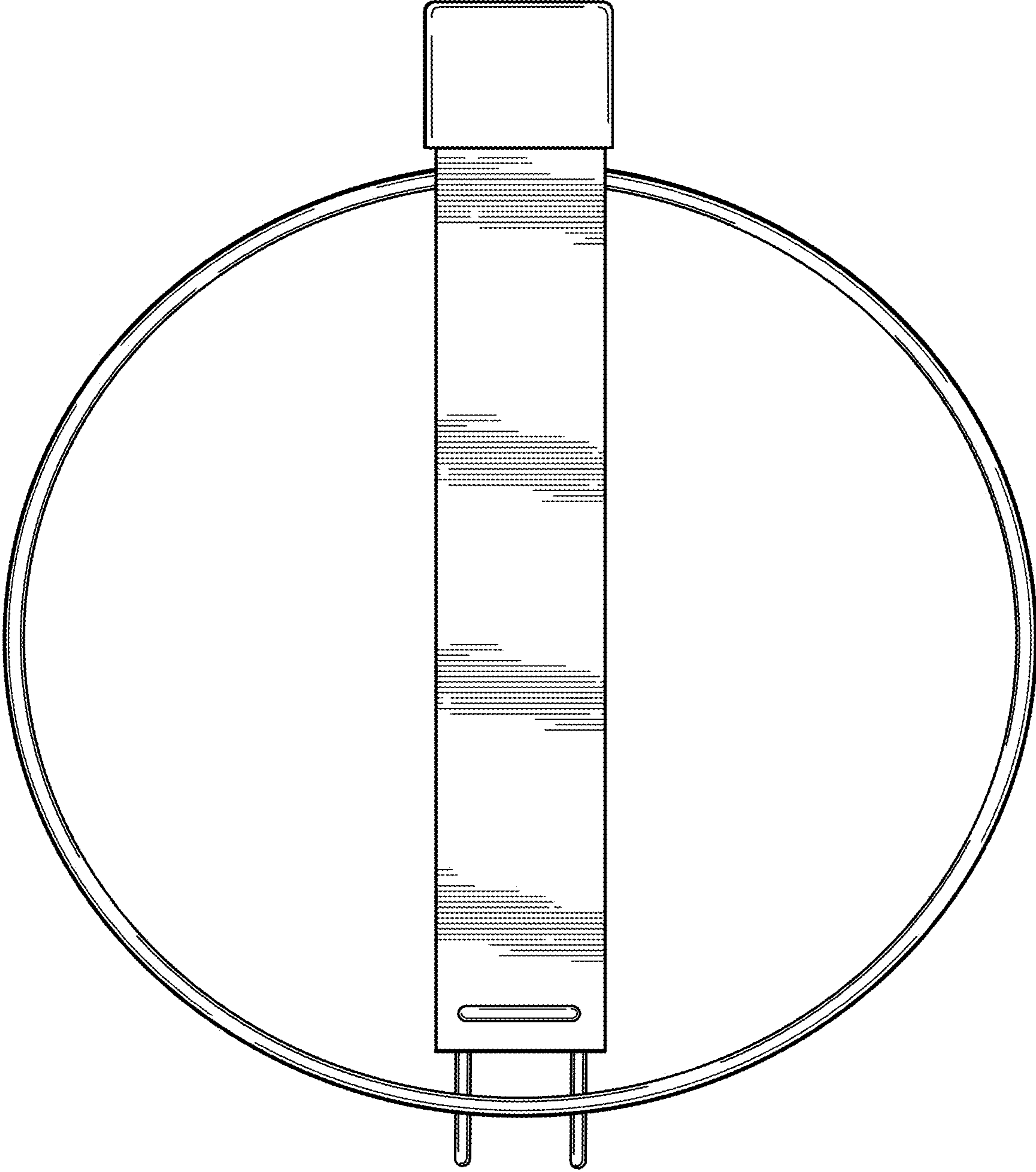

FIG. 10

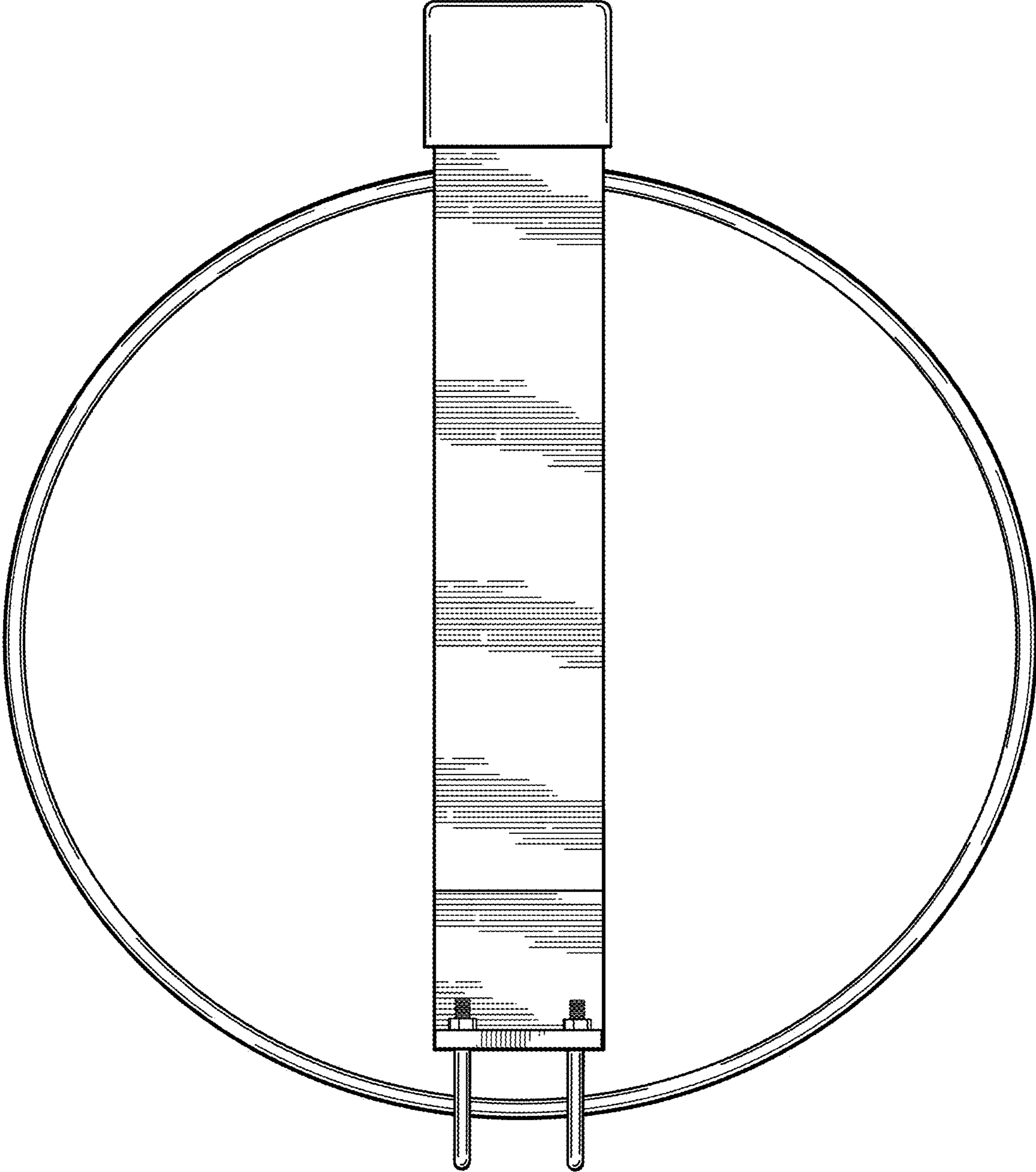

FIG. 11

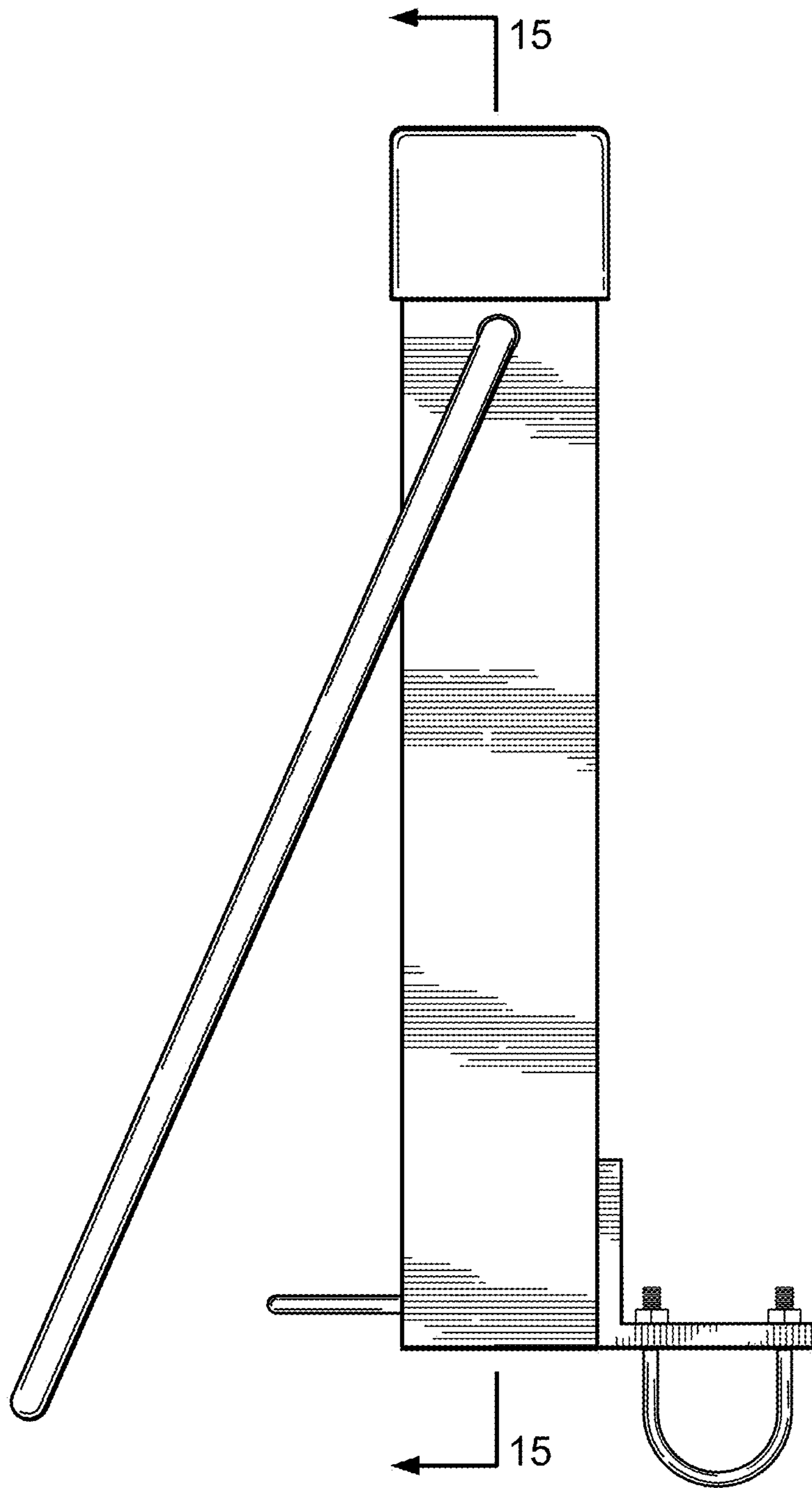

FIG. 12

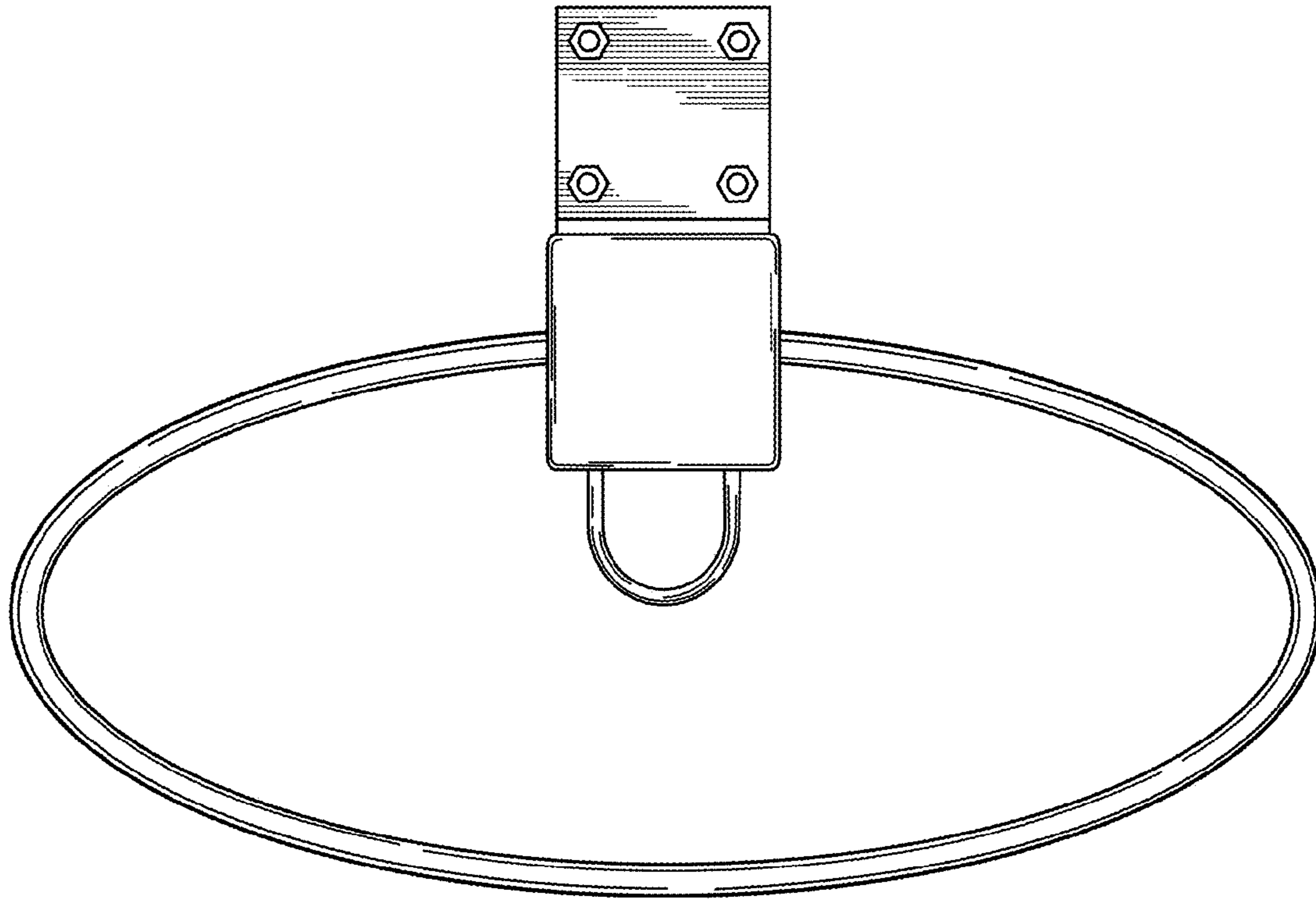

FIG. 13

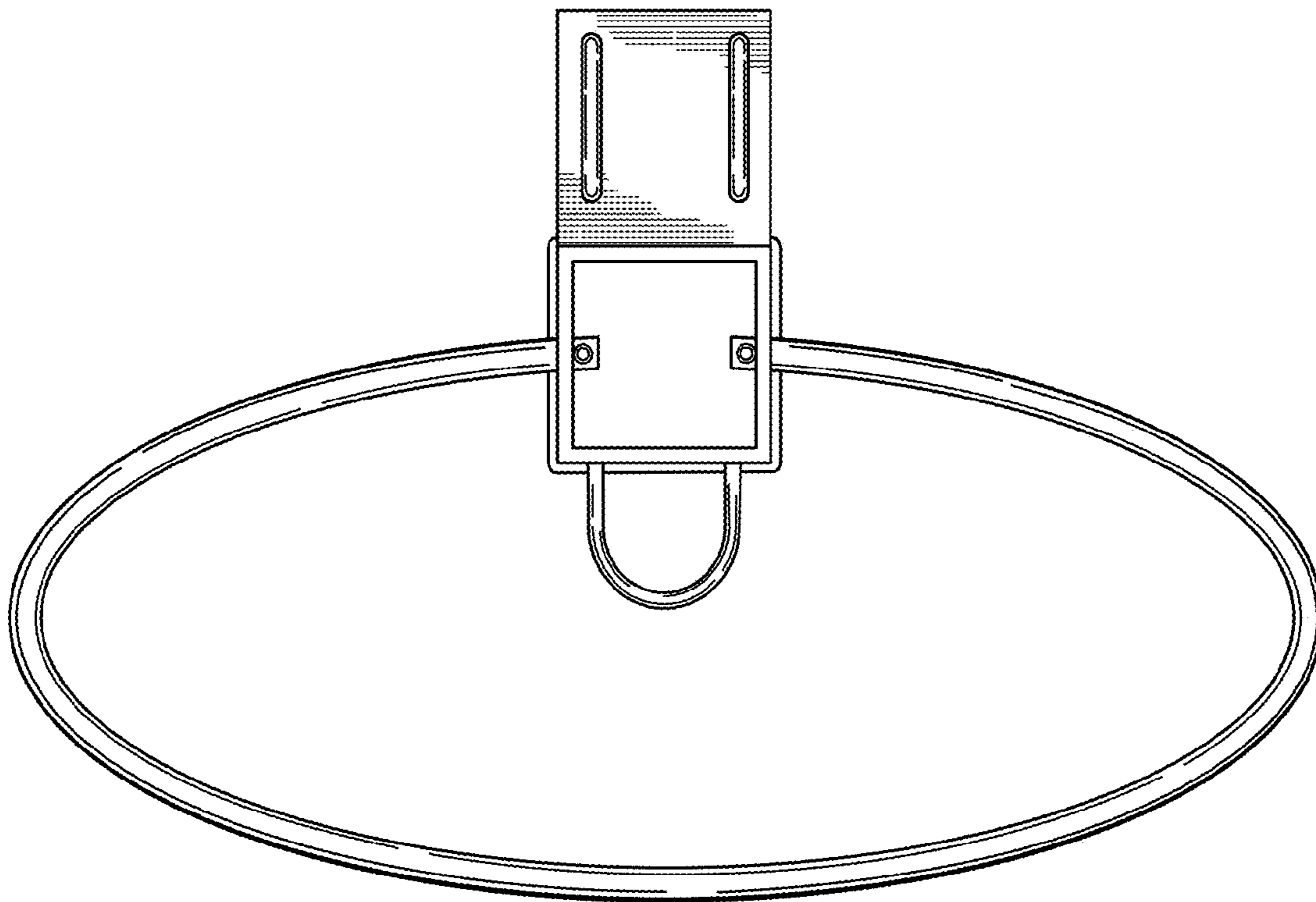

FIG. 14

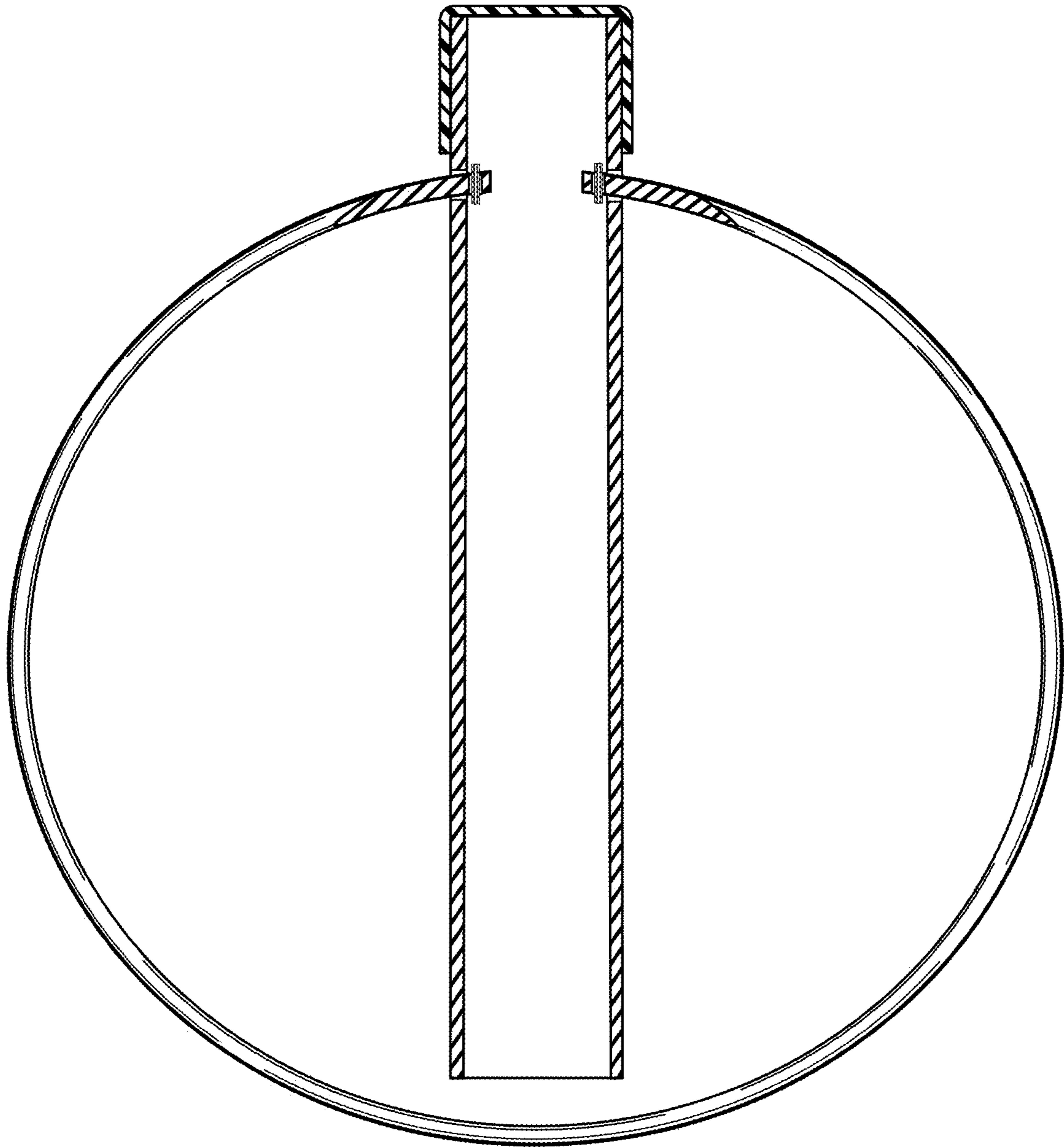

FIG. 15

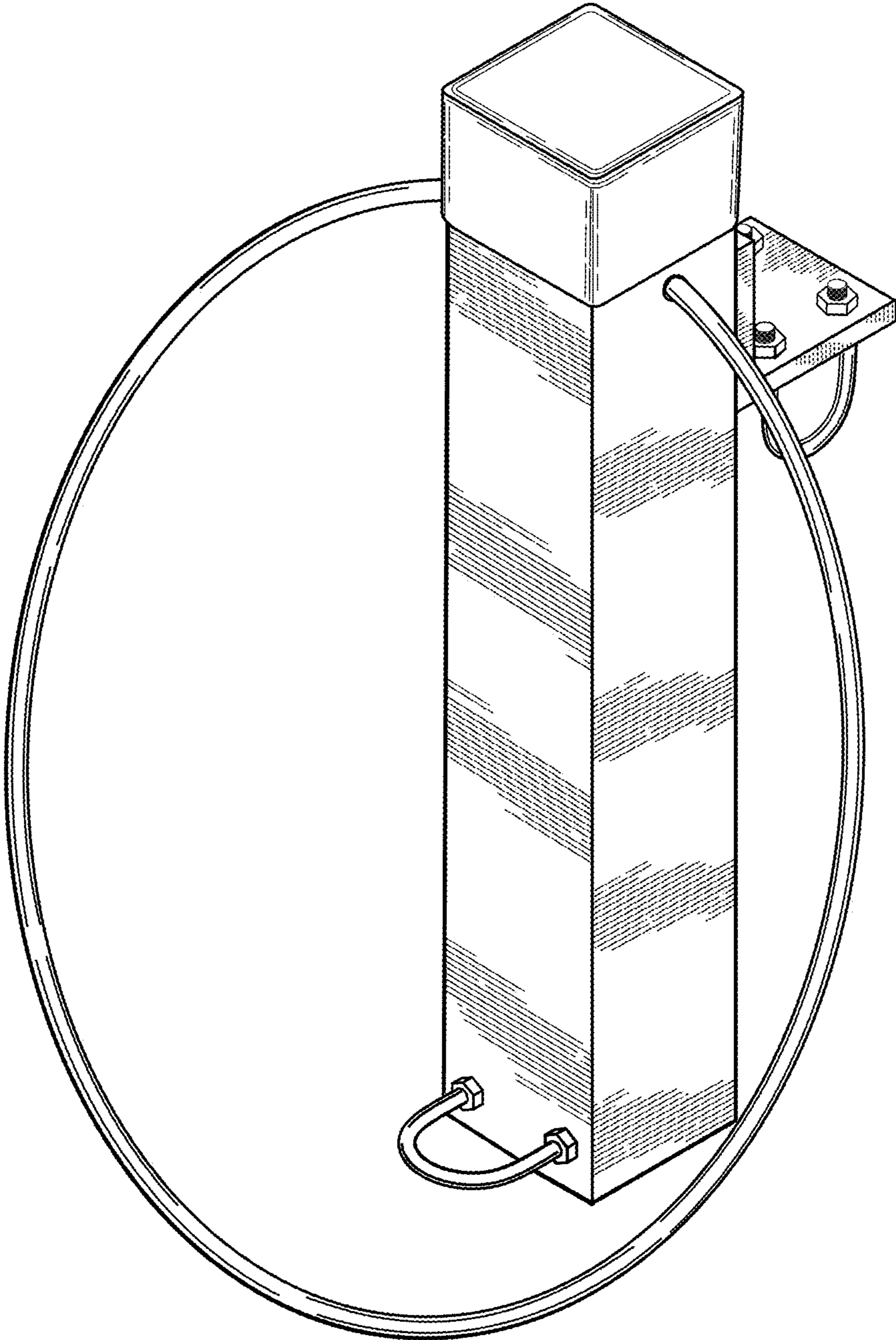

FIG. 16

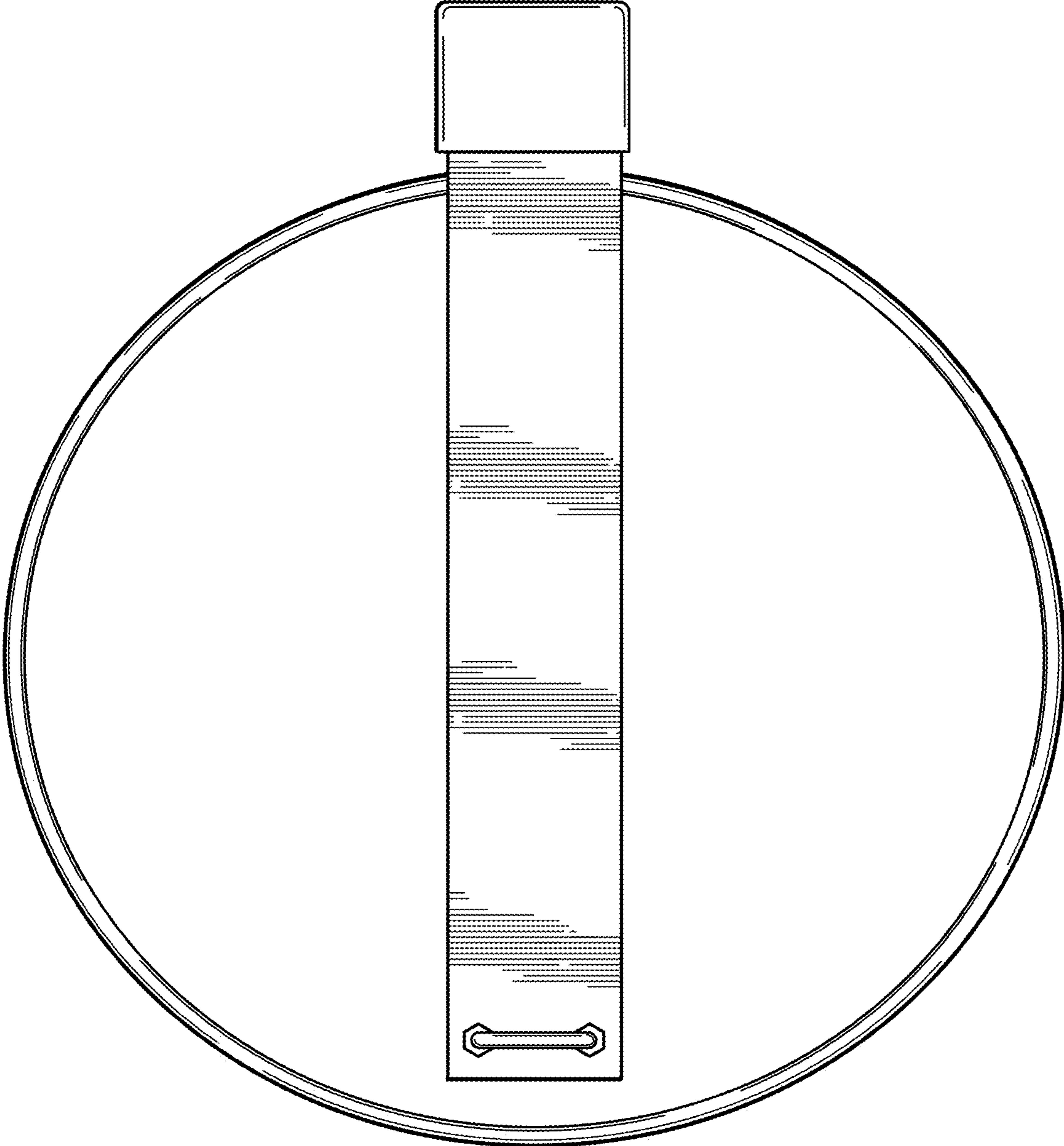

FIG. 17

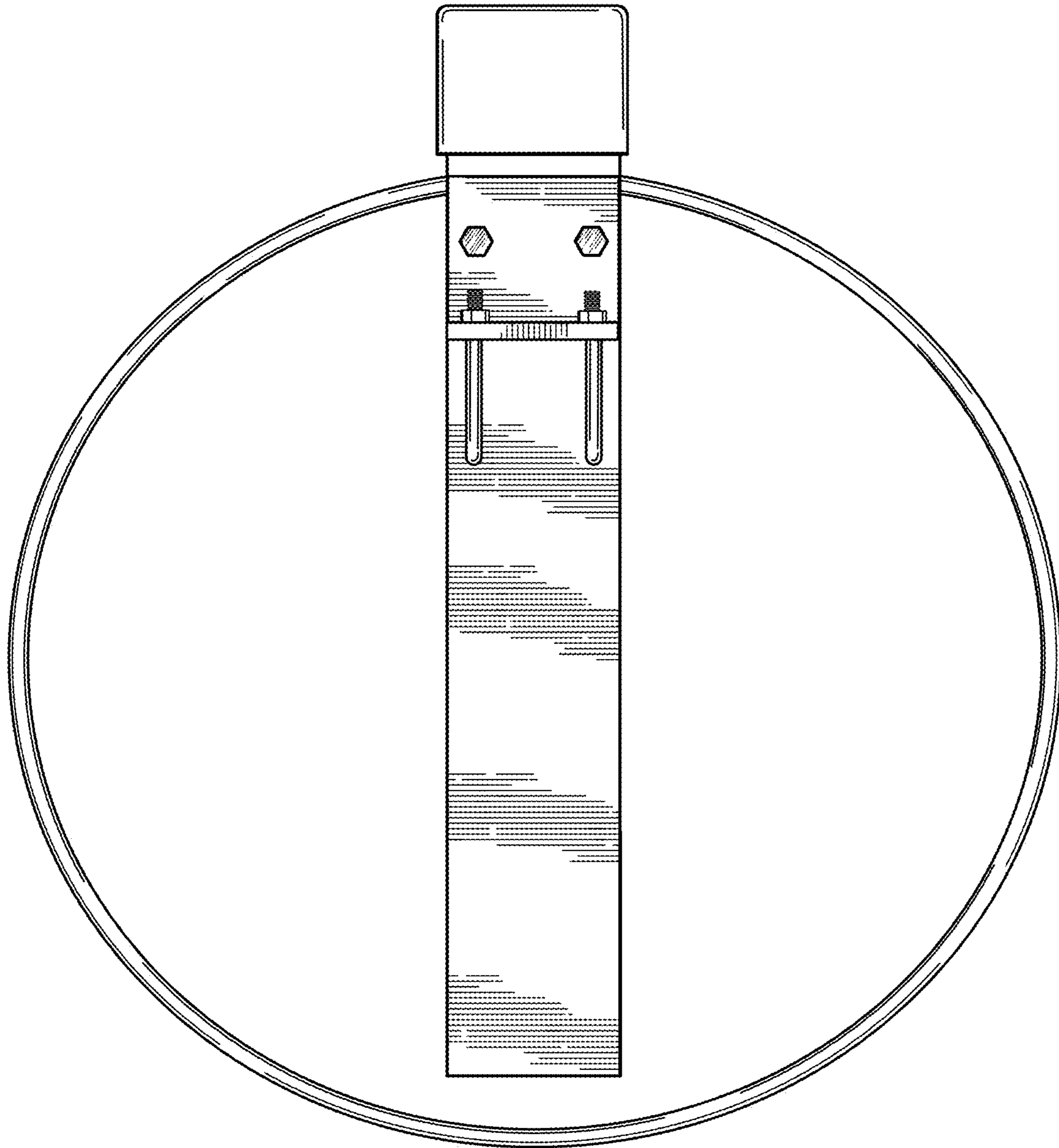

FIG. 18

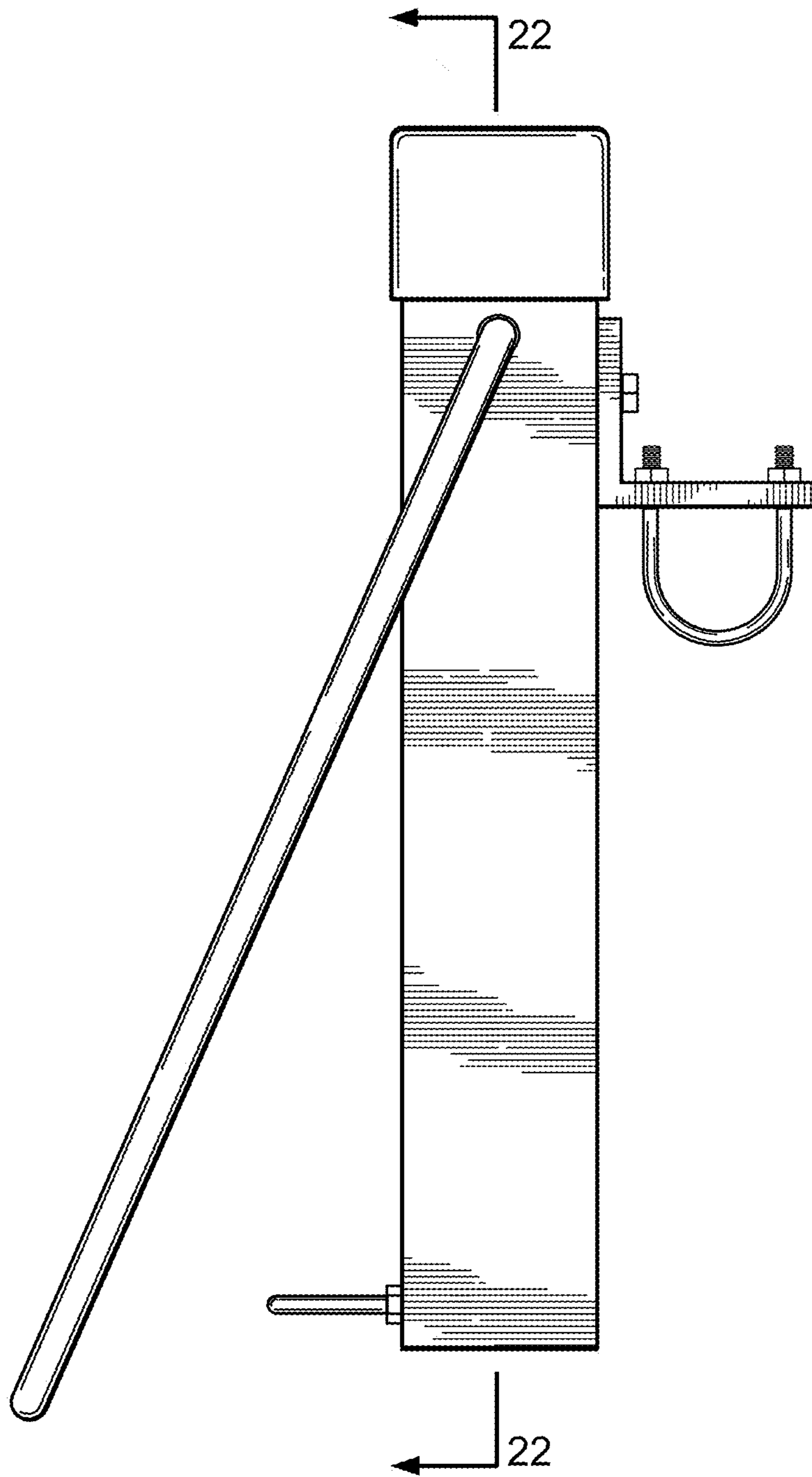

FIG. 19

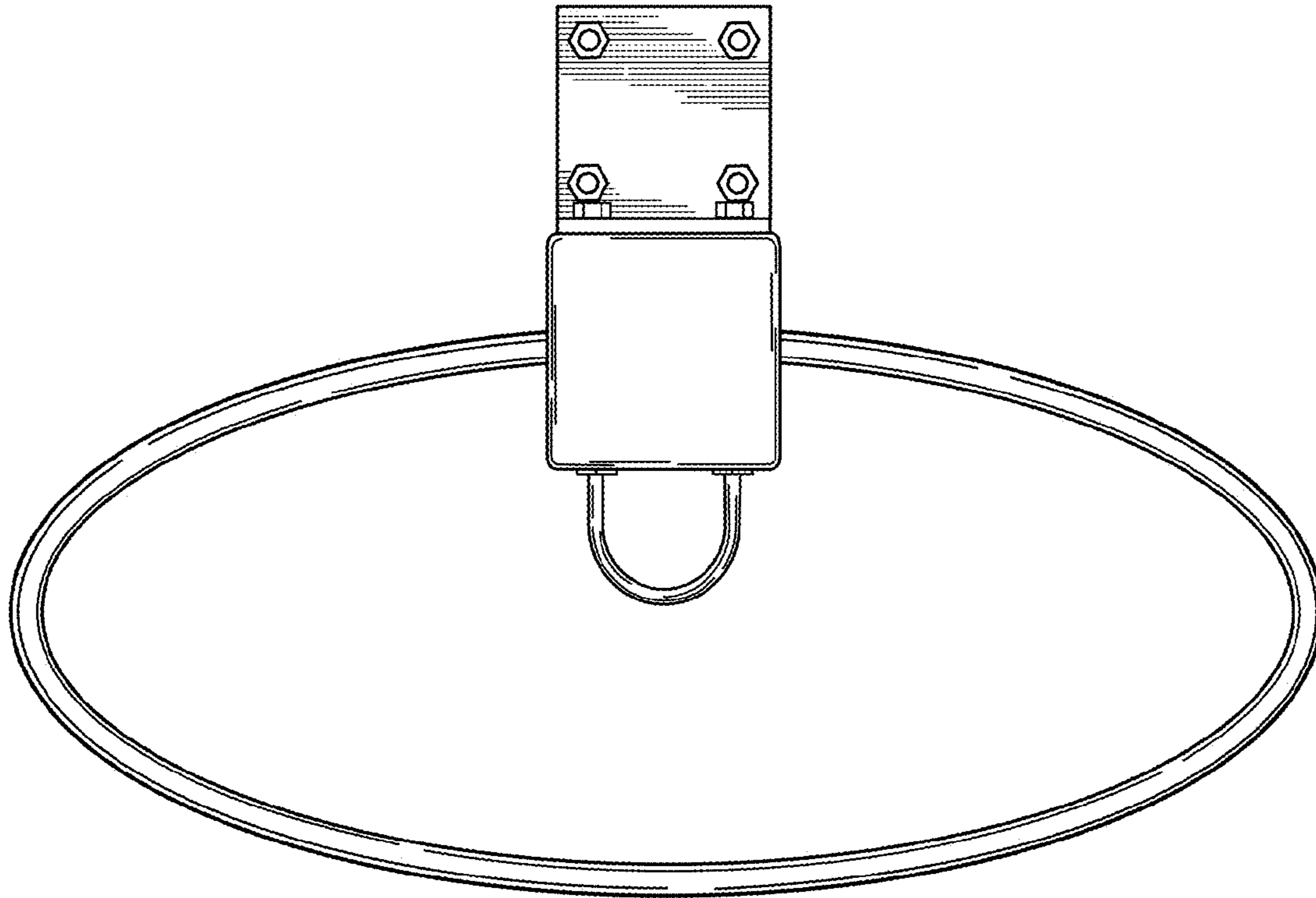

FIG. 20

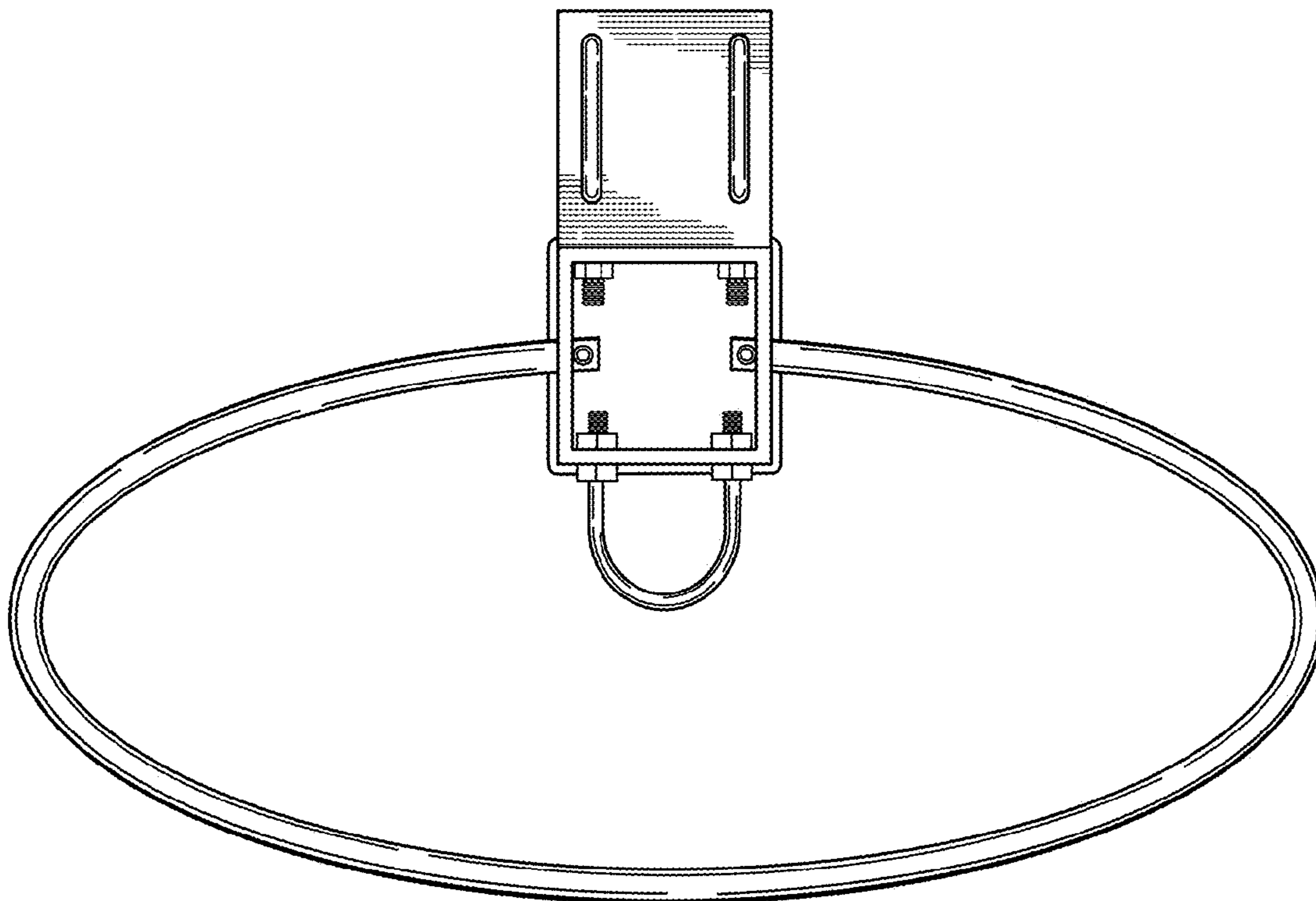

FIG. 21

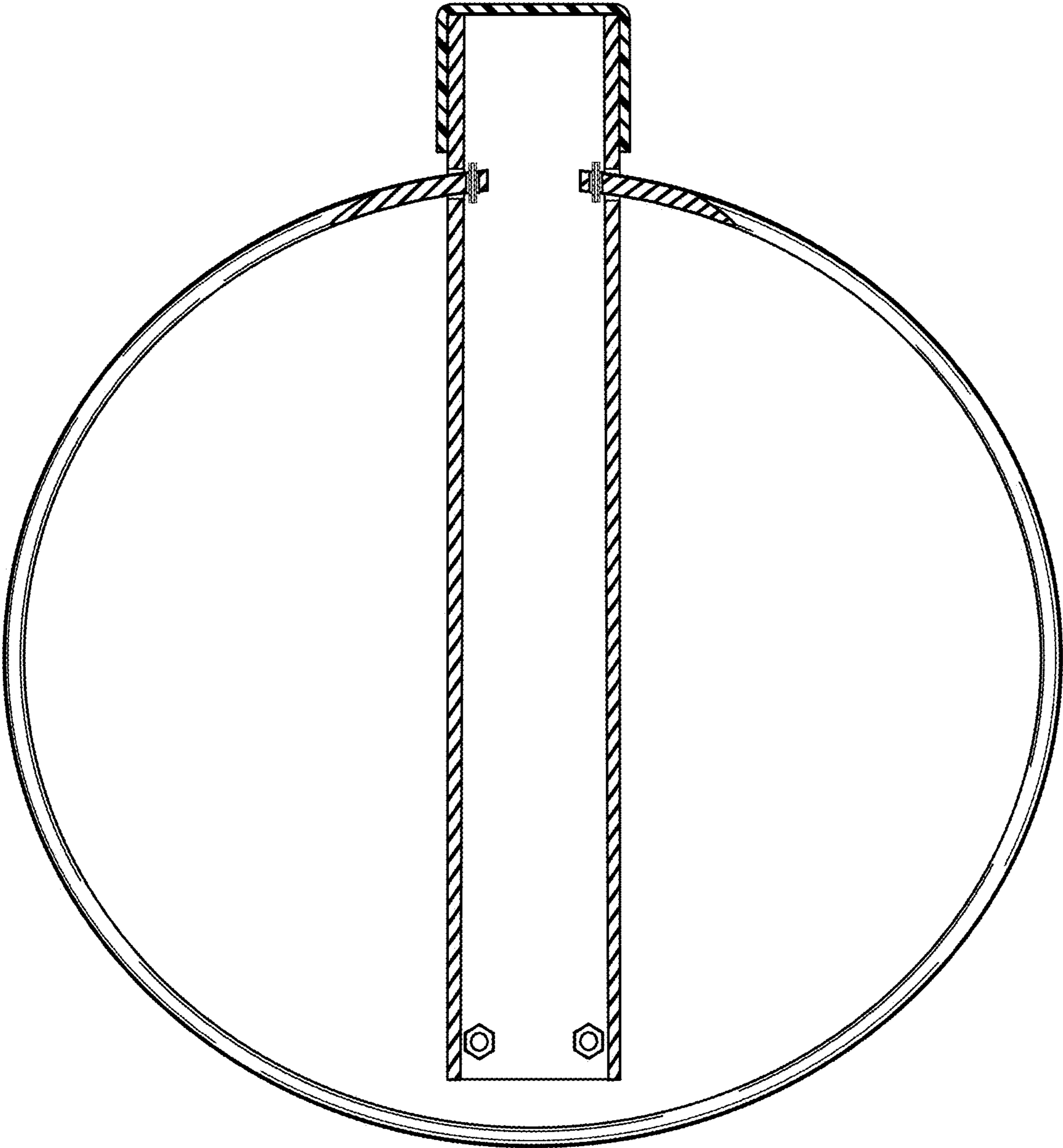

FIG. 22

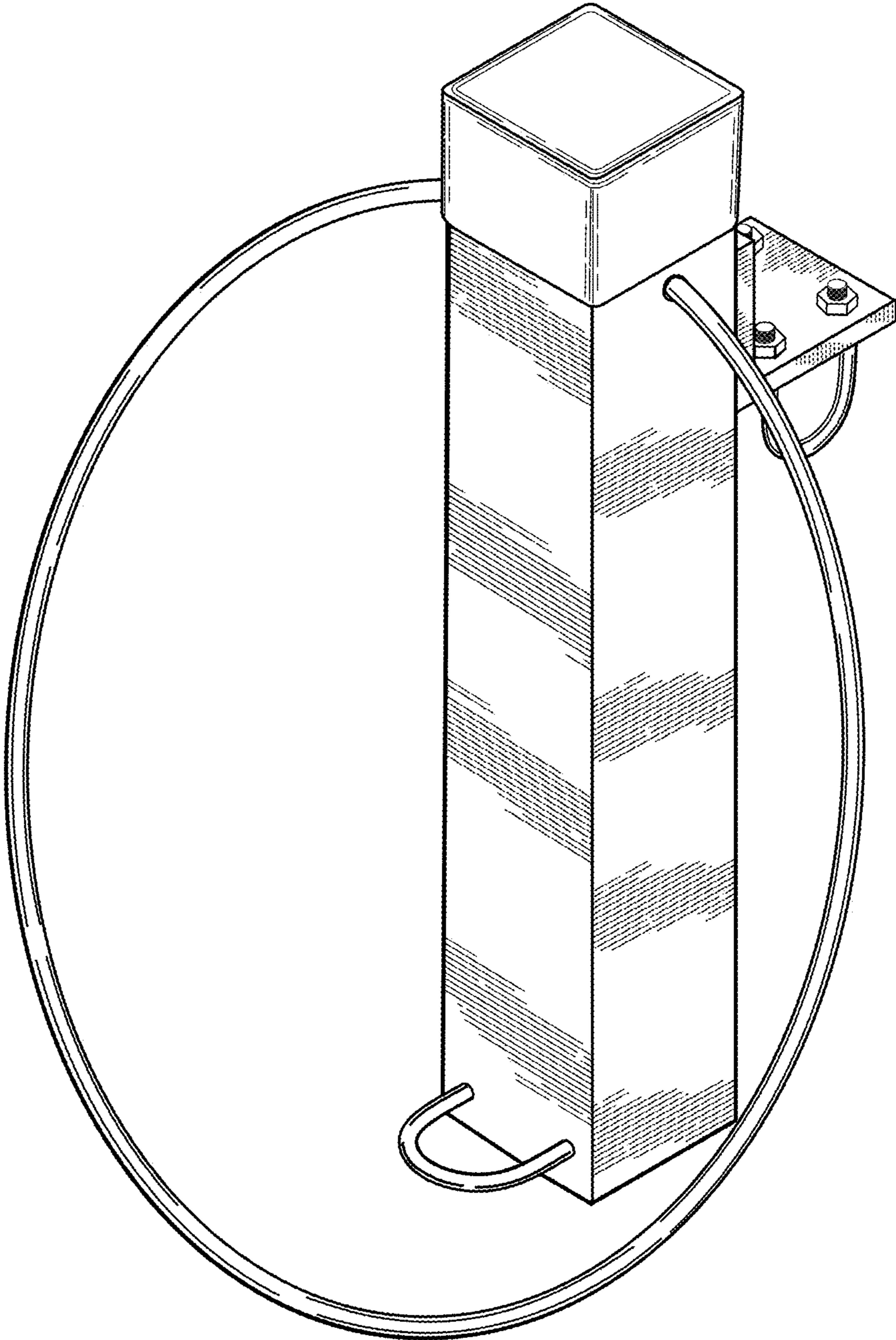

FIG. 23

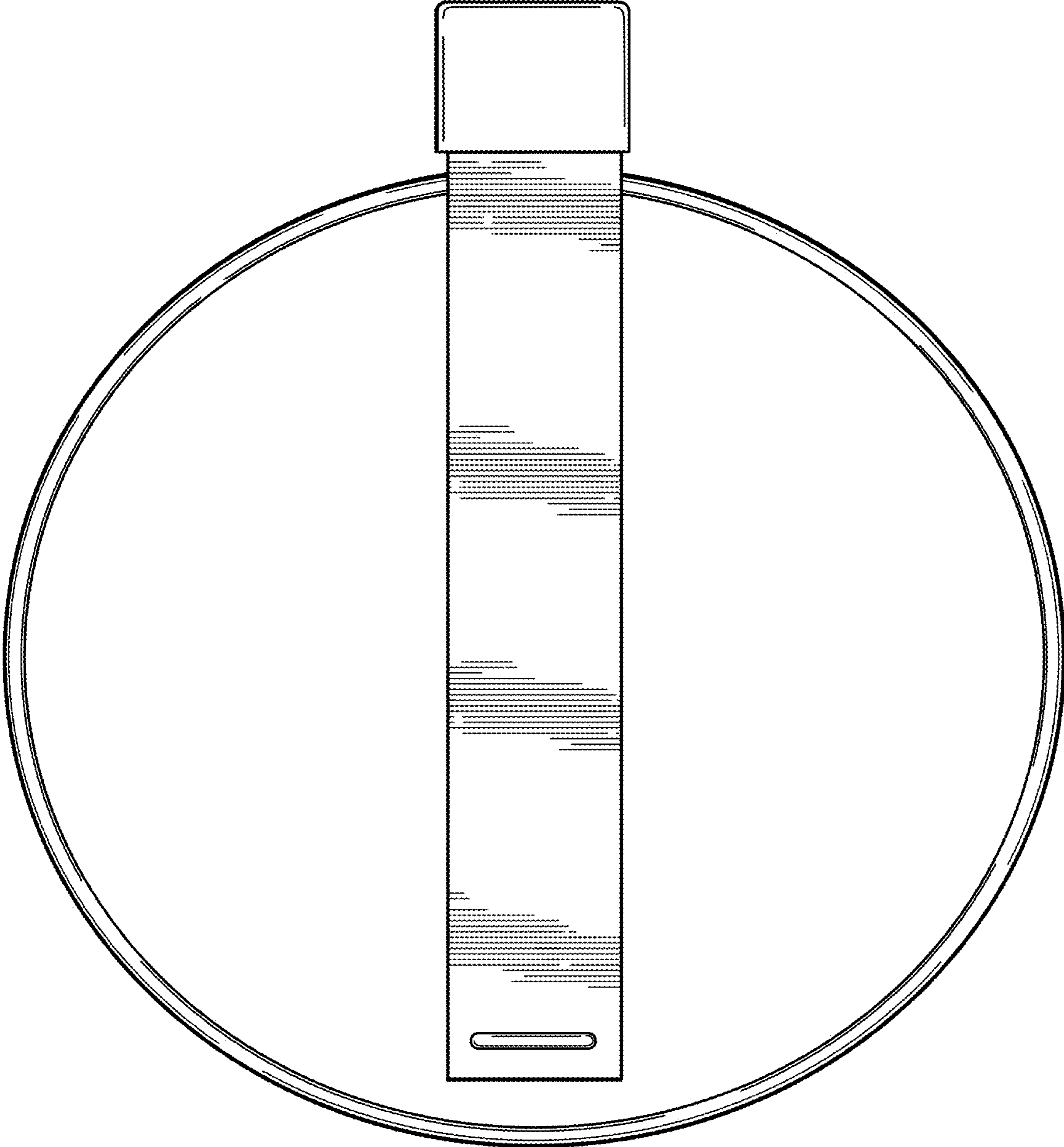

FIG. 24

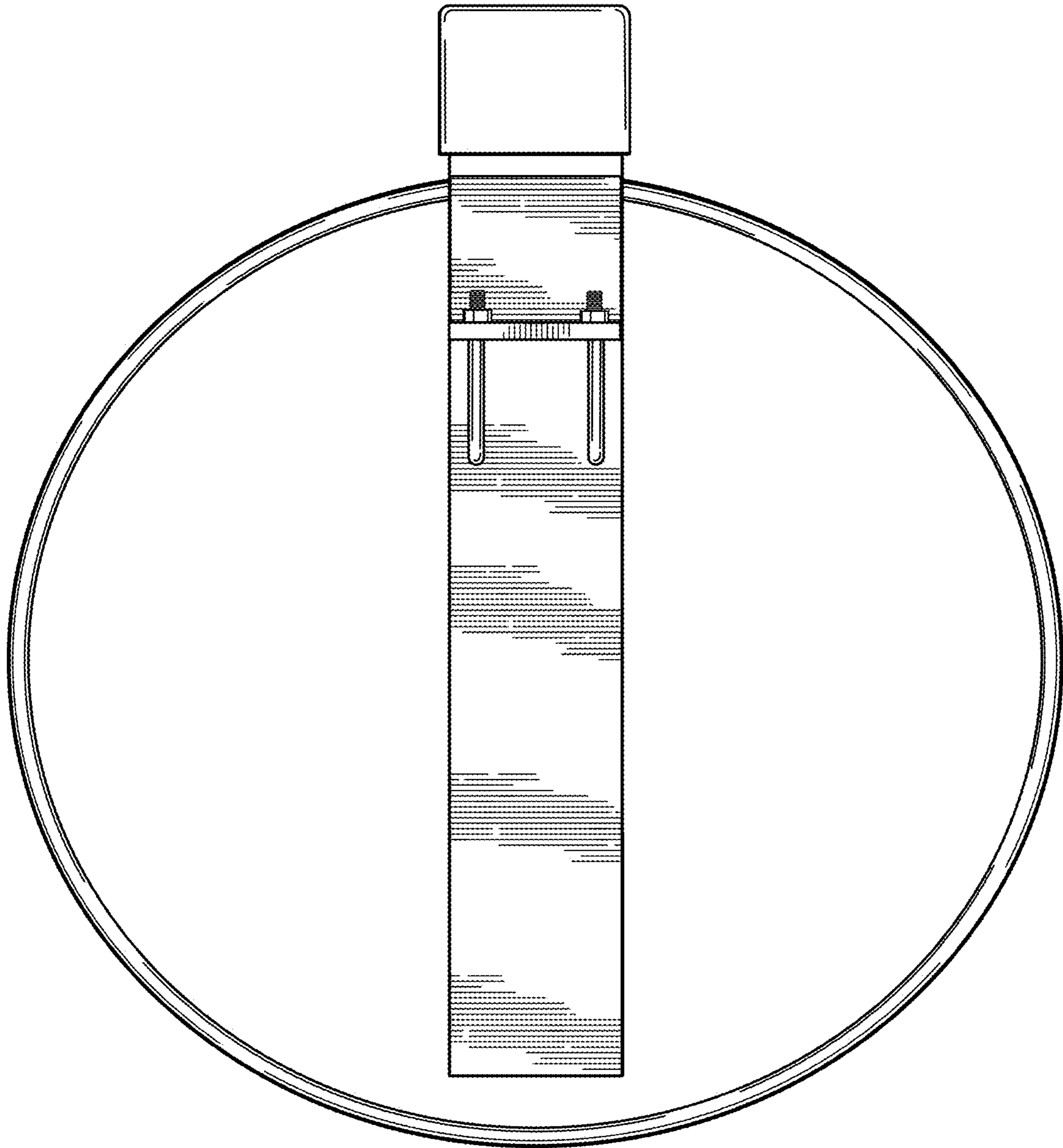

FIG. 25

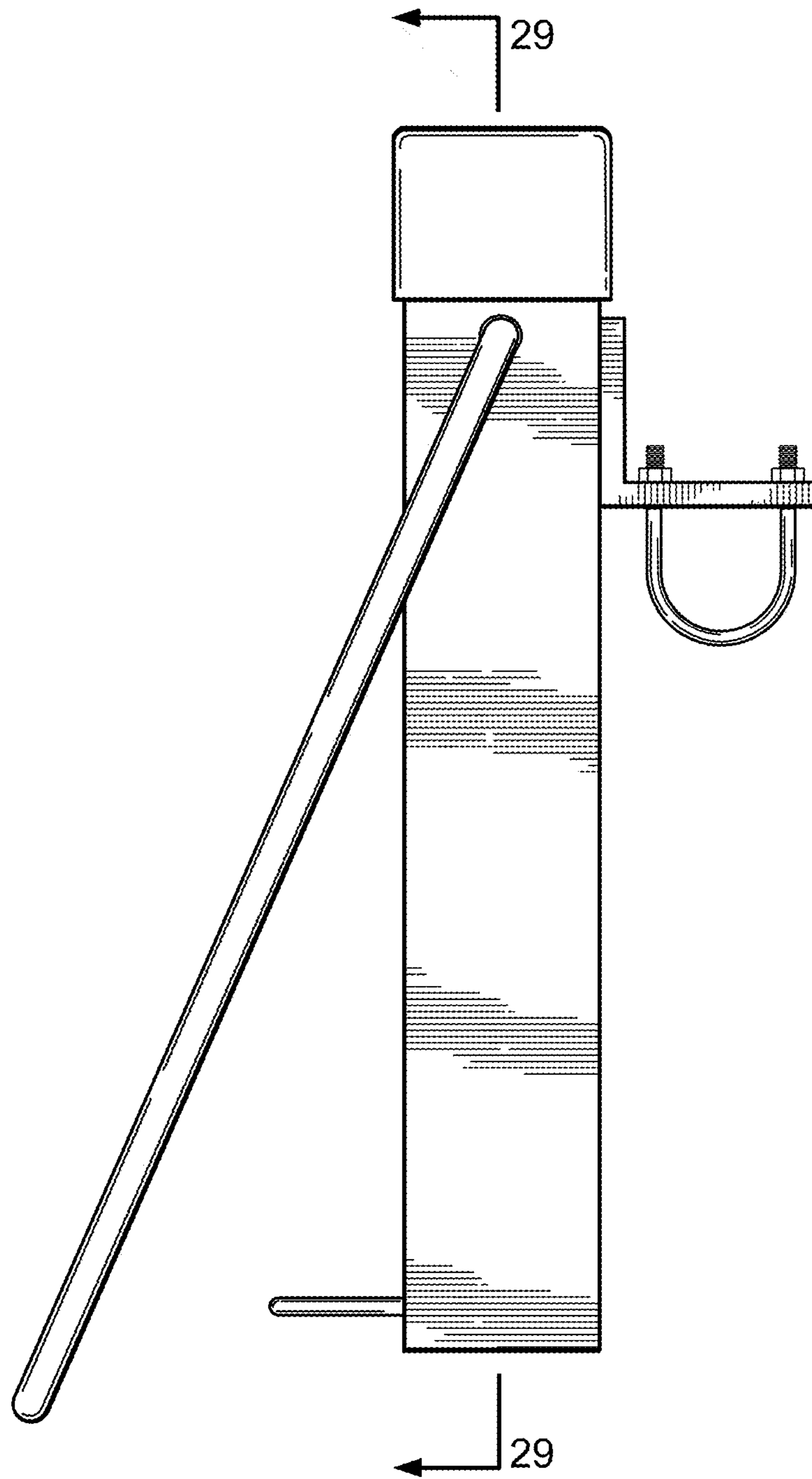

FIG. 26

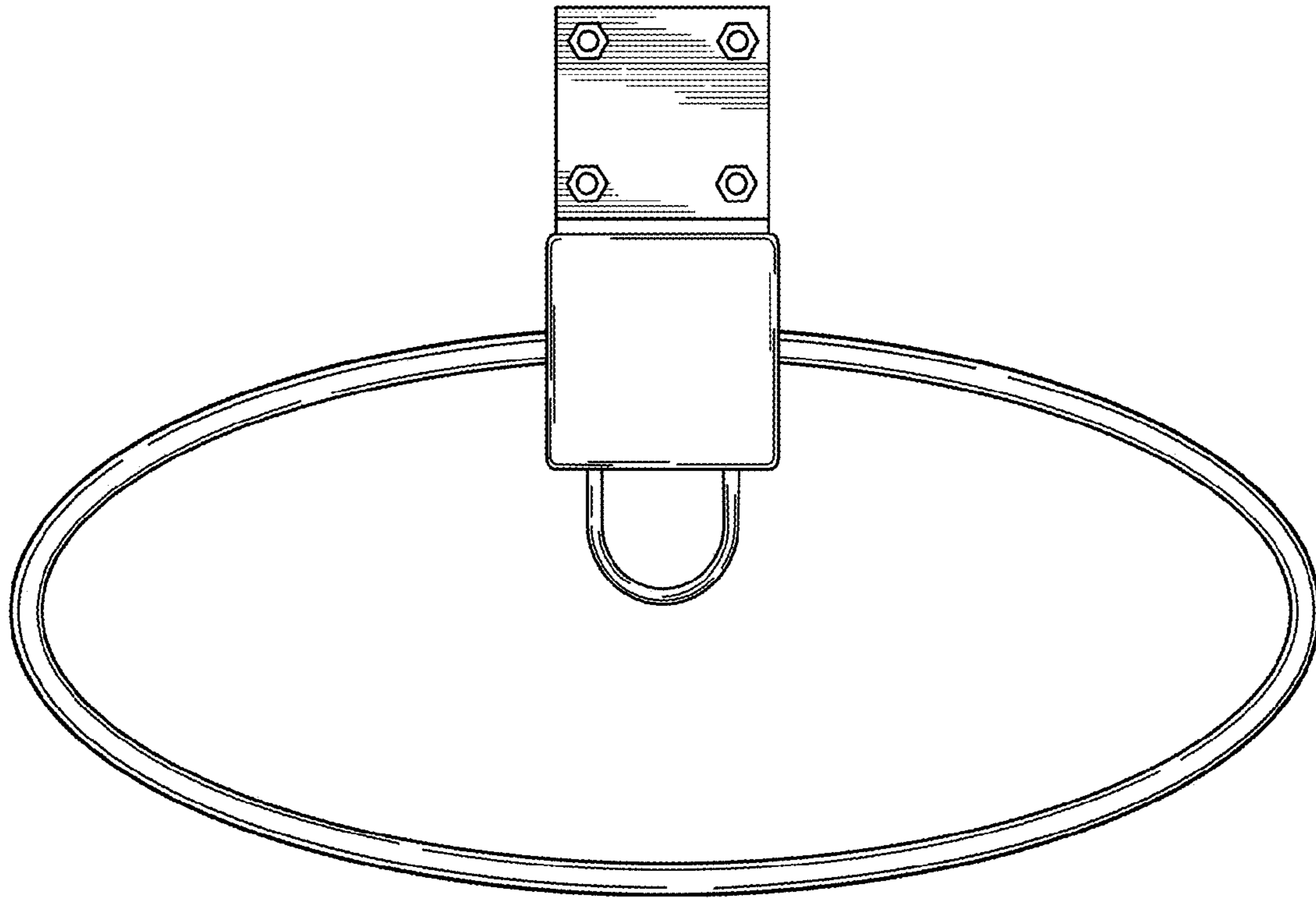

FIG. 27

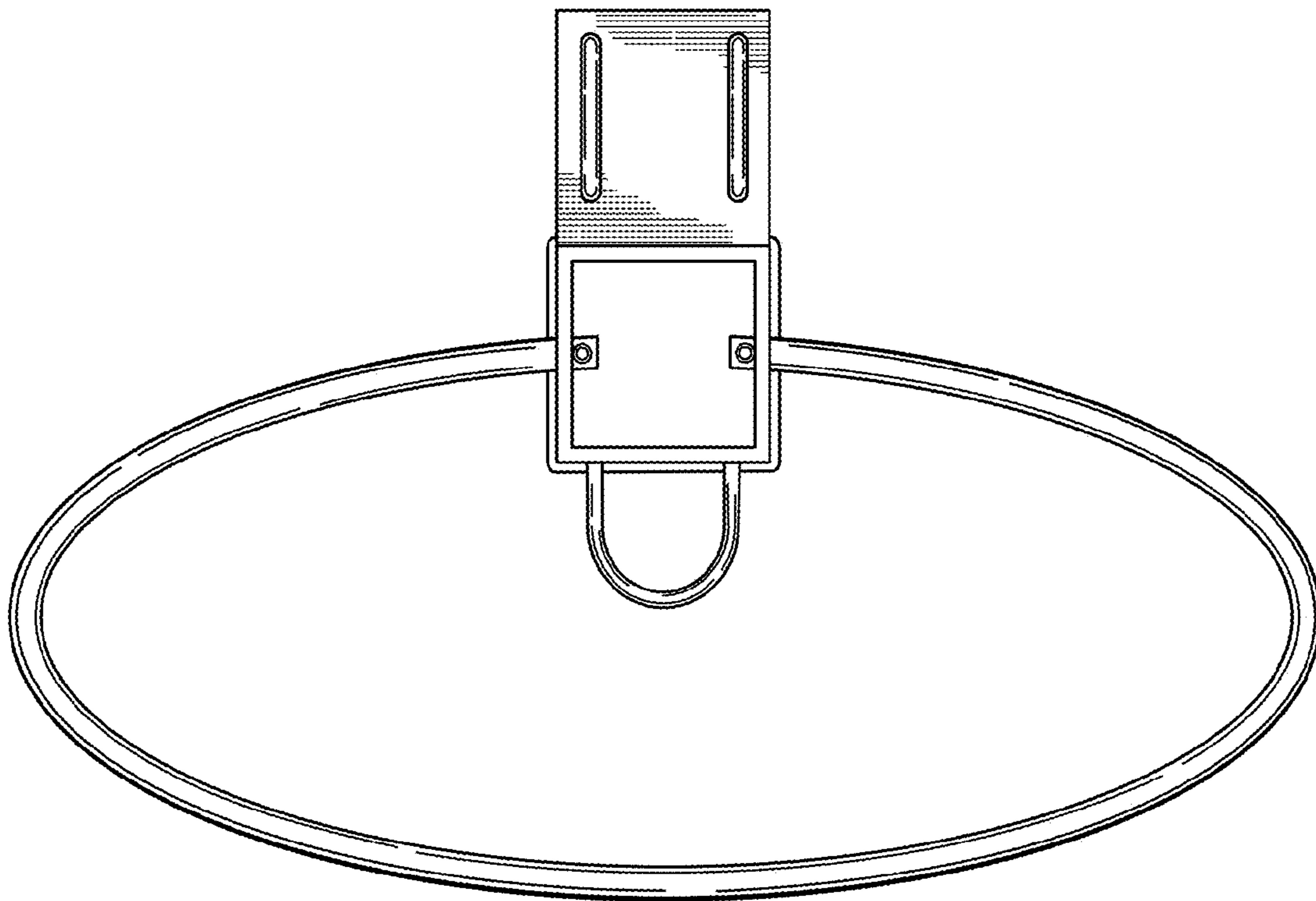

FIG. 28

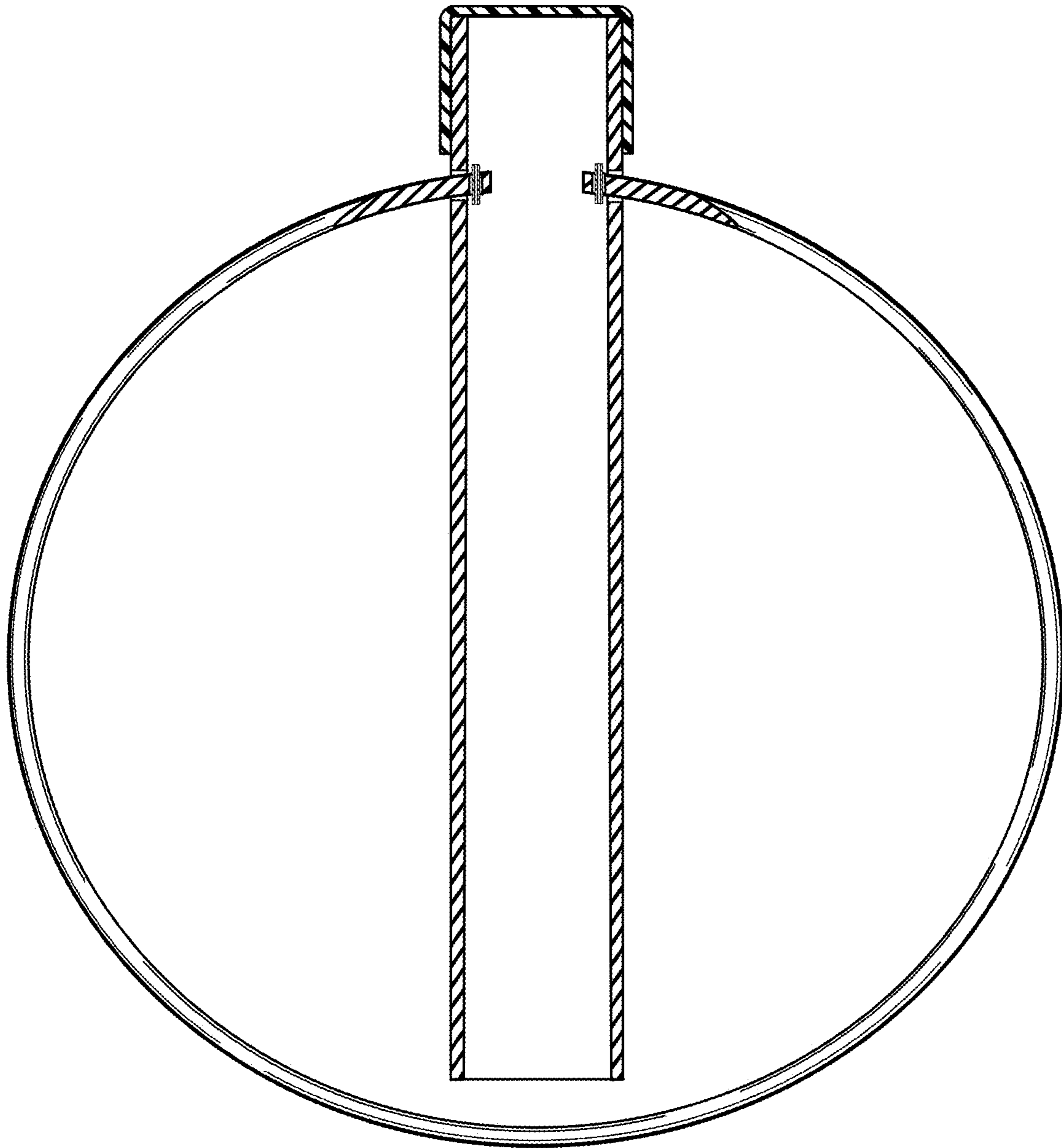

FIG. 29

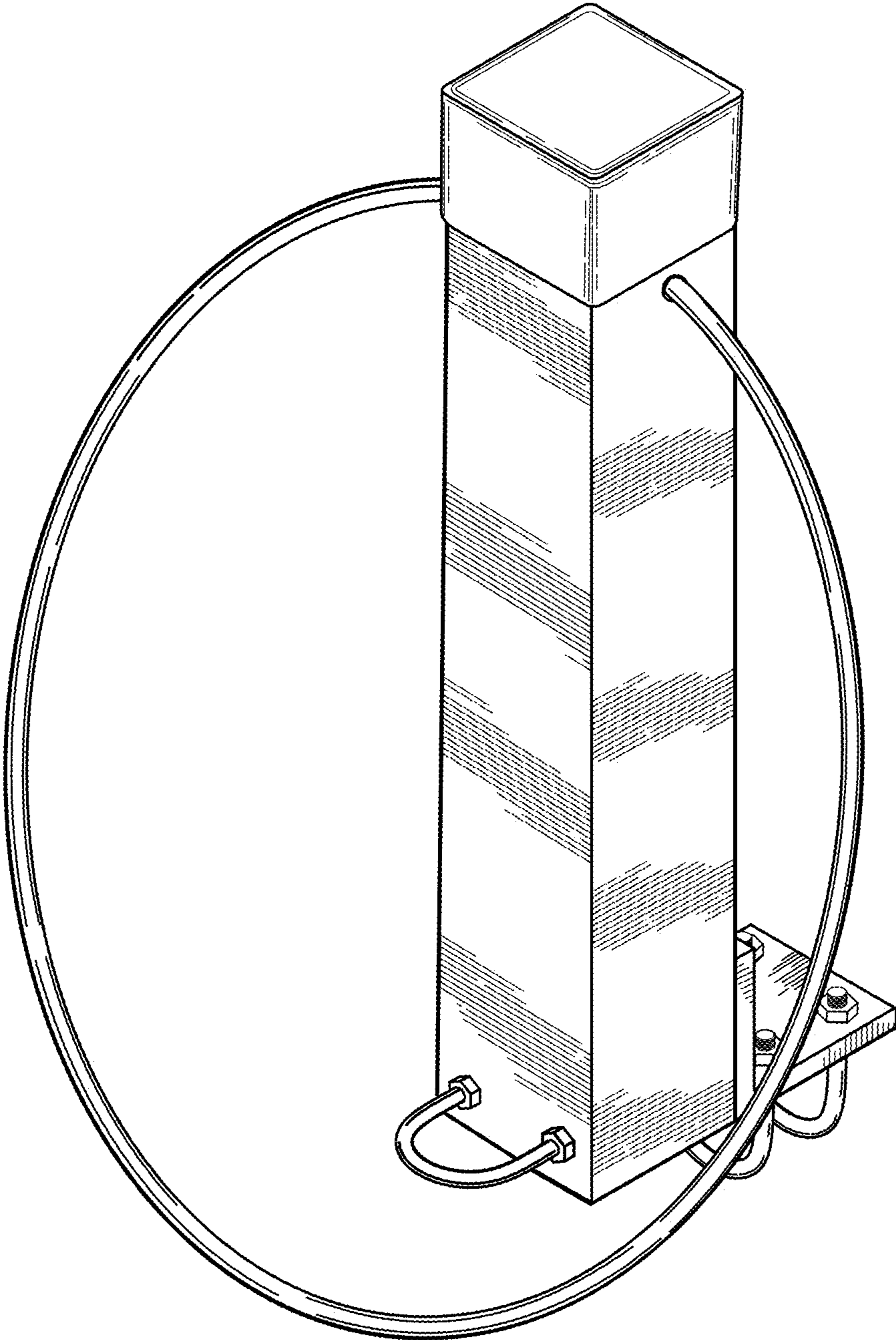

FIG. 30

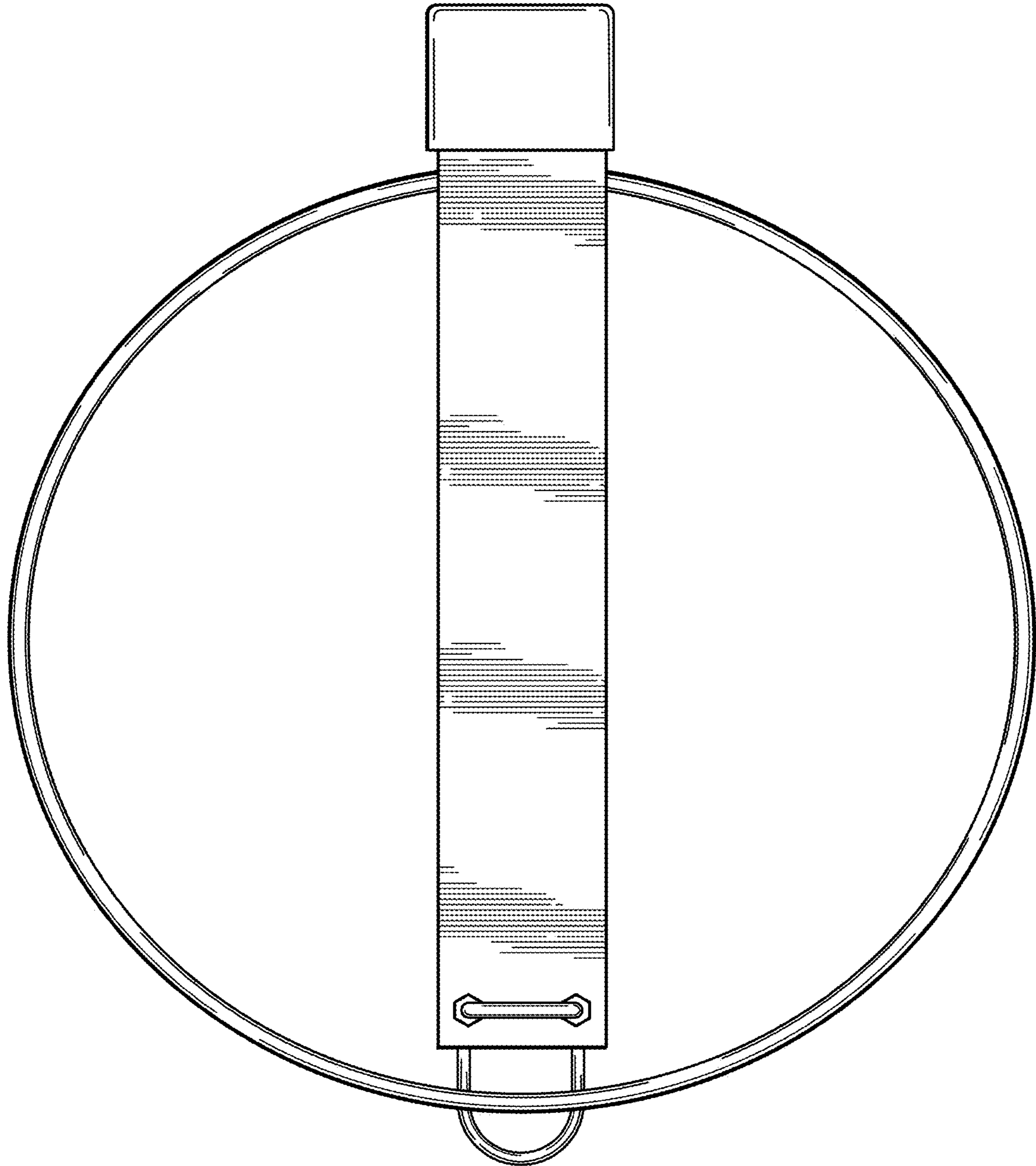

FIG. 31

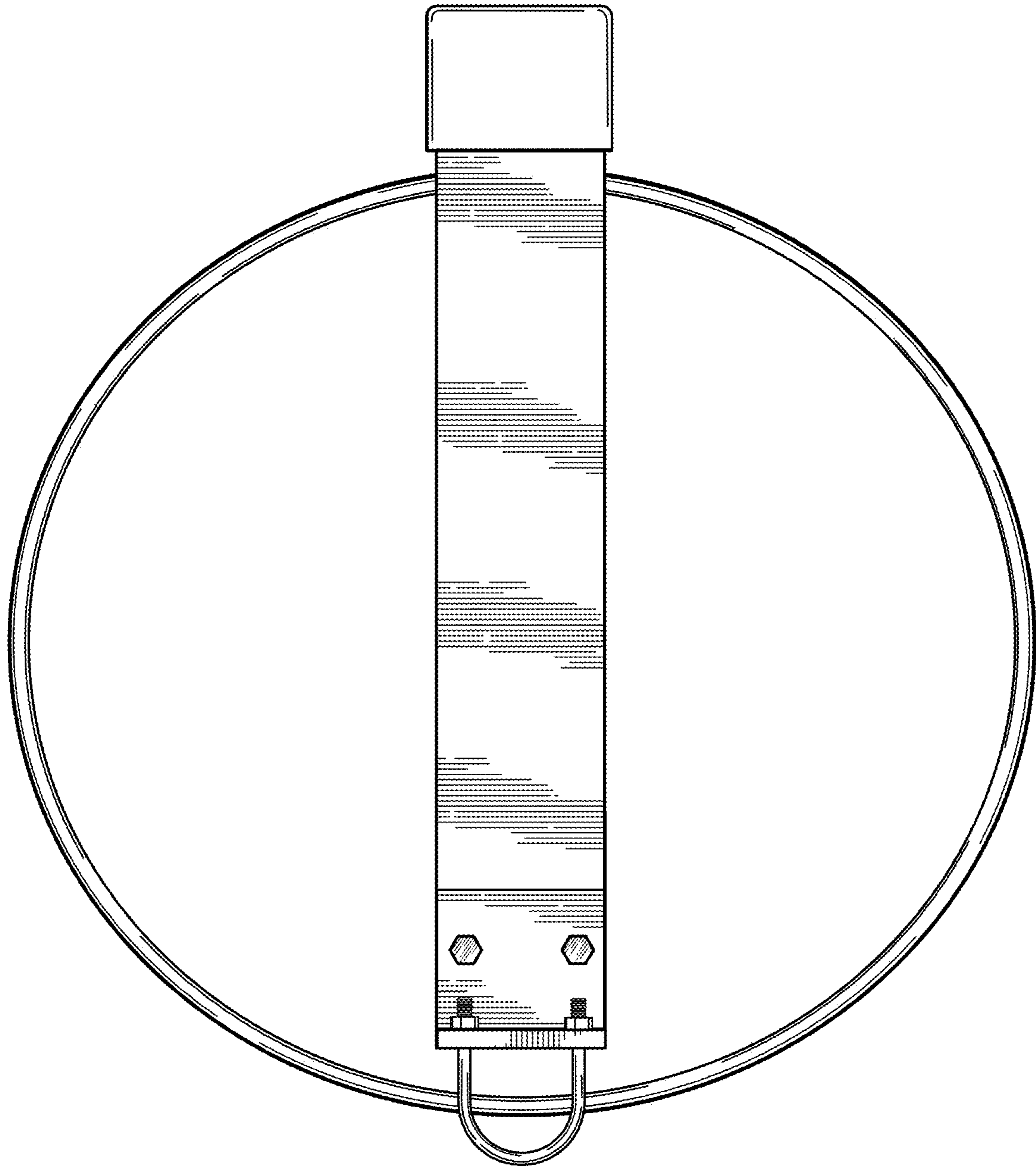

FIG. 32

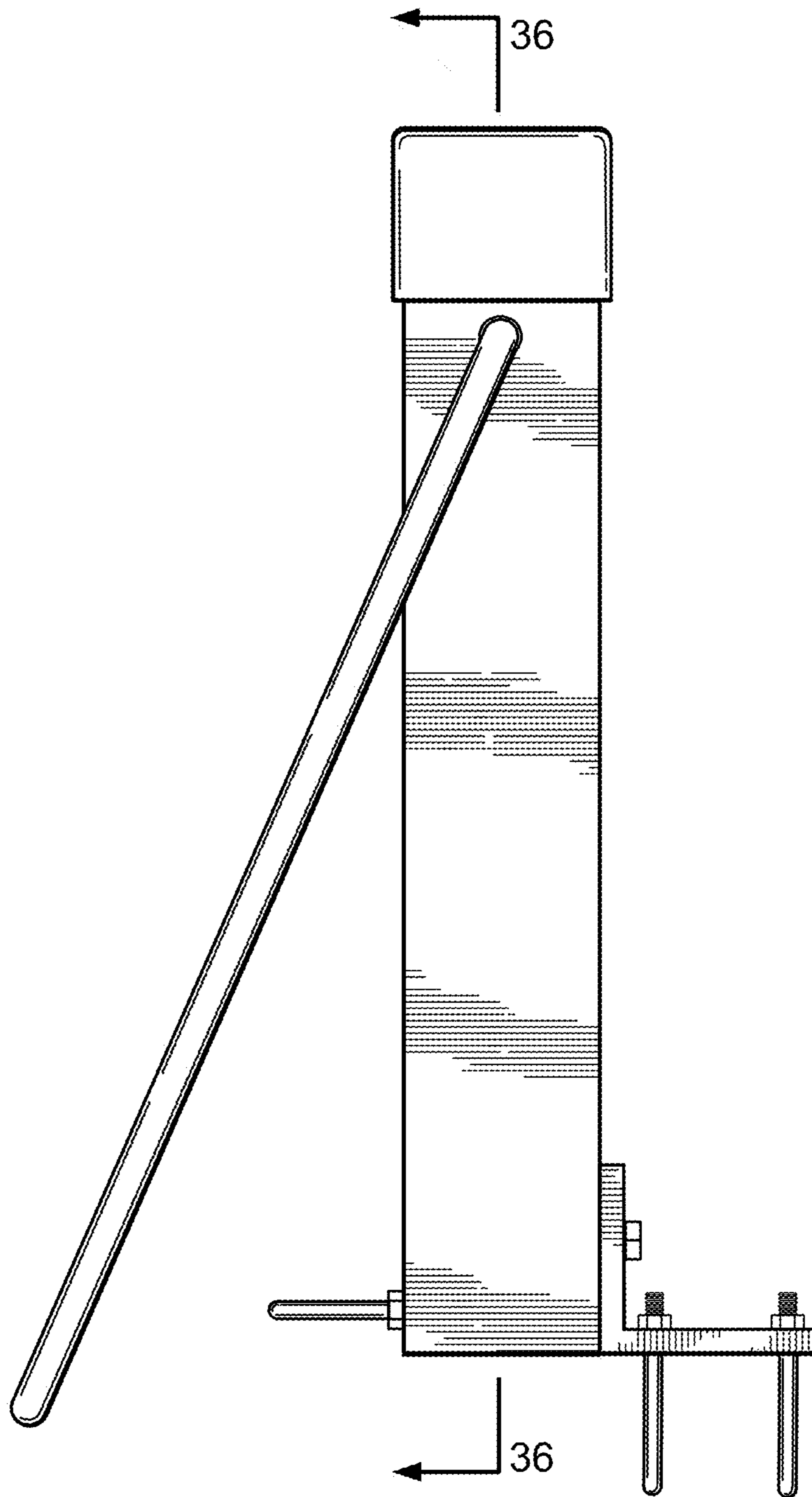

FIG. 33

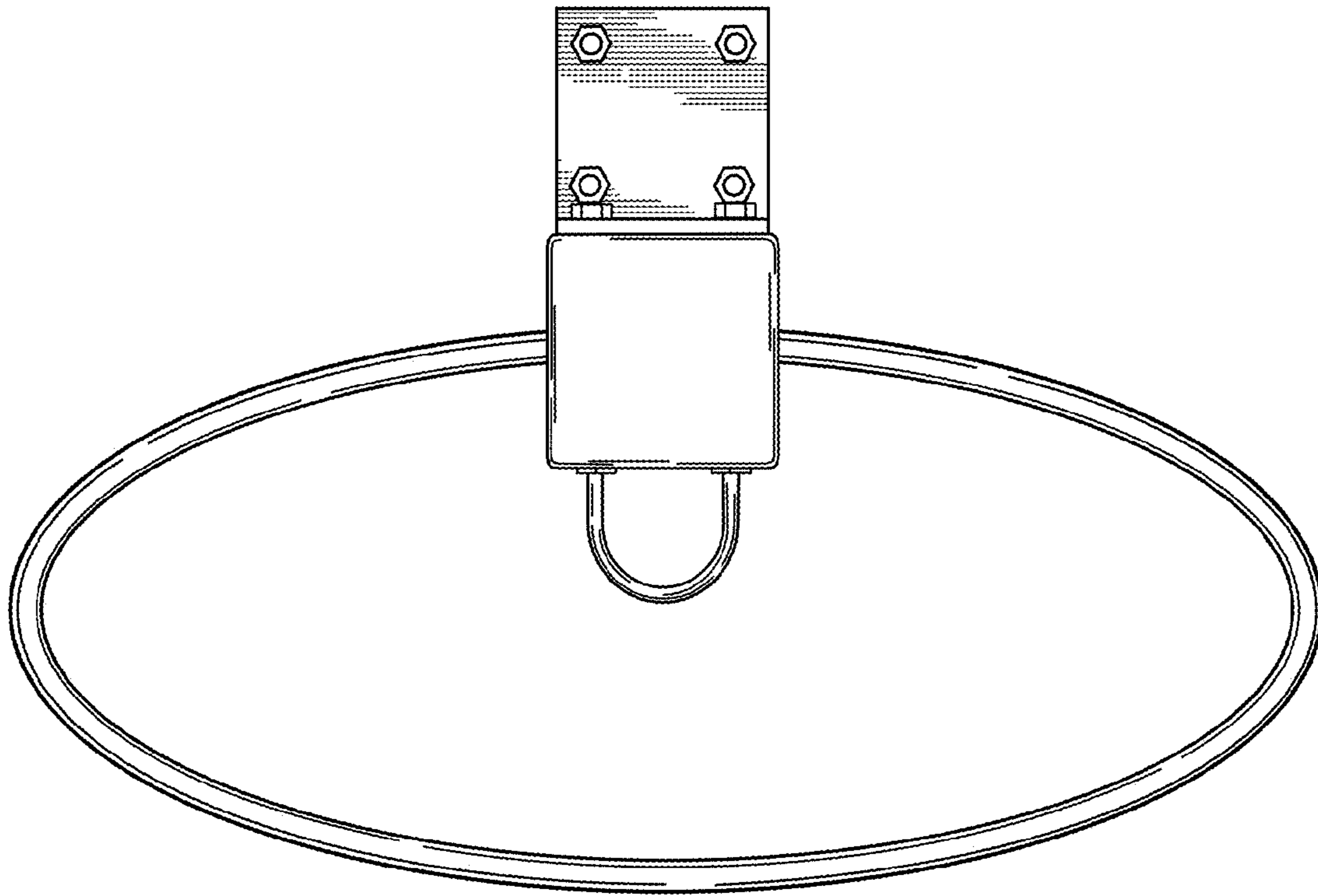

FIG. 34

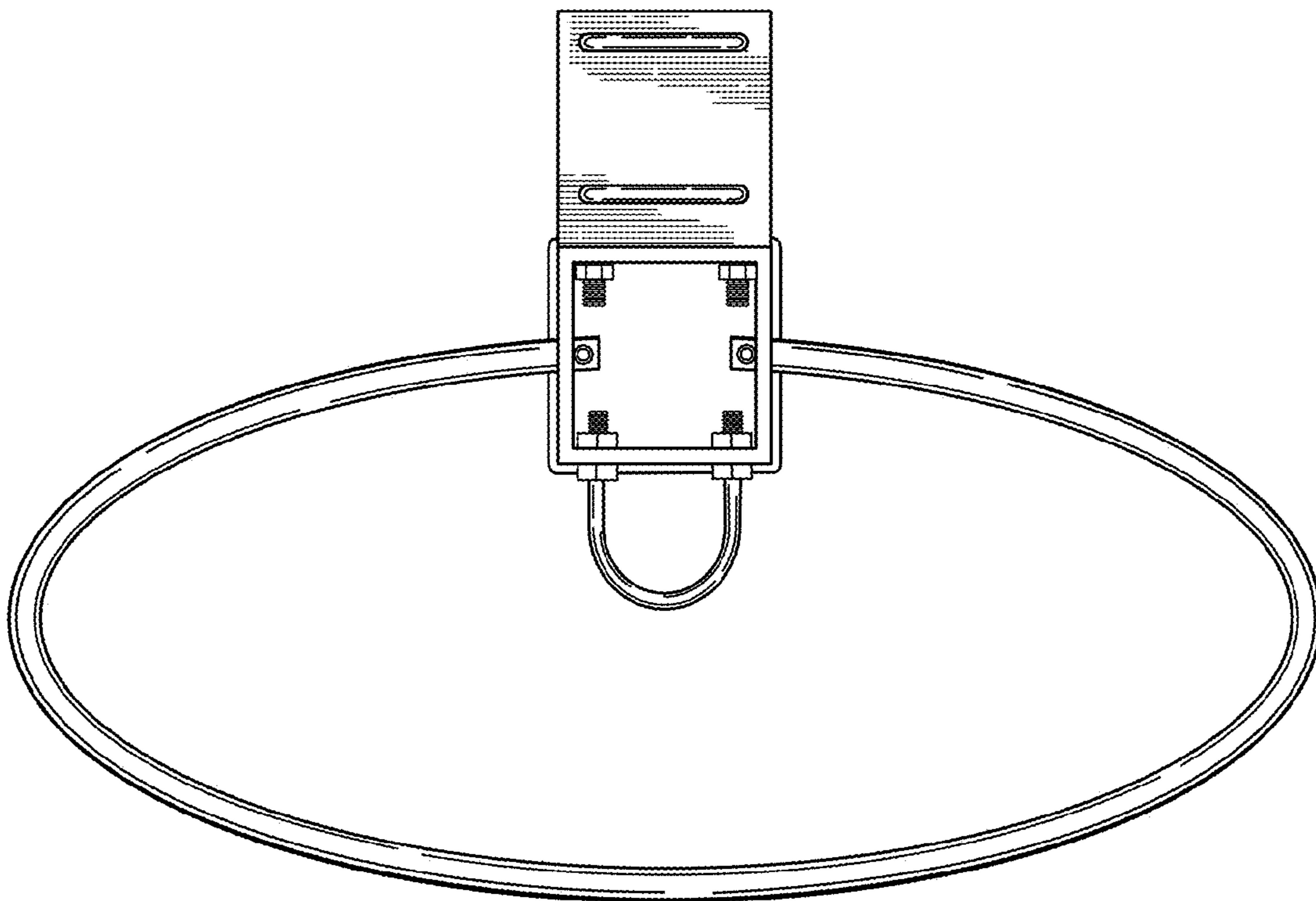

FIG. 35

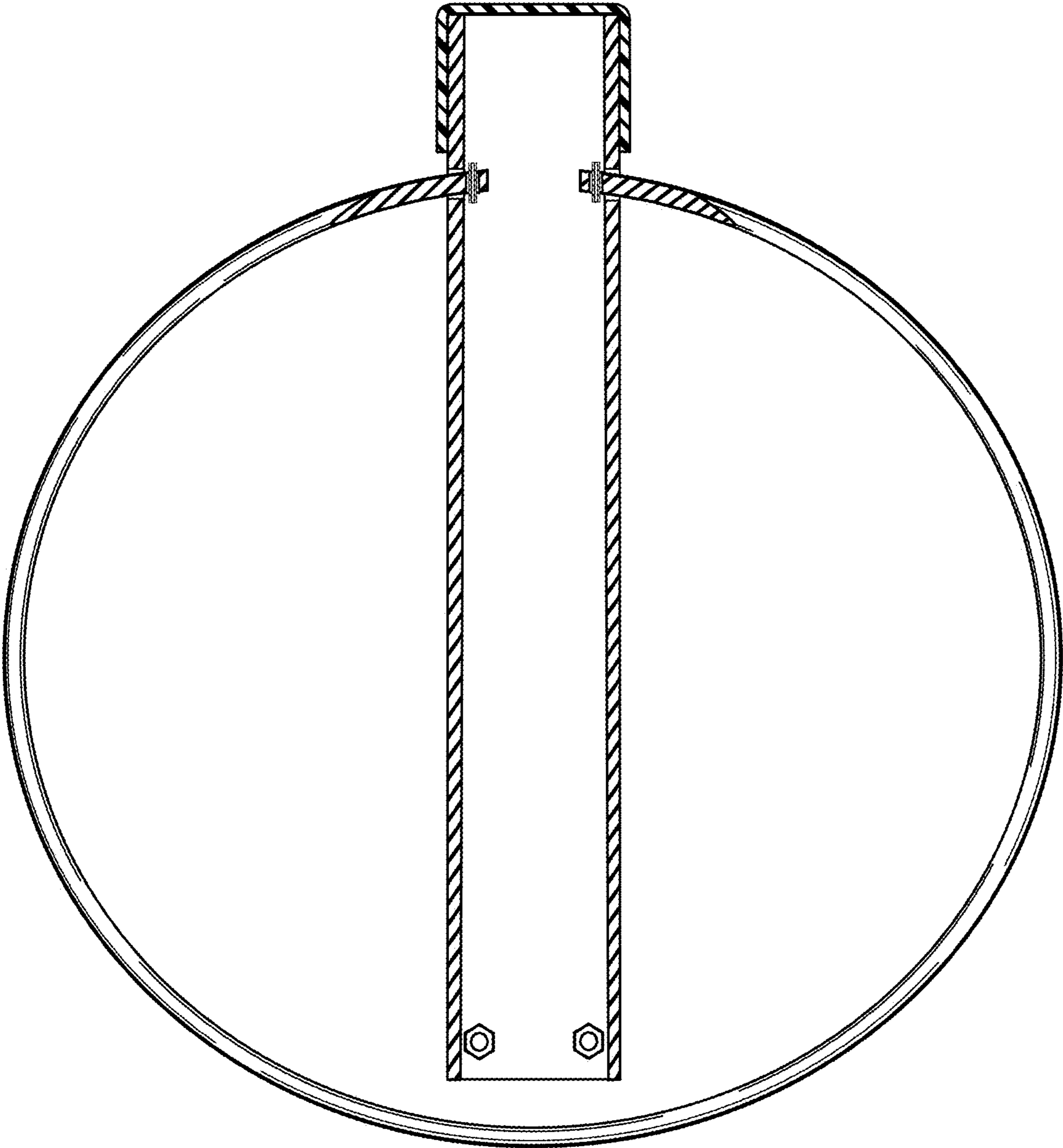

FIG. 36

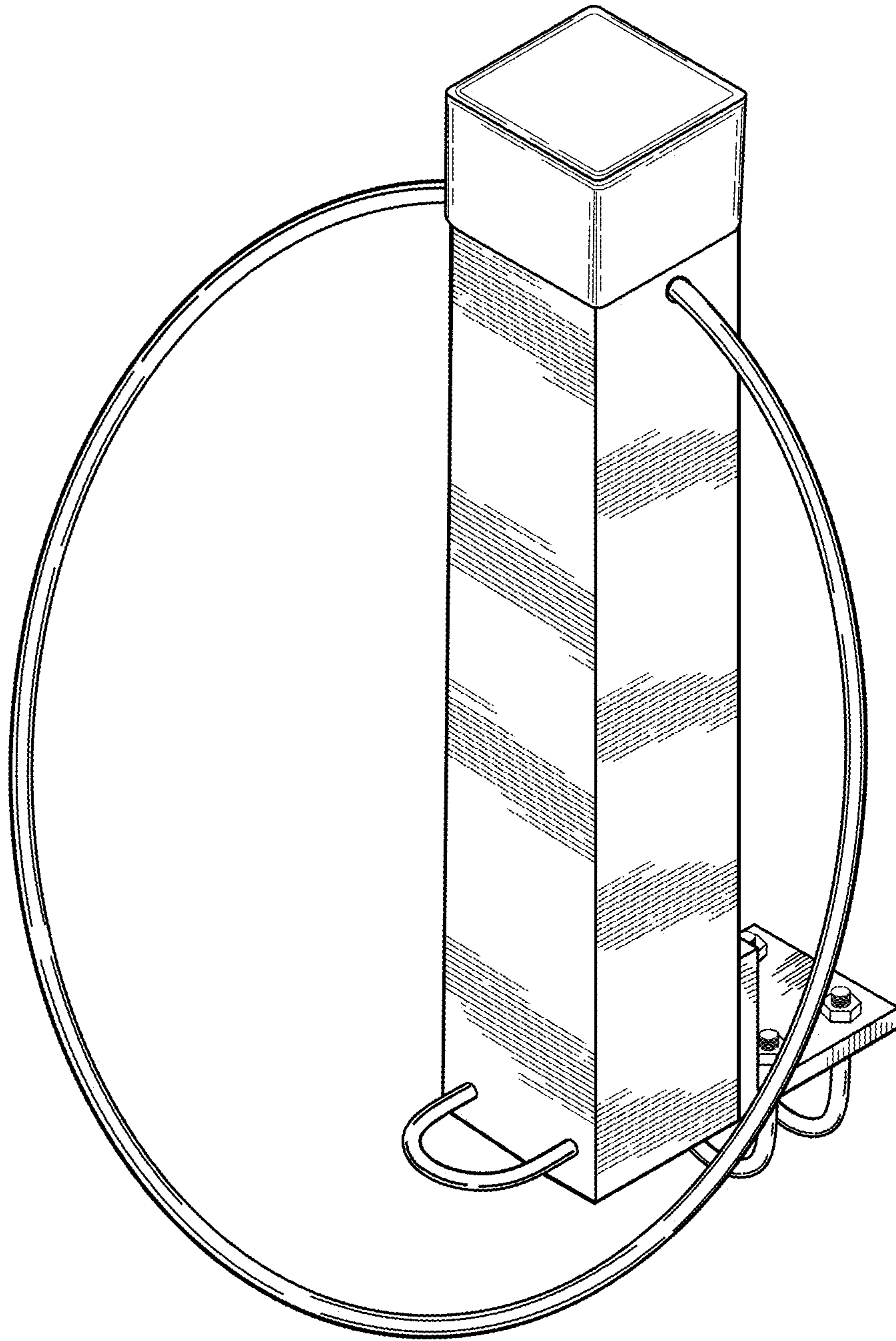

FIG. 37

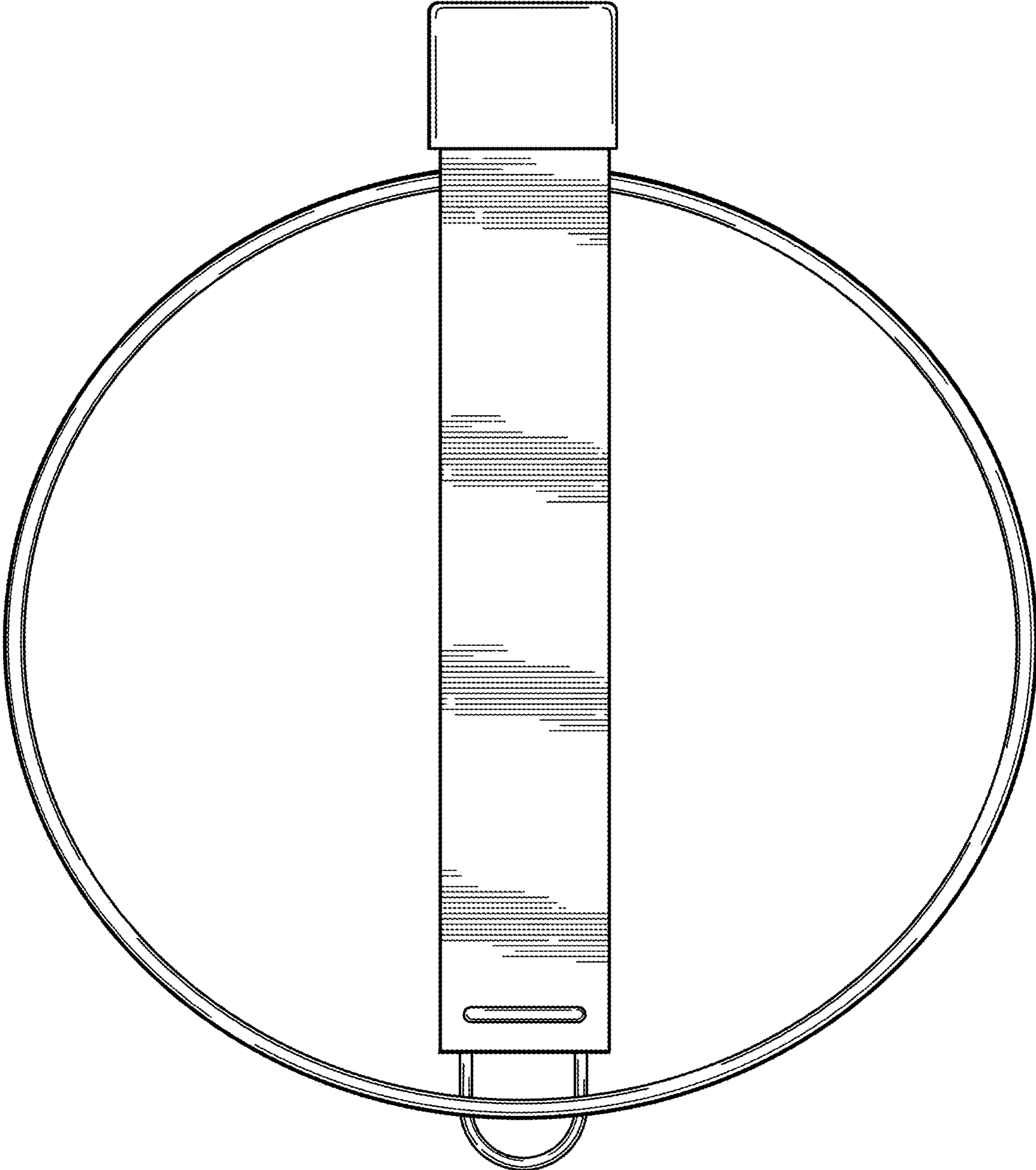

FIG. 38

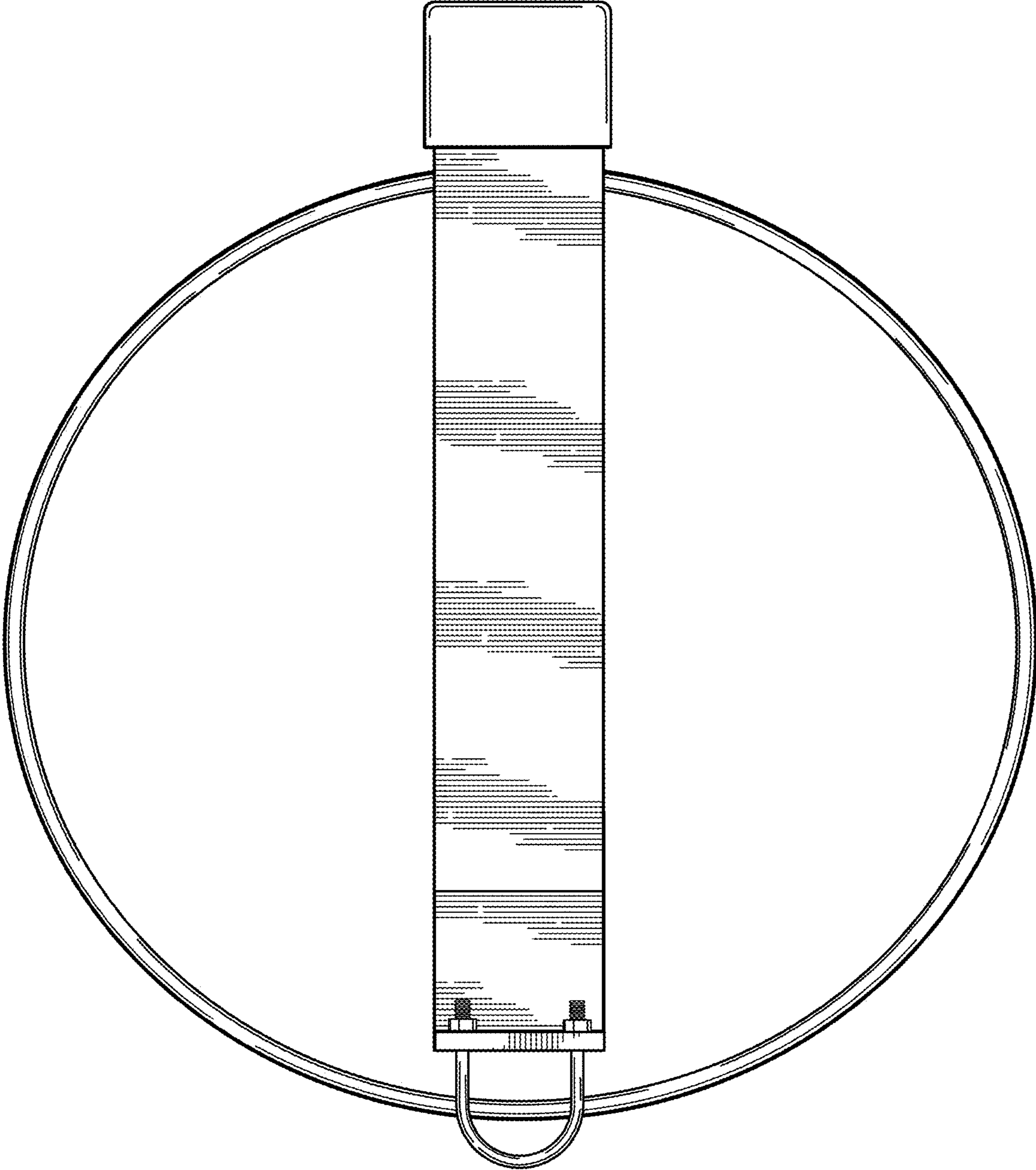

FIG. 39

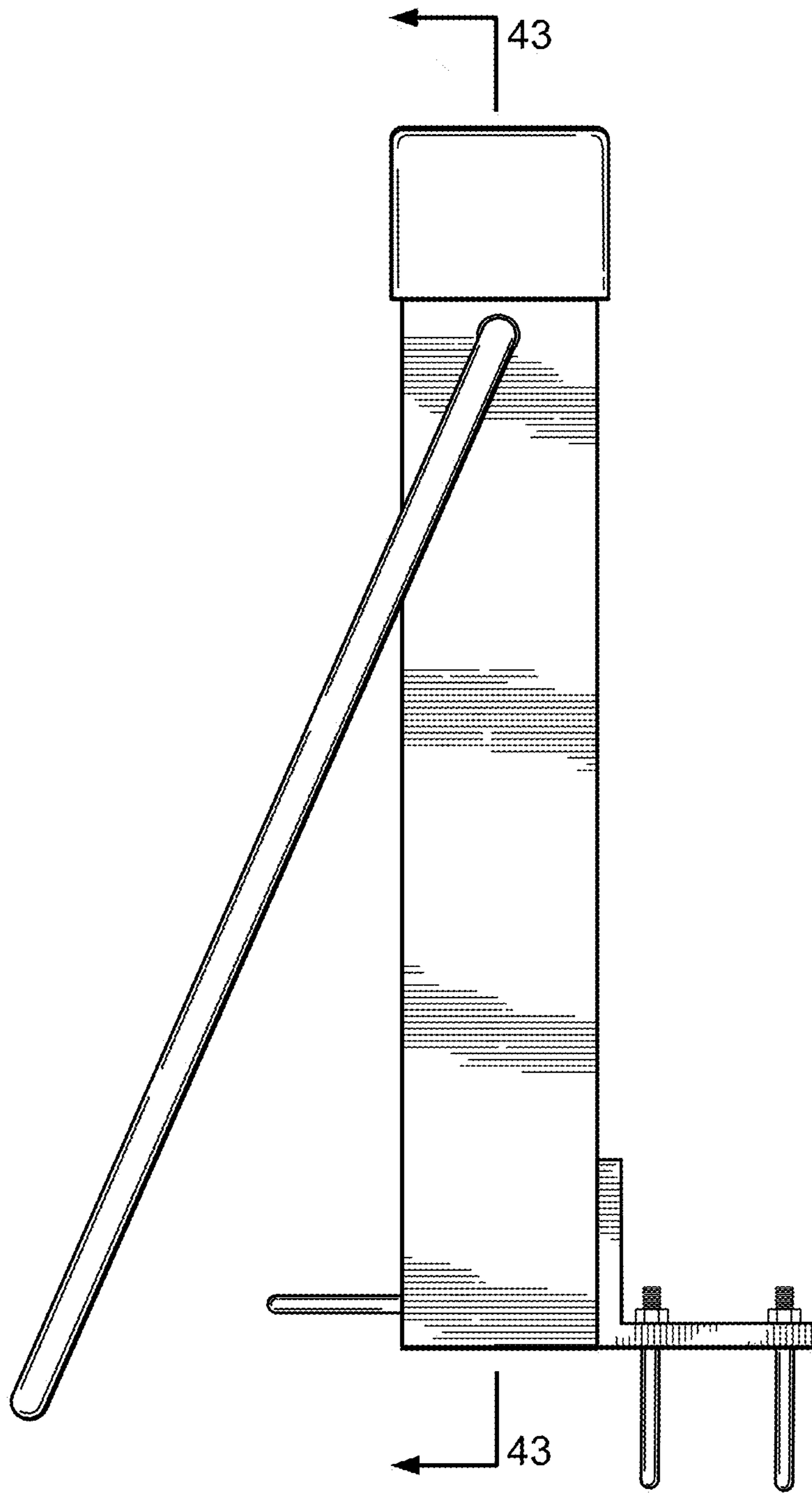

FIG. 40

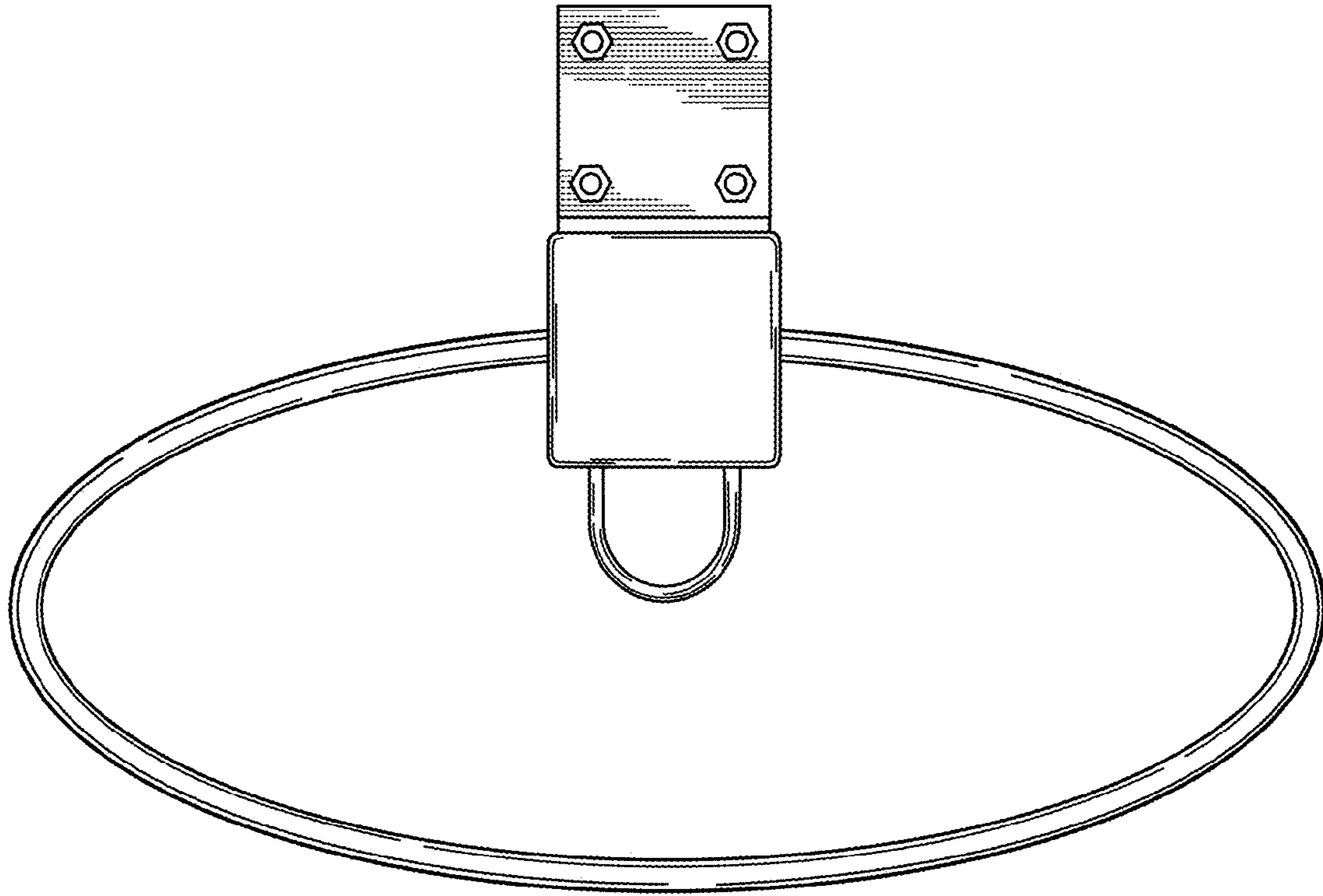

FIG. 41

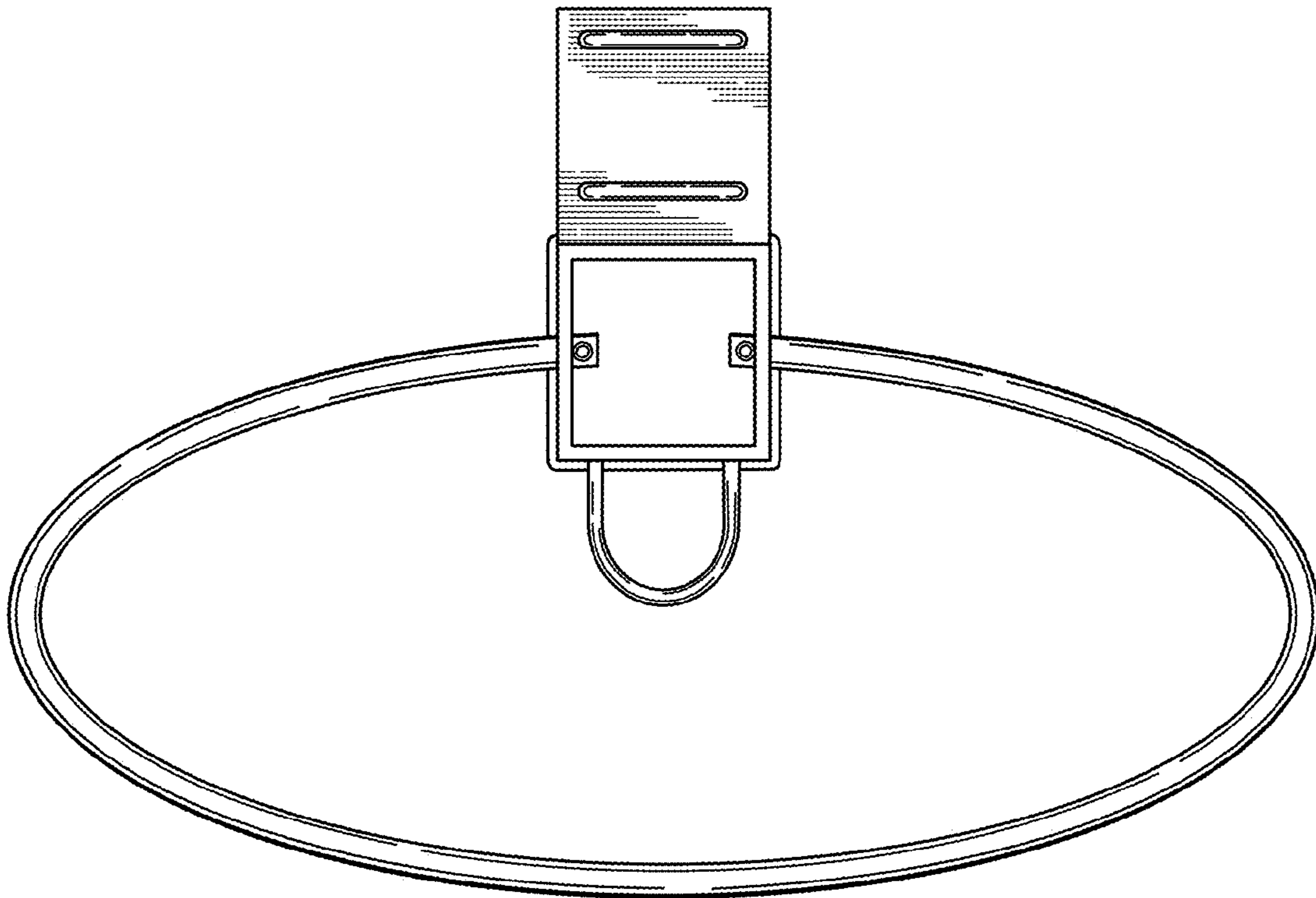

FIG. 42

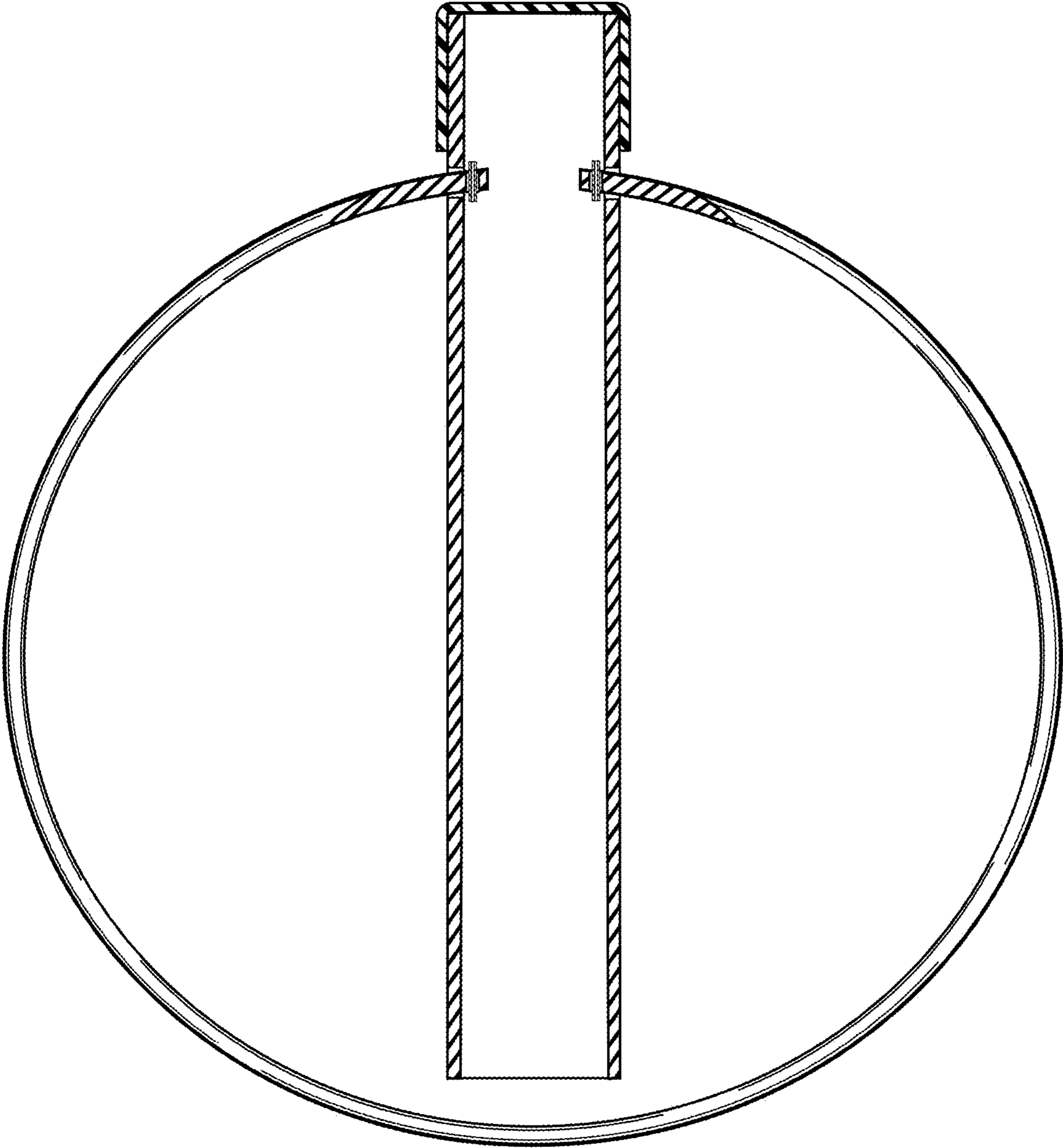

FIG. 43

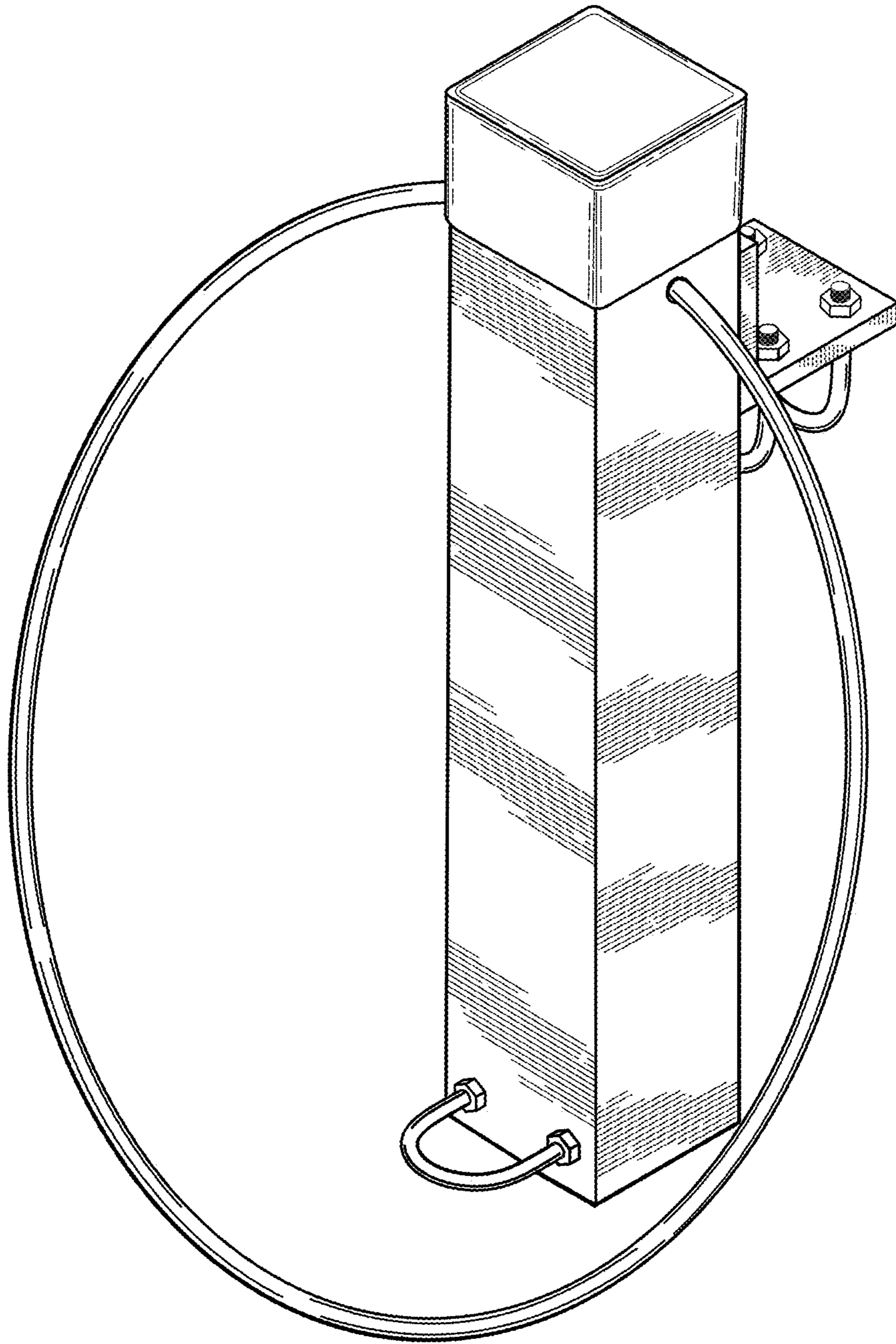

FIG. 44

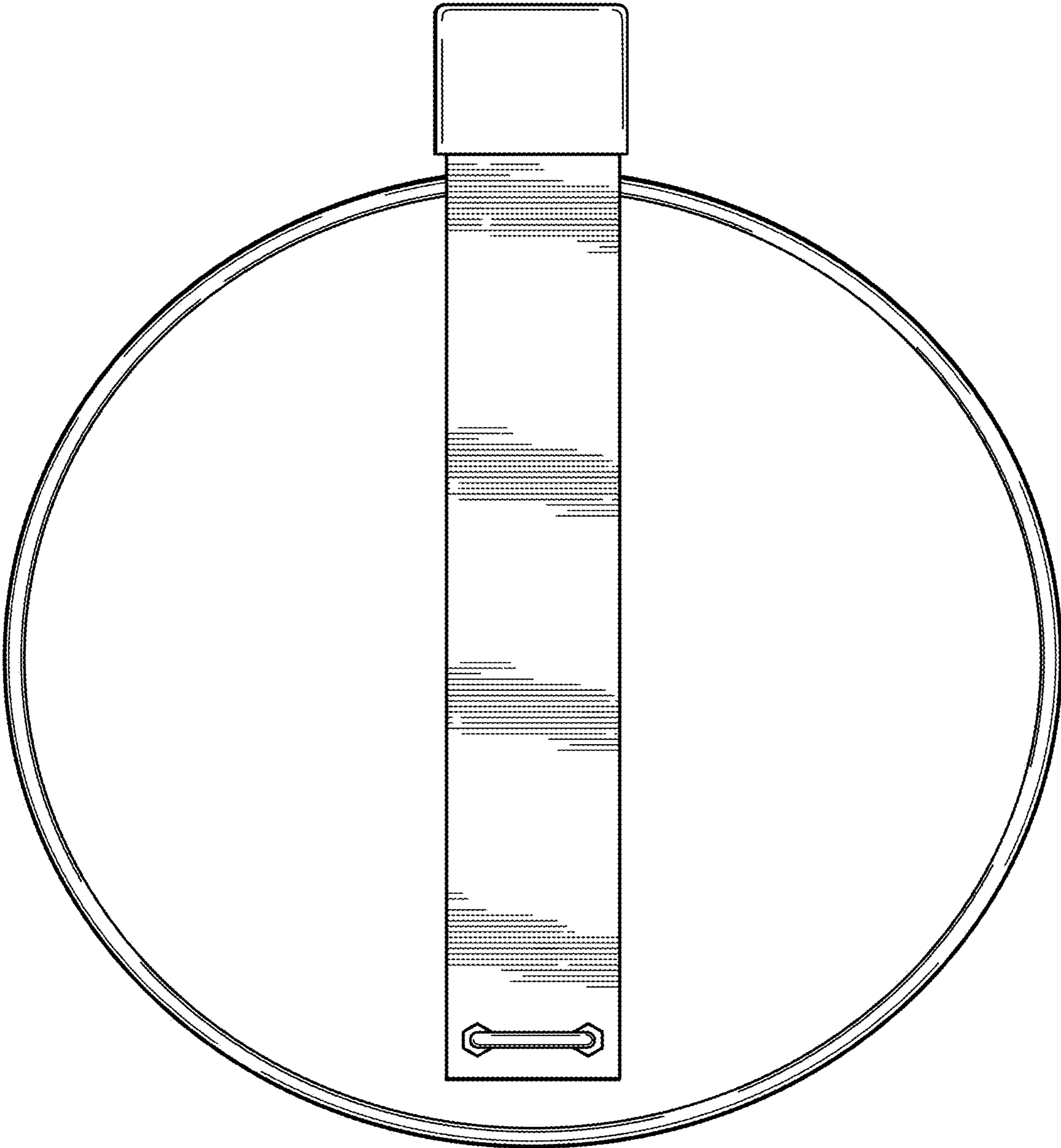

FIG. 45

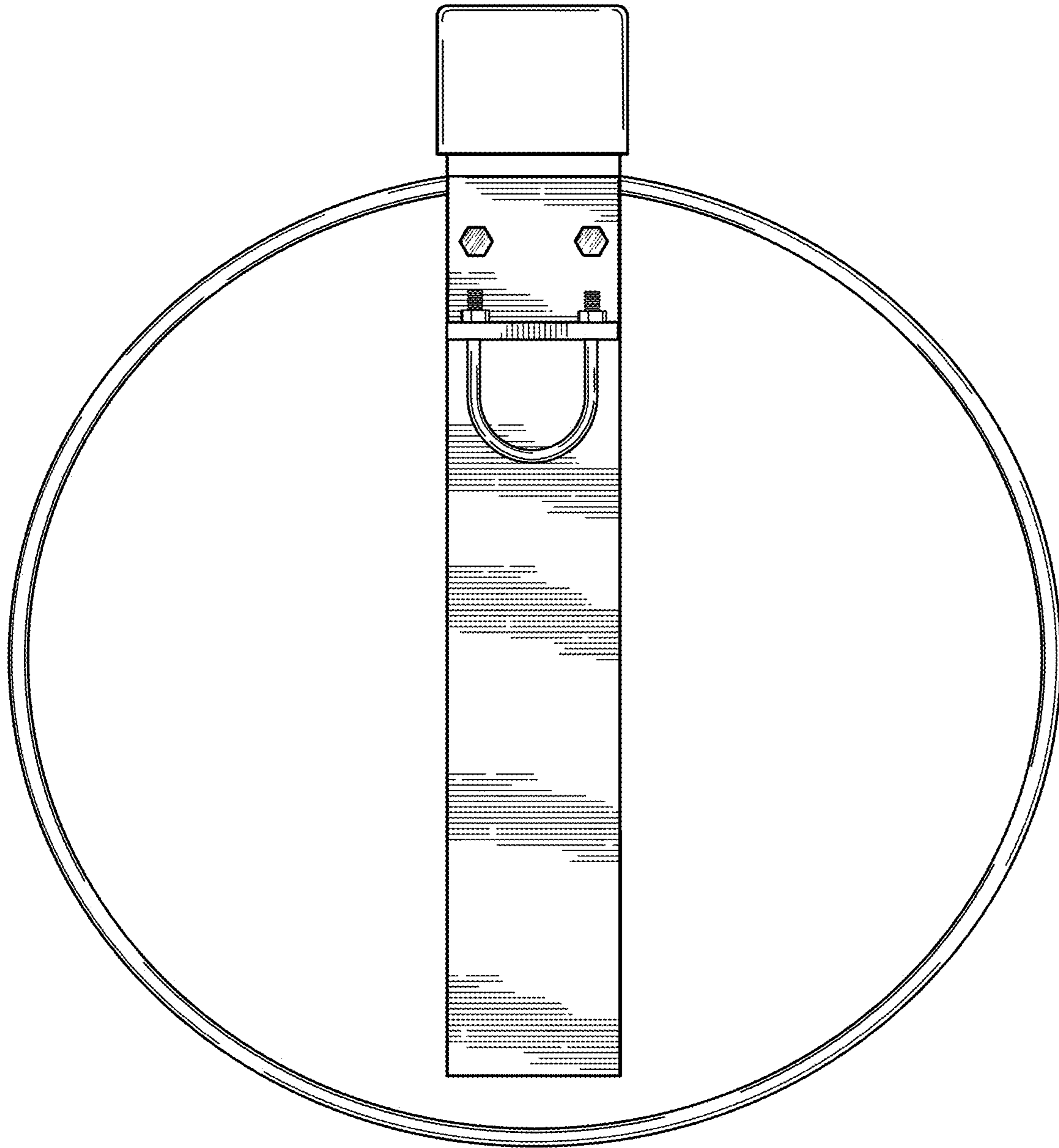

FIG. 46

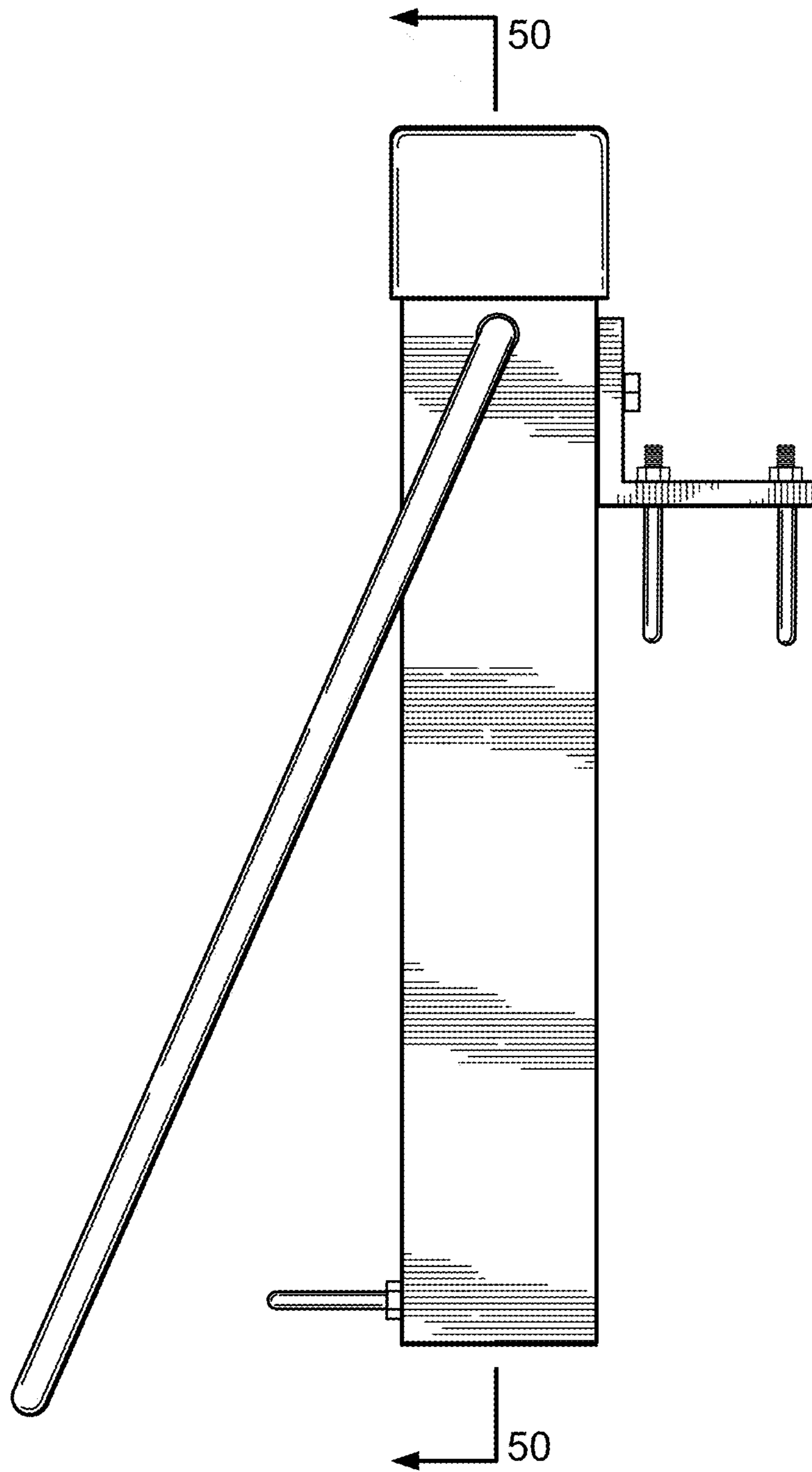

FIG. 47

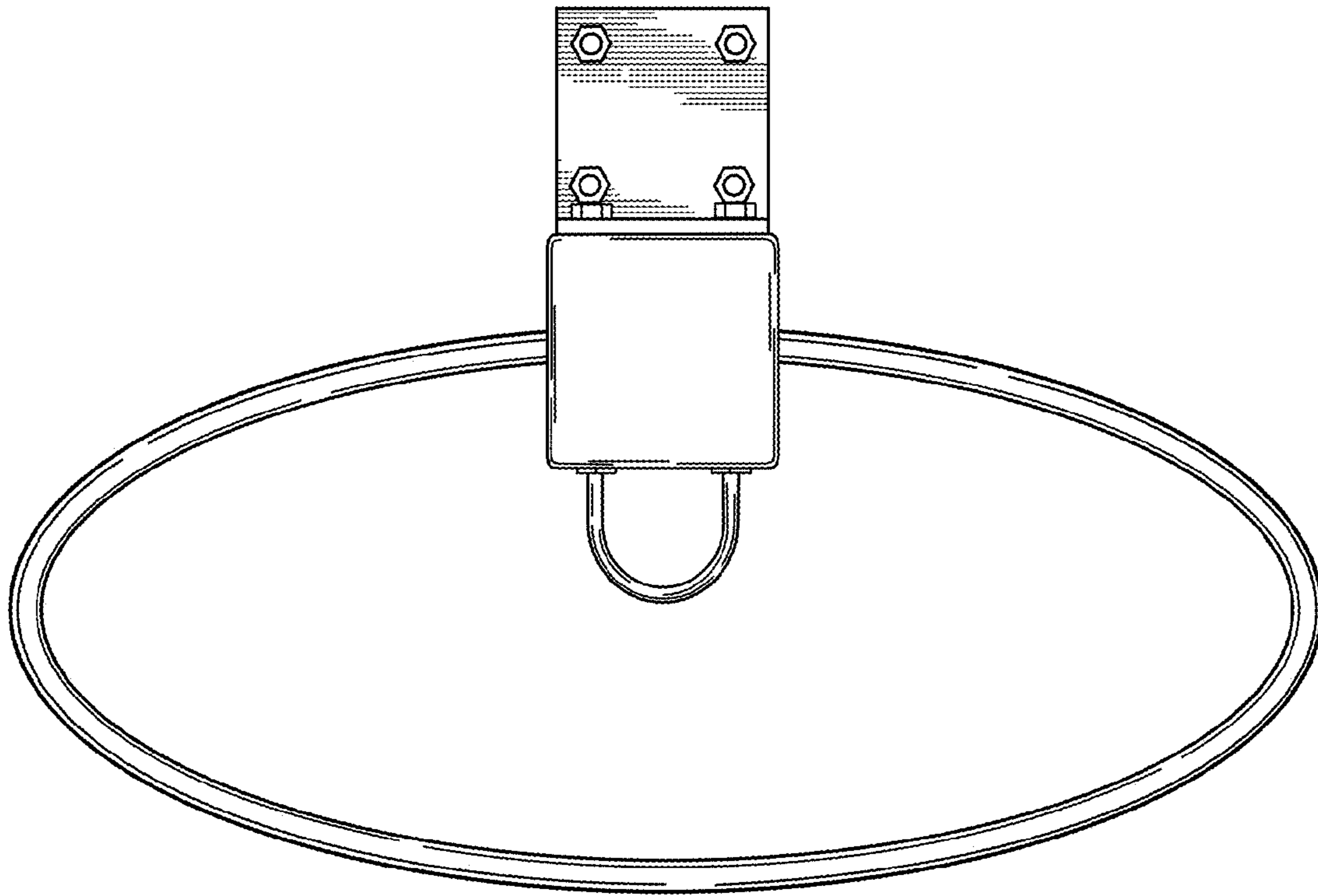

FIG. 48

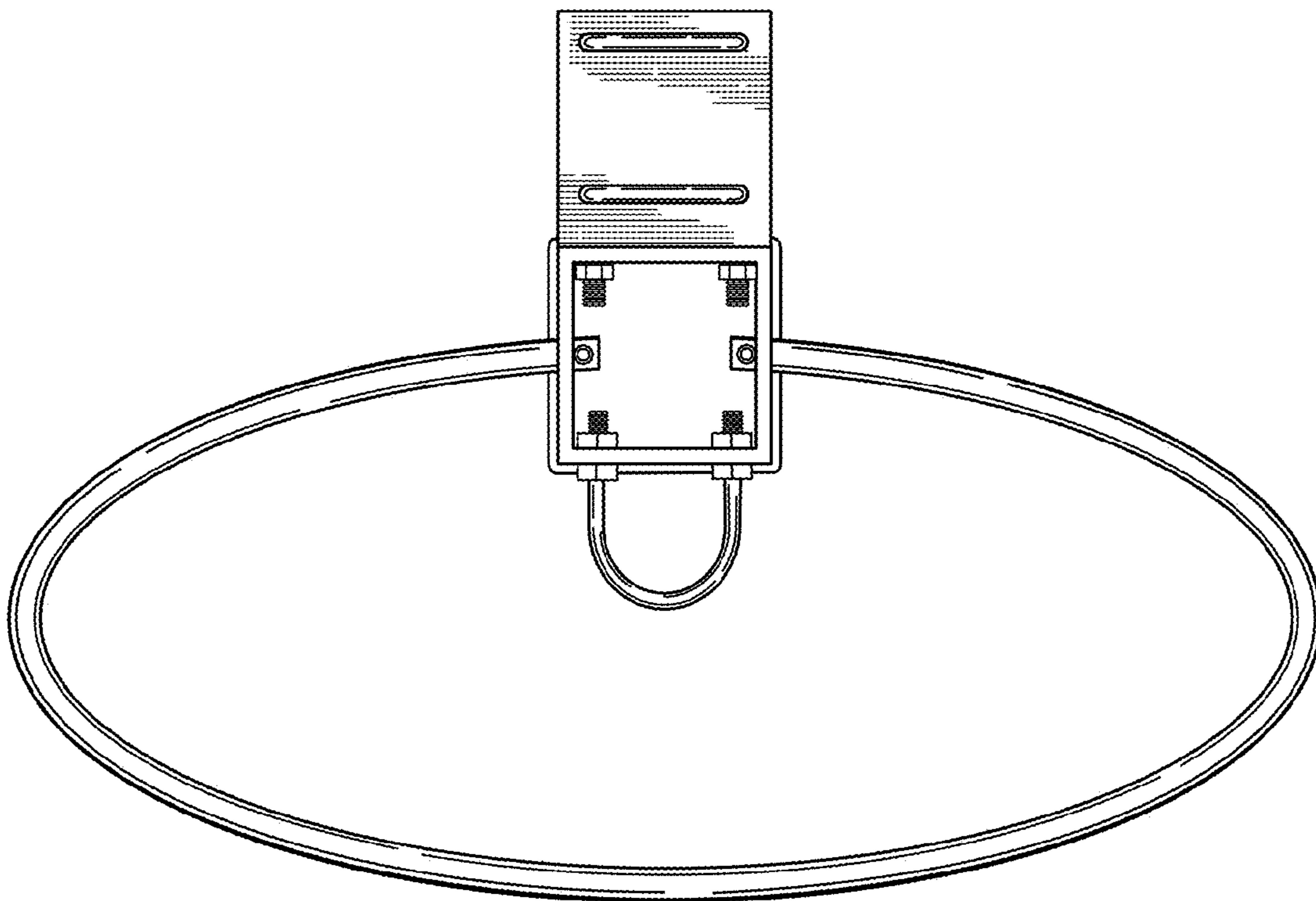

FIG. 49

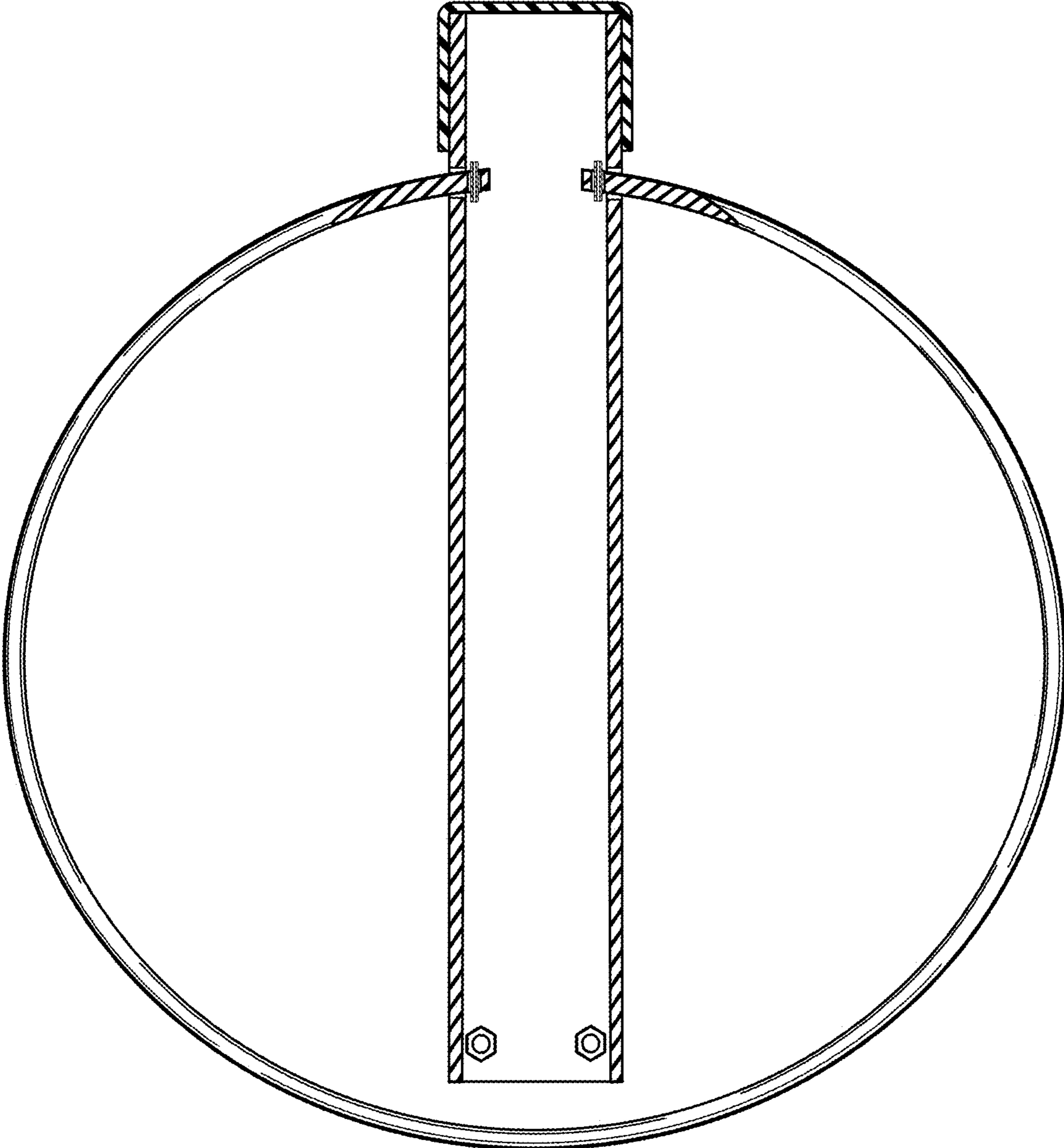

FIG. 50

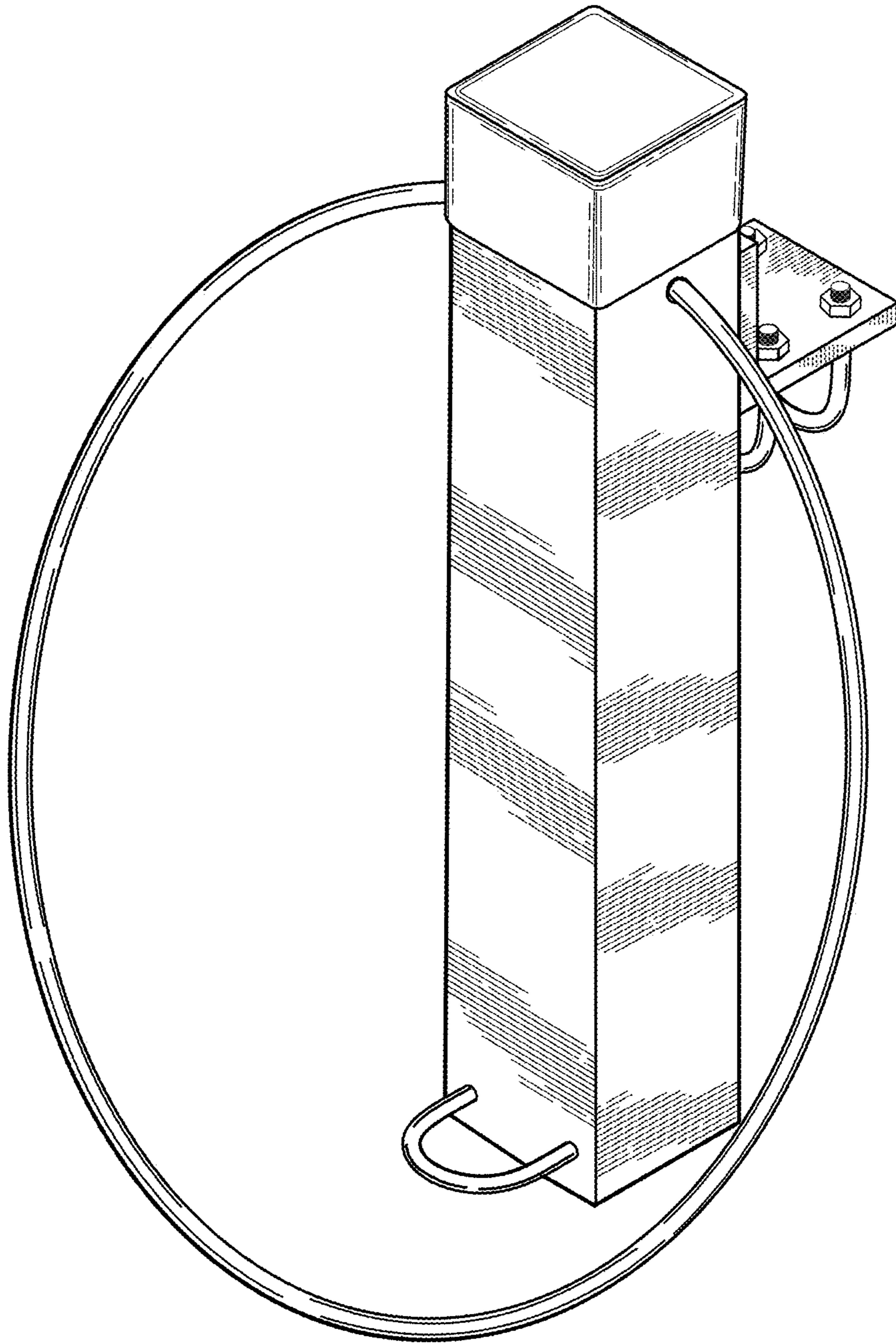

FIG. 51

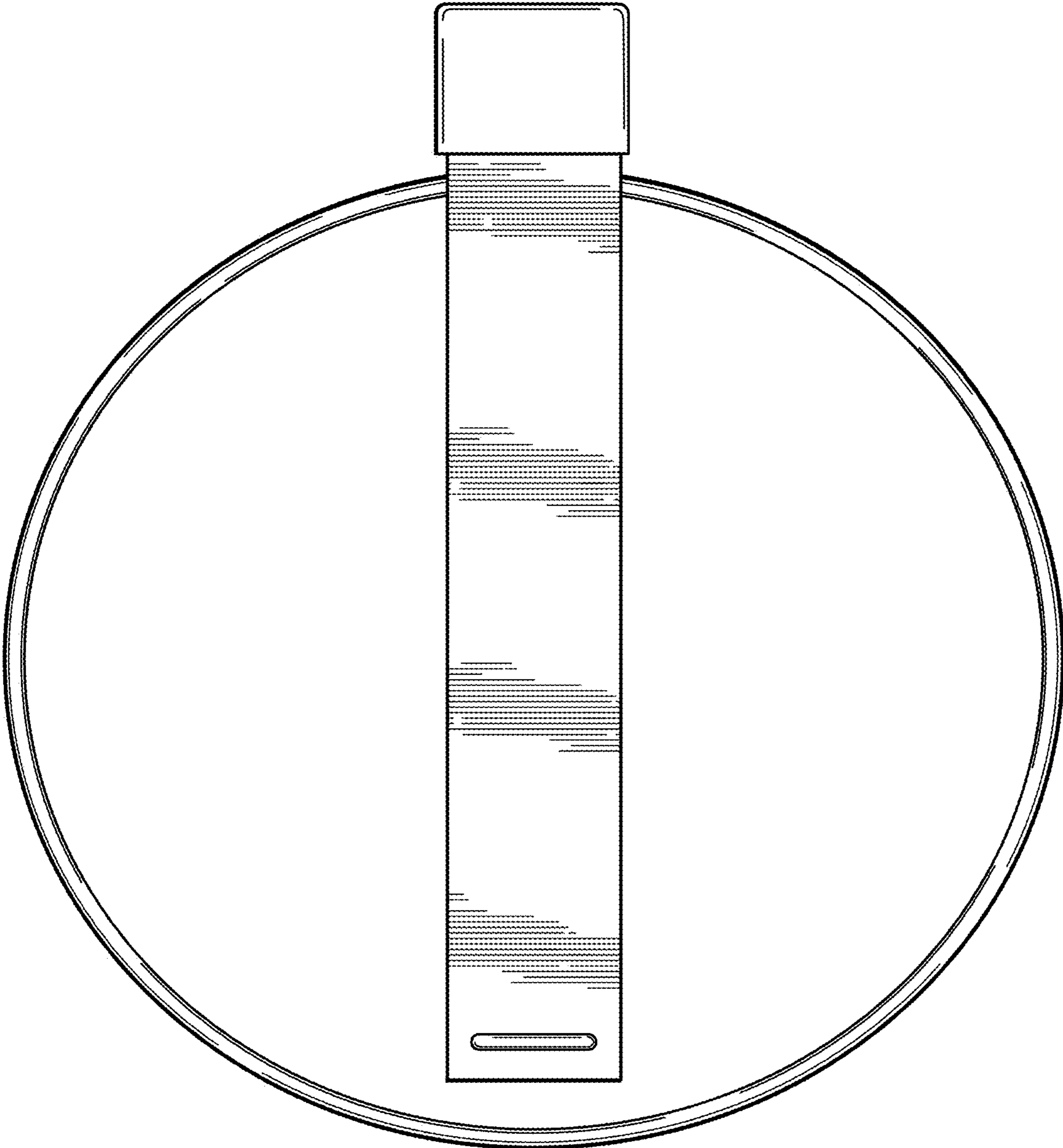

FIG. 52

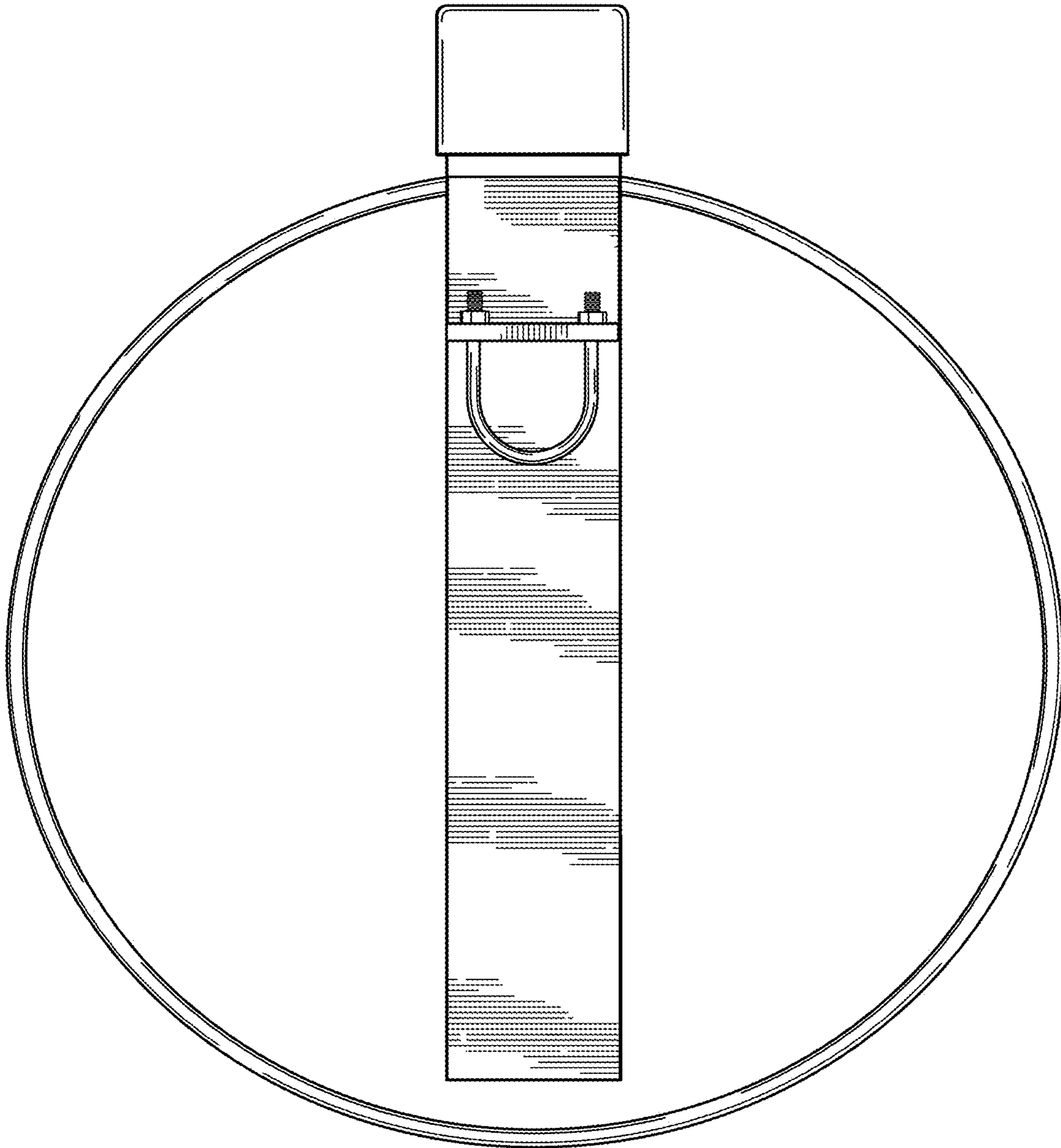

FIG. 53

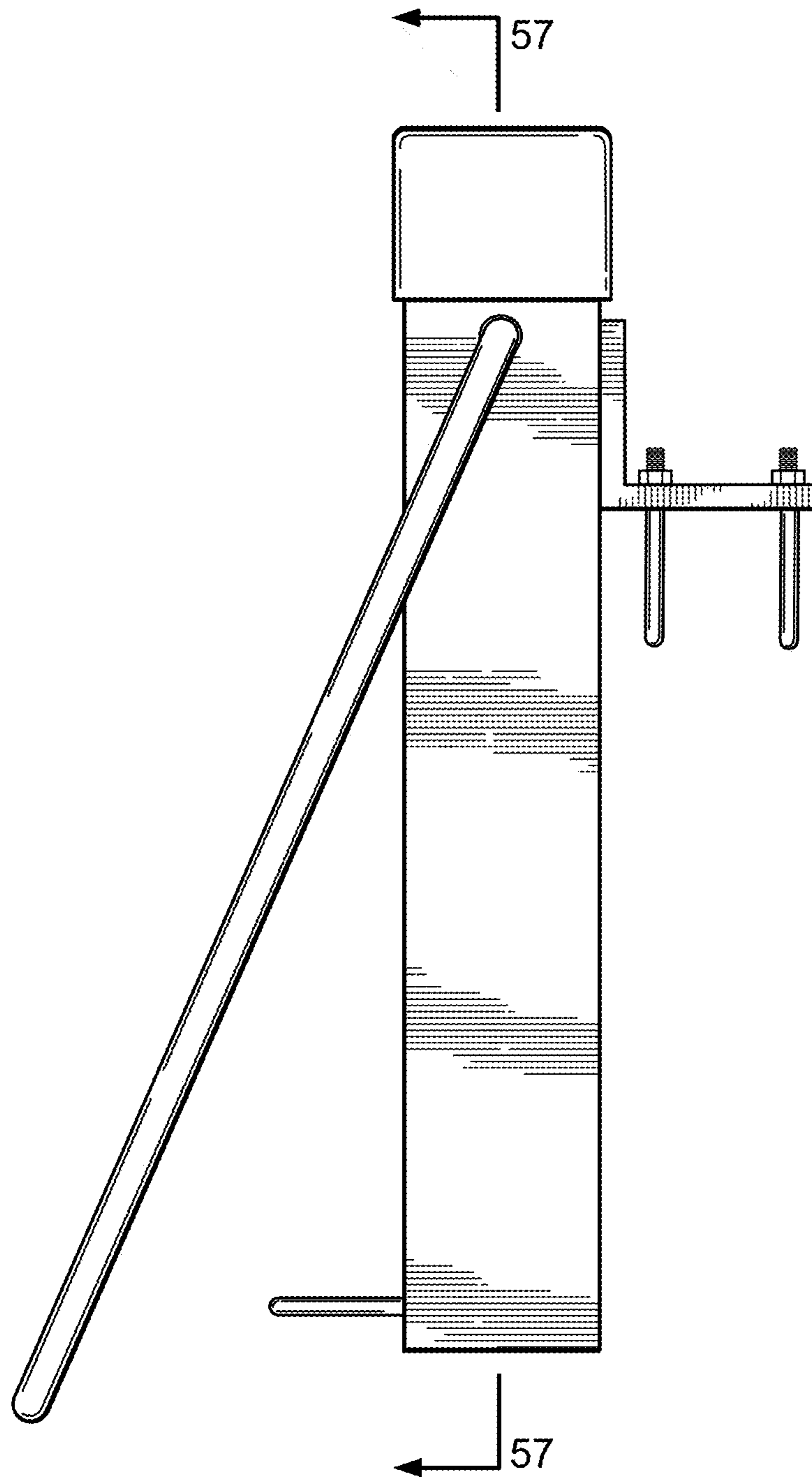

FIG. 54

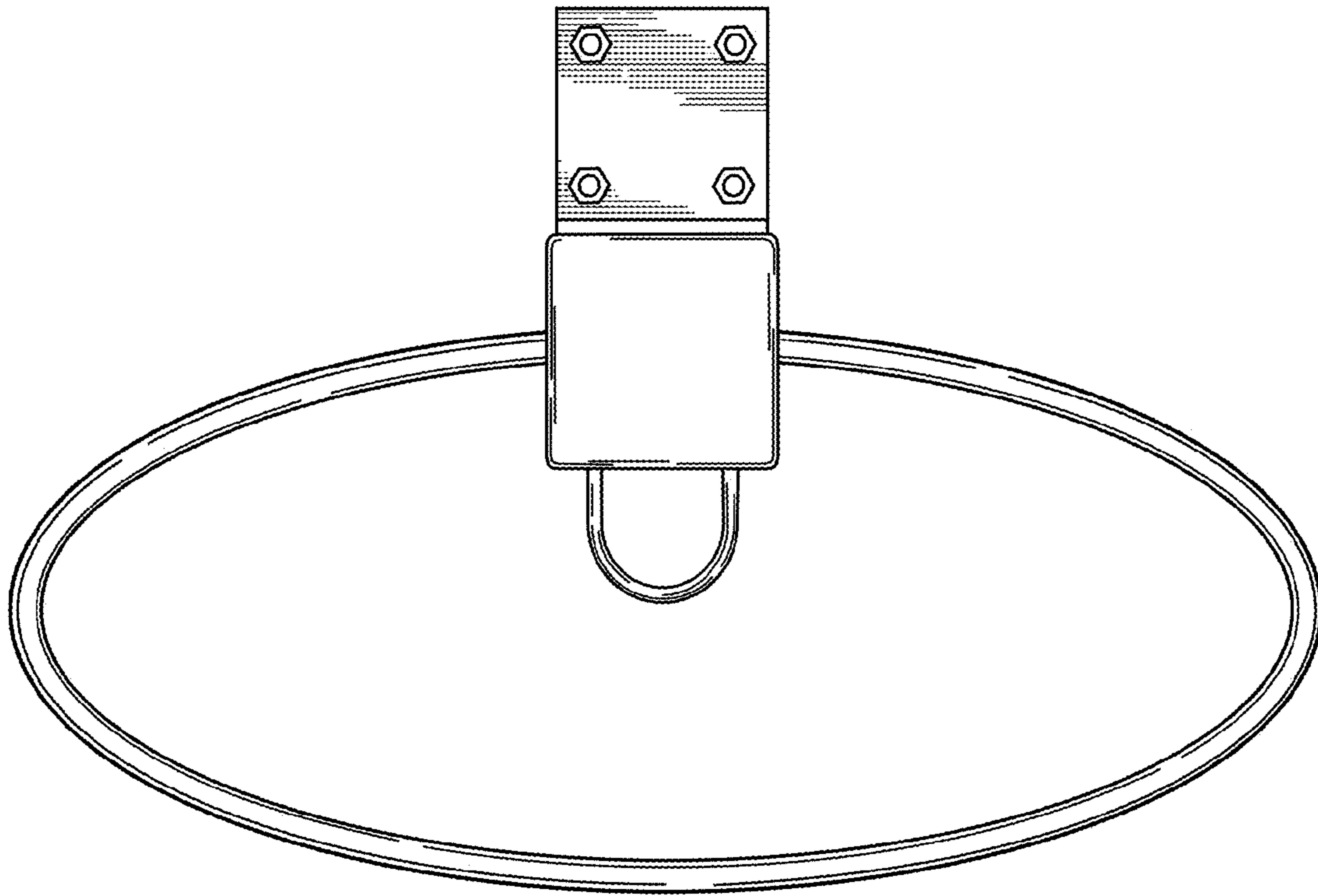

FIG. 55

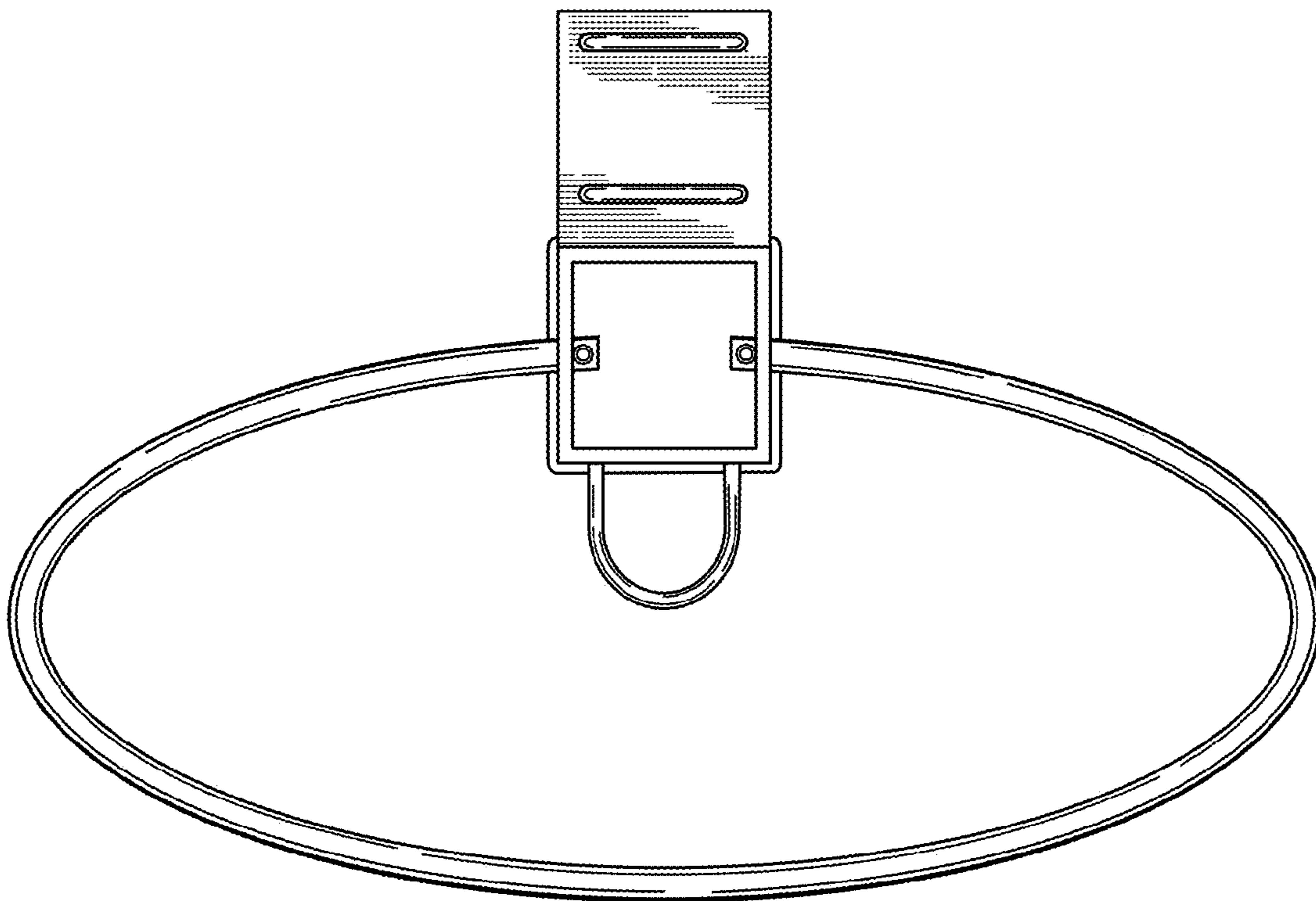

FIG. 56

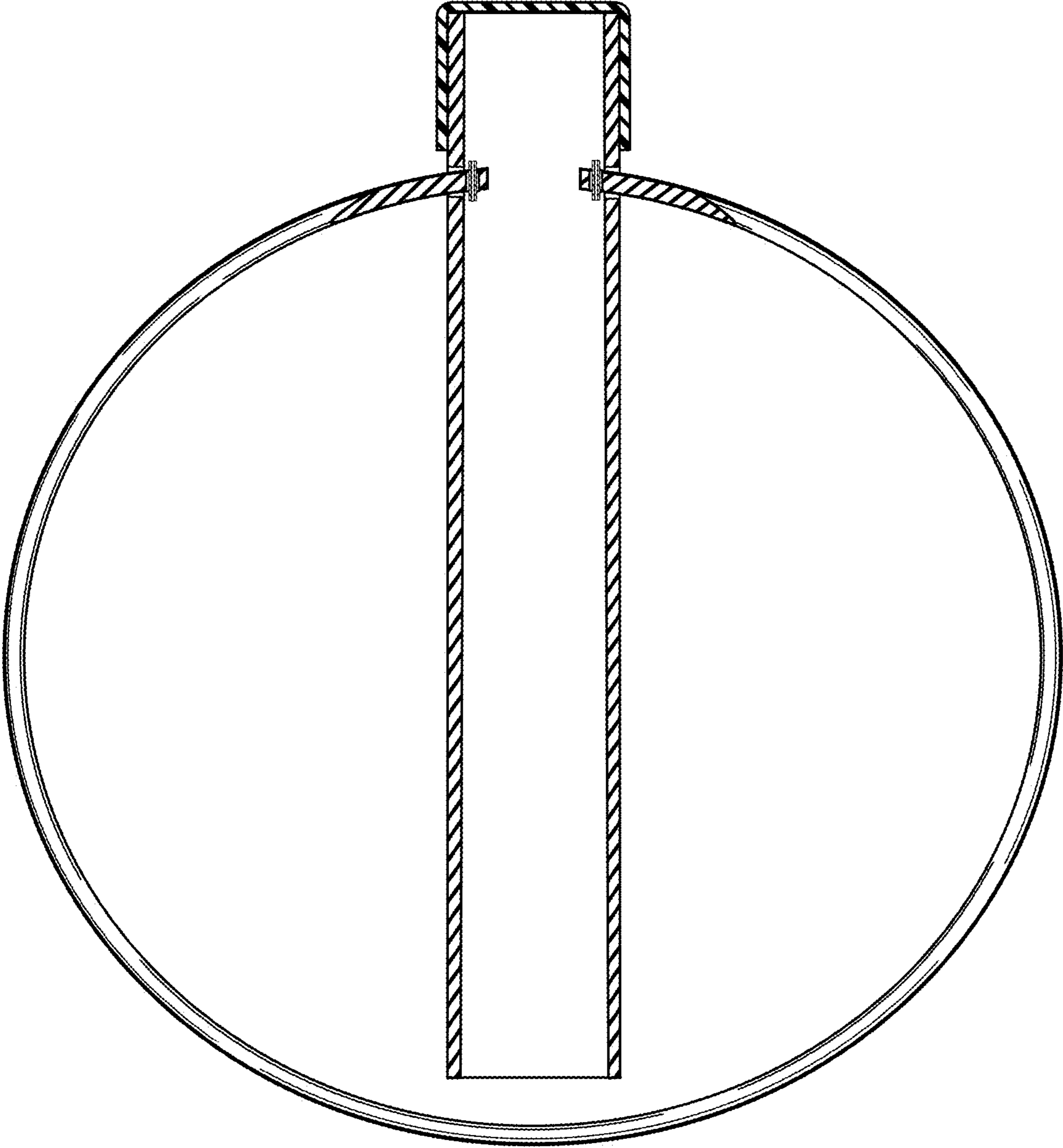

FIG. 57