



US00D953779S

(12) **United States Design Patent**
Chen

(10) **Patent No.:** **US D953,779 S**
(45) **Date of Patent:** **** Jun. 7, 2022**

(54) **TV CABINET**

D909,797 S * 2/2021 Davis D6/657
D941,064 S * 1/2022 Packer D6/657
D948,896 S * 4/2022 Chu D6/657

(71) Applicant: **JINGNING MEIGE OPERATION
MANAGEMENT CO., LTD**, Lishui
(CN)

(72) Inventor: **Fang Chen**, Cixi (CN)

(73) Assignee: **JINGNING MEIGE OPERATION
MANAGEMENT CO., LTD**, Lishui
(CN)

(**) Term: **15 Years**

(21) Appl. No.: **29/800,563**

(22) Filed: **Jul. 21, 2021**

(51) **LOC (13) Cl.** **06-04**

(52) **U.S. Cl.**
USPC **D6/657**

(58) **Field of Classification Search**
USPC D6/657, 661, 662, 662.1, 663, 664,
D6/664.1, 671, 671.1, 671.2, 671.3, 671.4
CPC A47B 96/00; A47B 96/02; A47B 47/03;
A47B 47/04; A47B 47/021; A47B
47/042; A47B 55/02; A47B 47/00; A47B
57/00; A47B 81/06; A47F 3/00
See application file for complete search history.

(56) **References Cited**

U.S. PATENT DOCUMENTS

D457,755 S 5/2002 Sun et al.
D615,776 S 5/2010 Cinna
D808,688 S * 1/2018 Everson D6/657

OTHER PUBLICATIONS

Afonso 91624 TV Stand (TV Stands—Media Consoles and Credenzas), amazon.com, Retrieved Date: Apr. 22, 2022, pp. 1-2, from <https://www.homelifefurnitureabq.com/en/product/683513-acme-furniture-afonso-91624-tv-stand> (Year: 2022).*

* cited by examiner

Primary Examiner — Mimosa De

(57) **CLAIM**

The ornamental design for a TV cabinet, as shown and described.

DESCRIPTION

FIG. 1 is a perspective view of a TV cabinet showing my new design;
FIG. 2 is another perspective view thereof;
FIG. 3 is a front elevational view thereof;
FIG. 4 is a rear elevational view thereof;
FIG. 5 is a left side elevational view thereof;
FIG. 6 is a right side elevational view thereof;
FIG. 7 is a top plan view thereof;
FIG. 8 is a bottom plan view thereof; and,
FIG. 9 is an enlarged view of portion 9 shown in FIG. 1.
The dash-dash broken lines in the drawings depict portions of the TV cabinet that form no part of the claimed design. The dot-dash broken lines represent boundaries of the enlarged portion and form no part of the claimed design.

1 Claim, 9 Drawing Sheets

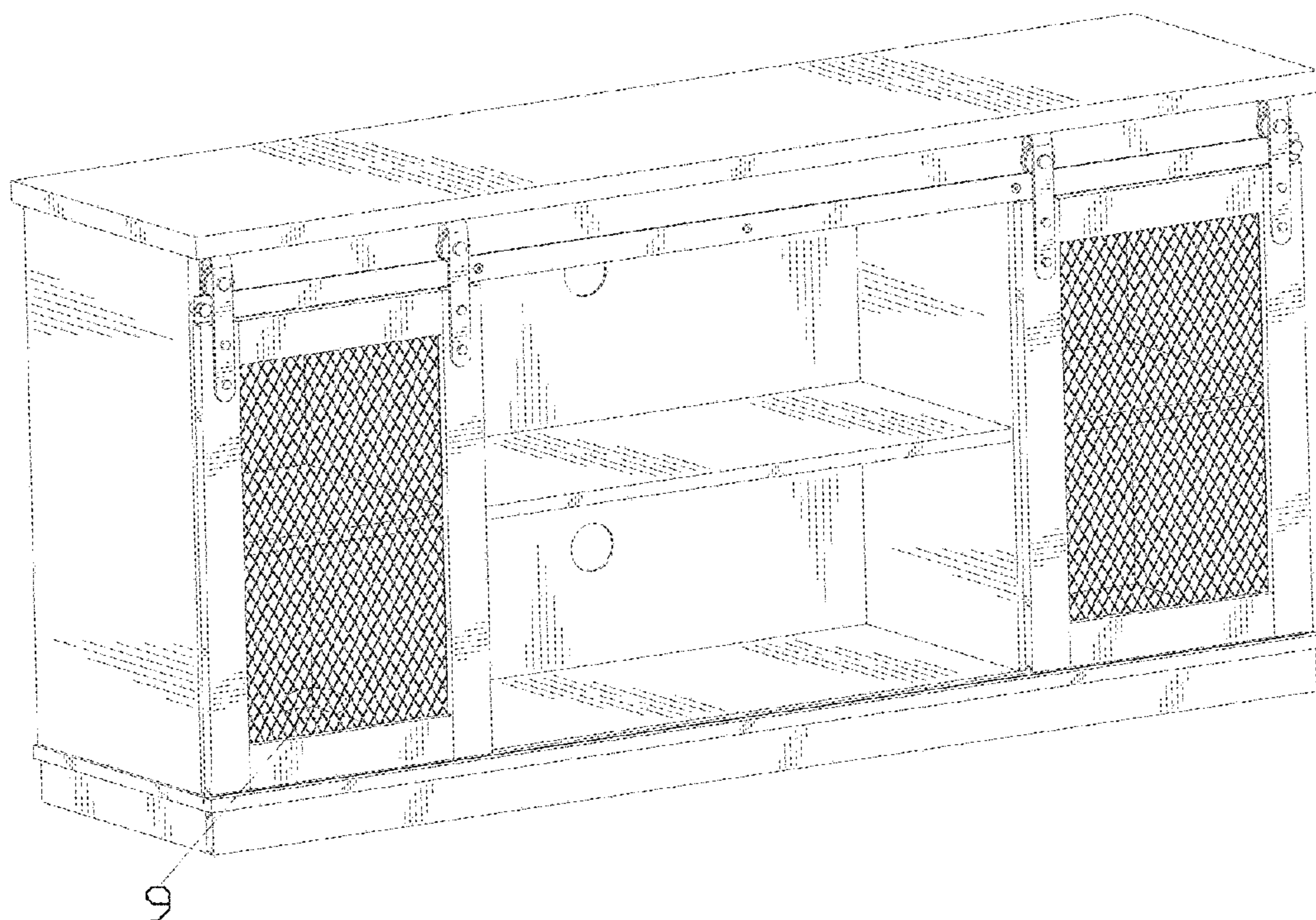

9

FIG. 1

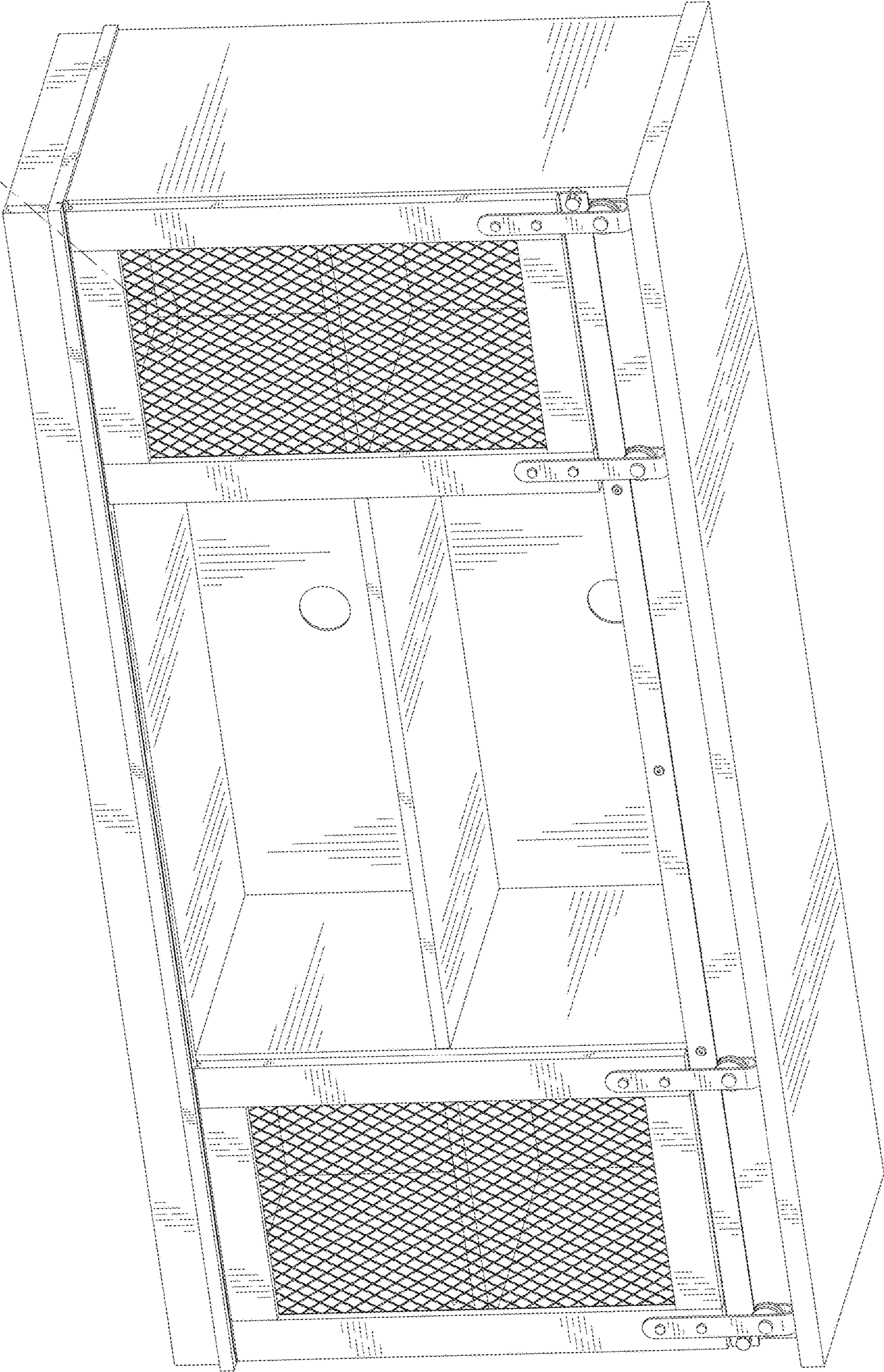

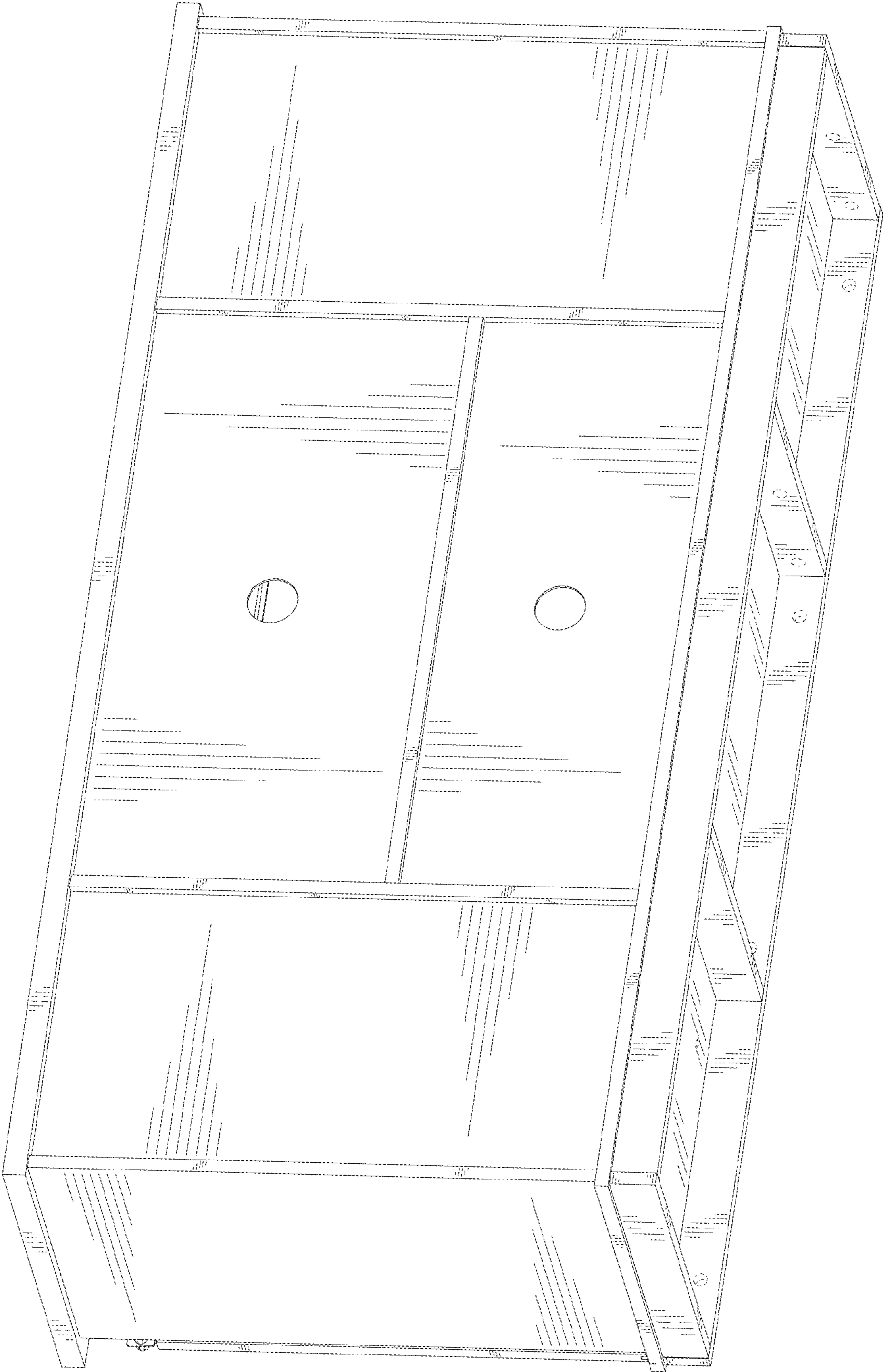

FIG. 2

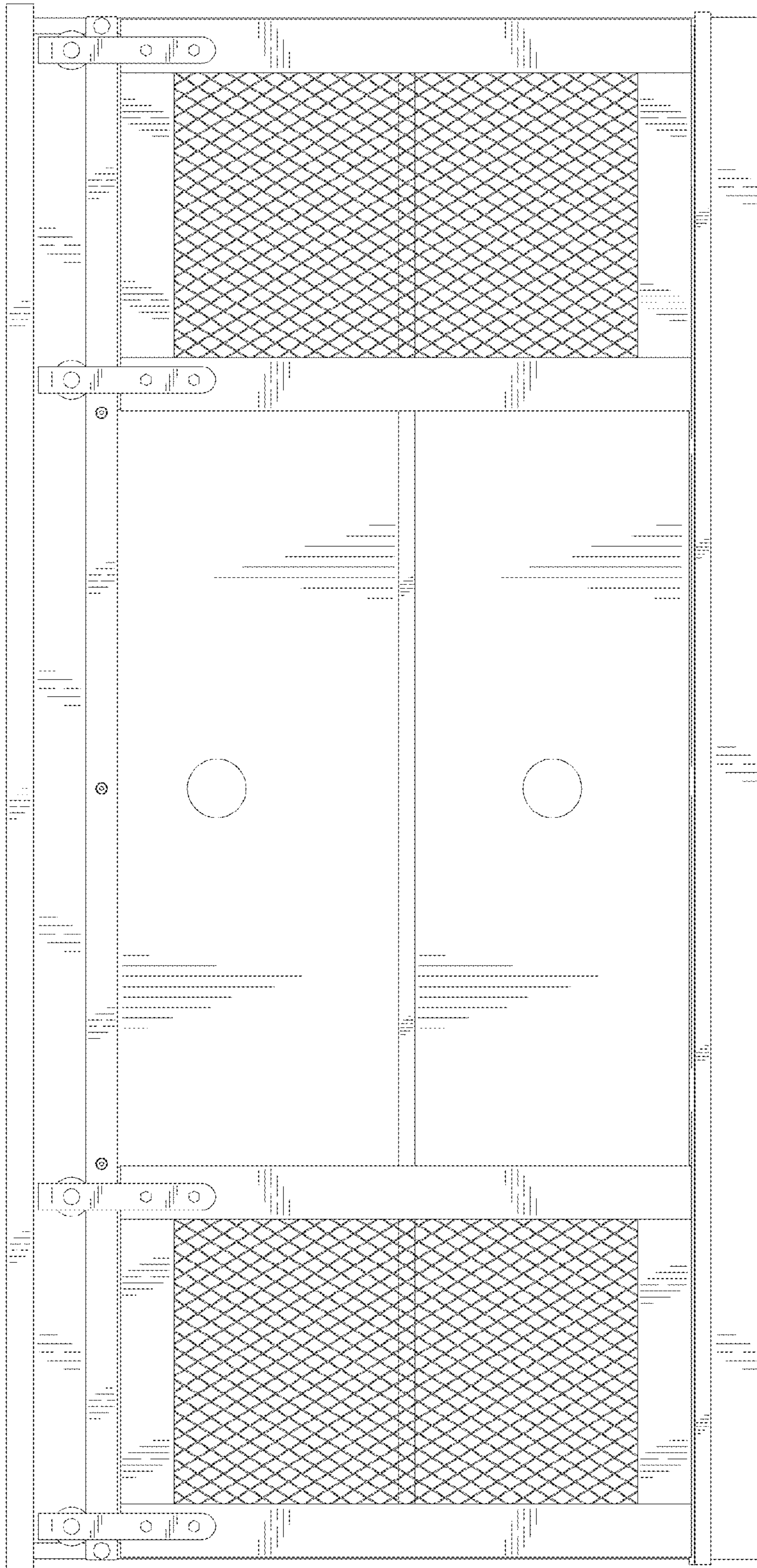

FIG. 3

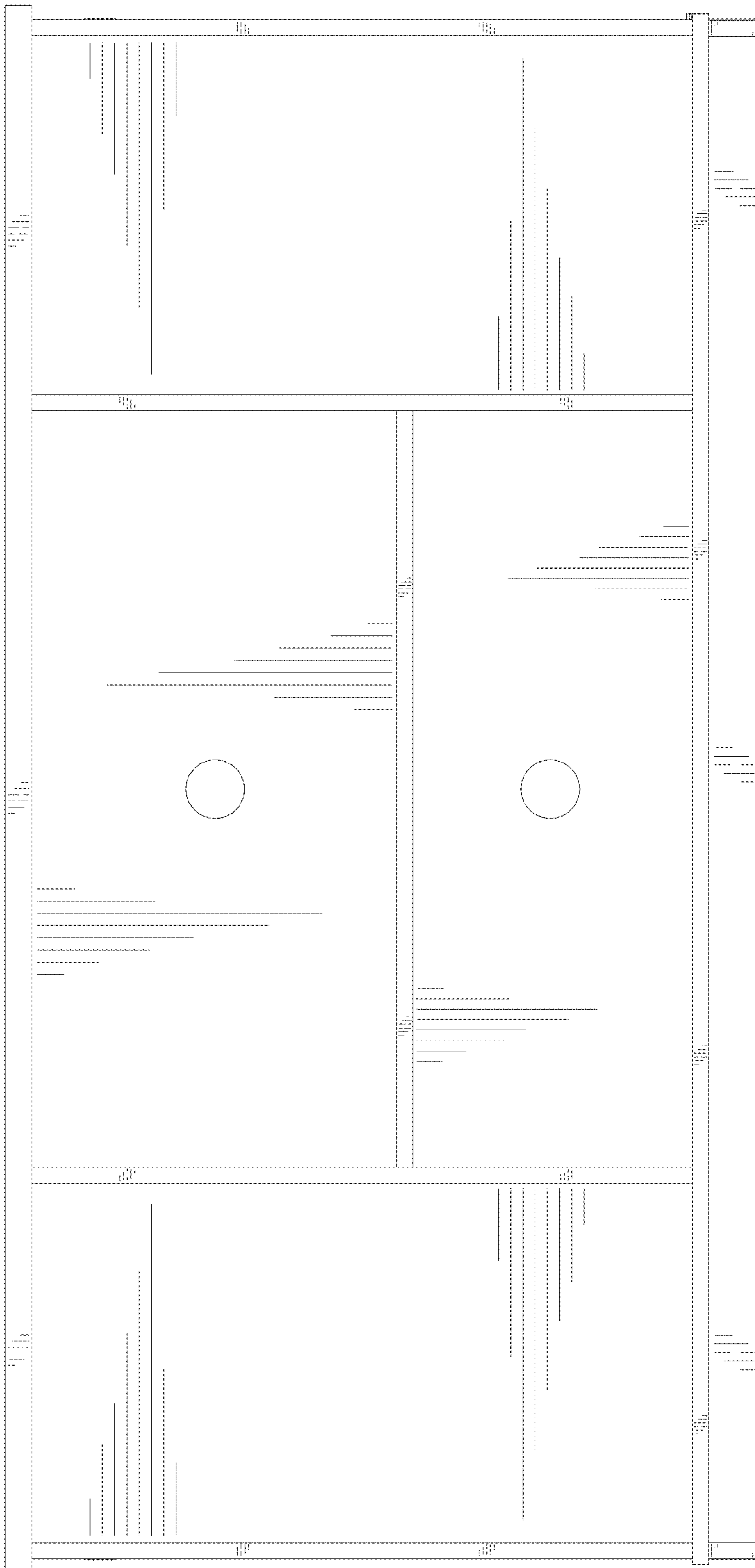

FIG. 4

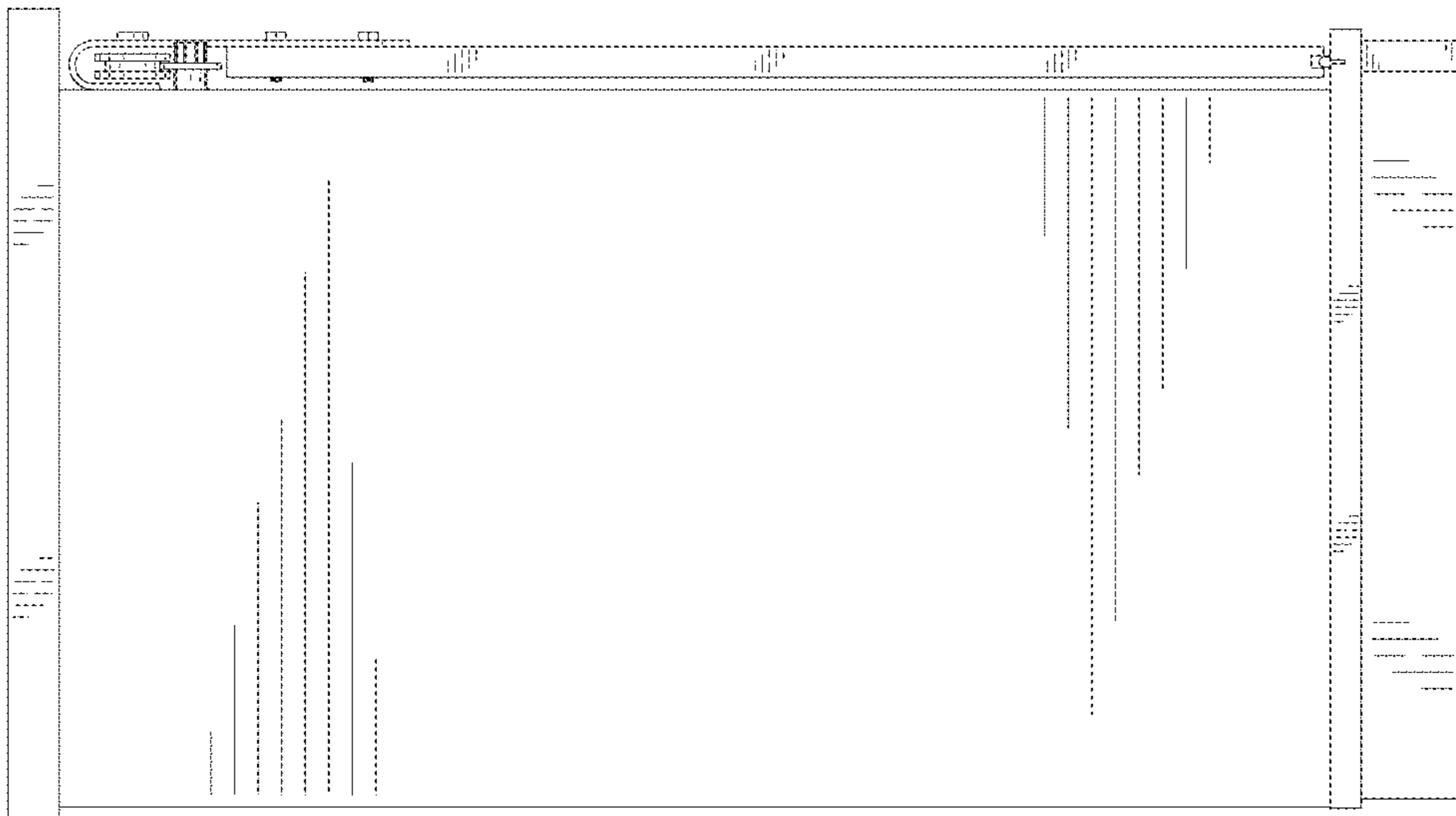

FIG. 5

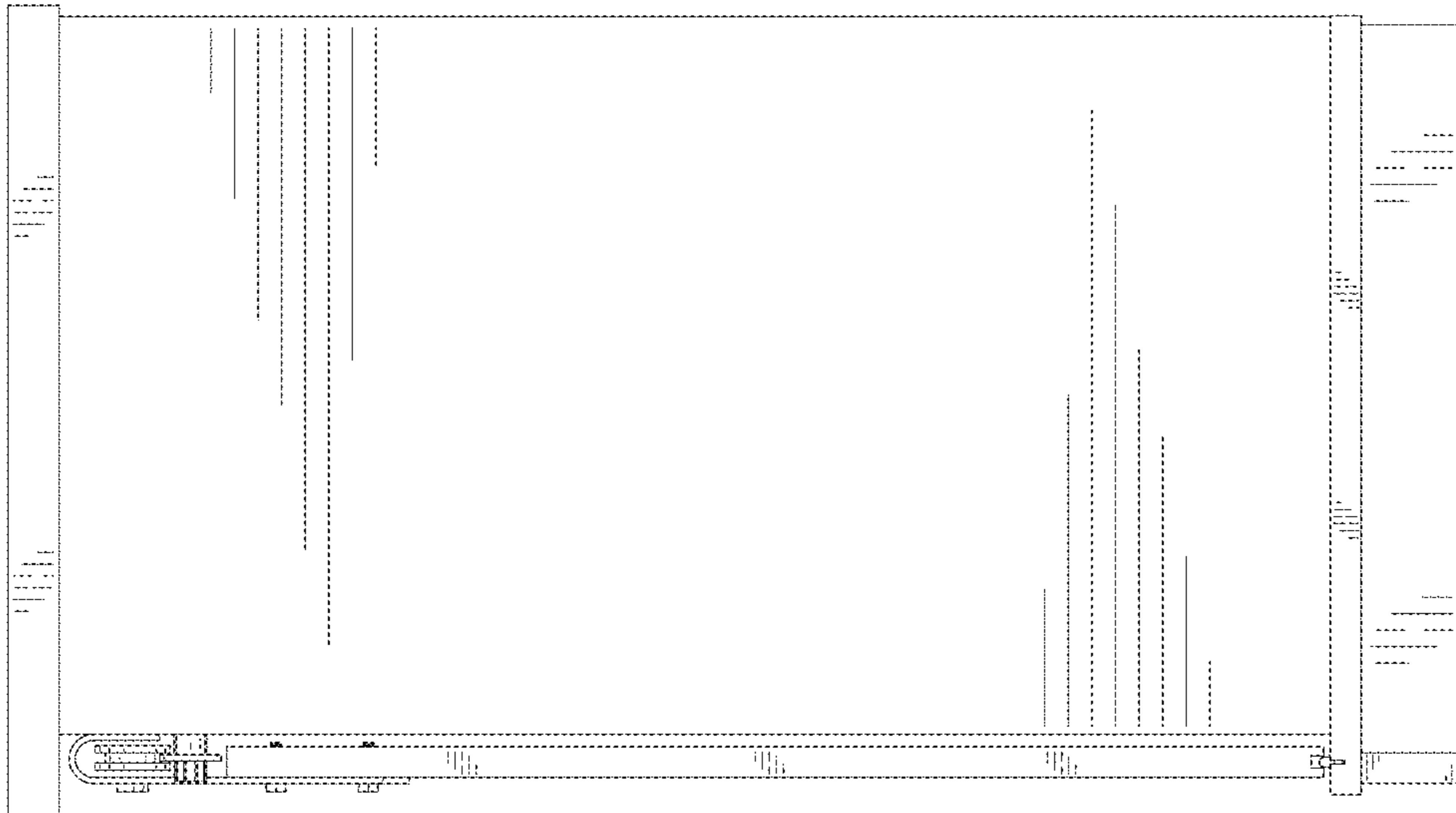

FIG. 6

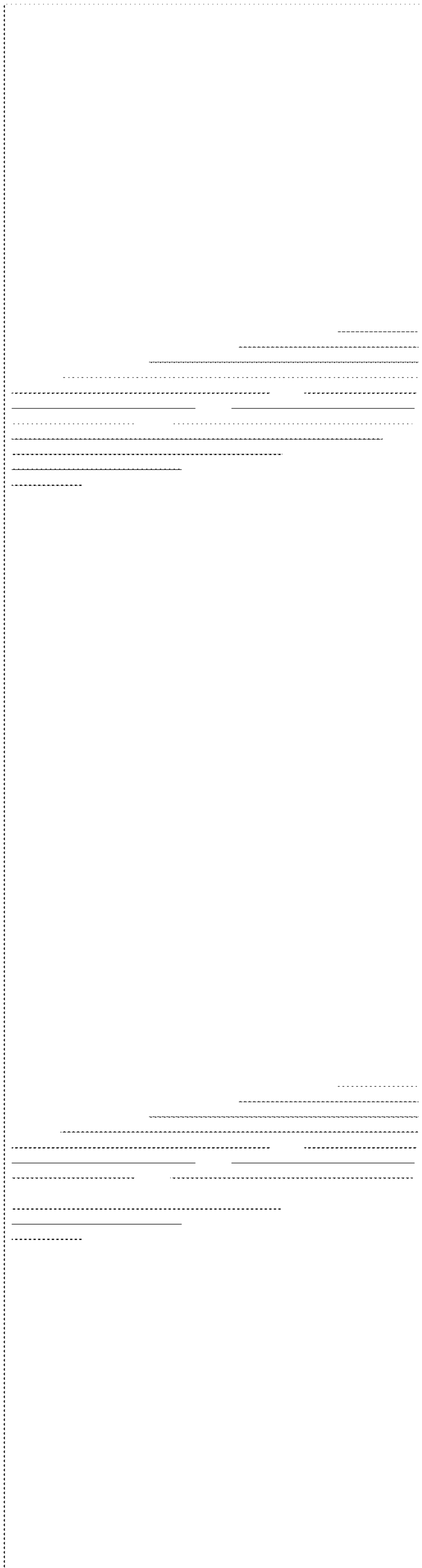

FIG. 7

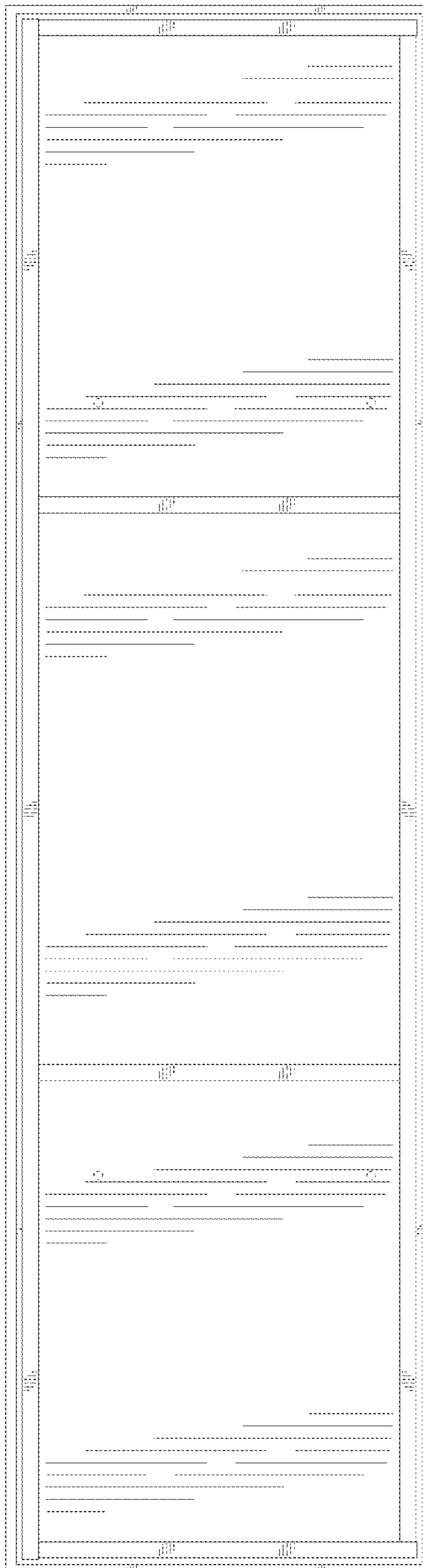

FIG. 8

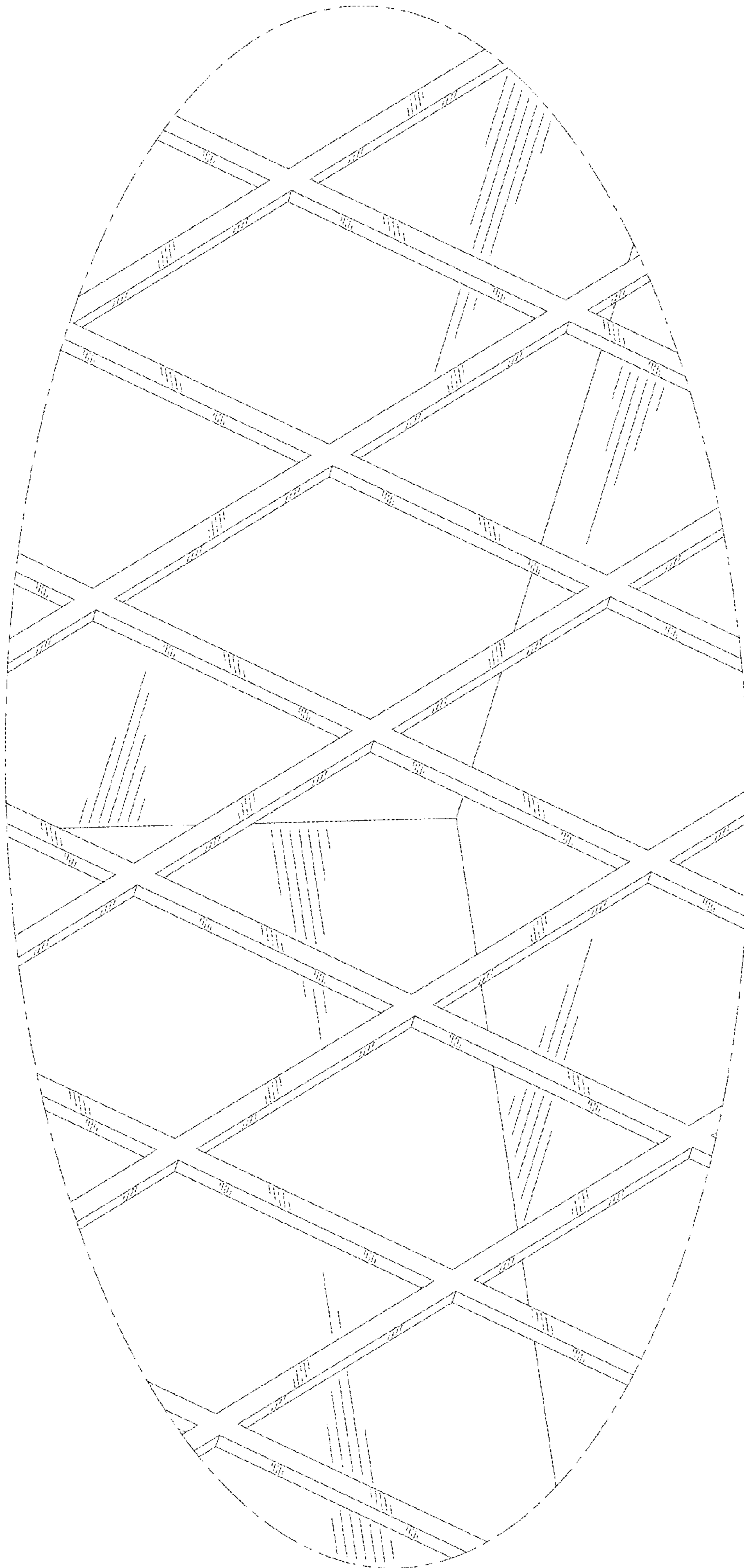

FIG. 9