



US00D953745S

(12) **United States Design Patent** (10) **Patent No.:** **US D953,745 S**
Vella et al. (45) **Date of Patent:** **** Jun. 7, 2022**

(54) **TOOTHBRUSH HEAD**
(71) Applicant: **Goodwell Inc.**, Portland, OR (US)
(72) Inventors: **Ethan E. Vella**, Portland, OR (US);
Chase T. Thompson, Portland, OR (US); **Patrick R. Triato**, Portland, OR (US)
(73) Assignee: **Goodwell Inc.**, Portland, OR (US)
(**) Term: **15 Years**
(21) Appl. No.: **29/702,748**
(22) Filed: **Aug. 21, 2019**

Related U.S. Application Data

(63) Continuation-in-part of application No. 16/361,145, filed on Mar. 21, 2019, now abandoned, which is a continuation-in-part of application No. PCT/US2018/050386, filed on Sep. 11, 2018, said application No. PCT/US2018/050386 is a continuation of application No. 16/107,020, filed on Aug. 21, 2018.

Foreign Application Priority Data

(30) Feb. 21, 2019 (WO) DM/201396
(51) **LOC (13) Cl.** **28-03**
(52) **U.S. Cl.**
USPC **D4/101**
(58) **Field of Classification Search**
USPC D4/100, 101, 104, 105, 106, 108, 107,
D4/109, 110, 111, 112, 113, 114, 116,
D4/121, 127, 129, 130, 138, 199;
D30/158, 159
CPC A46B 9/04; A46B 5/02; A46B 2200/1066;
A46B 2200/1073; A46B 2200/1086
See application file for complete search history.

(56) **References Cited**
U.S. PATENT DOCUMENTS
D270,307 S * 8/1983 Hollingshead D4/110
D420,804 S * 2/2000 Juhlin D4/104
6,966,093 B2 * 11/2005 Eliav A46B 15/0032
15/110
D579,664 S * 11/2008 Fisher D4/101
8,302,238 B2 * 11/2012 Biro A61C 17/349
15/22.1
D689,698 S * 9/2013 Dickie D4/101
(Continued)

OTHER PUBLICATIONS

The Proctor & Gamble Co., "Complete Battery Replacement Brush Heads", <https://oralb.com/en-us/products/toothbrushes/battery-toothbrushes/complete-battery-replacement-brush-heads/>, visited Apr. 14, 2021, 3 pages.
(Continued)

Primary Examiner — Karen E Eldridge Powers
(74) *Attorney, Agent, or Firm* — Stoel Rives LLP

(57) **CLAIM**
We claim the ornamental design for a toothbrush head, as shown and described.

DESCRIPTION

FIG. 1 is a top, front and left-side isometric view of a toothbrush head, according to an embodiment of our new design.
FIG. 2 is a front elevation view thereof.
FIG. 3 is a back elevation view thereof.
FIG. 4 is a top plan view thereof.
FIG. 5 is a bottom plan view thereof.
FIG. 6 is a left side elevation view thereof; and,
FIG. 7 is a right side elevation view thereof.
In the drawings, the broken lines are for the purpose of illustrating the environment of the design embodiment and form no part of the claimed design.

1 Claim, 6 Drawing Sheets

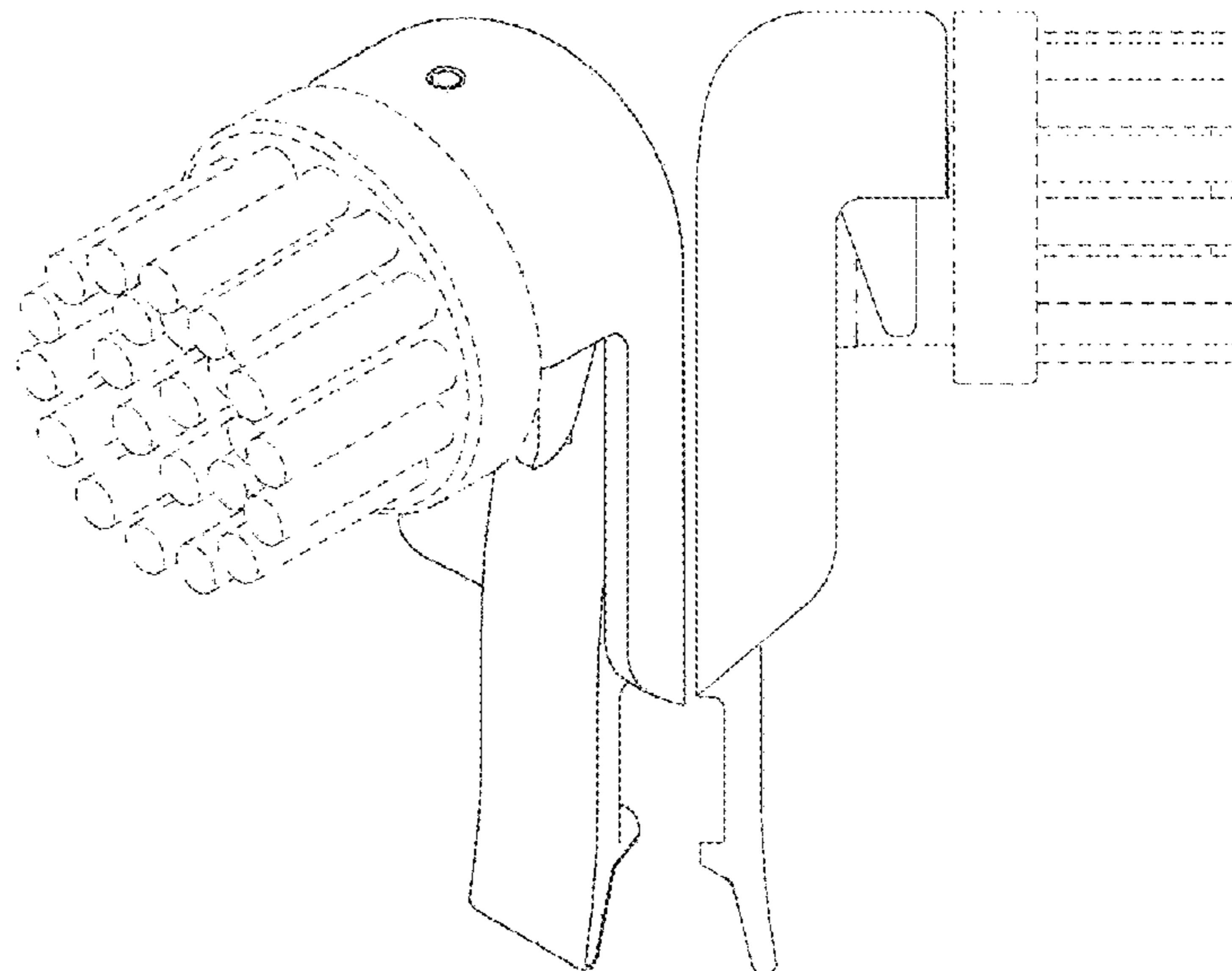

(56)

References Cited

U.S. PATENT DOCUMENTS

D706,033 S * 6/2014 Dickie D4/101
D749,852 S * 2/2016 Since D4/101
D751,821 S * 3/2016 Since D4/101
9,332,828 B2 * 5/2016 Dickie A61C 17/222
D853,732 S * 7/2019 Wainless D4/104
D868,476 S * 12/2019 Papazian D4/101
2019/0083217 A1 * 3/2019 Triato F16D 7/044
2020/0085552 A1 * 3/2020 Triato A46B 13/08
2020/0315758 A1 * 10/2020 Papazian A46B 7/042
2021/0186414 A1 * 6/2021 Gatzemeyer A61B 5/0088

OTHER PUBLICATIONS

The Proctor & Gamble Company, "Oral-B Complete Battery Replacement Brush Heads", archived at <https://web.archive.org/web/20170710104232/https://oralb.com/en-us/products/complete-battery-replacement-brush-heads>, archived Jul. 10, 2017, 4 pages.

The Proctor & Gamble Co., "Oral-B Complete Action Power Genuine Oral-B Brush Heads", <https://ob.factoryoutletstore.com/details/2373/oral-b-complete-action-power-soft-brushhead-2-pack.html>, visited Apr. 14, 2021.

Oral-B India, "How to replace brush head of Oral-B Cross Action Power", <https://www.youtube.com/watch?v=YCJosxLi8AM>, Mar. 2, 2016, entire video.

* cited by examiner

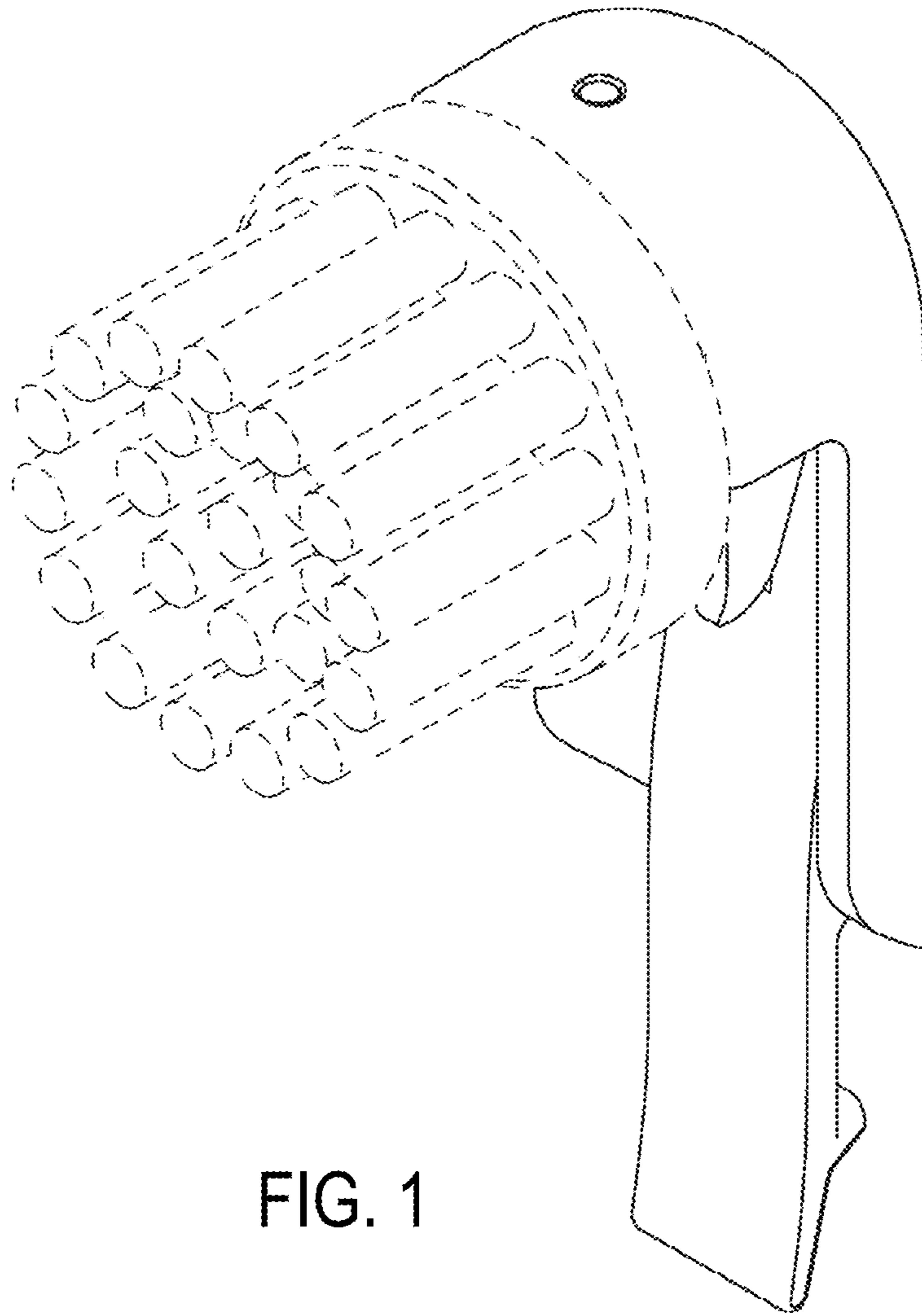

FIG. 1

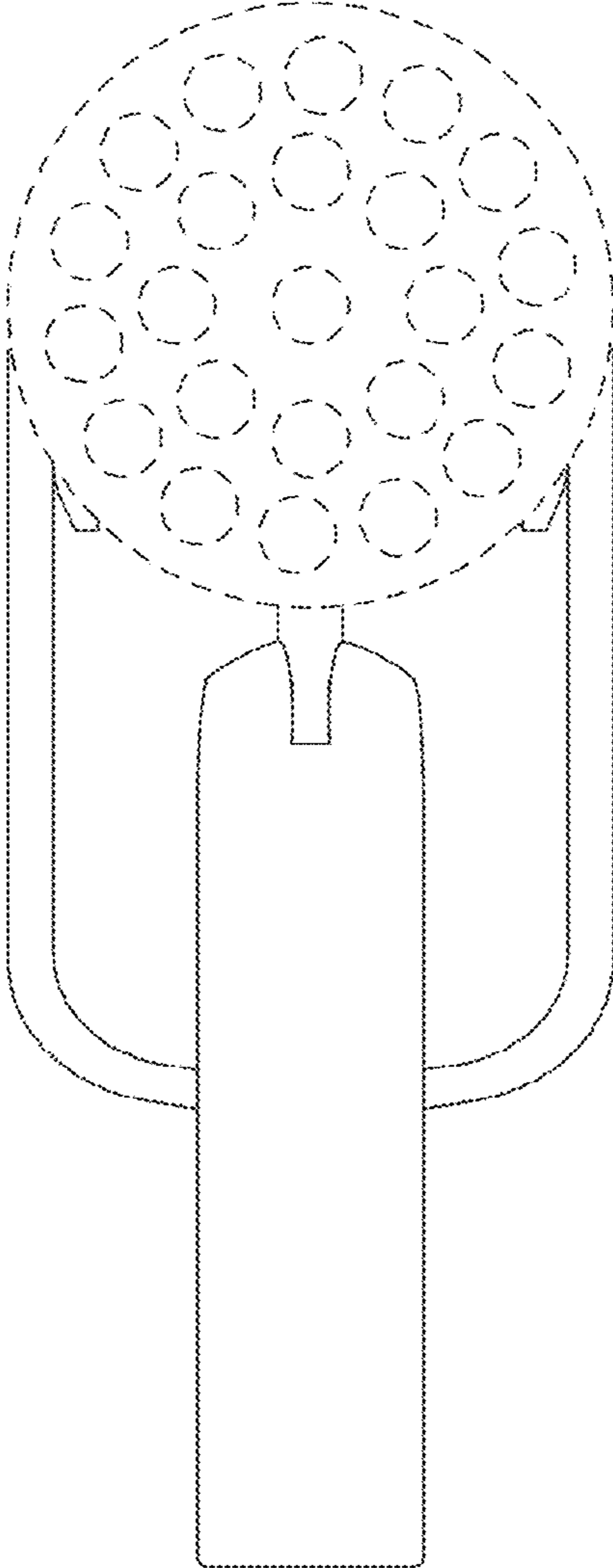

FIG. 2

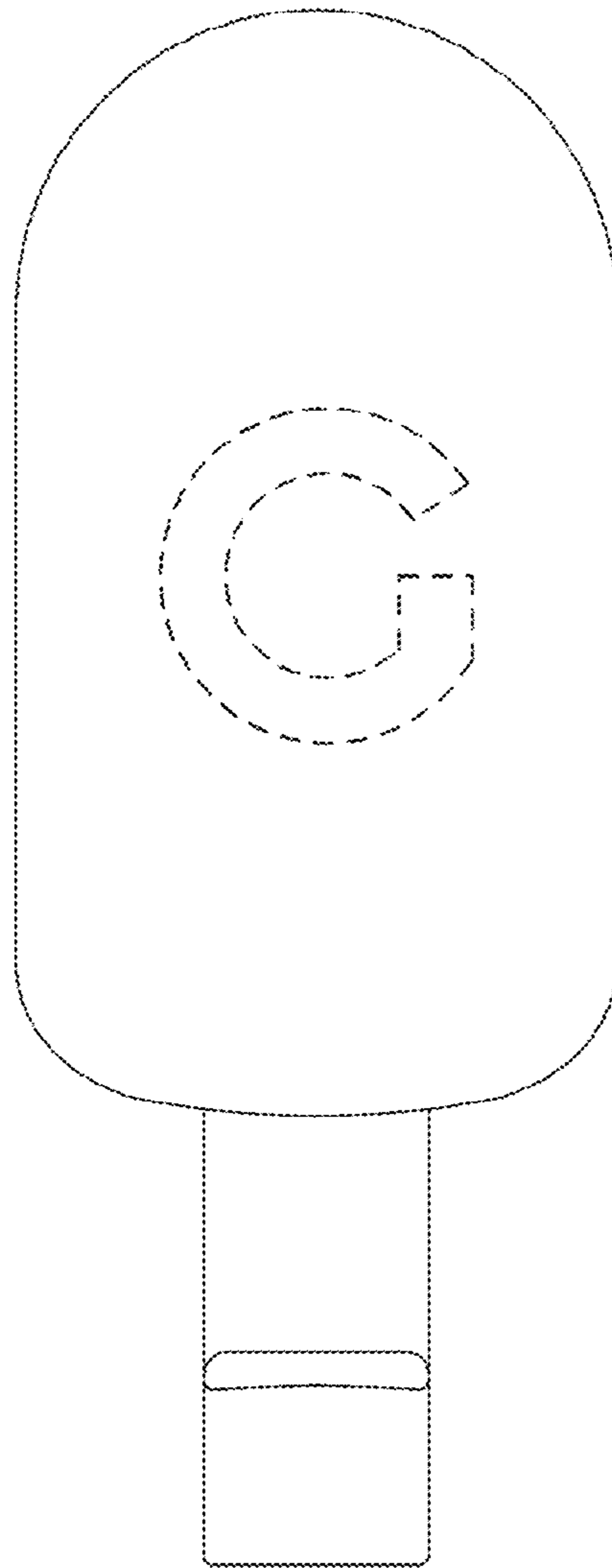

FIG. 3

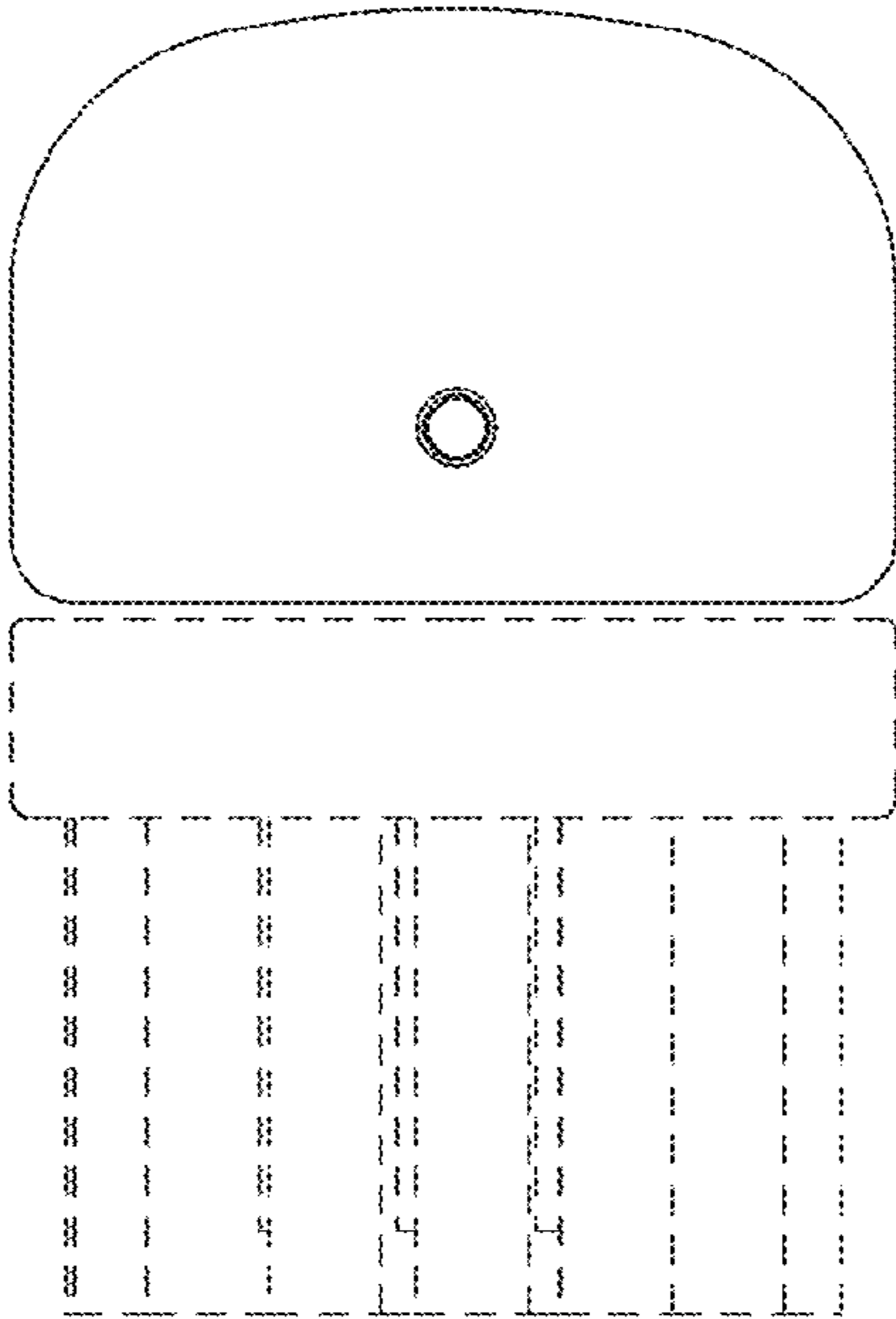

FIG. 4

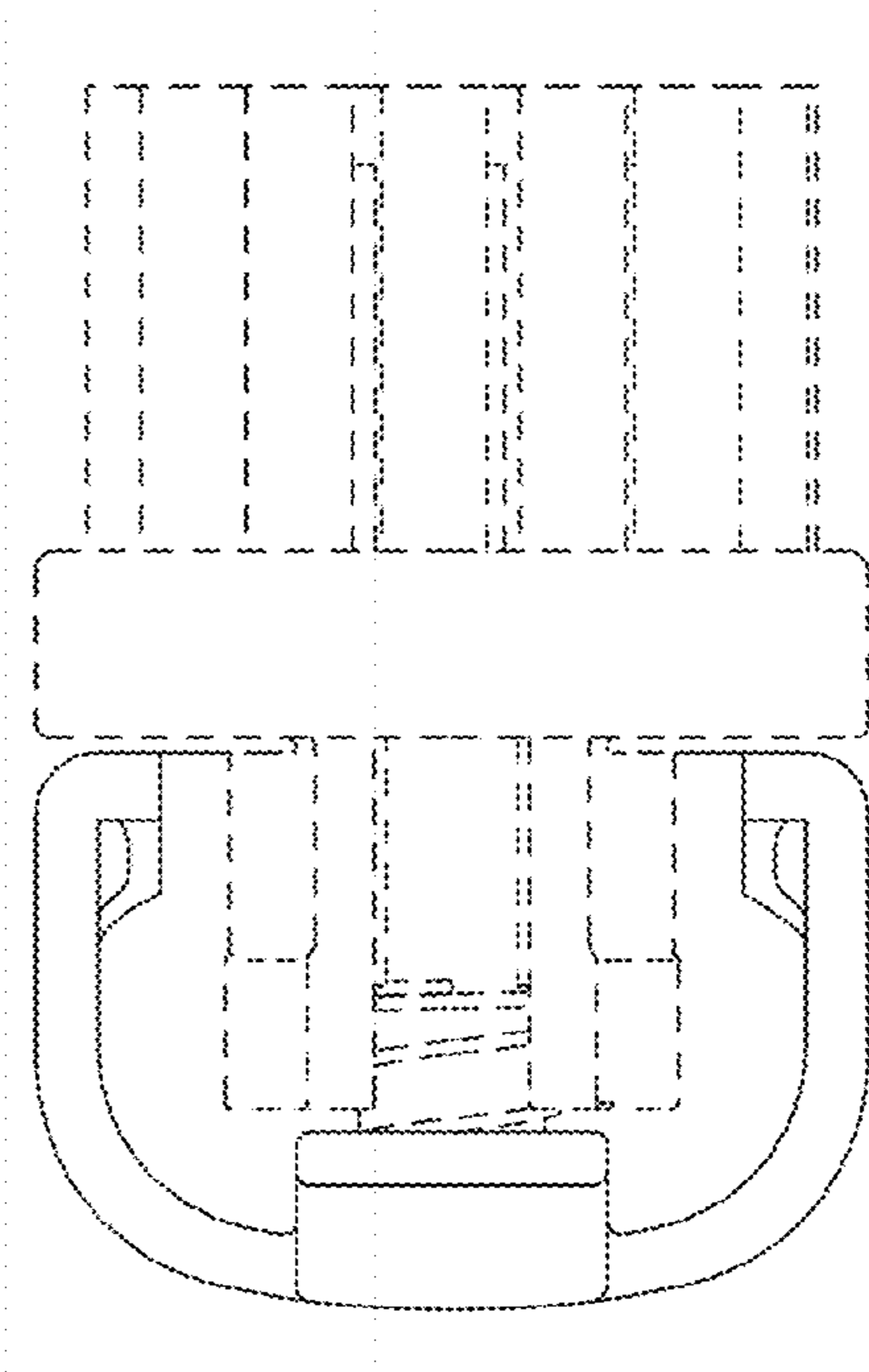
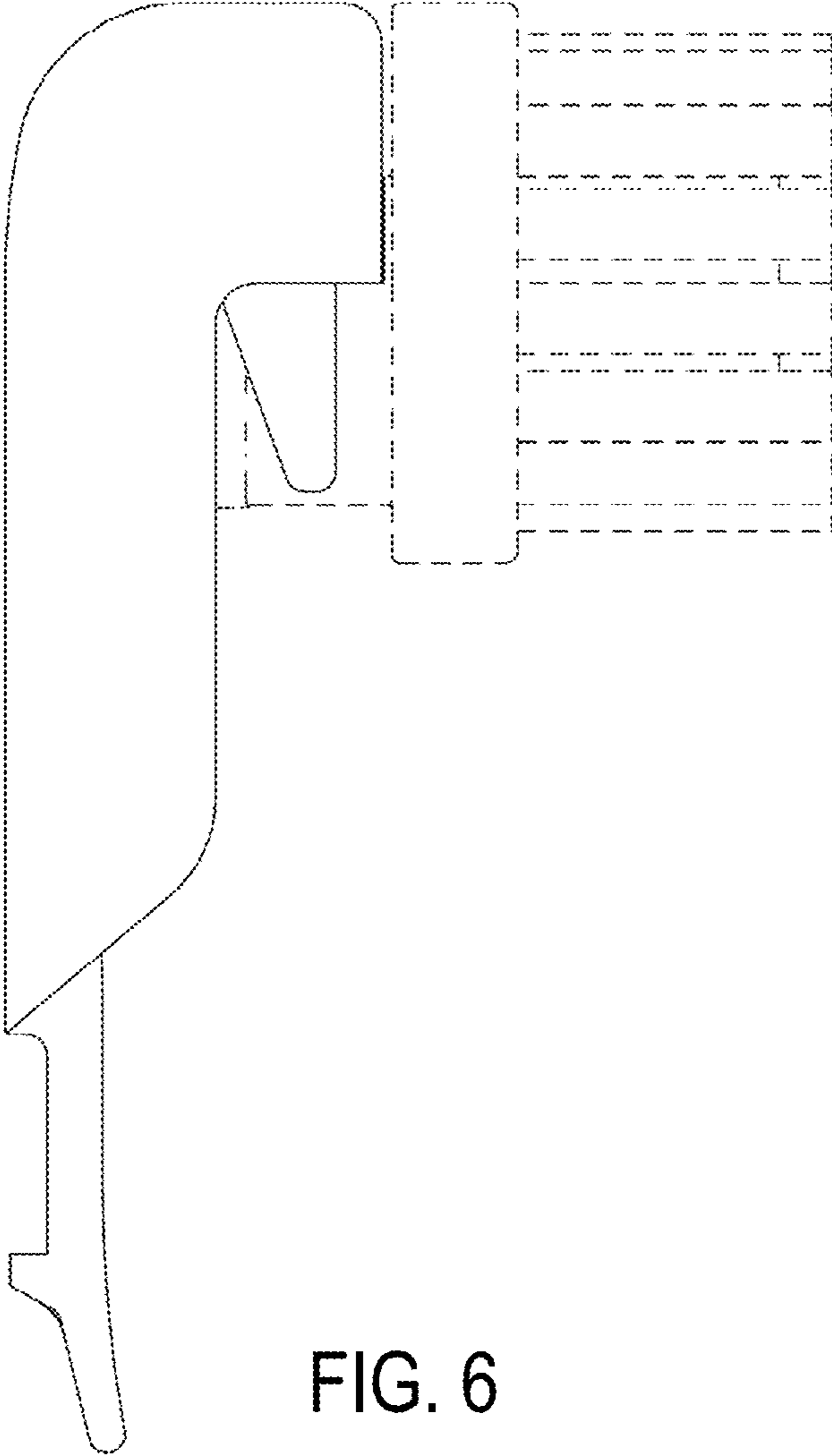

FIG. 5



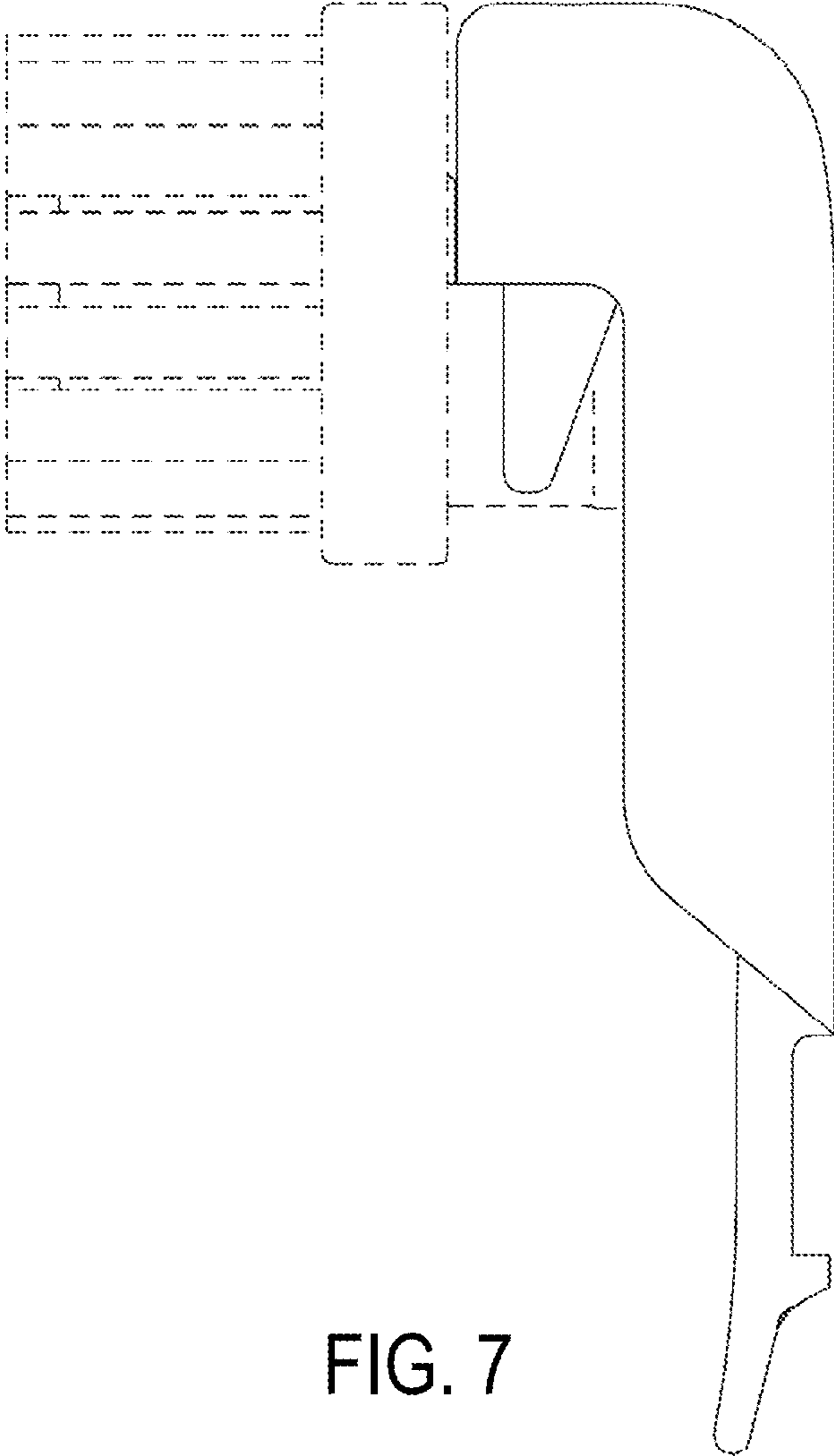

FIG. 7