



US00D953708S

(12) **United States Design Patent**
Gorden

(10) **Patent No.:** **US D953,708 S**
(45) **Date of Patent:** **** Jun. 7, 2022**

(54) **CONVERTIBLE HEEL WITH A
DETACHABLE LEG COVER**

(74) *Attorney, Agent, or Firm* — Bradley Arant Boult
Cummings LLP

(71) Applicant: **B. Cattini Shoes, LLC**, Miami Beach,
FL (US)

(57) **CLAIM**

The ornamental design for a convertible heel with a detach-
able leg cover, as shown and described.

(72) Inventor: **Josephine Gorden**, Pike Road, AL
(US)

DESCRIPTION

(73) Assignee: **B. Cattini Shoes, LLC**, Miami Beach,
FL (US)

FIG. 1 is a front perspective view of a convertible heel with
a detachable leg cover.

(**) Term: **15 Years**

FIG. 2 is a first side view of the convertible heel with a
detachable leg cover of FIG. 1.

(21) Appl. No.: **29/743,150**

FIG. 3 is a second side view of the convertible heel with a
detachable leg cover of FIG. 1.

(22) Filed: **Jul. 20, 2020**

FIG. 4 is a back view of the convertible heel with a
detachable leg cover of FIG. 1.

(51) **LOC (13) Cl.** **02-04**

FIG. 5 is a front view of the convertible heel with a
detachable leg cover of FIG. 1.

(52) **U.S. Cl.**
USPC **D2/939**; D2/909; D2/925; D2/966;
D2/901

FIG. 6 is a top view of the convertible heel with a detachable
leg cover of FIG. 1.

(58) **Field of Classification Search**
USPC D2/896, 900–902, 904, 906–912,
D2/916–924, 925–945, 969, 970–979;
(Continued)

FIG. 7 is a bottom view of the convertible heel with a
detachable leg cover of FIG. 1.

(56) **References Cited**

FIG. 8 is a back view of the convertible heel with a
detachable leg cover of FIG. 1 showing the detachable leg
cover unzipped.

U.S. PATENT DOCUMENTS

258,996 A * 6/1882 Cory A41D 17/00
36/2 R
2,438,308 A * 3/1948 Wheaton A41D 17/00
36/2 R

FIG. 9 is a front view of the convertible heel with a
detachable leg cover of FIG. 1 showing the detachable leg
cover unzipped.

(Continued)

OTHER PUBLICATIONS

Ride or Die Dark Blue Denim Detachable Leg Boots, Simmi.com,
[online], [site visited Sep. 29, 2021]. <URL: <https://www.simmi.com/us/clermont-twins-ride-or-die-dark-blue-denim-detachable-leg-boots>> (Year: 2021).*

FIG. 10 is a back view of the convertible heel with a
detachable leg cover of FIG. 1 showing the detachable leg
cover opened.

(Continued)

FIG. 11 is a front view of the convertible heel with a
detachable leg cover of FIG. 1 showing the detachable leg
cover opened.

Primary Examiner — Jonathan J Han

FIG. 12 is an exploded front perspective view of the
convertible heel with a detachable leg cover of FIG. 1.

(Continued)

FIG. 13 is an exploded first side view of the convertible heel
with a detachable leg cover of FIG. 1.

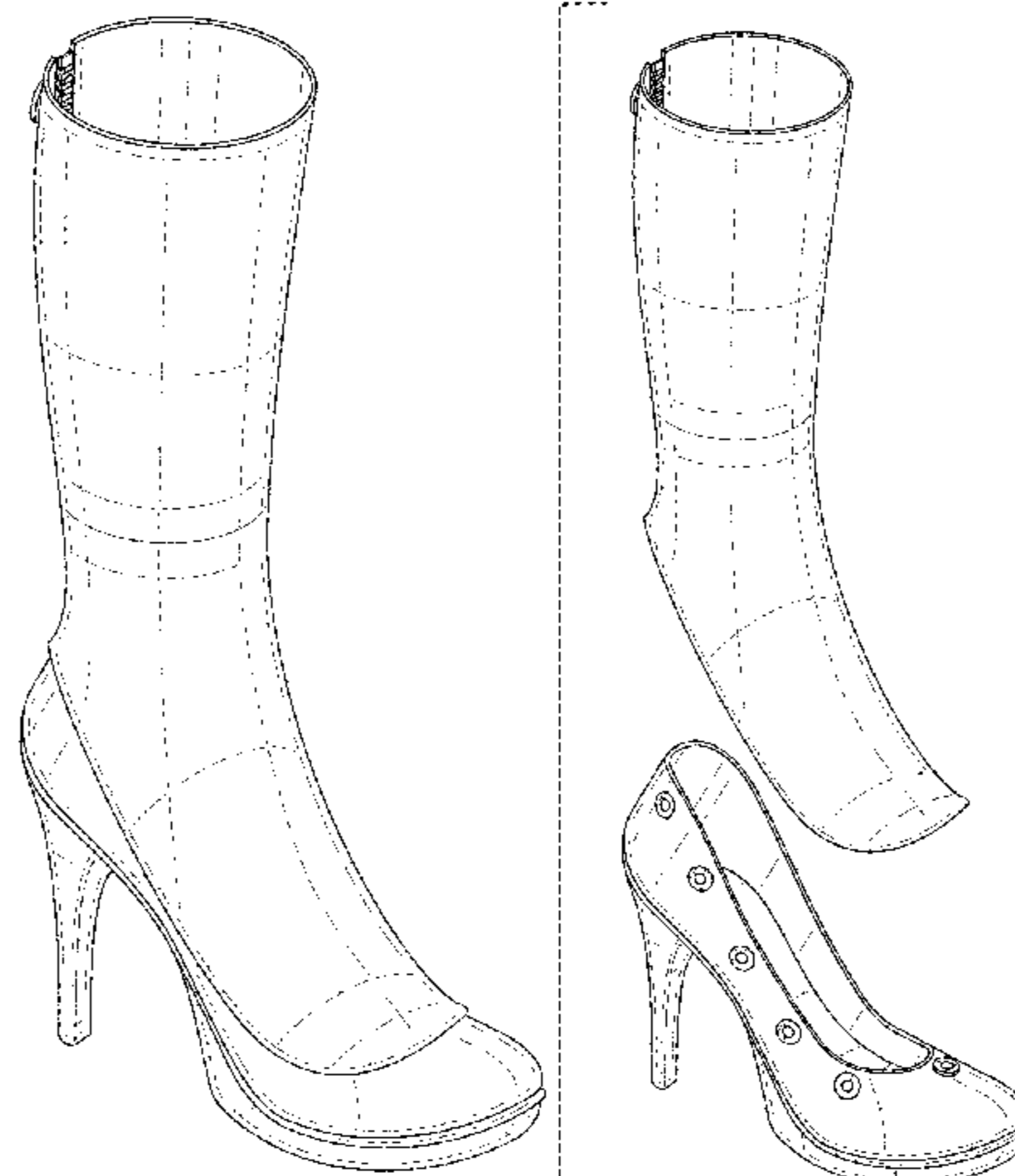

FIG. 16 is an exploded front view of the convertible heel with a detachable leg cover of FIG. 1.

FIG. 17 is an exploded back view of the convertible heel with a detachable leg cover of FIG. 1 showing the detachable leg cover unzipped; and,

FIG. 18 is an exploded front view of the convertible heel with a detachable leg cover of FIG. 1 showing the detachable leg cover unzipped.

1 Claim, 18 Drawing Sheets

(58) **Field of Classification Search**

USPC 36/1.5, 3 A, 83, 45, 99, 101, 112–116,
36/136
CPC A43B 23/00; A43B 23/02; A43B 23/04;
A43B 23/07; A43B 23/024; A43B
23/0245; A43B 23/025; A43B 23/026;
A43B 23/265; A43B 23/14; A43B 23/16;
A43B 23/24; A43B 23/26; A43B 5/00;
A43B 5/001; A43B 5/002; A43B 5/003;
A43B 5/008; A43B 5/06; A43B 5/08;
A43B 5/10; A43B 5/12; A43B 5/14;
A43B 5/145; A43B 1/00; A43B 1/02;
A43B 1/04; A43B 1/0045; A43B 3/12;
A43B 7/00; A43B 9/00; A43B 9/08;
A43B 9/14; A43B 9/16; A43B 11/00;
A43B 21/00; A43B 21/02; A43B 21/04;
A43B 21/06; A43C 1/00; A43C 1/003;
A43C 1/06; A43C 3/00; A43C 5/00;
A43C 7/00; A43C 11/00

See application file for complete search history.

(56) **References Cited**

U.S. PATENT DOCUMENTS

D169,889 S * 6/1953 Bollenbach D2/901
D256,178 S * 8/1980 Rigon D2/910
D270,869 S * 10/1983 Kronberg D2/901
D354,615 S * 1/1995 Parker D2/901
D369,016 S * 4/1996 Parker D2/911
D449,152 S 10/2001 Besko
D501,074 S * 1/2005 Kelsey D2/971
D526,113 S * 8/2006 Choi D2/909
D527,872 S * 9/2006 Choi D2/910

D528,269 S * 9/2006 Smith, III D2/901
D529,689 S * 10/2006 Choi D2/911
D530,488 S * 10/2006 Kelsey D2/912
D532,192 S * 11/2006 Choi D2/972
D555,335 S * 11/2007 He D2/909
D557,482 S * 12/2007 Kelsey D2/912
D561,432 S * 2/2008 He D2/911
D562,534 S * 2/2008 Der D2/910
D585,186 S * 1/2009 Van Hulle D2/910
D585,633 S * 2/2009 Lawler D2/929
D586,983 S * 2/2009 Van Hulle D2/910
D599,981 S * 9/2009 Kim D2/901
D627,543 S * 11/2010 Wolff D2/910
D632,877 S * 2/2011 Adams D2/910
D643,611 S * 8/2011 Ringholz D2/970
D655,896 S * 3/2012 Kang D2/901
D666,800 S 9/2012 Edwards
D685,172 S * 7/2013 Warner D2/970
8,863,406 B2 10/2014 Moore
D718,022 S * 11/2014 Shelton D2/901
D735,981 S * 8/2015 Louboutin D2/939
D757,406 S 5/2016 Stillwagon
D760,908 S * 7/2016 MacNeil D24/190
D764,158 S * 8/2016 McClaskie D2/971
D768,371 S * 10/2016 McClaskie D2/970
D770,157 S * 11/2016 McClaskie D2/970
D782,787 S * 4/2017 Jankowski D2/901
D783,952 S * 4/2017 Oppici D2/910
D822,955 S * 7/2018 Jankowski D2/901
D822,956 S * 7/2018 Jankowski D2/901
10,159,300 B2 12/2018 Muhammad
2010/0186259 A1 7/2010 Garza
2011/0078919 A1 4/2011 Yang

OTHER PUBLICATIONS

Black PU Removable Upper Knee High Heeled Boots, PrettyLittleThing.us, [online], [site visited Sep. 29, 2021]. <URL: <https://www.prettylittlething.us/black-pu-removable-upper-knee-high-heeled-boots.html>> (Year: 2021).*

Teeze-31G, Detachable Shaft Glitter Pump, FunkyPair.com, [online], [site visited Sep. 29, 2021]. <URL: <https://www.funkypair.com/bordello-teeze-31g-detachable-shaft-glitter-pump/>> (Year: 2021).*

COPOZZ Leg Gaiters Waterproof Snow Boot Shoe Gaiters Leg Cover for Men and Women, Perfect for Outdoor Hunting Hiking Backpacking Skiing Trimming Grass, Amazon.com, Date First Available: Jul. 1, 2019, [online], [site visited Sep. 29, 2021]. <URL: <https://www.amazon.com/COPOZZ-Gaiters-Waterproof-Backpacking-Trimming/dp/B07TT6FNGX?th=1>> (Year: 2019).*

* cited by examiner



FIG. 1

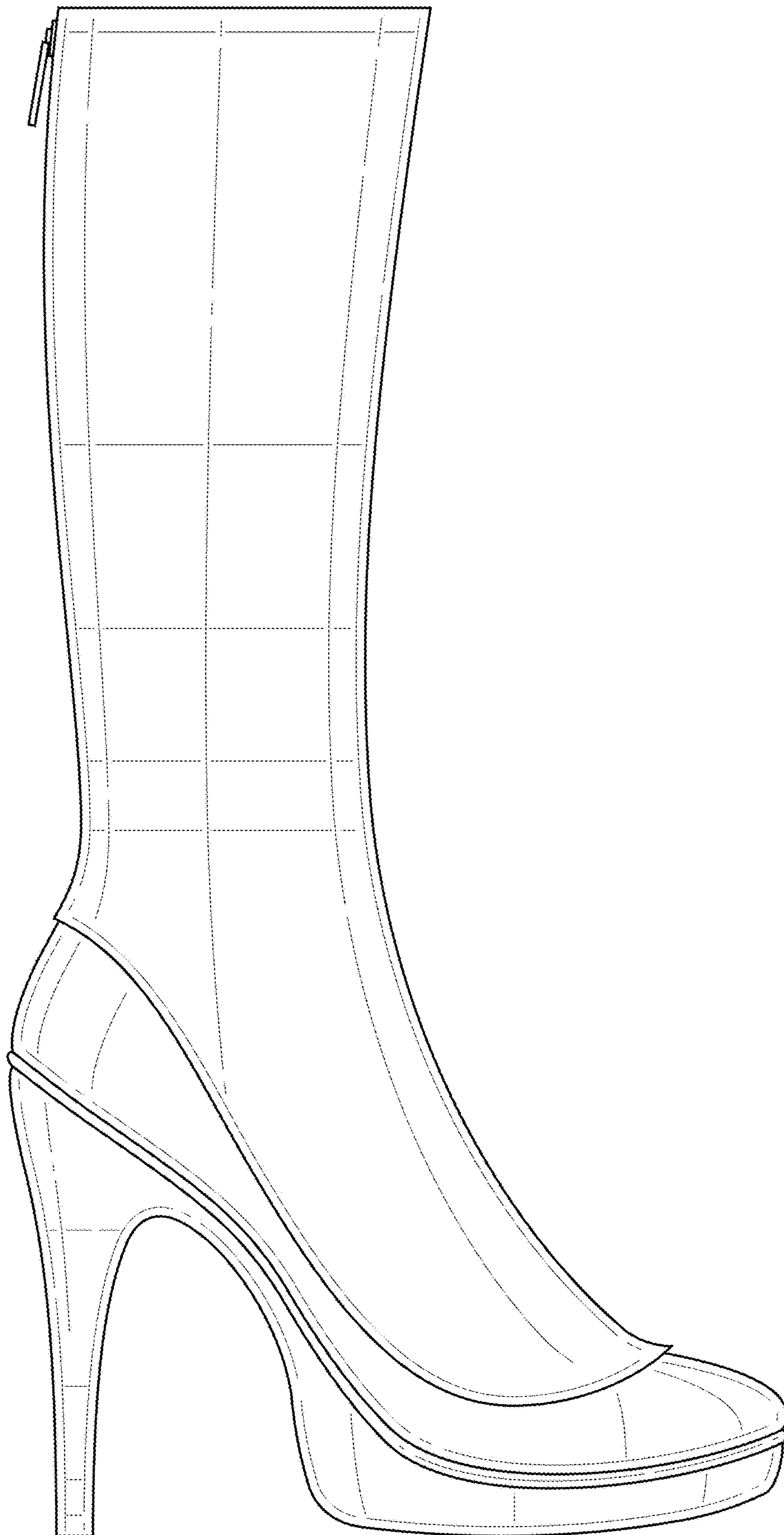

FIG. 2

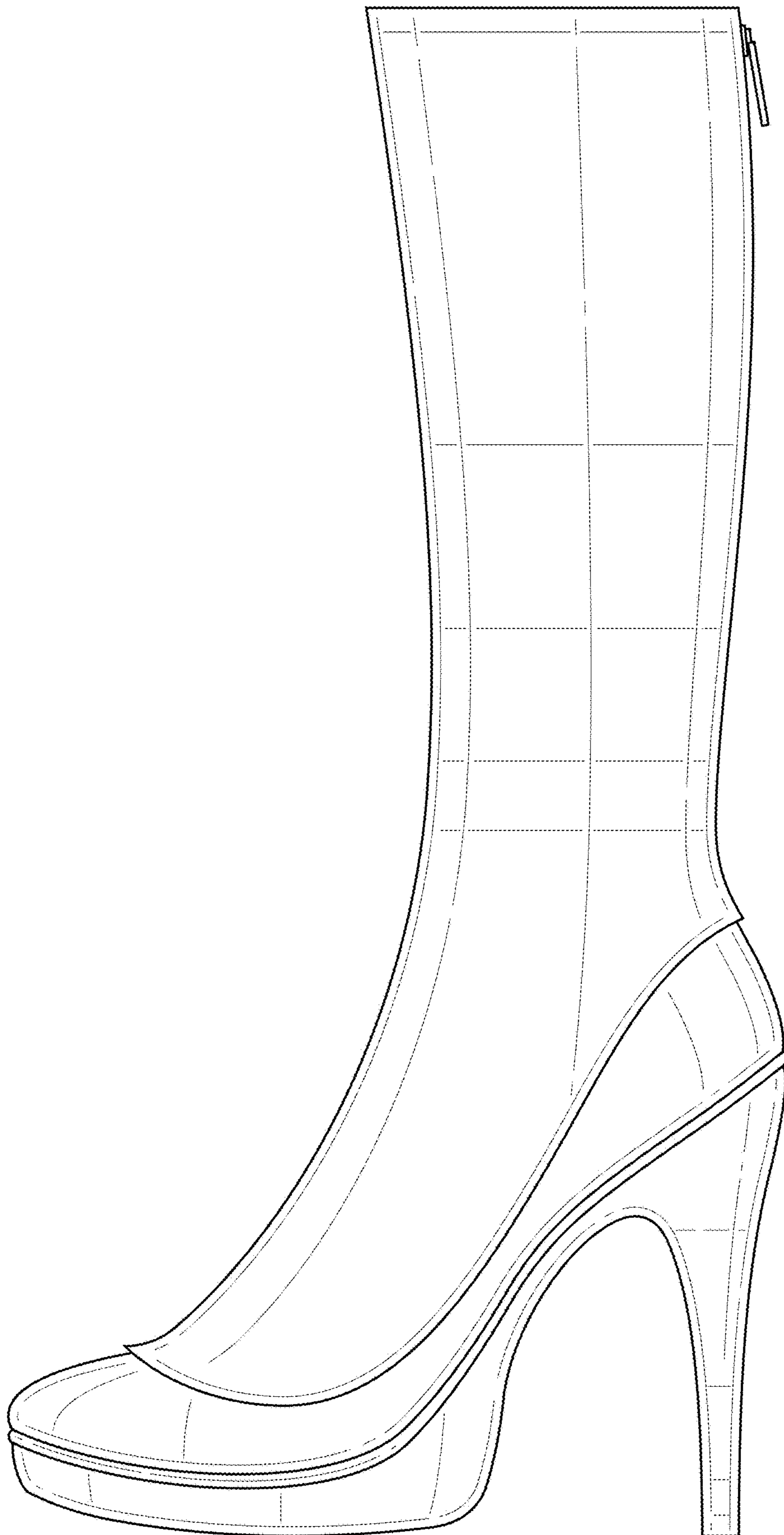

FIG. 3

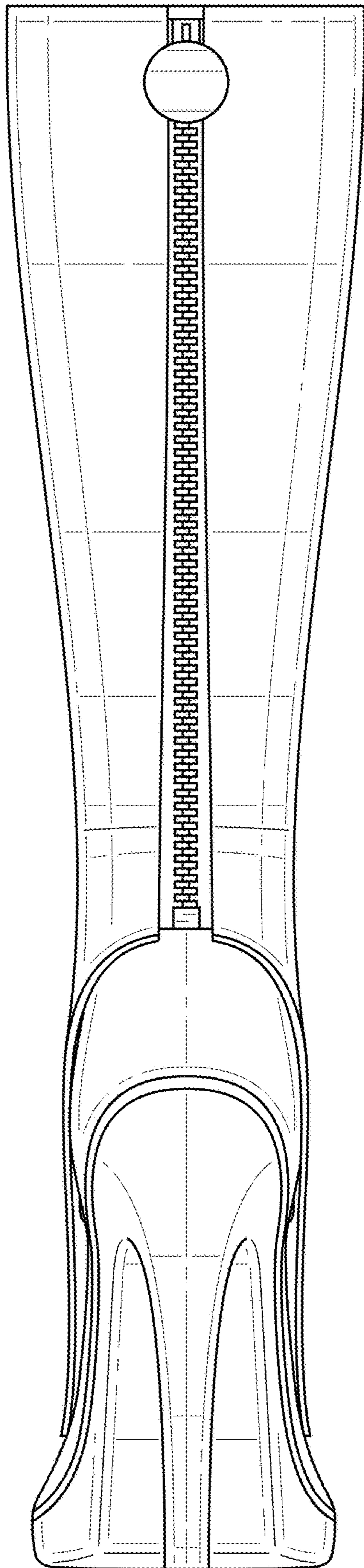

FIG. 4

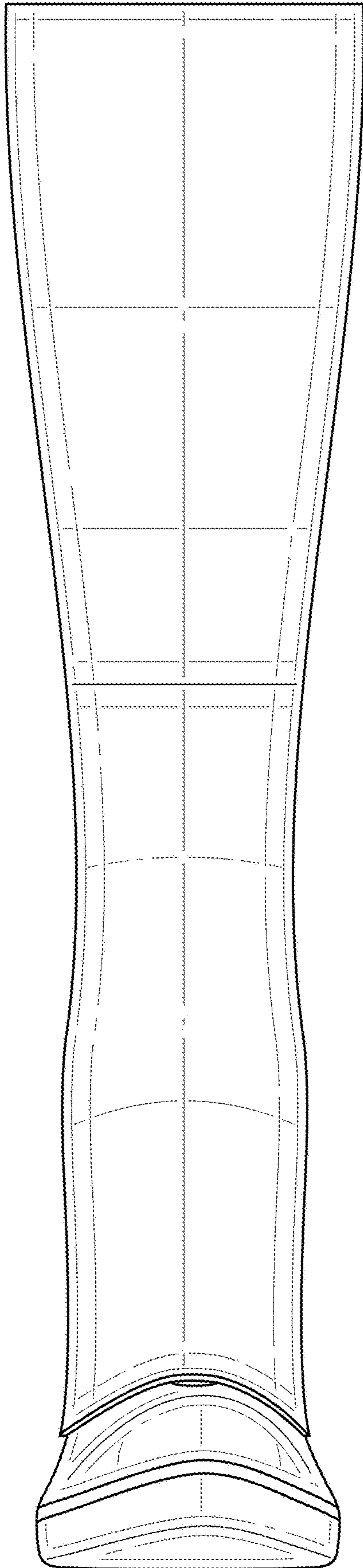

FIG. 5

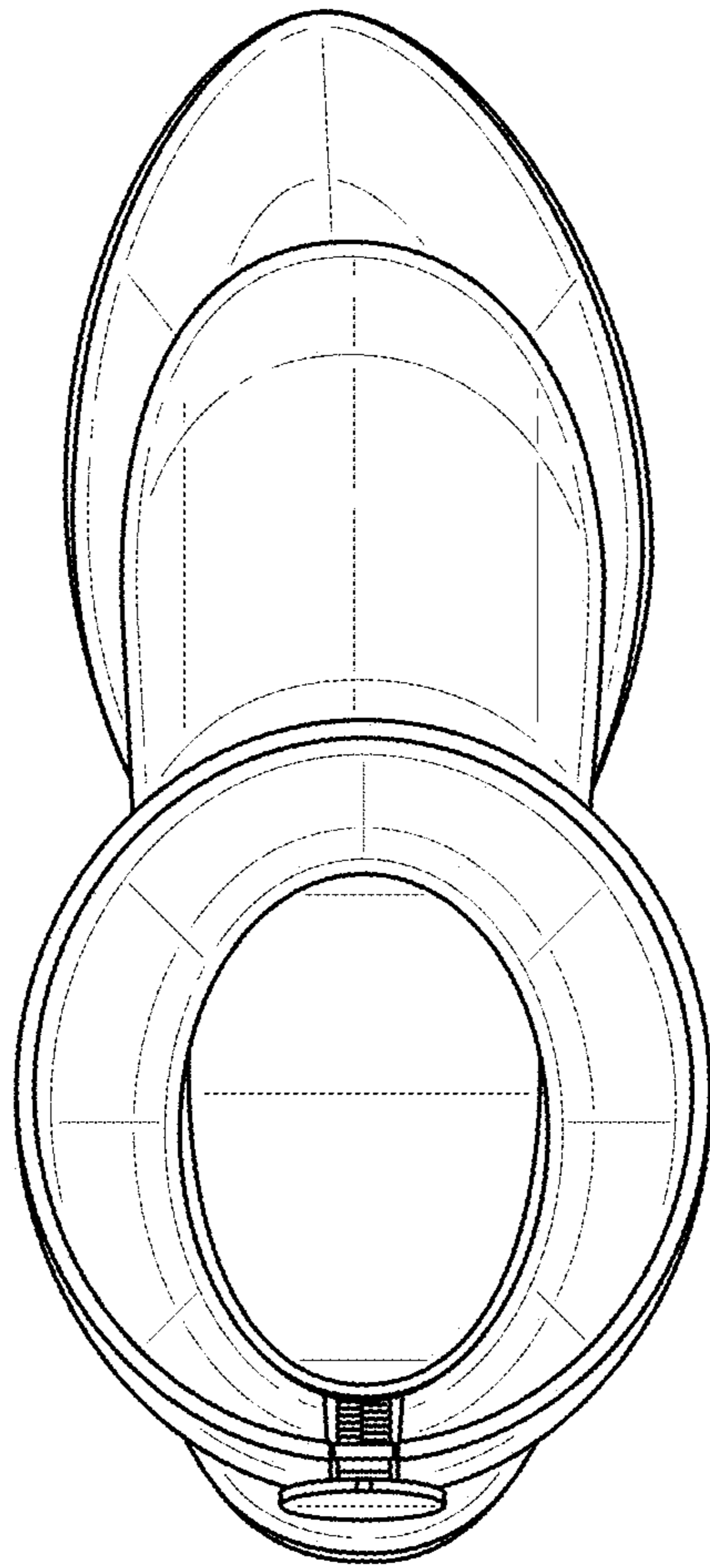

FIG. 6

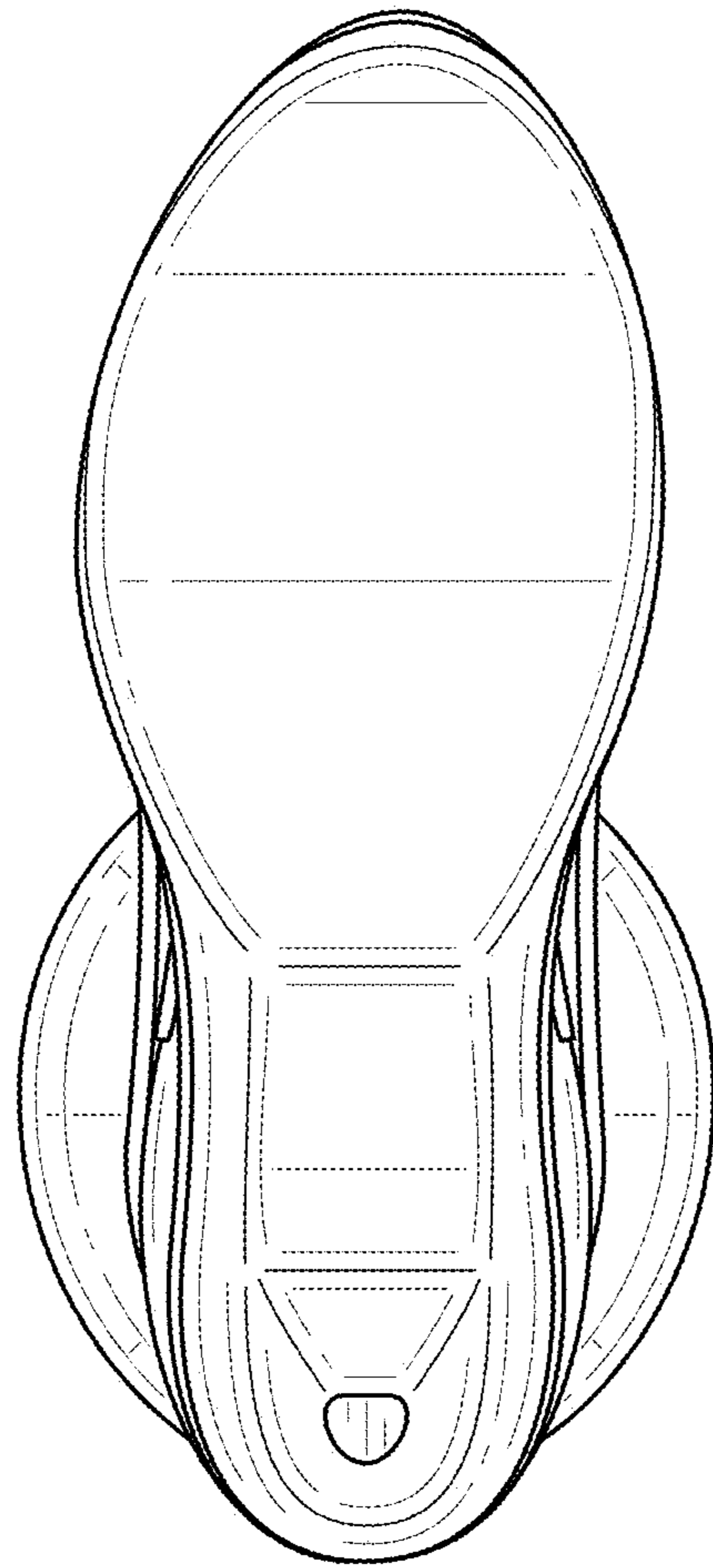

FIG. 7

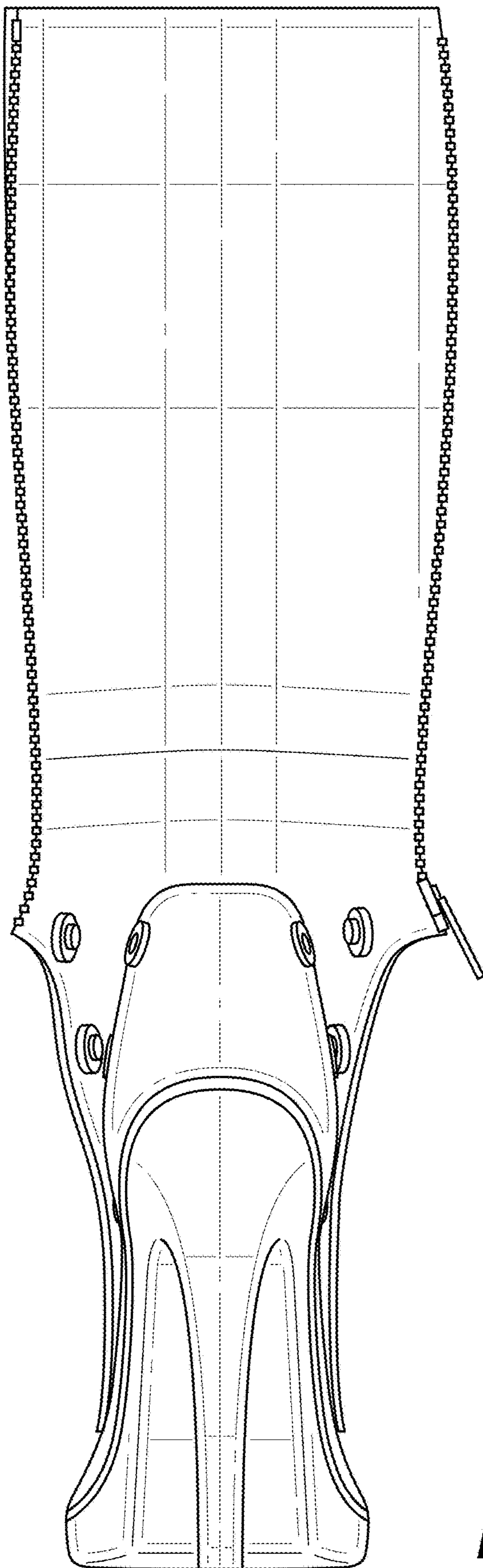

FIG. 8

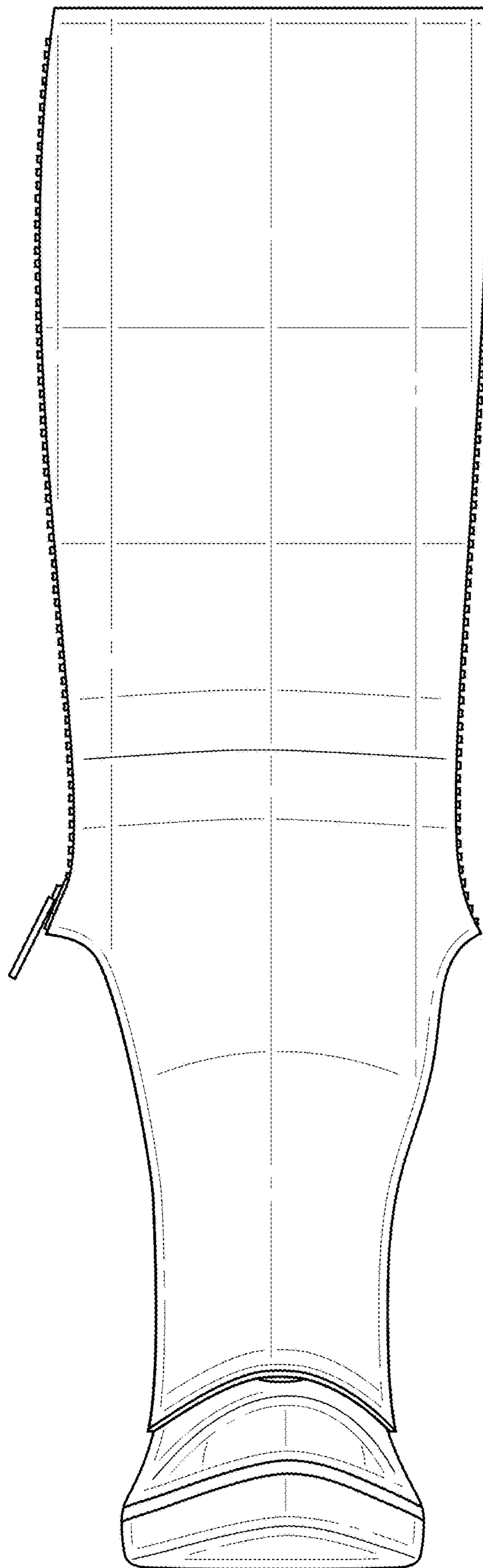

FIG. 9

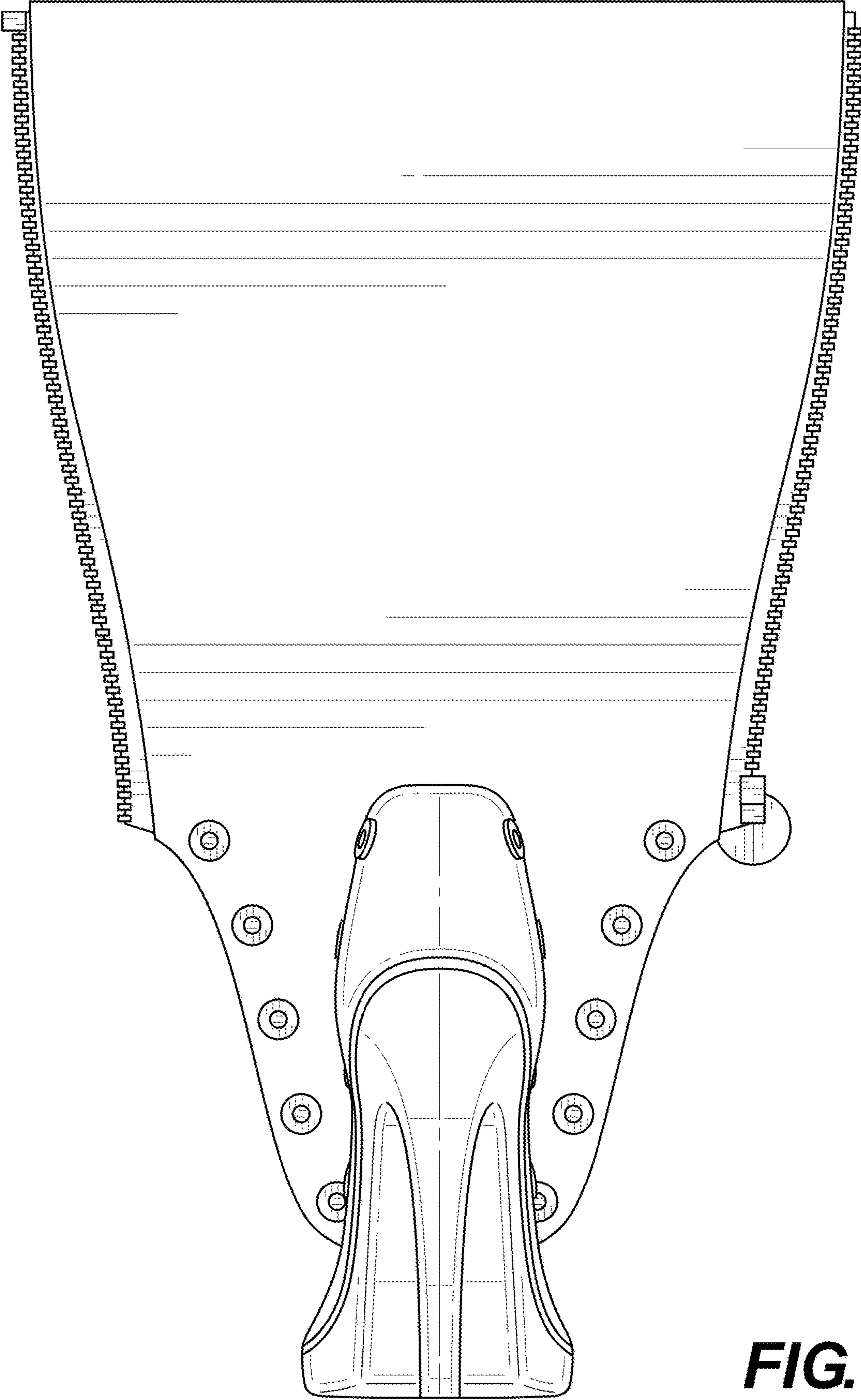

FIG. 10

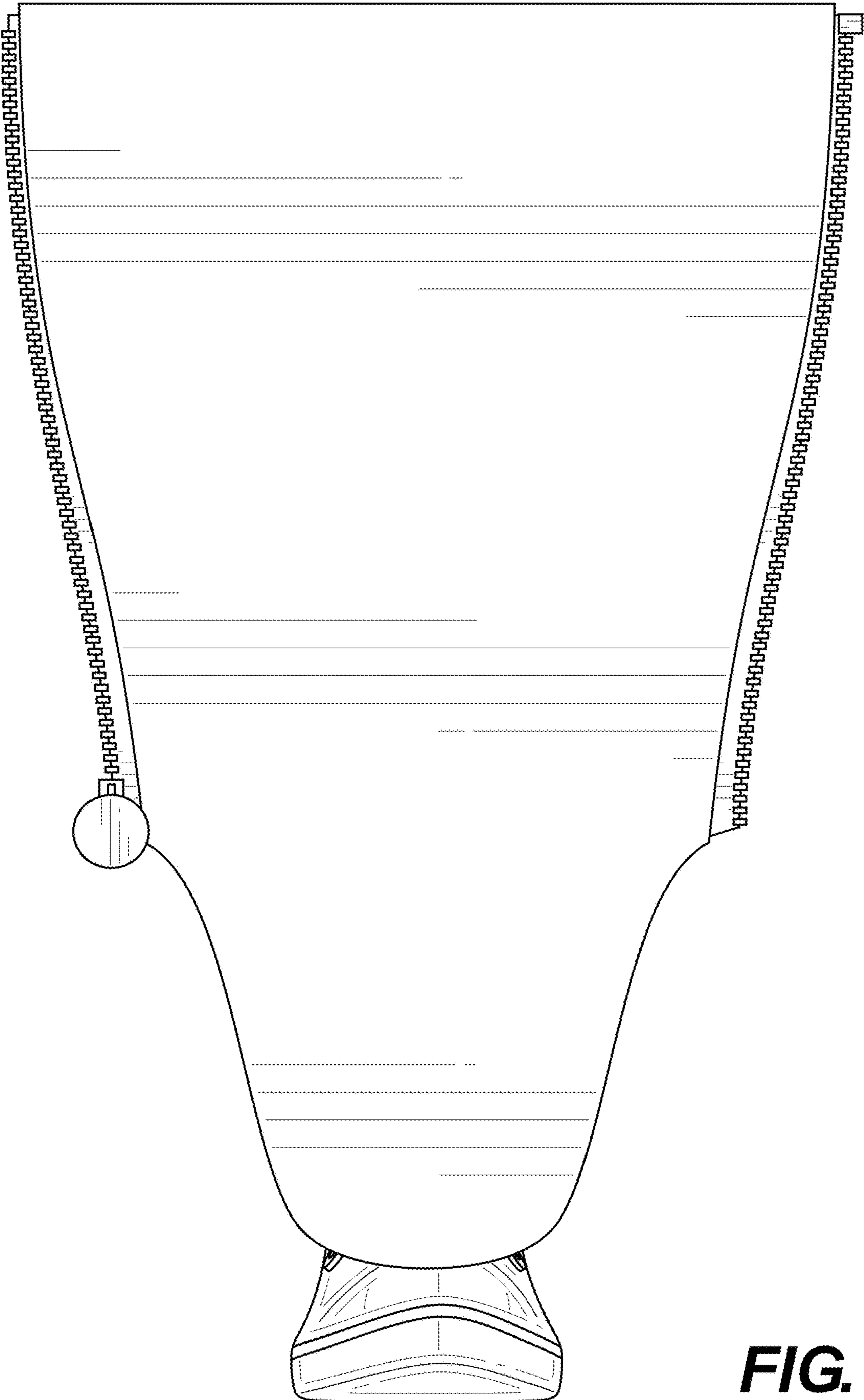

FIG. 11

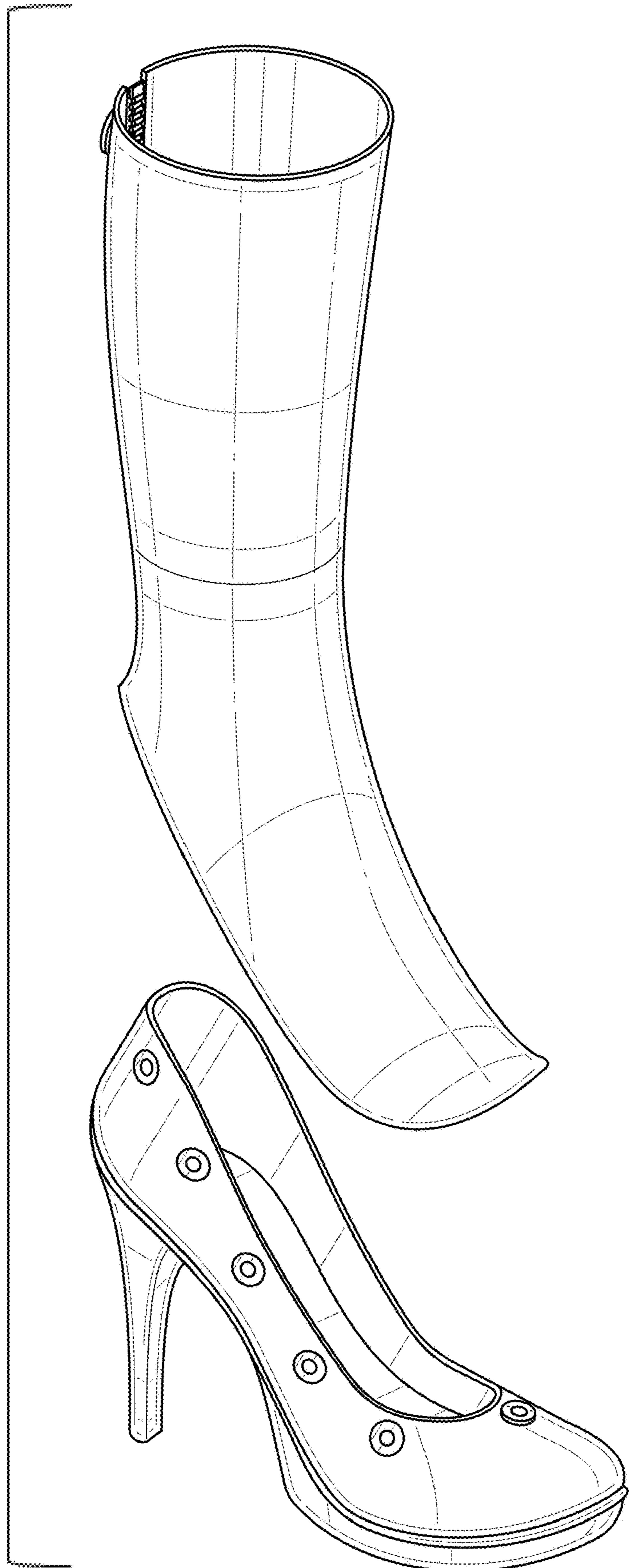

FIG. 12

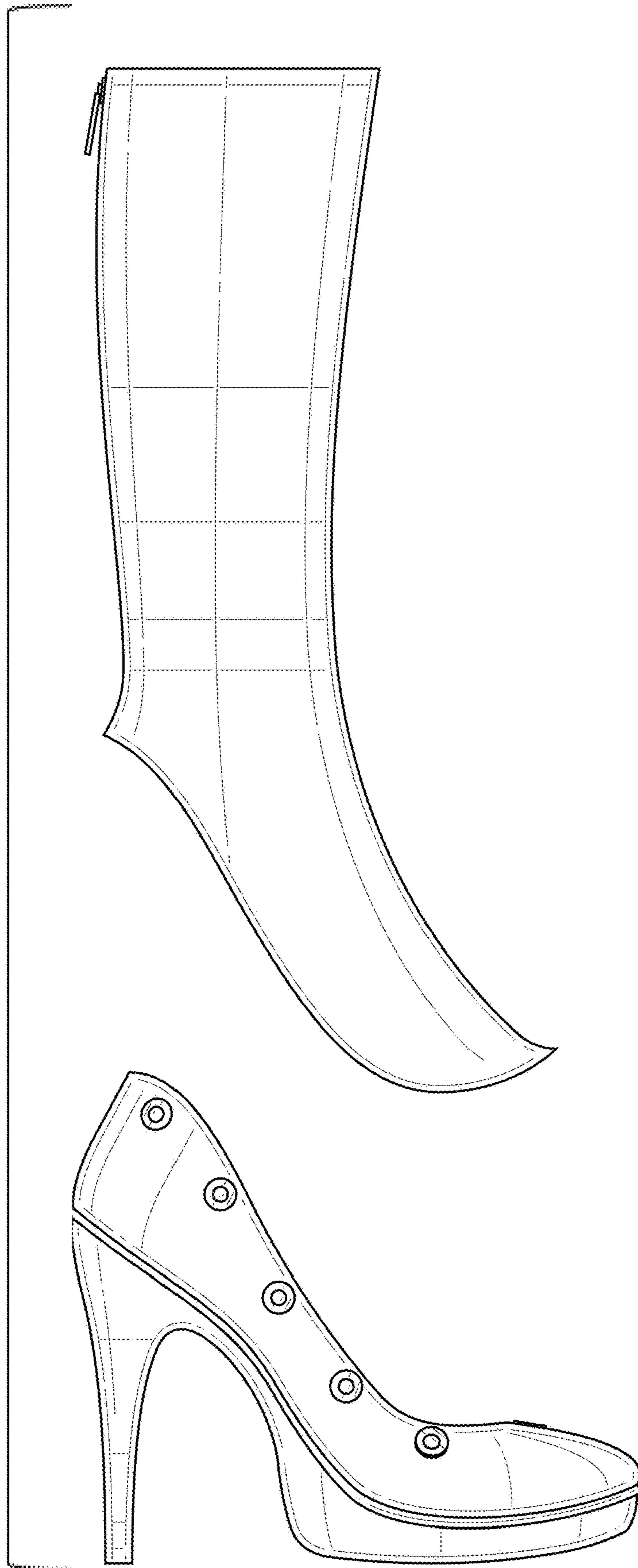

FIG. 13

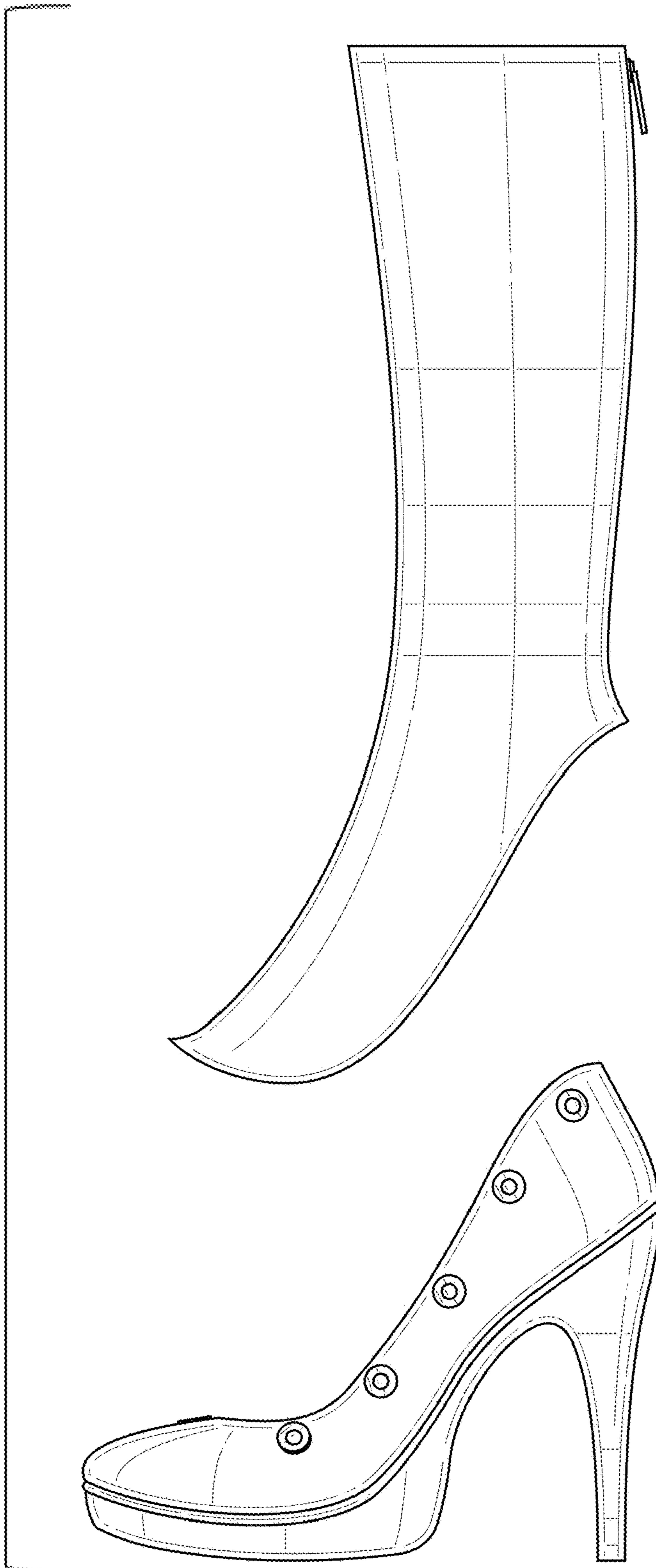

FIG. 14

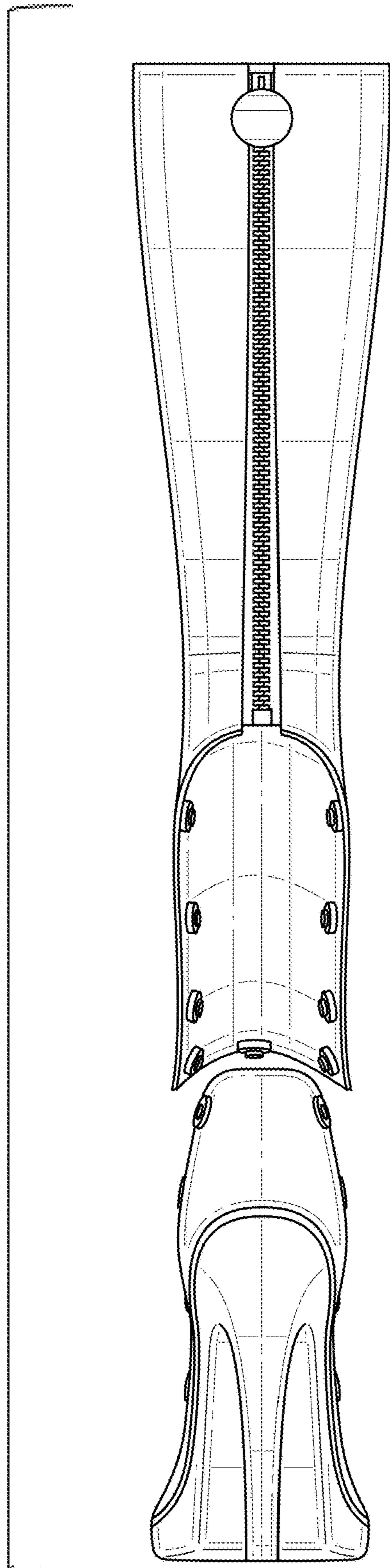

FIG. 15

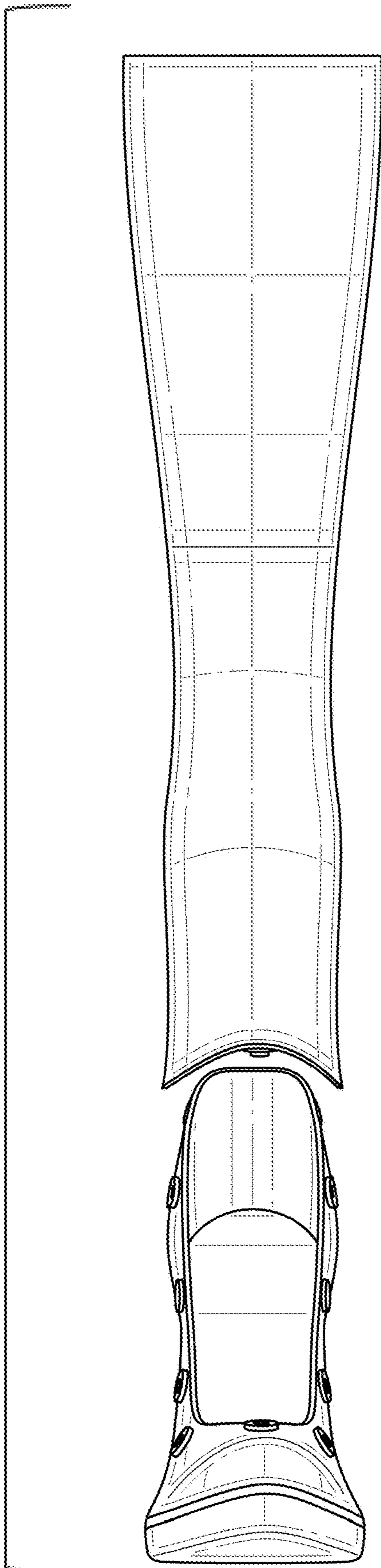

FIG. 16

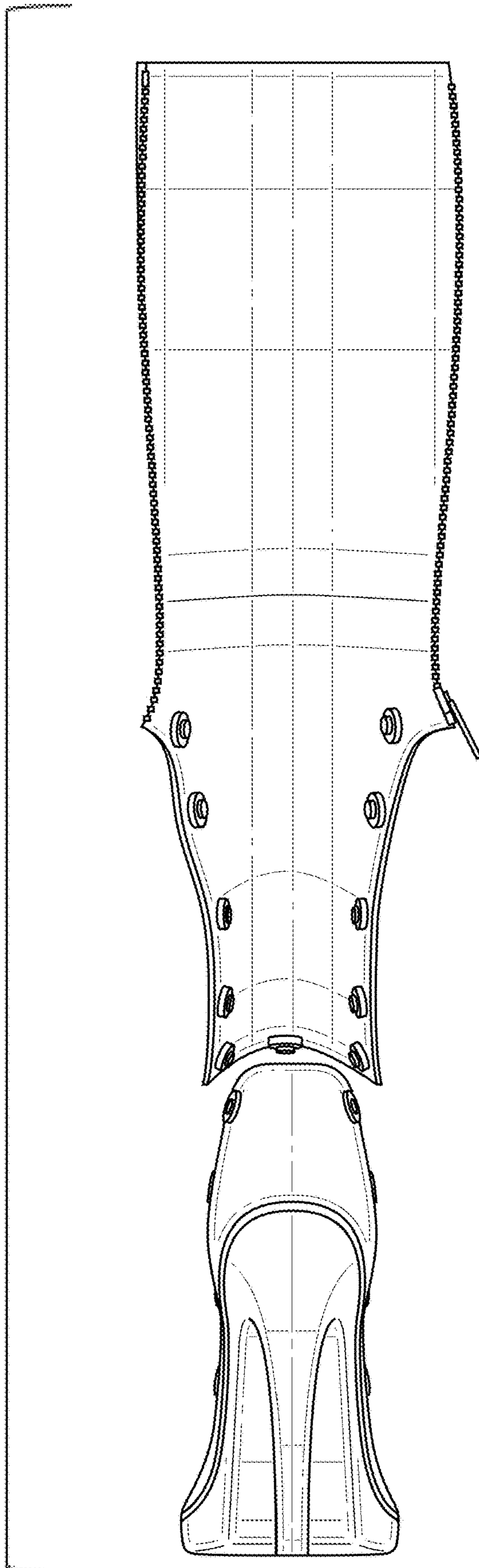

FIG. 17

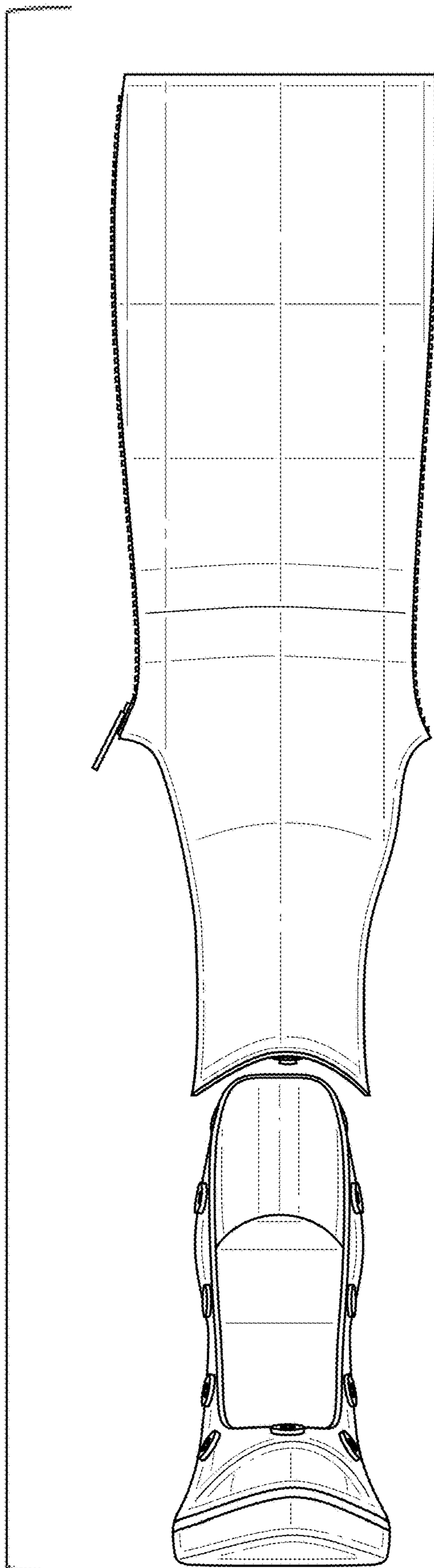

FIG. 18