



US00D953660S

(12) **United States Design Patent** (10) **Patent No.:** **US D953,660 S**
Favia (45) **Date of Patent:** **** May 31, 2022**

- (54) **GROOMING HAIR ACCUMULATOR FOR ANIMAL**
- (71) Applicant: **Spectrum Brands, Inc.**, Middleton, WI (US)
- (72) Inventor: **Adam Favia**, Reedsburg, WI (US)
- (73) Assignee: **Spectrum Brands, Inc.**, Middleton, WI (US)
- (**) Term: **15 Years**
- (21) Appl. No.: **29/758,490**
- (22) Filed: **Nov. 16, 2020**

Related U.S. Application Data

- (63) Continuation of application No. 29/641,266, filed on Mar. 20, 2018, now Pat. No. Des. 902,502.
- (51) **LOC (13) Cl.** **30-99**
- (52) **U.S. Cl.**
USPC **D30/158**
- (58) **Field of Classification Search**
USPC D30/158, 159; D4/116-123, 127-129, D4/130-138, 199; D32/40, 52
See application file for complete search history.

(56) **References Cited**

U.S. PATENT DOCUMENTS

D285,130 S	8/1986	Wilkeson
6,367,422 B1	4/2002	Wilhelmi
D577,204 S	9/2008	Libman et al.
D580,657 S	11/2008	Libman et al.
D586,561 S	2/2009	Libman et al.

D591,513 S	5/2009	McNeil et al.
D632,087 S	2/2011	Wang
D743,703 S	11/2015	Harrington et al.
D759,384 S	6/2016	Libman et al.
D847,515 S	5/2019	Renner et al.
D853,128 S	7/2019	Tschopp
D857,399 S	8/2019	Renner et al.
D902,502 S *	11/2020	Favia D30/158
2014/0158151 A1	6/2014	Sebagereka et al.

* cited by examiner

Primary Examiner — Michael C Stout

Assistant Examiner — Katrina N Gonzalez

(74) *Attorney, Agent, or Firm* — Merchant & Gould P.C.

(57) **CLAIM**

The ornamental design for a grooming hair accumulator for animal, as shown and described.

DESCRIPTION

FIG. 1 is a top perspective view of the new design; FIG. 2 is a bottom perspective view of the new design; FIG. 3 is a top view of the new design; FIG. 4 is a bottom view of the new design; FIG. 5 is a right side view the new design, the left side view being a mirror image thereof; FIG. 6 is another perspective view, but shown with the handle and head separated for completeness of illustration; FIG. 7 is another perspective view, but shown with the handle removed for completeness of illustration; FIG. 8 is another perspective view thereof; and, FIG. 9 is another perspective view thereof.

The broken lines illustrate portions of the grooming hair accumulator for animal that forms no part of the claimed design.

1 Claim, 9 Drawing Sheets

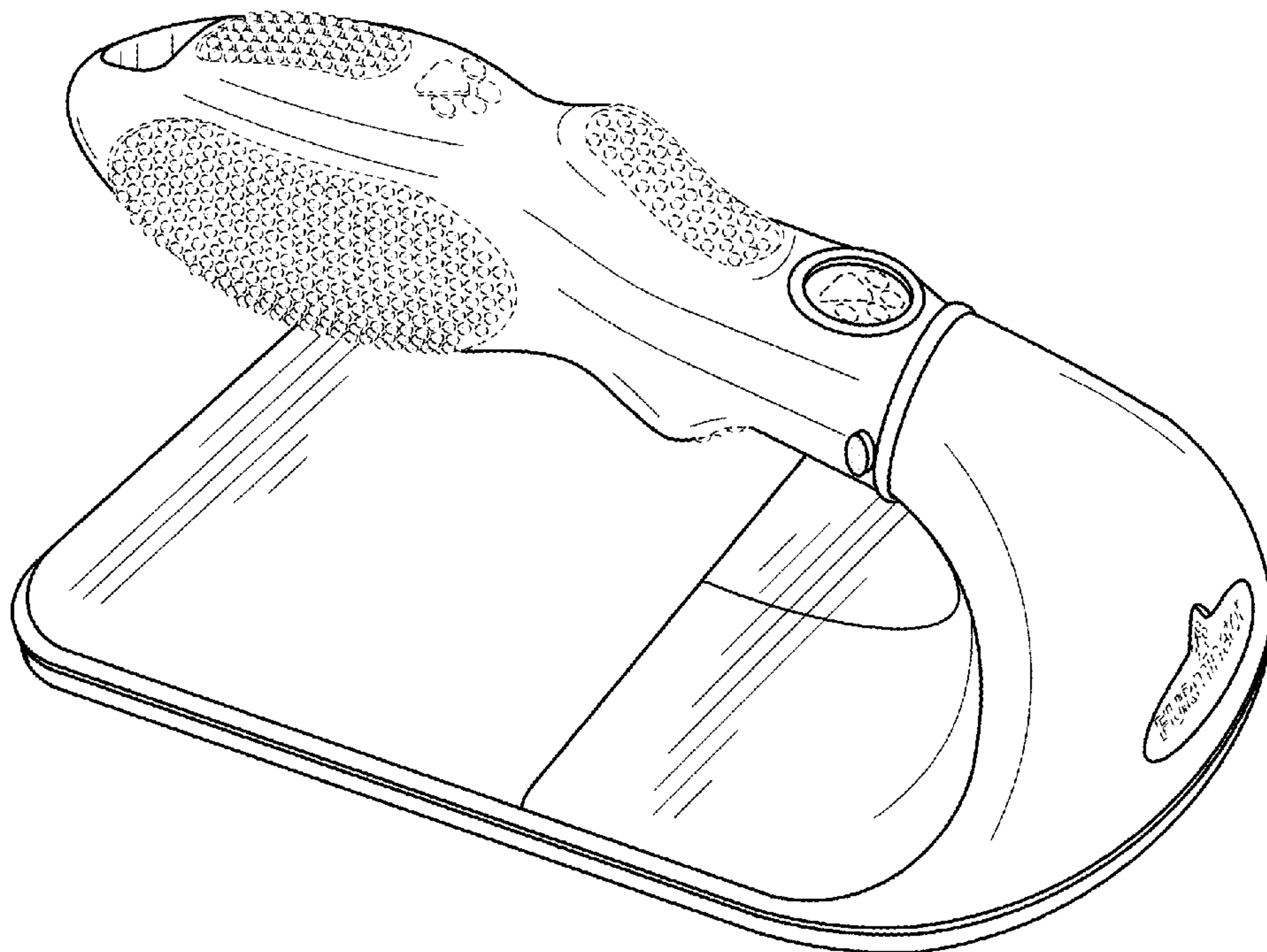

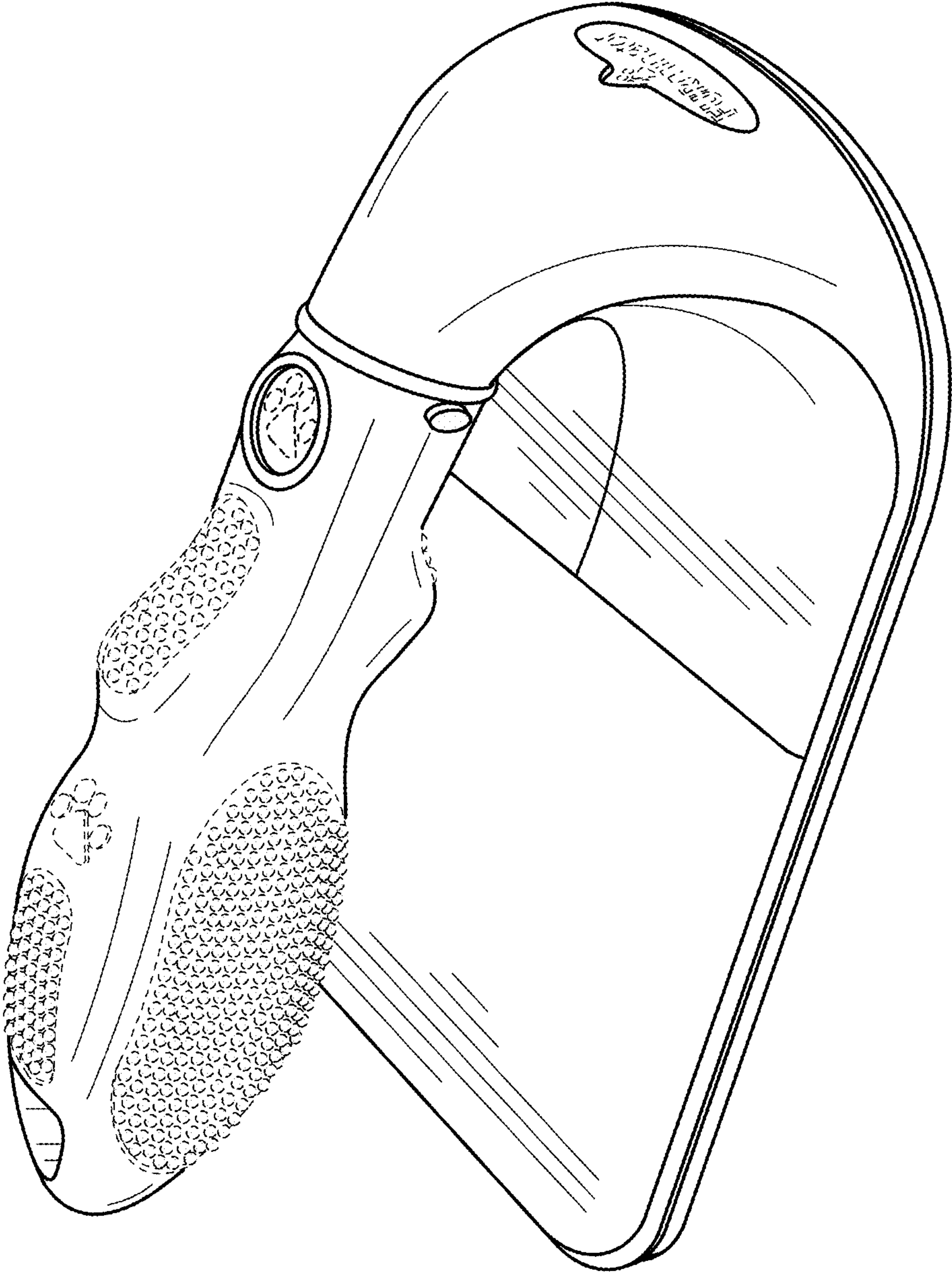

FIG. 1

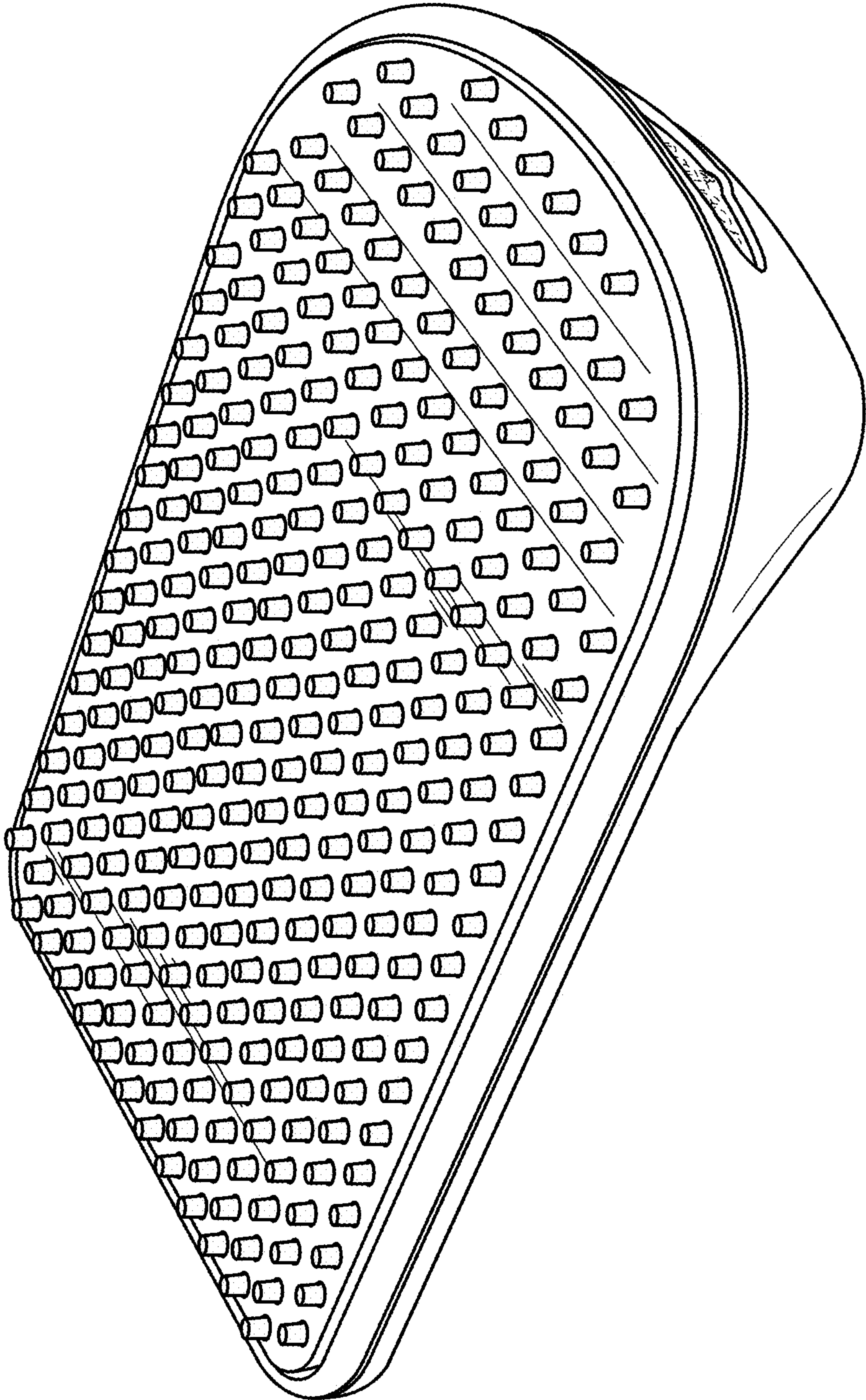

FIG. 2

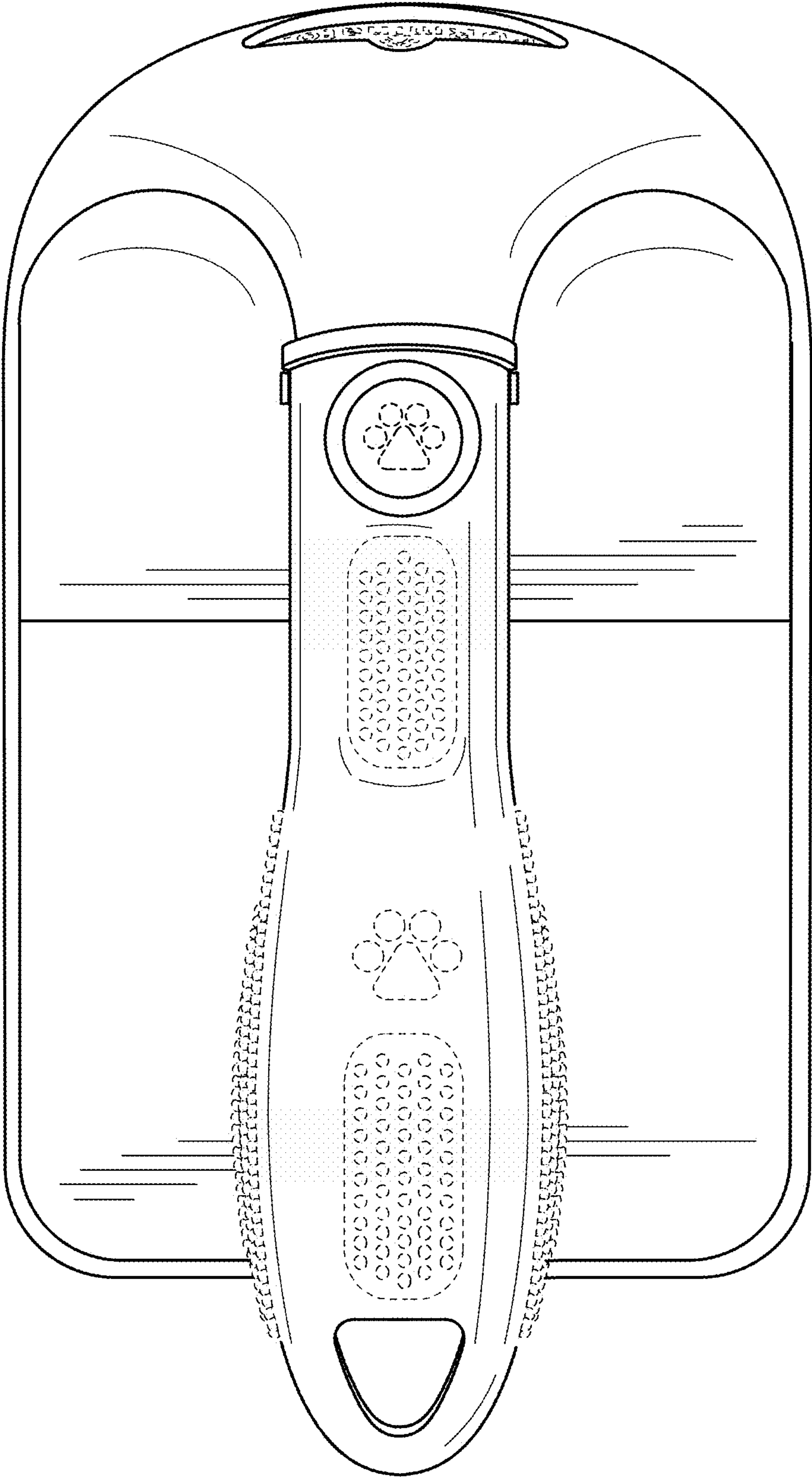

FIG. 3

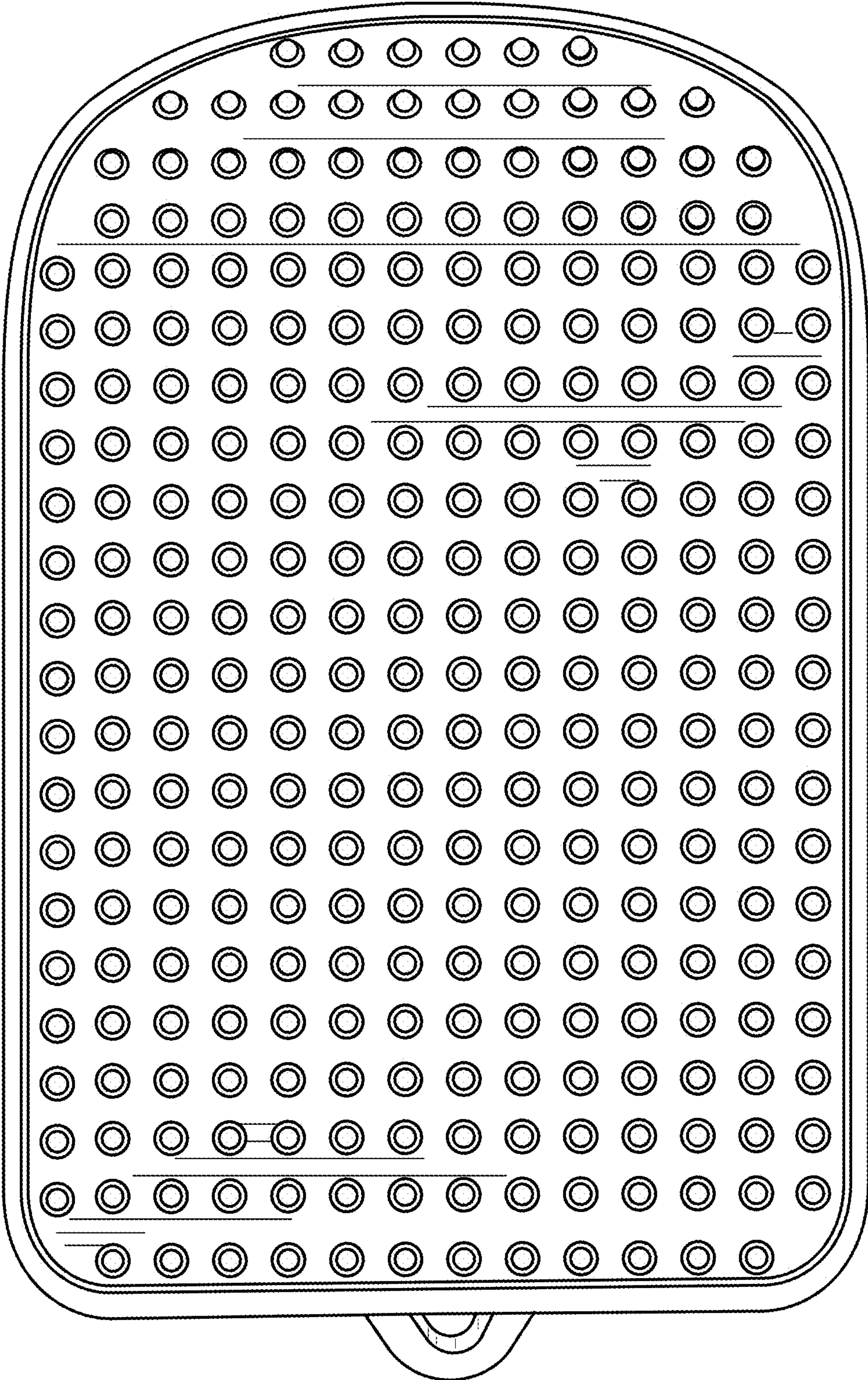

FIG. 4

FIG. 5

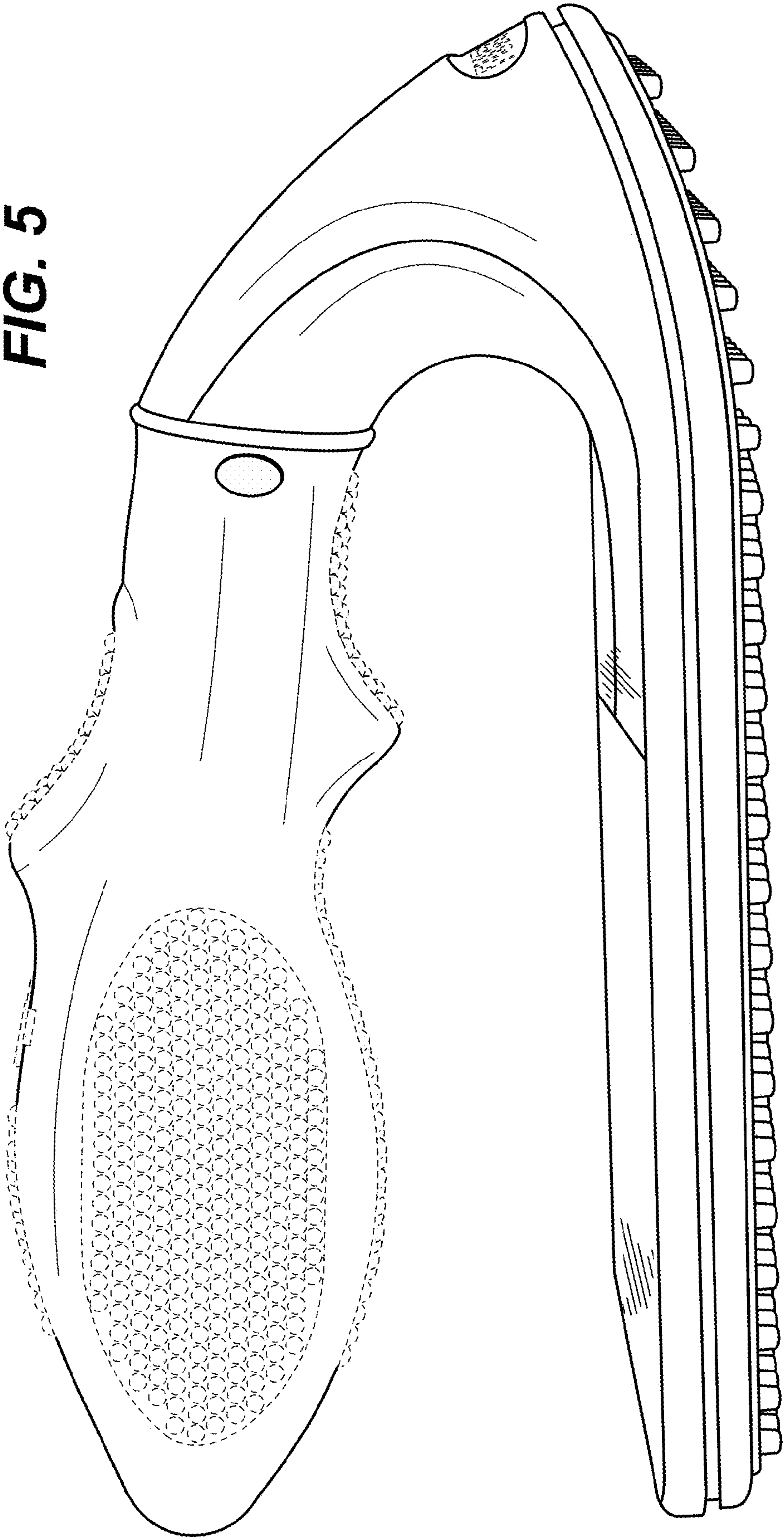
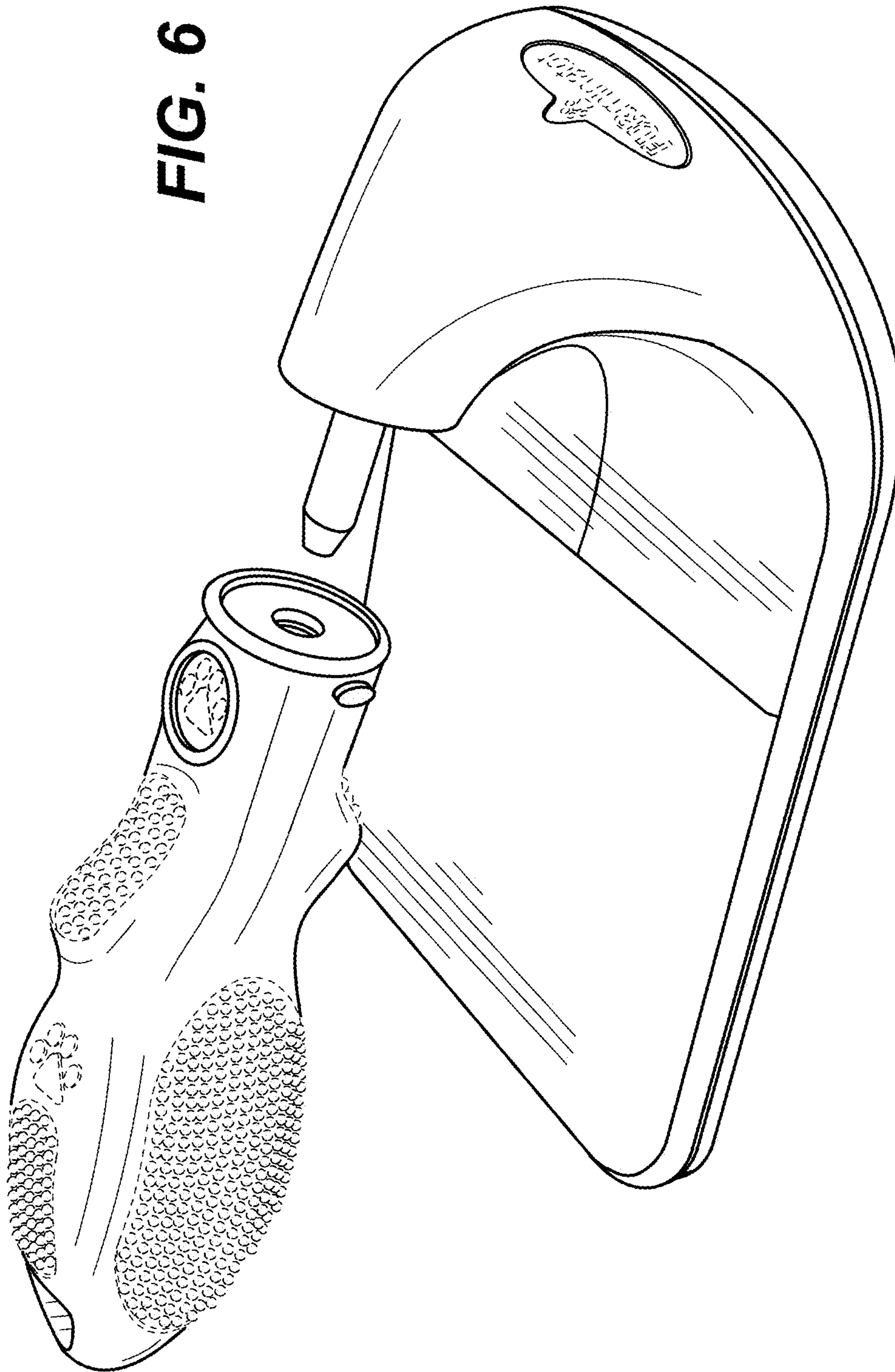

FIG. 6



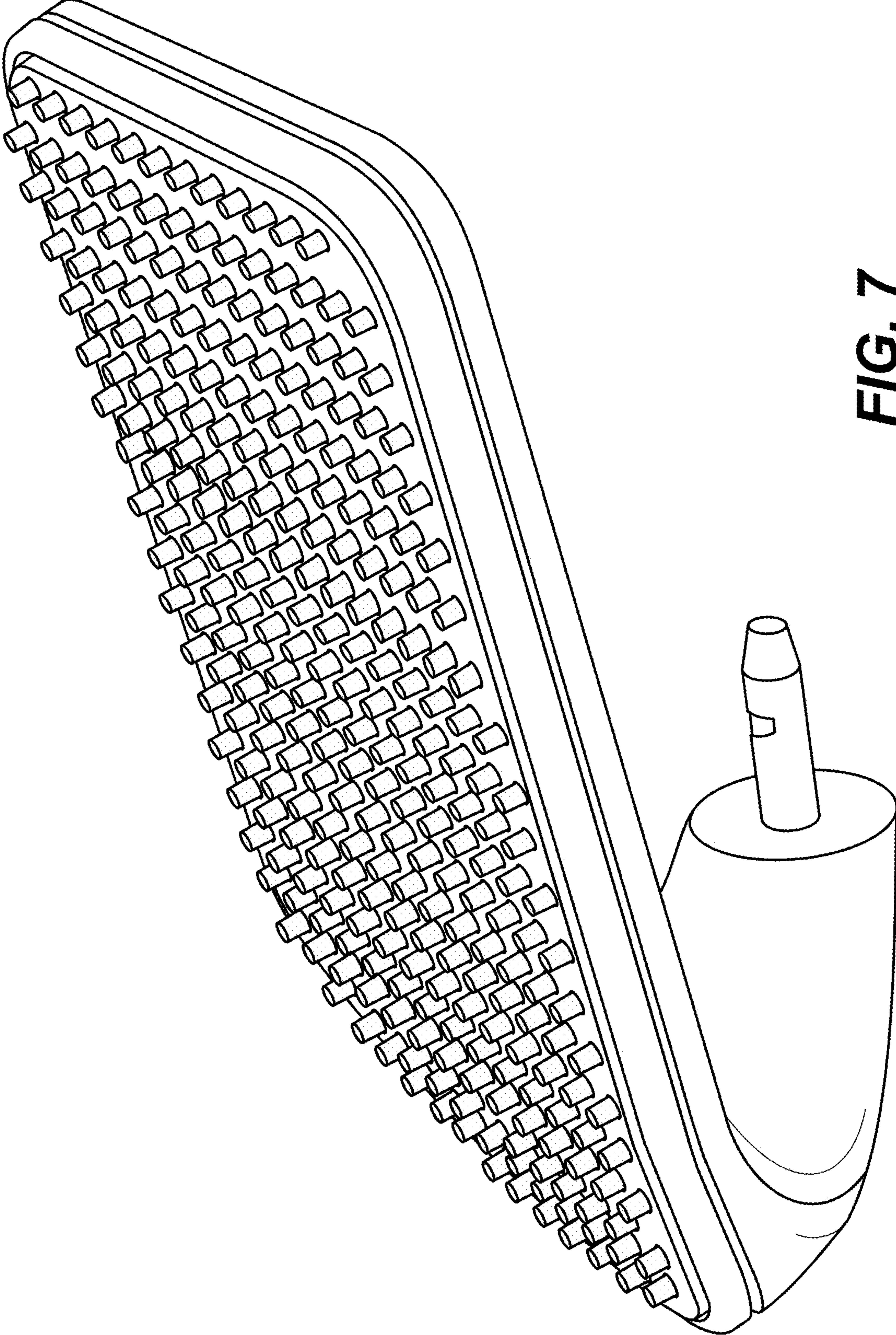

FIG. 7

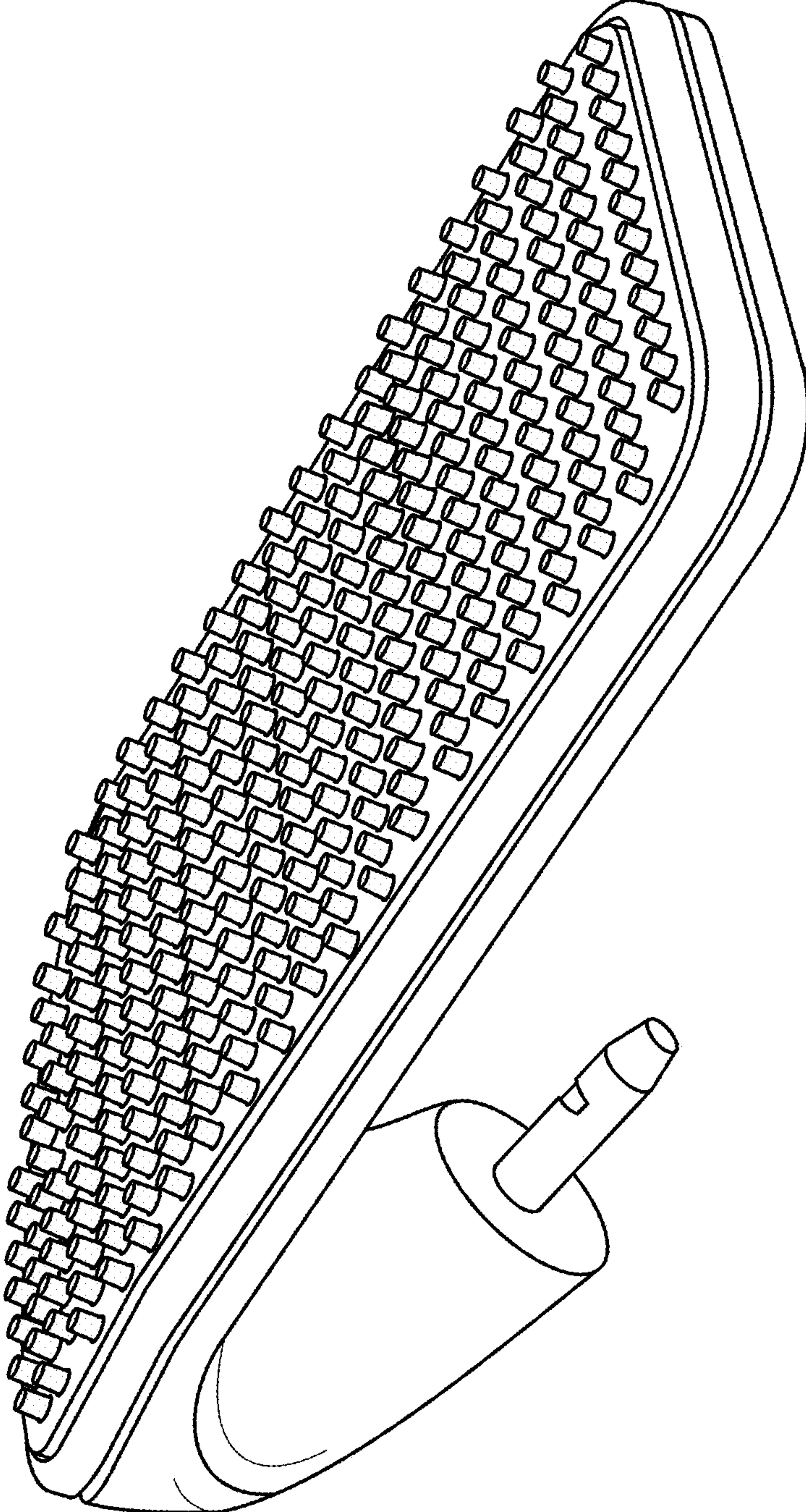

FIG. 8

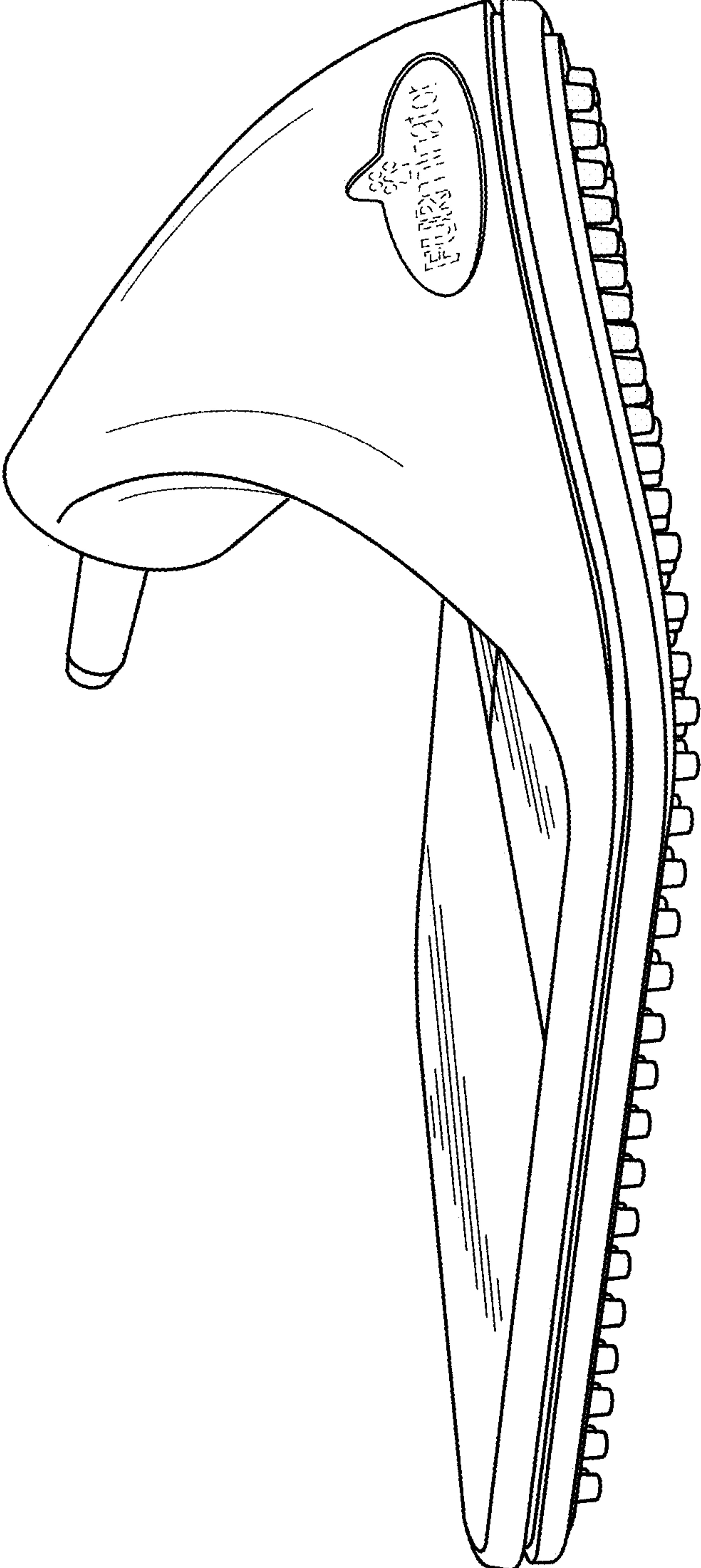

FIG. 9